

LELAND

# Omena

## Specifications & Finishes



January 2024

# Omena

## Side Chair

LELAND

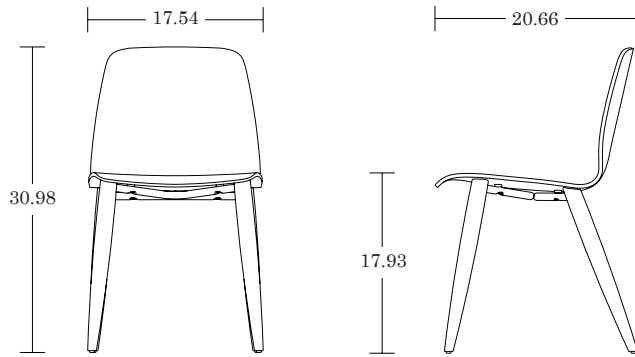

Side Chair / OMSW

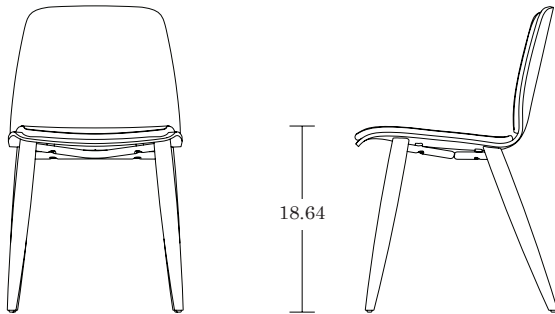

Upholstered Seat / OMSWU



Upholstered Seat and Back / OMSWUU

## SPECIFICATIONS

### Veneer Options

Leland Wood Finishes [View transparent / View semi-transparent](#)

Premium Oak [View here](#)

Gradient Finishes [View here](#)

### Upholstery Options [View here](#)

(Fabric Approval Required)

Camira

Carnegie

Stinson

Green Hides

Maharam

COM/COL

### Glide Options

Standard (Nylon)

Rubber

Felt

### Additional Options

Load Tested to 500+ lbs

## Bar Stool

### SPECIFICATIONS

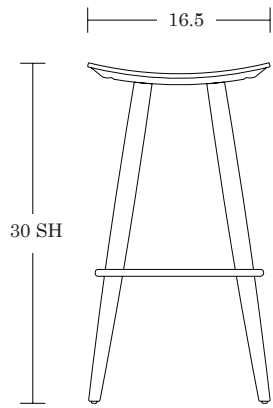

Bar Stool/ OMBW

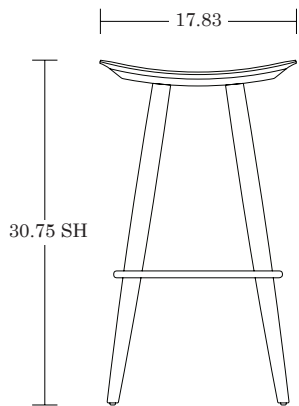
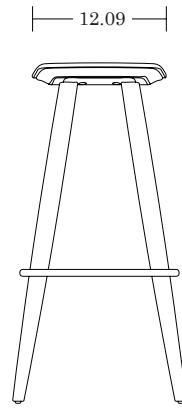

Upholstered Seat / OMBWU

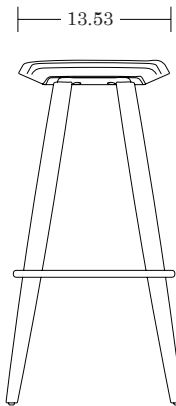

#### Veneer Options

Leland Wood Finishes [View transparent / View semi-transparent](#)  
Premium Oak [View here](#)

#### Upholstery Options [View here](#)

(Fabric Approval Required)

Camira  
Carnegie  
Stinson  
Green Hides  
Maharam  
COM/COL

#### Foot Ring Options [View here](#)

Standard Leland Powdercoats, Textured Powdercoats & Chrome

#### Glide Options

Standard (rubber)  
Felt

# Omena

## Counter Stool

LELAND

### SPECIFICATIONS

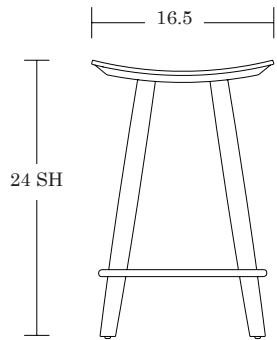

Counter Stool/ OMCW

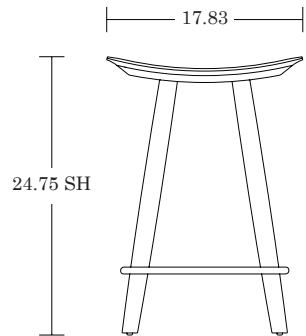
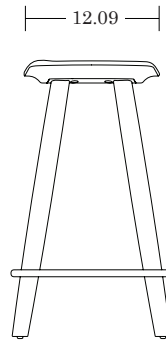

Upholstered Seat / OMCWU

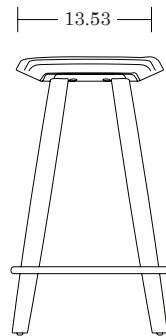

#### Veneer Options

Leland Wood Finishes [View transparent / View semi-transparent](#)  
Premium Oak [View here](#)

#### Upholstery Options [View here](#)

(Fabric Approval Required)

Camira  
Carnegie  
Stinson  
Green Hides  
Maharam  
COM/COL

#### Foot Ring Options [View here](#)

Standard Leland Powdercoats, Textured Powdercoats & Chrome

#### Glide Options

Standard (rubber)  
Felt

# Omena

## Low Stool

LELAND

### SPECIFICATIONS

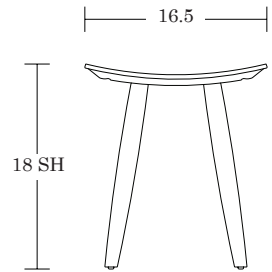

Low Stool/ OMLW

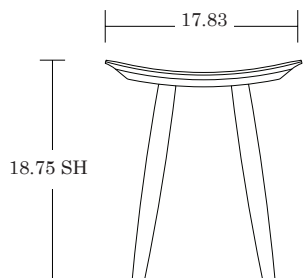
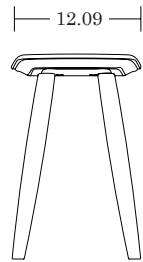

Upholstered Seat / OMLWU

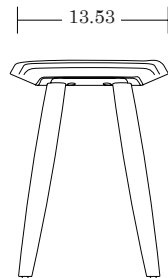

#### Veneer Options

Leland Wood Finishes [View transparent / View semi-transparent](#)

Premium Oak [View here](#)

Gradient Finishes [View here](#)

#### Upholstery Options [View here](#)

(Fabric Approval Required)

Camira

Carnegie

Stinson

Green Hides

Maharam

COM/COL

#### Foot Ring Options [View here](#)

Standard Leland Powdercoats, Textured Powdercoats & Chrome

#### Glide Options

Standard (rubber)

Felt

# Omena

LELAND

Transparent Wood Options; *Semi-Gloss Sheen*



Natural  
(11M)

## TRANSPARENT WOOD STAIN OPTIONS ON MAPLE VENEER



Neutral  
(15M)



Medium  
(13M)



Classic  
Mahogany  
(21M)

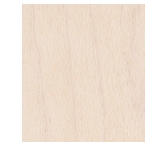

White Wash II  
(30M)

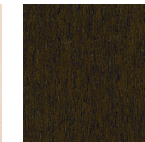

Espresso  
(23M)



Transparent  
Black  
(29M)

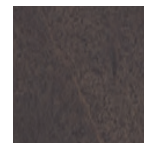

Graphite  
(25M)

Quick Links /

**View Side Chair**

**View Counter Stool**

**View Bar Stool**

**View Low Stool**

**For SCS certified wood finishes, please refer to the following document: [SCS Certified Wood Finishes](#)**

Due to limitations of the color printing process these finish samples should be considered representative only. For larger finish samples, please contact Leland Customer Experience at (800) 859-7510.

# Omena

Wood Finish Options

LELAND



## SEMI-TRANSPARENT & OPAQUE



Oxford II  
(49M)  
100% Opaque



Dolphin II  
(50M)  
100% Opaque

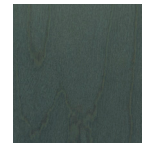

Blue Sky  
(100M)



Forest  
(101M)



Gravel  
(102M)

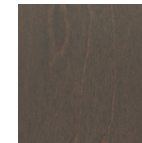

Heather  
(103M)



Dawn  
(104M)

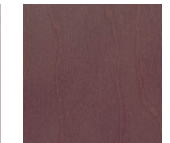

Grape  
(105M)



Sienna  
(106M)



Lake Breeze  
(107M)

Quick Links /

[View Side Chair](#)

[View Counter Stool](#)

[View Bar Stool](#)

[View Low Stool](#)

For SCS certified wood finishes, please refer to the following document: [SCS Certified Wood Finishes](#)

Due to limitations of the color printing process these finish samples should be considered representative only. For larger finish samples, please contact Leland Customer Experience at (800) 859-7510.

# Omena

Premium Oak

LELAND



Morel  
(66M)



Weathered  
(68M)



Dune  
(69M)



Trillium  
(70M)



Quick Links /

[View Side Chair](#)

[View Counter Stool](#)

[View Bar Stool](#)

[View Low Stool](#)

**For SCS certified wood finishes, please refer to the following document: [SCS Certified Wood Finishes](#)**

Due to limitations of the color printing process these finish samples should be considered representative only. For larger finish samples, please contact Leland Customer Experience at (800) 859-7510.



# Omena

(Foot Ring) Powder Coat

LELAND

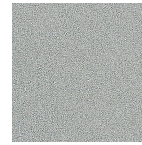

Sterling  
(ST)



Mercury Textured  
(MRT)



Mineral Textured  
(MNT)



Burnish Textured  
(BNT)



Foundry Textured  
(FNT)



Dolphin Textured  
(DLT)



Oxford Textured  
(OXT)

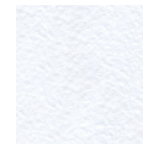

White Textured  
(WT)

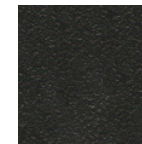

Black Textured  
(BT)

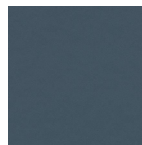

Matte Blue Sky  
(MBS)

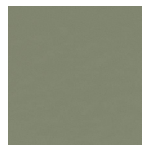

Matte Forest  
(MFO)



Matte Sienna  
(MSN)



Matte Willow  
(MWL)



Chrome  
(C)

- Quick Links /  
[View Side Chair](#)  
[View Counter Stool](#)  
[View Bar Stool](#)  
[View Low Stool](#)

Due to limitations of the color printing process these finish samples should be considered representative only. For larger finish samples, please contact Leland Customer Experience at (800) 859-7510.

# Omena

Gradient Finishes

LELAND

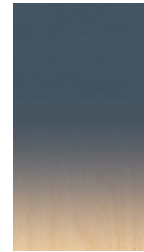

Blue Sky BG  
(90MG)



Gravel GG  
(87MG)

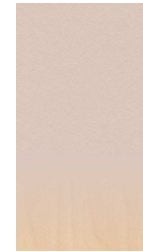

Dawn DG  
(88MG)



Forest FG  
(86MG)



Heather HG  
(99MG)

Gradient finishes applied on maple shell/leg only.  
Offered only on Omena side chair and low stool..

Quick Links /

[View Side Chair](#)

[View Counter Stool](#)

[View Bar Stool](#)

[View Low Stool](#)

Due to limitations of the color printing process these finish samples should be considered representative only. For larger finish samples, please contact Leland Customer Experience at (800) 859-7510.

---

# LELAND

**5695 Eagle Drive, SE**  
**Grand Rapids,**  
**Michigan 49512**  
**616-975-9260**  
**[lelandfurniture.com](http://lelandfurniture.com)**