

LELAND

Price List

January 2025



Pricing Effective: January 2025

January 2023 Pricelist

Terms & Conditions: Table of Contents	2
Ordering Information	4
Terms, Conditions & General Information	6
Freight Program	9

Amadeus Pricelist	AM
Baraga Pricelist	BA
Brit Bench Pricelist	BBM
Cambre Table Pricelist	CA
Café Parfait Pricelist	CP
Ease Pricelist	ES
Ebb Fully Upholstered Bench Pricelist	EB
Fast Table Pricelist	FT
Fixed Table Pricelist	FXT
Fly Table Pricelist	FLY
Hammok Pricelist	HS
Handy Stool Pricelist	HA
Leah Table Pricelist	LT
M2 Seating Pricelist	M2S
M3 Table Pricelist	M3T
Marquette Pricelist	MQ
Mass Chair Pricelist	MA
Omena Pricelist	OM

Parfait II Pricelist	P11
Pluto Bench Pricelist	PB
Quarry Pricelist	QR
Rapson Forty-Eight Chair Pricelist	RP48-C
Rapson Thirty-Nine Bench Pricelist	RP39-B
Rapson Thirty-Nine Guest Pricelist	RP39-G
Rapson Thirty-Nine Lounge Pricelist	RP39-L
Slam Pricelist	SL
Slam Beam Pricelist	SB
Valeri Pricelist	VS

Orders

All orders must be submitted in writing either by fax or e-mail. Specify each item by its product code and the corresponding model description, finish, upholstery and options offered in the price list. If the customer's current product order must match a previous order, Leland International must be notified. A sample product from the original order must be submitted at the expense of the customer to assure uniformity of finish and construction. Orders with missing or incorrect information such as model, finish, color, pricing, etc. will be scheduled upon receipt of correct and complete information.

Leland products are specified for and installed in a variety of end user applications. It is the responsibility of the purchasing party to understand the end user's intent and purchase products appropriate for that application. Leland takes no responsibility for incorrect specifications. Acceptance and fulfillment of any purchase order does not imply that the product is suitable for a certain application. Leland will only warranty products that have been installed in applications for which they were designed.

If multiple delivery schedules are required, the customer must submit separate purchase orders for each delivery date.

Acknowledgement

Orders are only accepted by issuance of our formal acknowledgment. It is the purchaser's responsibility to check acknowledgements and invoices for accuracy. If there is any discrepancy, the customer must notify Leland International within 72 hours. Failure to notify Leland International within this time period will constitute acceptance of the order as acknowledged, and our acknowledgment is final and binding.

All acknowledgments will contain an estimated ship date. If for some reason the furniture must not ship earlier than the estimated ship date, please specify a "Do not ship before date" in your purchase order. We are not responsible for delays in scheduling or failure to make scheduled ship date due to strikes, lockouts or other labor complications, war, riots, Acts of God, fires, accidents, restraints affecting shipment or credit, reduced supply or excessive cost of fuel or raw material, delays from suppliers, compliance with government regulations or other unforeseen contingencies.

Wood Finishes

Wood finishes can be light sensitive; therefore, care should

be taken to avoid placing chairs in areas exposed to intense natural light. Due to variations common to all wood species,

the color and grain characteristics of the finish samples may not exactly match that of the finished product. Custom finishes must meet factory approval and are subject to a \$100.00 minimum net mixing charge. Please allow up to three weeks to prepare the custom wood finish match sample. Orders will not be scheduled or acknowledged until finish match approval is received in writing.

Due to limitations of the raw materials and the natural background color of wood, not all colors can be successfully reproduced. The suitability of a color for custom finish matching cannot always be determined beforehand. This is especially true in the case of custom colors submitted on non-wood products. If we are unable to produce a commercial match to your custom color, you will be notified at the earliest possible date, and no charge will be levied.

Laminates

The following laminates with the manufacturers noted are considered to be standard and are usually in stock.

FORMICA®

www.formica.com/en/us/trade-products or call 800.367.6422

Select solid colors, wood grains or patterns
 Select number/name
 Select standard finishes
 Laminates with -58 (matte finish) are standard

WILSONART®

www.wilsonartcontract.com/pattern-availability/
 or call 800.433.3222

Select laminate finish,
 Select Leland standard finish -38 (fine velvet texture)
 or -60 (matte)

PIONITE®

www.pionite.com/pionite/pages_pionite/pionite_colors.html
 or call 800.746.6483

Select colors

Customer's Own Information (COM)

Leland International reserves the right of preliminary approval of all COM, prior to order acceptance. Even after such preliminary approval, Leland International reserves the right to reject COM if, upon physical inspection of the COM, it proves unacceptable for use on Leland International products. When this occurs, the customer will be notified in writing with an explanation of the problem. A written release from the customer will be required for the order to be processed.

It is recommended that all COM textile be tested for compatibility with Leland's products prior to sending COM to Leland for application. Please contact Customer Experience to request the COM Approval Form with instructions for COM submittal.

Choosing not to have COM textile tested for compatibility may result in the COM being rejected at the expense of the customer.

Leland International cannot assume responsibility for durability, appearance or other qualities of customer's own material on the finished product and does not give any warranty with respect to COM. At Leland International's discretion,

additional yardage, labor charges, or handling surcharges may be required as a condition of COM acceptance. COM delivered to Leland International without proper identification may be refused, and Leland International shall have no responsibility for loss or any other claims. Excess textile will not be returned unless specifically requested in writing.

Please contact the Leland Customer Experience Department for yardage requirements on all COM textiles which are patterned or narrower than 54 inches wide.

Orders using COM may be rescheduled if the COM has not been received two (2) weeks prior to the original ship date. Every effort will be made to avoid a delay and to complete the customer's order within the standard lead time.

All shipments of COM to Leland International must be sent prepaid. COM should be sent to:

LELAND INTERNATIONAL
5695 Eagle Drive SE
Grand Rapids, Michigan 49512

COM packages must include the following information:

- Name of customer

- Purchase order number to which the material is to be applied and Leland Sales Order, if known.

Purchase orders specifying COM must include the following:

- Indicate which side of the textile is to be exposed (manufacturer's implied face will be used if no side is indicated by the customer).
- If textile is a stripe or pattern, specify vertical or horizontal upholstered application (textile will be applied off the bolt if no direction is indicated by the customer).
- COM suppliers' name, textile number and quantities of pieces to which the material is to be applied.

California Technical Bulletin 133 [TB 133]

TB 133 is a full scale fire performance test of complete articles of seating furniture. Some Leland International products in combination with a variety of upholstery textiles have been tested and are in compliance with TB 133. Test documentation is available upon request. If you wish to specify Leland products that have not been tested for compliance with TB 133 please consult Leland Customer Experience Department for TB 133 testing cost information.

In order for Leland products to comply with TB 133 the foam must be protected with a fire blocker or a special fire retardant foam must be used. For those products that must comply with TB 133 there will be a net charge per chair for fire blocker laminating or fire retardant foam. Please contact Leland International for a CAL 133 quotation on all seating.

Since TB 133 tests furniture and not components, there are no TB 133 approved textiles. Textiles comprised solely or in any combination of the following fibers are more likely to be suitable components for chairs that must comply with TB 133.

- | | | |
|----------------|--------------|-----------|
| Acrylic | Nylon | |
| Vinyl | Animal Hairs | Polyester |
| Wool | | Virgin |
| Cordura | Rayon | |
| Viscose | Cotton | |
| SEF Modacrylic | Wool | |
| Leather | Silk | |
| Worsted Wool | Modacrylic | |
| Spun Nylon | Mohair | |
| Trevira | | |

Prices

All prices are list prices F.O.B. our factory in Grand Rapids, Michigan 49512. Our pricing includes packing and corrugated cartoning for common carrier shipments. List prices do not include freight, storage, taxes or additional packaging required for certain carriers and are subject to change without notice.

We reserve the right to change quotation prices prior to acceptance by the buyer. Quotation prices must be accepted within 30 days unless otherwise specified in writing on the quotation. Pricing on orders specifying shipment 90 days or more after the formal date of acknowledgment will be based on pricing prevailing at time of shipment.

Resale Rights

Leland International reserves the right to reject any order placed by any customer for any reason, irrespective of whether orders have been previously accepted from such customer, without incurring liability to such customer. No customer shall have a continuing right to buy products from the company except pursuant to a formal dealer agreement or other written agreement covering future supply executed by the company and the reseller. Distribution of the price list or catalog does not itself constitute an offer to sell.

Credit and Payment Terms

An open account may be established for new customers. One bank and three trade references will be required and must be faxed to Leland International, attention:

Accounting. Credit will be established upon review and approval of your application.

Allow up to four weeks delay for credit approval. To avoid this delay, orders on new accounts must be accompanied by a 50% deposit. If credit is approved by the time the order is ready for shipment, the balance must be paid within terms. Accounts that are inactive for a twelve month period will automatically be closed and are subject to the above conditions for new accounts. Leland International may change or cancel credit at its discretion and may request advance payment at any time.

Upon establishment of an open account, terms are "Net 15 Days" after date of invoice with a credit limit established on a per customer basis. 1½% per month service charge will be added to all past due accounts. Orders will not be processed for past due accounts until the amount due, including any

service charge, is paid in full. All custom orders will require a down payment of 50% and will not be scheduled for production until the down payment is received.

Leland International reserves the right to revoke the terms of any customer at any time for any reason.

Orders for customers that have pre-paid terms require payment in full in (7) seven business days prior to the scheduled ship date. Payment not received by this day may result in the order being rescheduled.

Changes and Cancellations

Orders are not subject to change or cancellation without factory approval. Leland International will make every reasonable effort to stop production scheduling, shipment, etc., upon receipt of written notification of changes, cancellations or deferments stipulated as follows. Approved cancellations, changes, and delivery date extensions may be subject to charges.

Cancellations

Cancellations received prior to production will be assessed a \$100 net cancellation charge. Cancellations received after production has been started will be assessed the total accumulated cost of the project plus a \$100 net cancellation charge.

Deferred Shipments

If the order is complete or in the production cycle, charges will be assessed from the completion date in accordance with policy for "Storage by the Manufacturer."

Storage by the Manufacturer

If the customer cannot accept delivery when merchandise is ready, according to the terms of our acknowledgment, we reserve the right to transfer goods to storage at the customer's expense, and the order will be invoiced at the time of storage. Payment of this invoice will be due on the original terms given to the customer. Storage charges and freight charges for delivery will be invoiced separately upon release of the merchandise from storage and will be due upon receipt of the invoice. Orders put into storage require payment in full and all incurred storage charges must be paid prior to the order being shipped.

Shipping

We will ship in accordance with the customer's written instructions. If customer omits specific shipping instructions, we will ship in the manner that we consider to be the best way. All shipments are sent F.O.B. Grand Rapids, Michigan 49512. Leland International's liability ends when received by the carrier at Leland International's dock. Title of the goods and risk of loss transfers to the buyer at that time. Freight shall be paid by the buyer unless otherwise acknowledged in writing by Leland International. We make every effort to ship orders complete and on schedule. We reserve the right to make partial shipments as merchandise is ready. Failure to deliver all the merchandise at one time does not relieve the customer of the obligation to accept and pay for merchandise received.

Damage Claims

All Leland International products are thoroughly inspected prior to shipment from our factory and packed to comply with carrier requirements. Customers must carefully inspect all items upon arrival and note any damage on the delivery receipt. Phrasing such as "Subject to Inspection" does not constitute a note of damage and will not be accepted as grounds for honoring a freight claim. A written claim must be filed within 15 days of receipt with the carrier if any obvious or subsequent

concealed damage is discovered and still does not guarantee the honoring of freight claim. Caution: When a clear receipt is obtained by a carrier, Leland International, nor the carrier, are any longer responsible for damages or shortages. Processing claims for damage and shortages are the responsibility of the buyer unless otherwise specified in writing by Leland International. At no time can claims be deducted from our invoices.

Delivery Charges

Charges incurred by Leland International complying with any non-standard shipment request such as inside delivery, expediting, redelivery, weekend delivery, unpacking, straight trucks, specific driver requests, or temporary holding will be invoiced to the purchaser.

Storage by Owner

Due to the inherent nature of wood products, we cannot guarantee any product stored or set in place in an environment where temperature and humidity are not controlled. Temperatures must be maintained within a range of 50°-80° F (10°-27° C); the relative humidity must be maintained between 25% and 40%. These conditions are also recommended for human health standards.

Product Discrepancy

Errors in products including color, size, other variations, or missing components must be reported to Leland International within thirty (30) days of delivery. Failure by the purchaser to report any product inaccuracies within thirty (30) days of delivery shall constitute acceptance of the product.

Miscellaneous

All costs for furniture installation, removal from service and reinstallation due to damage claims, partial shipments, shipping errors or warranty claims is the responsibility of the customer. Leland International will not be liable for costs associated with any of the above conditions.

Sizes and weights are considered to be approximate. Leland International reserves the right to make changes in design and construction or discontinue products without notice. Due to conditions beyond our control all wood products, textiles and vinyls are subject to variations in color, texture and grain.

Price list specifications supersede all other specifications whether verbal or written, and may not be altered without the written consent of an officer of Leland International. All clerical errors on any agreement, publication, correspondence, price list, or product literature pieces are subject to correction at any time.

MAINTENANCE

Since chairs and tables are installed and used under a variety of conditions, users must make inspections no less than every six months to look for damage or signs of structural fatigue incurred in daily handling, use and abuse. Examinations must include welds, machine screw assemblies and the shell to base fasteners. If problems are discovered that could compromise the structural safety of a chair, it should be immediately removed from service and Leland International should be notified. Coats and other articles should not be hung on the back of chairs. This practice may cause chairs to be unstable. Chairs are not designed to be placed seat down on table surfaces. Chairs stored in this manner are unstable. The shock of chairs falling from table tops may compromise the structural integrity of the shell/base attachment.

Warranty

All merchandise is manufactured in accordance with our high industrial and design standards and is warranted to be free from defects of material and workmanship for a period of (5) five years from the date of delivery or placement in storage. This warranty covers goods under normal use and is in service under conditions for which the merchandise is designed. Leland International considers normal use to be (5) five days per week (8) eight hours per day. Extended use (multiple shifts, 24 hour facilities, etc) will reduce this warranty to (2) two years. We offer no warranty on chair upholstery materials, plastic laminate table surfaces and operating components other than those expressed by the manufacturer of those components.

Our obligation during this warranty period is limited to repair or replacement at our option. This warranty becomes null and void on any goods repaired or altered by any person not so authorized by Leland International or any merchandise which has been subject to misuse, improper storage, including placing chairs seat down on tables, negligence, or accident. We make no other warranties either expressed or implied as to any matter whatsoever, including without limitation, the condition of the merchandise, its merchantability, or its fitness for any particular user or purpose.

All claims will be processed by the Customer Experience Department. All returns must be authorized in writing. Merchandise authorized for return and subsequent repair or replacement merchandise shall be removed from service. All shipping, packaging, and installation charges shall be at the expense of the customer. Since furniture is installed and used under a variety of conditions, users are required to make inspections every six months to look for damage or

signs of structural fatigue incurred in daily handling, use, or abuse. Inspections must include, but are not limited to, the tightening of bolts and fasteners, and the lubrication of mechanisms. Failure to properly maintain Leland products will void this warranty.

Leland International will not be liable for loss of time, inconvenience, commercial loss, or incidental or consequential damages that may result from a warranty claim.

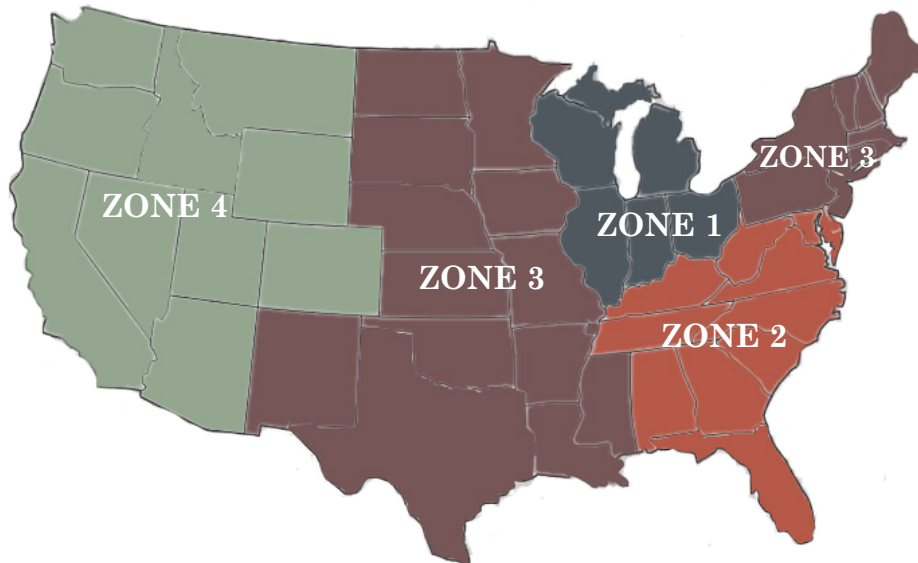

Zone 1 (4%)	Zone 2 (5%)	Zone 3 (6%)	Zone 3 (6%) CONT.	Zone 4 (7%)
Indiana	Alabama	Arkansas	New Hampshire	Arizona
Illinois	Delaware	Connecticut	New Jersey	California
Michigan	Florida	Iowa	New Mexico	Colorado
Ohio	Georgia	Kansas	New York	Idaho
Wisconsin	Kentucky	Louisiana	North Dakota	Montana
	Maryland	Maine	Oklahoma	Nevada
	North Carolina	Massachusetts	Pennsylvania	Oregon
	South Carolina	Minnesota	Rhode Island	Utah
	Tennessee	Mississippi	South Dakota	Washington
	Virginia	Missouri	Texas	Wyoming
	Washington DC	Nebraska	Vermont	
	West Virginia			

Overview

Leland Furniture's Freight Program is offered to all customers for convenient and competitive freight prices in the continental United States.

How It Works

1. Determine the LIST value of your order.
2. Determine the zone to which the freight will be shipping (Zones 1-4)
3. Calculate your freight charges by multiplying the list price and applicable zone charges (e.g.: \$10,000 LIST order shipping to Arizona is \$10,000 x 0.07 = \$700 NET freight).
4. Verify that your calculated charges meet or exceed minimums.
5. Note on your PO "Freight determined by Leland Freight Program".

Zone Percentages and Minimums

Zone 1	4%	Minimum \$350
Zone 2	5%	Minimum \$350
Zone 3	6%	Minimum \$350
Zone 4	7%	Minimum \$350

Remember

Freight percentages are based on LIST price of order.

Leland Furniture Freight Program is based on dockside delivery only. Residential Delivery, Inside Delivery, etc. will incur additional charges; please contact Leland Customer Service for current prices.

Freight is FOB Grand Rapids, MI 49512; the receiving company is responsible for noting any damage at the time of delivery on the Delivery Receipt. Leland Furniture assumes no responsibility for freight damage, either noted on delivery receipt or concealed.

As fuel prices fluctuate, Leland Furniture reserves the right to add necessary fuel surcharges.

Leland Furniture reserves the right to change or discontinue the Freight Program at any time.

Amadeus

January 2025 Price List



Amadeus

Table of Contents	AM2
Specification Information	AM3
Specification Example	AM4
Stacking/ganging sled base	AM5
Stacking Chair Tapered Four Leg Base	AM7
Arm Chair, Tapered Four Leg Base	AM9
Side Chair, Wood Base	AM11
Counter Chair, Sled base	AM13
Counter Chair, Wood Base	AM15
Bar Chair, Sled base	AM17
Bar Chair, Wood Base	AM19

Chair Model

DESCRIPTION	CODE
AMADEUS stacking/ganging sled base	AMS
AMADEUS stacking chair, tapered four leg base	AM4
AMADEUS arm chair, tapered four leg base	AMA
AMADEUS side chair, wood base	AMSW
AMADEUS counter chair	AMCS
AMADEUS counter chair, wood base	AMCW
AMADEUS bar chair	AMBS
AMADEUS bar chair, wood base	AMBW

Shell Selection

DESCRIPTION	CODE
Polypropylene	PO
Polypropylene with Upholstered Seat Onlay	PU
Fully Upholstered	FU
3D Beech Veneer	3DB
3D Beech Veneer with Upholstered Seat Onlay	3BU
3D American Walnut Veneer	3DW
3D American Walnut Veneer with Upholstered Seat Onlay	3WU

Shell Finish/Color

POLYPROPYLENE SHELL:

DESCRIPTION	CODE	DESCRIPTION	CODE
White	WT	Oxford	OX
Black	BK	Dolphin	DL
Fawn	FW	Seafoam	SF
Fog	FG	Habanero	HB
Blue Sky	BS	Dijon	DJ
Ink	IN		

CUSTOM POLYPROPYLENE COLORS

Custom color match is available upon request.
Please contact hello@lelandfurniture.com for further information

BEECH 3D VENEER SHELL:

DESCRIPTION	CODE
Natural Beech	09

STANDARD LELAND COLORS

AMERICAN WALNUT 3D VENEER SHELL:

DESCRIPTION	CODE
Natural Walnut Matte	08M

Fully Upholstered or Onlay Selection

Please refer to Leland Textile Program which features textiles and leathers from the following partners:

- Camira
- Carnegie
- CF Stinson
- Green Hides
- Maharam
- Unika Vaev

The complete grade list can be found on our website or you can specify COM/COL. Due to the design of this product, it is recommended that all non pre-approved textile be tested for compatibility.

Frame Finishes

SLED BASE & TAPERED FOUR LEG BASE:

DESCRIPTION	CODE
Sterling	ST
Warm Grey	WG
Cool Grey	CG
Black	B
White	W
Habanero	HBN
Matte Seafoam	MSF
Matte Dijon	MDJ
Matte Mercury	MMR
Matte Mineral	MMN
Matte Burnish	MBN
Matte Foundry	MFN
Chrome	C

TEXTURED

DESCRIPTION	CODE
White Textured Powder coat	WT
Black Textured Powder coat	BT
Dolphin Textured Powder coat	DLT
Ink Textured Powder Coat	INT

Glide or Caster Type

STANDARD GLIDES:

DESCRIPTION	CODE
Poly (Sled base)	S
Nylon (Tapered Four leg Base) & Wood Base	S

OPTIONAL GLIDES:

DESCRIPTION	CODE
Felt	FC

*Please note that optional glides for four leg models raise the chair height .5 inch.

Stacking note

Amadeus side chair, armless models stack as follows: (including upholstered)

SLED BASE:

ARMLESS:
Floor: 15 High
Dolly: 20 High

TAPERED FOUR LEG BASE:

ARMLESS:
Floor: 10 High
Dolly: 12 High

Specifications required to create the product code

- Model
- Shell Selection
- Shell Finish/Color
- Upholstered Onlay Selection (when applicable)
- Frame Finish (or foot ring where applicable)
- Glide Type

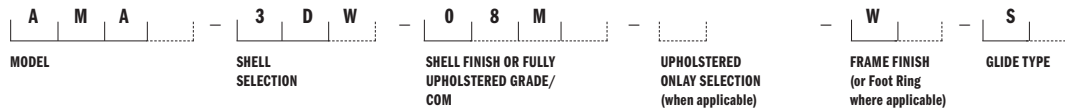

MODEL

Amadeus arm chair, Tapered four leg base (AMA)

SHELL SELECTION

3D American Walnut Veneer (3DW)

SHELL FINISH/COLOR

Natural Walnut Matte (08M)

UPHOLSTERED ONLAY SELECTION

When applicable, enter upholstery grade, COM

FRAME FINISH (OR FOOT RING WHERE APPLICABLE)

White (W)

GLIDE TYPE

Standard Nylon (S)



AMADEUS STACKING/GANGING SLED BASE
 Design: Martin Ballendat

AM5



Amadeus Sled Base Chair	MODEL	FRAME FINISH	LIST PRICE
Polypropylene shell	AMS-PO	Powder Coat	\$412
W 21 D 21.75 H 31.75 SH 18		Chrome	\$477

Optional Glides: Add \$8.00 net per chair for a set of four (4).



Amadeus Sled Base Chair	MODEL	LIST PRICE/GRADE	COM/COL	A	B	C	D	E	F	G	H	I	J	K	L
Polypropylene shell, upholstered seat onlay	AMS-PU	Powder Coat	\$554	598	619	640	661	682	703	724	745	766	787	808	829
		Chrome	\$618	662	683	704	725	746	767	788	809	830	851	872	893

W 21 D 21.75 H 32 SH 19

COM Yardage: 1 or 2 seats: .75 yard

Contact Leland Customer Experience for yardage requirements on textiles with repeats.

Optional Glides: Add \$8.00 net per chair for a set of four (4).



Amadeus Sled Base Chair	MODEL	LIST PRICE/GRADE	COM/COL	A	B	C	D	E	F	G	H	I	J	K	L
Fully upholstered	AMS-FU	Powder Coat	\$747	843	892	941	990	1039	1088	1137	1186	1235	1284	1333	1382
		Chrome	\$817	915	964	1013	1062	1111	1160	1209	1258	1307	1356	1405	1454

W 21 D 21.75 H 32 SH 18

COM Yardage: 1 seat: 1.5 yards

Contact Leland Customer Experience for yardage requirements on textiles with repeats.

Optional Glides: Add \$8.00 net per chair for a set of four (4).

To specify:
 Please refer to pages 3-4 for complete specifying information.
 Specify all products by their product code.

AMADEUS STACKING/GANGING SLED BASE
Design: Martin Ballendat

AM6



Amadeus Sled Base Chair	MODEL	FRAME FINISH	LIST PRICE
3D Beech veneer shell	AMS-3DB	Powder Coat	\$794
W 21 D 21.75 H 31.75 SH 18		Chrome	\$864

Optional Glides: Add \$8.00 net per chair for a set of four (4).



Amadeus Sled Base Chair	MODEL	LIST PRICE/GRADE	COM/COL	A	B	C	D	E	F	G	H	I	J	K	L
3D Beech veneer shell, upholstered seat onlay	AMS-3BU	Powder Coat	\$946	993	1016	1039	1062	1085	1108	1131	1154	1177	1200	1223	1246
		Chrome	\$1015	1063	1086	1109	1132	1155	1178	1201	1224	1247	1270	1293	1316

W 21 D 21.75 H 32 SH 19

COM Yardage: 1 or 2 seats: .75 yard

Contact Leland Customer Experience for yardage requirements on textiles with repeats.

Optional Glides: Add \$8.00 net per chair for a set of four (4).



Amadeus Sled Base Chair	MODEL	FRAME FINISH	LIST PRICE
3D Walnut veneer shell	AMS-3DW	Powder Coat	\$1147
W 21 D 21.75 H 31.75 SH 18		Chrome	\$1215

Optional Glides: Add \$8.00 net per chair for a set of four (4).



Amadeus Sled Base Chair	MODEL	LIST PRICE/GRADE	COM/COL	A	B	C	D	E	F	G	H	I	J	K	L
3D Walnut veneer shell, upholstered seat onlay	AMS-3WU	Powder Coat	\$1300	1346	1372	1398	1424	1450	1476	1502	1528	1554	1580	1606	1632
		Chrome	\$1368	1414	1439	1464	1489	1514	1539	1564	1589	1614	1639	1664	1689

W 21 D 21.75 H 32 SH 19

COM Yardage: 1 or 2 seats: .75 yard

Contact Leland Customer Experience for yardage requirements on textiles with repeats.

Optional Glides: Add \$8.00 net per chair for a set of four (4).

To specify:
Please refer to pages 3-4 for complete specifying information.
Specify all products by their product code.



Amadeus

Tapered Four Leg Base Chair

	MODEL	FRAME FINISH	LIST PRICE
Polypropylene shell	AM4-PO	Powder Coat	\$489
W 21 D 22 H 32 SH 18		Chrome	\$557

Optional Glides: Add \$8.00 net per chair for a set of four (4).



Amadeus

Tapered Four Leg Base Chair

	MODEL	LIST PRICE/GRADE	COM/COL	A	B	C	D	E	F	G	H	I	J	K	L
Polypropylene shell,	AM4-PU	Powder Coat	\$636	682	703	724	745	766	787	808	829	850	871	892	913
upholstered seat only		Chrome	\$702	747	769	791	813	835	857	879	901	923	945	967	989
W 21.5 D 22 H 32 SH 19		COM Yardage: 1 or 2 seats: .75 yard													

Contact Leland Customer Experience for yardage requirements on textiles with repeats.
Optional Glides: Add \$8.00 net per chair for a set of four (4).



Amadeus

Tapered Four Leg Base Chair

	MODEL	LIST PRICE/GRADE	COM/COL	A	B	C	D	E	F	G	H	I	J	K	L
Fully upholstered	AM4-FU	Powder Coat	\$840	940	992	1044	1096	1148	1200	1252	1304	1356	1408	1460	1512
W 21.5 D 22 H 32 SH 18		Chrome	\$915	1018	1069	1120	1171	1222	1273	1324	1375	1426	1477	1528	1579
		COM Yardage: 1 seat: 1.5 yards													

Contact Leland Customer Experience for yardage requirements on textiles with repeats.
Optional Glides: Add \$8.00 net per chair for a set of four (4).

To specify:

Please refer to pages 3-4 for complete specifying information. Specify all products by their product code.



Amadeus

Tapered Four Leg Base Chair

	MODEL	FRAME FINISH	LIST PRICE
3D Beech veneer shell	AM4-3DB	Powder Coat	\$890
W 21 D 21.75 H 31.75 SH 18		Chrome	\$960

Optional Glides: Add \$8.00 net per chair for a set of four (4).



Amadeus

Tapered Four Leg Base Chair

	MODEL	LIST PRICE/GRADE	COM/COL	A	B	C	D	E	F	G	H	I	J	K	L
3D Beech veneer shell, upholstered seat onlay	AM4-3BU	Powder Coat	\$1044	1093	1116	1139	1162	1185	1208	1231	1254	1277	1300	1323	1346
		Chrome	\$1115	1162	1188	1214	1240	1266	1292	1318	1344	1370	1396	1422	1448

W 21 D 21.75 H 32 SH 19

COM Yardage: 1 or 2 seats: .75 yard

Contact Leland Customer Experience for yardage requirements on textiles with repeats.

Optional Glides: Add \$8.00 net per chair for a set of four (4).



Amadeus

Tapered Four Leg Base Chair

	MODEL	FRAME FINISH	LIST PRICE
3D Walnut veneer shell	AM4-3DW	Powder Coat	\$1252
W 21 D 21.75 H 31.75 SH 18		Chrome	\$1327

Optional Glides: Add \$8.00 net per chair for a set of four (4).



Amadeus

Tapered Four Leg Base Chair

	MODEL	LIST PRICE/GRADE	COM/COL	A	B	C	D	E	F	G	H	I	J	K	L
3D Walnut veneer shell, upholstered seat onlay	AM4-3WU	Powder Coat	\$1409	1457	1482	1507	1532	1557	1582	1607	1632	1657	1682	1707	1732
		Chrome	\$1482	1531	1553	1575	1597	1619	1641	1663	1685	1707	1729	1751	1773

W 21 D 21.75 H 32 SH 19

COM Yardage: 1 or 2 seats: .75 yard

Contact Leland Customer Experience for yardage requirements on textiles with repeats.

Optional Glides: Add \$8.00 net per chair for a set of four (4).

To specify:

Please refer to pages 3-4 for complete specifying information. Specify all products by their product code.

AMADEUS ARM CHAIR, TAPERED FOUR LEG BASE
Design: Martin Ballendat

AM9



Amadeus Arm Chair
Tapered Four Leg Base Chair

	MODEL	FRAME FINISH	LIST PRICE
Polypropylene shell	AMA-PO	Powder Coat	\$610
W 23.5 D 21.75 H 32		Chrome	\$725
SH 18 AH 26	Optional Glides: Add \$8.00 net per chair for a set of four (4).		



Amadeus Arm Chair
Tapered Four Leg Base Chair

	MODEL	LIST PRICE/GRADE	COM/COL	A	B	C	D	E	F	G	H	I	J	K	L
Polypropylene shell, upholstered seat onlay	AMA-PU	Powder Coat	\$777	829	855	881	907	933	959	985	1011	1037	1063	1089	1115
W 23.75 D 22 H 32		Chrome	\$870	922	948	974	1000	1026	1052	1078	1104	1130	1156	1182	1208
SH 19 AH 26	COM Yardage: 1 or 2 seats: .75 yard														
	Contact Leland Customer Experience for yardage requirements on textiles with repeats.														
	Optional Glides: Add \$8.00 net per chair for a set of four (4).														



Amadeus Arm Chair
Tapered Four Leg Base Chair

	MODEL	LIST PRICE/GRADE	COM/COL	A	B	C	D	E	F	G	H	I	J	K	L
Fully upholstered	AMA-FU	Powder Coat	\$1010	1125	1183	1241	1299	1357	1415	1473	1531	1589	1647	1705	1763
W 23.5 D 21.75 H 32		Chrome	\$1114	1228	1287	1346	1405	1464	1523	1582	1641	1700	1759	1818	1877
SH 18 AH 26	COM Yardage: 1 seat: 1.5 yards														
	Contact Leland Customer Experience for yardage requirements on textiles with repeats.														
	Optional Glides: Add \$8.00 net per chair for a set of four (4).														

To specify:
Please refer to pages 3-4 for complete specifying information.
Specify all products by their product code.

AMADEUS ARM CHAIR, TAPERED FOUR LEG BASE
Design: Martin Ballendat

AM10



Amadeus Arm Chair
Tapered Four Leg Base Chair

	MODEL	FRAME FINISH	LIST PRICE
3D Beech veneer shell W 23.75 D 22 H 32 SH 19 AH 26	AMA-3DB	Powder Coat	\$1105
		Chrome	\$1227

Optional Glides: Add \$8.00 net per chair for a set of four (4).



Amadeus Arm Chair
Tapered Four Leg Base Chair

	MODEL	LIST PRICE/GRADE	COM/COL	A	B	C	D	E	F	G	H	I	J	K	L
3D Beech veneer shell, upholstered seat onlay W 23.75 D 22 H 32 SH 19 AH 26	AMA-3BU	Powder Coat	\$1282	1337	1363	1389	1415	1441	1467	1493	1519	1545	1571	1597	1623
		Chrome	\$1367	1424	1452	1480	1508	1536	1564	1592	1620	1648	1676	1704	1732

COM Yardage: 1 or 2 seats: .75 yard

Contact Leland Customer Experience for yardage requirements on textiles with repeats.

Optional Glides: Add \$8.00 net per chair for a set of four (4).



Amadeus Arm Chair
Tapered Four Leg Base Chair

	MODEL	FRAME FINISH	LIST PRICE
3D Walnut veneer shell W 23.5 D 21.75 H 32 SH 18 AH 26	AMA-3DW	Powder Coat	\$1561
		Chrome	\$1685

Optional Glides: Add \$8.00 net per chair for a set of four (4).



Amadeus Arm Chair
Tapered Four Leg Base Chair

	MODEL	LIST PRICE/GRADE	COM/COL	A	B	C	D	E	F	G	H	I	J	K	L
3D Walnut veneer shell, upholstered seat onlay W 23.5 D 22 H 32 SH 18 AH 26	AMA-3WU	Powder Coat	\$1741	1795	1824	1853	1882	1911	1940	1969	1998	2027	2056	2085	2114
		Chrome	\$1858	1915	1940	1965	1990	2015	2040	2065	2090	2115	2140	2165	2190

COM Yardage: 1 or 2 seats: .75 yard

Contact Leland Customer Experience for yardage requirements on textiles with repeats.

Optional Glides: Add \$8.00 net per chair for a set of four (4).

To specify:

Please refer to pages 3-4 for complete specifying information. Specify all products by their product code.

Pricing Effective: January 2025

AMADEUS SIDE CHAIR, POLY SHELL, WOOD BASE
 Design: Martin Ballendat

AM11

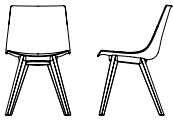

Amadeus Side Chair
Wood Base

	MODEL	FRAME FINISH	LIST PRICE
Polypropylene shell	AMSW-PO		\$893
W 19 D 22 H 32 SH 18		Optional Glides: Add \$8.00 net per chair for a set of four (4).	

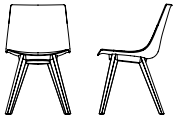

Amadeus Side Chair
Wood Base

	MODEL	LIST PRICE/GRADE	COM/COL	A	B	C	D	E	F	G	H	I	J	K	L
Polypropylene shell, upholstered seat only	AMSW-PU		\$1038	1082	1106	1130	1154	1178	1202	1226	1250	1274	1298	1322	1346
W 19 D 22 H 32 SH 19		COM Yardage: 1 or 2 seats: .75 yard													
		Contact Leland Customer Experience for yardage requirements on textiles with repeats.													
		Optional Glides: Add \$8.00 net per chair for a set of four (4).													

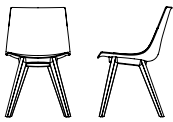

Amadeus Side Chair
Wood Base

	MODEL	LIST PRICE/GRADE	COM/COL	A	B	C	D	E	F	G	H	I	J	K	L
Fully upholstered	AMSW-FU		\$1295	1397	1448	1499	1550	1601	1652	1703	1754	1805	1856	1907	1958
W 19 D 22 H 32.5 SH 18		COM Yardage: 1 seat: 1.5 yards													
		Contact Leland Customer Experience for yardage requirements on textiles with repeats.													
		Optional Glides: Add \$8.00 net per chair for a set of four (4).													

To specify:
 Please refer to pages 3-4 for complete specifying information.
 Specify all products by their product code.

Pricing Effective: January 2025

AMADEUS SIDE CHAIR, WOOD BASE
Design: Martin Ballendat

AM12

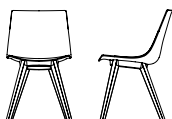

Amadeus Side Chair

Wood Base

	MODEL	FRAME FINISH	LIST PRICE
3D Beech veneer shell	AMSW-3DB		\$1786
W 19 D 22 H 32 SH 18		Optional Glides: Add \$8.00 net per chair for a set of four (4).	

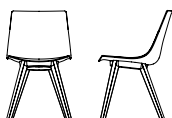

Amadeus Side Chair

Wood Base

	MODEL	LIST PRICE/GRADE	COM/COL	A	B	C	D	E	F	G	H	I	J	K	L
3D Beech veneer shell, upholstered seat onlay	AMSW-3BU		\$1943	1991	2013	2035	2057	2079	2101	2123	2145	2167	2189	2211	2233
W 19 D 22 H 32 SH 18		COM Yardage: 1 or 2 seats: .75 yard													
		Contact Leland Customer Experience for yardage requirements on textiles with repeats.													
		Optional Glides: Add \$8.00 net per chair for a set of four (4).													

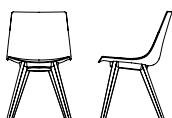

Amadeus Side Chair

Wood Base

	MODEL	FRAME FINISH	LIST PRICE
3D Walnut veneer shell	AMSW-3DW		\$2152
W 19 D 22 H 32 SH 18		Optional Glides: Add \$8.00 net per chair for a set of four (4).	

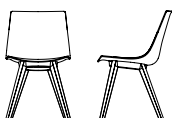

Amadeus Side Chair

Wood Base

	MODEL	LIST PRICE/GRADE	COM/COL	A	B	C	D	E	F	G	H	I	J	K	L
3D Walnut veneer shell, upholstered seat onlay	AMSW-3WU		\$2307	2355	2380	2405	2430	2455	2480	2505	2530	2555	2580	2605	2630
W 19 D 22 H 32 SH 18		COM Yardage: 1 or 2 seats: .75 yard													
		Contact Leland Customer Experience for yardage requirements on textiles with repeats.													
		Optional Glides: Add \$8.00 net per chair for a set of four (4).													

To specify:

Please refer to pages 3-4 for complete specifying information. Specify all products by their product code.

Pricing Effective: January 2025

AMADEUS COUNTER CHAIR, SLED BASE
Design: Martin Ballendat

AM13

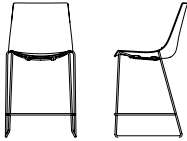

**Amadeus Counter Chair,
Sled Base**

	MODEL	FRAME FINISH	LIST PRICE
Polypropylene shell	AMCS-PO	Powder Coat	\$672
W 20.5 D 21.5 H 38.5 SH 26		Chrome	\$753

Optional Glides: Add \$8.00 net per chair for a set of four (4).

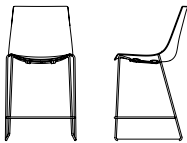

**Amadeus Counter Chair,
Sled Base**

	MODEL	LIST PRICE/GRADE	COM/COL	A	B	C	D	E	F	G	H	I	J	K	L
Polypropylene shell,	AMCS-PU	Powder Coat	\$818	863	886	909	932	955	978	1001	1024	1047	1070	1093	1116
upholstered seat onlay		Chrome	\$897	942	965	988	1011	1034	1057	1080	1103	1126	1149	1172	1195

W 20.5 D 21.5 H 38.5 SH 26

COM Yardage: 1 or 2 seats: .75 yard

Contact Leland Customer Experience for yardage requirements on textiles with repeats.

For COL requirements please contact Leland Customer Experience.

Optional Glides: Add \$8.00 net per chair for a set of four (4).

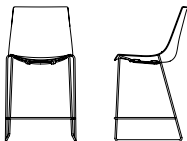

**Amadeus Counter Chair,
Sled Base**

	MODEL	LIST PRICE/GRADE	COM/COL	A	B	C	D	E	F	G	H	I	J	K	L
Fully upholstered	AMCS-FU	Powder Coat	\$1045	1148	1199	1250	1301	1352	1403	1454	1505	1556	1607	1658	1709
		Chrome	\$1136	1238	1288	1338	1388	1438	1488	1538	1588	1638	1688	1738	1788

W 20.5 D 21.5 H 38.5 SH 26

COM Yardage: 1 seat: 1.5 yards

Contact Leland Customer Experience for yardage requirements on textiles with repeats.

Optional Glides: Add \$8.00 net per chair for a set of four (4).

To specify:

Please refer to pages 3-4 for complete specifying information. Specify all products by their product code.

Pricing Effective: January 202

AMADEUS COUNTER CHAIR, SLED BASE
Design: Martin Ballendat

AM14

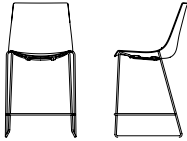

**Amadeus Counter Chair,
Sled Base**

	MODEL	FRAME FINISH	LIST PRICE
3D Beech veneer shell	AMCS-3DB	Powder Coat	\$1411
W 21 D 21.5 H 38.5 SH 26		Chrome	\$1498

Optional Glides: Add \$8.00 net per chair for a set of four (4).

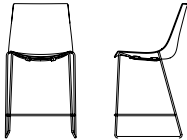

**Amadeus Counter Chair,
Sled Base**

	MODEL	LIST PRICE/GRADE	COM/COL	A	B	C	D	E	F	G	H	I	J	K	L
3D Beech veneer shell, upholstered seat onlay	AMCS-3BU	Powder Coat	\$1568	1616	1641	1666	1691	1716	1741	1766	1791	1816	1841	1866	1891
W 20.5 D 21.5 H 38.5 SH 26		Chrome	\$1653	1702	1725	1748	1771	1794	1817	1840	1863	1886	1909	1932	1955

COM Yardage: 1 or 2 seats: .75 yard
Contact Leland Customer Experience for yardage requirements on textiles with repeats.
Optional Glides: Add \$8.00 net per chair for a set of four (4).

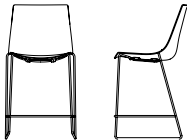

**Amadeus Counter Chair,
Sled Base**

	MODEL	FRAME FINISH	LIST PRICE
3D Walnut veneer shell	AMCS-3DW	Powder Coat	\$1602
W 20.5 D 21.5 H 38.5 SH 26		Chrome	\$1686

Optional Glides: Add \$8.00 net per chair for a set of four (4).

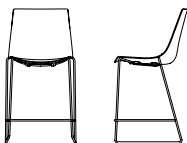

**Amadeus Counter Chair,
Sled Base**

	MODEL	LIST PRICE/GRADE	COM/COL	A	B	C	D	E	F	G	H	I	J	K	L
3D Walnut veneer shell, upholstered seat onlay	AMCS-3WU	Powder Coat	\$1757	1805	1829	1853	1877	1901	1925	1949	1973	1997	2021	2045	2069
W 20.5 D 21.5 H 38.5 SH 26		Chrome	\$1842	1890	1914	1938	1962	1986	2010	2034	2058	2082	2106	2130	2154

COM Yardage: 1 or 2 seats: .75 yard
Contact Leland Customer Experience for yardage requirements on textiles with repeats.
Optional Glides: Add \$8.00 net per chair for a set of four (4).

To specify:

Please refer to pages 3-4 for complete specifying information. Specify all products by their product code.

Pricing Effective: January 2025

AMADEUS COUNTER CHAIR, WOOD BASE
Design: Martin Ballendat

AM15

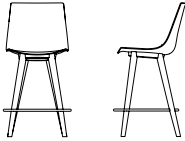

**Amadeus Counter Chair
Wood Base**

	MODEL	FRAME FINISH	LIST PRICE
Polypropylene shell	AMCW-PO		\$1291
W 20 D 22.5 H 40 SH 25.5		Optional Glides: Add \$8.00 net per chair for a set of four (4).	

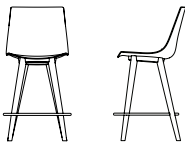

**Amadeus Counter Chair
Wood Base**

	MODEL	LIST PRICE/GRADE	COM/COL	A	B	C	D	E	F	G	H	I	J	K	L
Polypropylene shell, upholstered seat onlay	AMCW-PU		\$1435	1481	1504	1527	1550	1573	1596	1619	1642	1665	1688	1711	1734
W 20 D 22.5 H 40 SH 25.5		COM Yardage: 1 or 2 seats: .75 yard													
		Contact Leland Customer Experience for yardage requirements on textiles with repeats.													
		Optional Glides: Add \$8.00 net per chair for a set of four (4).													

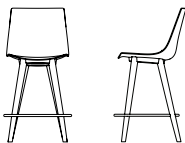

**Amadeus Counter Chair
Wood Base**

	MODEL	LIST PRICE/GRADE	COM/COL	A	B	C	D	E	F	G	H	I	J	K	L
Fully upholstered	AMCW-FU		\$1744	1847	1896	1945	1994	2043	2092	2141	2190	2239	2288	2337	2386
W 20 D 22.5 H 40 SH 25.5		COM Yardage: 1 seat: 1.5 yards													
		Contact Leland Customer Experience for yardage requirements on textiles with repeats.													
		Optional Glides: Add \$8.00 net per chair for a set of four (4).													

To specify:
Please refer to pages 3-4 for complete specifying information.
Specify all products by their product code.

Pricing Effective: January 2025

AMADEUS COUNTER CHAIR, WOOD BASE
Design: Martin Ballendat

AM16

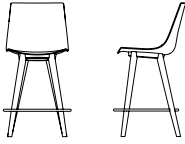

Amadeus Counter Chair

Wood Base				MODEL	FRAME FINISH	LIST PRICE
3D Beech veneer shell				AMCW-3DB		\$2215
W 20	D 22.5	H 40	SH 25.5	Optional Glides: Add \$8.00 net per chair for a set of four (4).		

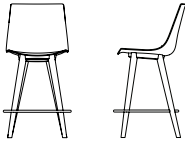

Amadeus Counter Chair

Wood Base				MODEL	LIST PRICE/GRADE	COM/COL	A	B	C	D	E	F	G	H	I	J	K	L
3D Beech veneer shell, upholstered seat onlay				AMCW-3BU	\$2369		2420	2444	2468	2492	2516	2540	2564	2588	2612	2636	2660	2684
W 20	D 22.5	H 40	SH 26	COM Yardage: 1 or 2 seats: .75 yard														
Contact Leland Customer Experience for yardage requirements on textiles with repeats.																		
Optional Glides: Add \$8.00 net per chair for a set of four (4).																		

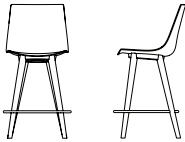

Amadeus Counter Chair

Wood Base				MODEL	FRAME FINISH	LIST PRICE
3D Walnut veneer shell				AMCW-3DW		\$2517
W 20	D 22.5	H 40	SH 25.5	Optional Glides: Add \$8.00 net per chair for a set of four (4).		

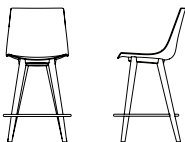

Amadeus Counter Chair

Wood Base				MODEL	LIST PRICE/GRADE	COM/COL	A	B	C	D	E	F	G	H	I	J	K	L
3D Walnut veneer shell, upholstered seat onlay				AMCW-3WU	\$2672		2720	2744	2768	2792	2816	2840	2864	2888	2912	2936	2960	2984
W 20	D 22.5	H 40	SH 26	COM Yardage: 1 or 2 seats: .75 yard														
Contact Leland Customer Experience for yardage requirements on textiles with repeats.																		
Optional Glides: Add \$8.00 net per chair for a set of four (4).																		

To specify:

Please refer to pages 3-4 for complete specifying information. Specify all products by their product code.

AMADEUS BAR CHAIR, SLED BASE
Design: Martin Ballendat

AM17

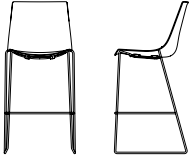

**Amadeus Bar Chair,
Sled Base**

	MODEL	FRAME FINISH	LIST PRICE
Polypropylene shell W 20.5 D 21.5 H 43.75 SH 29	AMBS-PO	Powder Coat	\$763
		Chrome	\$832

Optional Glides: Add \$8.00 net per chair for a set of four (4).

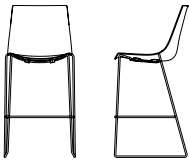

**Amadeus Bar Chair,
Sled Base**

	MODEL	LIST PRICE/GRADE	COM/COL	A	B	C	D	E	F	G	H	I	J	K	L
Polypropylene shell, upholstered seat onlay W 21 D 21.5 H 44 SH 30	AMBS-PU	Powder Coat	\$909	953	975	997	1019	1041	1063	1085	1107	1129	1151	1173	1195
		Chrome	\$977	1022	1045	1068	1091	1114	1137	1160	1183	1206	1229	1252	1275

COM Yardage: 1 or 2 seats: .75 yard

Contact Leland Customer Experience for yardage requirements on textiles with repeats.

For COL requirements please contact Leland Customer Experience.

Optional Glides: Add \$8.00 net per chair for a set of four (4).

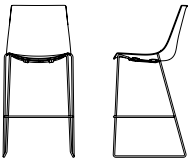

**Amadeus Bar Chair,
Sled Base**

	MODEL	LIST PRICE/GRADE	COM/COL	A	B	C	D	E	F	G	H	I	J	K	L
Fully upholstered W 20.5 D 21.5 H 43.75 SH 29	AMBS-FU	Powder Coat	\$1151	1252	1303	1354	1405	1456	1507	1558	1609	1660	1711	1762	1813
		Chrome	\$1228	1329	1381	1433	1485	1537	1589	1641	1693	1745	1797	1849	1901

COM Yardage: 1 seat: 1.5 yards

Contact Leland Customer Experience for yardage requirements on textiles with repeats.

Optional Glides: Add \$8.00 net per chair for a set of four (4).

To specify:

Please refer to pages 3-4 for complete specifying information. Specify all products by their product code.

Pricing Effective: January 2025

AMADEUS BAR CHAIR, SLED BASE
Design: Martin Ballendat

AM18

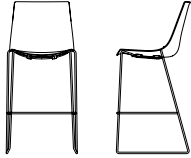

**Amadeus Bar Chair,
Sled Base**

	MODEL	FRAME FINISH	LIST PRICE
3D Beech veneer shell W 20.5 D 21.5 H 43.75 SH 29	AMBS-3DB	Powder Coat	\$1510
		Chrome	\$1583

Optional Glides: Add \$8.00 net per chair for a set of four (4).

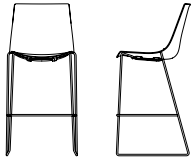

**Amadeus Bar Chair,
Sled Base**

	MODEL	LIST PRICE/GRADE	COM/COL	A	B	C	D	E	F	G	H	I	J	K	L
3D Beech veneer shell, upholstered seat onlay W 21 D 21.5 H 44 SH 30	AMBS-3BU	Powder Coat	\$1667	1715	1739	1763	1787	1811	1835	1859	1883	1907	1931	1955	1979
		Chrome	\$1740	1787	1812	1837	1862	1887	1912	1937	1962	1987	2012	2037	2062

COM Yardage: 1 or 2 seats: .75 yard

Contact Leland Customer Experience for yardage requirements on textiles with repeats.

For COL requirements please contact Leland Customer Experience.

Optional Glides: Add \$8.00 net per chair for a set of four (4).

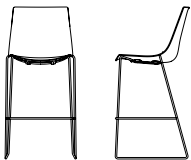

**Amadeus Bar Chair,
Sled Base**

	MODEL	FRAME FINISH	LIST PRICE
3D Walnut veneer shell W 21 D 21.5 H 44 SH 29	AMBS-3DW	Powder Coat	\$1700
		Chrome	\$1774

Optional Glides: Add \$8.00 net per chair for a set of four (4).

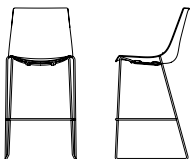

**Amadeus Bar Chair,
Sled Base**

	MODEL	LIST PRICE/GRADE	COM/COL	A	B	C	D	E	F	G	H	I	J	K	L
3D Walnut veneer shell, upholstered seat onlay W 21 D 21.5 H 44 SH 30	AMBS-3WU	Powder Coat	\$1855	1904	1928	1952	1976	2000	2024	2048	2072	2096	2120	2144	2168
		Chrome	\$1929	1976	2001	2026	2051	2076	2101	2126	2151	2176	2201	2226	2251

COM Yardage: 1 or 2 seats: .75 yard

Contact Leland Customer Experience for yardage requirements on textiles with repeats.

For COL requirements please contact Leland Customer Experience.

Optional Glides: Add \$8.00 net per chair for a set of four (4).

To specify:

Please refer to pages 3-4 for complete specifying information. Specify all products by their product code.

Pricing Effective: January 2025

AMADEUS BAR CHAIR, WOOD BASE
Design: Martin Ballendat

AM19



Amadeus Bar Chair

Wood Base

				MODEL	FRAME FINISH	LIST PRICE
Polypropylene shell				AMBW-PO		\$1496
W 20	D 22.5	H 44	SH 29	Optional Glides: Add \$8.00 net per chair for a set of four (4).		

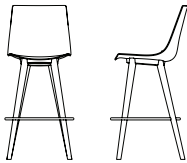

Amadeus Bar Chair

Wood Base

				MODEL	LIST PRICE/GRADE	COM/COL	A	B	C	D	E	F	G	H	I	J	K	L
Polypropylene shell, upholstered seat onlay				AMBW-PU		\$1641	1686	1709	1732	1755	1778	1801	1824	1847	1870	1893	1916	1939
W 20	D 22.5	H 44	SH 29.5	COM Yardage: 1 or 2 seats: .75 yard Contact Leland Customer Experience for yardage requirements on textiles with repeats. Optional Glides: Add \$8.00 net per chair for a set of four (4).														



Amadeus Bar Chair

Wood Base

				MODEL	LIST PRICE/GRADE	COM/COL	A	B	C	D	E	F	G	H	I	J	K	L
Fully upholstered				AMBW-FU		\$1976	2076	2129	2182	2235	2288	2341	2394	2447	2500	2553	2606	2659
W 20	D 22.5	H 44	SH 29.5	COM Yardage: 1 seat: 1.5 yards Contact Leland Customer Experience for yardage requirements on textiles with repeats. Optional Glides: Add \$8.00 net per chair for a set of four (4).														

To specify:

Please refer to pages 3-4 for complete specifying information. Specify all products by their product code.

Pricing Effective: January 2025

AMADEUS BAR CHAIR, WOOD BASE
Design: Martin Ballendat

AM20

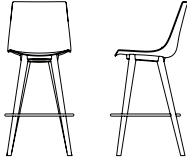

Amadeus Bar Chair

Wood Base

	MODEL	FRAME FINISH	LIST PRICE
3D Beech veneer shell	AMBW-3DB		\$2432
W 20 D 22.5 H 44 SH 29		Optional Glides: Add \$8.00 net per chair for a set of four (4).	

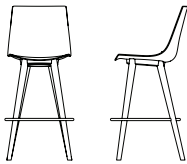

Amadeus Bar Chair

Wood Base

	MODEL	LIST PRICE/GRADE	COM/COL	A	B	C	D	E	F	G	H	I	J	K	L
3D Beech veneer shell, upholstered seat onlay	AMBW-3BU		\$2589	2636	2662	2688	2714	2740	2766	2792	2818	2844	2870	2896	2922
W 20 D 22.5 H 44 SH 29.5		COM Yardage: 1 or 2 seats: .75 yard													
		Contact Leland Customer Experience for yardage requirements on textiles with repeats.													
		Optional Glides: Add \$8.00 net per chair for a set of four (4).													

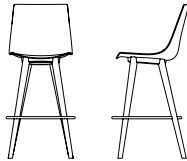

Amadeus Bar Chair

Wood Base

	MODEL	FRAME FINISH	LIST PRICE
3D Walnut veneer shell	AMBW-3DW		\$2799
W 20 D 22.5 H 44 SH 29		Optional Glides: Add \$8.00 net per chair for a set of four (4).	

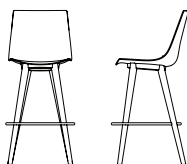

Amadeus Bar Chair

Wood Base

	MODEL	LIST PRICE/GRADE	COM/COL	A	B	C	D	E	F	G	H	I	J	K	L
3D Walnut veneer shell, upholstered seat onlay	AMBW-3WU		\$2955	3003	3027	3051	3075	3099	3123	3147	3171	3195	3219	3243	3267
W 20 D 22.5 H 44 SH 29.5		COM Yardage: 1 or 2 seats: .75 yard													
		Contact Leland Customer Experience for yardage requirements on textiles with repeats.													
		Optional Glides: Add \$8.00 net per chair for a set of four (4).													

To specify:

Please refer to pages 3-4 for complete specifying information. Specify all products by their product code.

Pricing Effective: January 2025

AMADEUS TRANSPORT/STACKING DOLLY

Design: Martin Ballendat

AM21

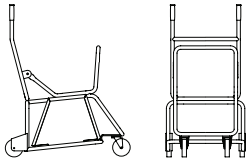

Amadeus

Sled Base

Transport/Stacking Dolly

	MODEL	FRAME FINISH	LIST PRICE
Black powder coat finish	AMD-SB		\$901
W 23.5 D 37.5 H 40 (Dimensions of dolly when empty)		Sled Base: 20 high on dolly (15 high on floor) Weight with 20 high on dolly: 470 lbs For use with all Amadeus sled base, side charis with poly shells, wood shells, and upholstered onlay	
W 23.5 D 37.5 H 70 (Dimensions with 20 poly or wood shell chairs stacked)		**Arm, Counter, & Bar models do not stack	

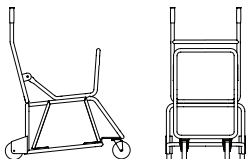

Amadeus

Four Leg Base

Transport/Stacking Dolly

	MODEL	FRAME FINISH	LIST PRICE
Black powder coat finish	AMD-4L		\$1283
W 20 D 22.5 H 44 SH 29.5 (Dimensions of dolly when empty)		Sled Base: 12 high on dolly Weight with 12 high on dolly: 350 lbs For use with all shell types	
W 23.5 D 37.5 H 65 (Dimensions with 12 poly or wood shell chairs stacked)		**Arm, Counter, & Bar models do not stack	

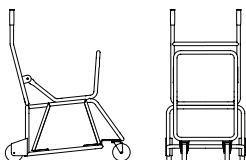

Amadeus

Sled Base, Fully Upholstered

Transport/Stacking Dolly

	MODEL	FRAME FINISH	LIST PRICE
Black powder coat finish	AMD-SBFU		\$1588
W 20 D 22.5 H 44 SH 29.5 (Dimensions with 20 fully upholstered chairs stacked)		Sled Base: 20 high on dolly (15 high on floor) Weight with 20 high on dolly: 530 lbs For use with fully upholstered shell only	
		**Arm, Counter, & Bar models do not stack	

To specify:

Please refer to pages 3-4 for complete specifying information. Specify all products by their product code.

Pricing Effective: January 2025

**5695 Eagle Drive, SE
Grand Rapids,
Michigan 49512
616-975-9260
lelandfurniture.com**

Baraga

January 2025 Price List



Baraga

Table of Contents	BA2
Specification Information	BA3
Specification Example	BA4
Bar Stool	BA5
Counter Stool	BA5
Low Stool	BA5

Chair Model

DESCRIPTION	CODE
Baraga Bar Stool	BARB
Baraga Counter Stool	BARC
Baraga Low Stool	BARS

Seat Type

DESCRIPTION	CODE
Oak	O
Walnut	W
Beech	BE
Felt	F
Upholstery	U

Wood Seat Finish

DESCRIPTION	CODE
Natural Walnut	08M
Natural White Oak	12M
Natural Beech	09M
Morel	66M
Evergreen	112M
Sienna	113M
Blue Sky	114M

Felt Seat Finish

DESCRIPTION	CODE
Abalone	PET01
Salmon	PET02
Sandstone	PET03
Bark	PET04
Amarillo	PET05
Shamrock	PET06
Burnt Clay	PET07
Merlot	PET08
Royal	PET09
Indigo	PET10
Turmeric	PET11
Laurel	PET12
Charcoal	PET13

Powder Coat Frame Finish

DESCRIPTION	CODE
Black Textured	BT
White Textured	WT
Matte Mercury	MMR
Matte Burnish	MBN
Matte Foundry	MFN
Matte Pine	MPN
Matte Sienna	MSN
Matte Blue Sky	MBS

Glide Type

STANDARD:	
DESCRIPTION	CODE
Nylon	S

OPTIONAL:
Please note that optional glides raise the chair height .5 inch.

DESCRIPTION	CODE
Felt	FC

Stacking note

The Baraga stool does not stack.

Specifications required to create the product code

- Model
- Wood Species
- Seat Finish
- Frame Finish
- Glide Type

B
A
R
C
-
F
-
P
E
T
1
1
-
B
T
-
S

MODEL

Baraga Counter Stool

SEAT TYPE

Felt (F)

SEAT FINISH

Turmeric (PET11)

FRAME FINISH

Black Textured (BT)

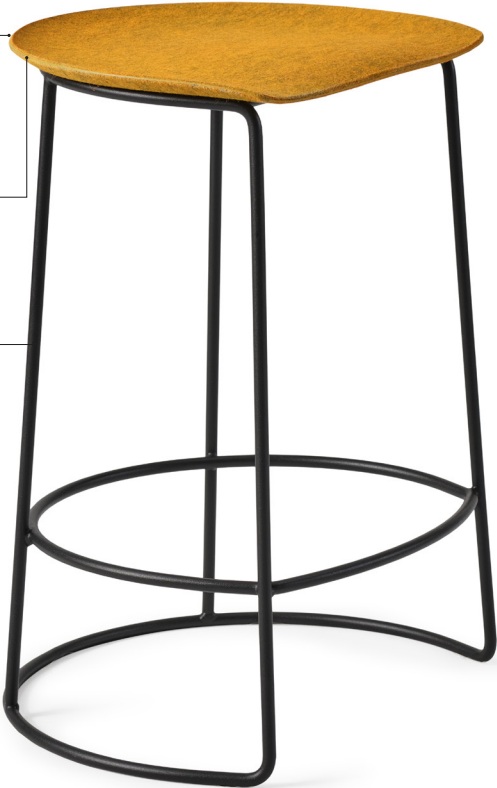

BARAGA STOOL
Design: Altherr Désile Park

BA5



Baraga Bar Stool

	MODEL	SEAT TYPE	LIST PRICE
Powder Coat Frame	BARB-BE	Beech	\$727
W 20 D 16 H 30	BARB-O	Oak	\$1011
	BARB-W	Walnut	\$1021
	BARB-F	Felt	\$1037
	BARB-U	Upholstery	\$762

Optional Glides: Add \$8.00 net per chair for a set of four (4). Optional Glides raise chair height .5 inch.



Baraga Counter Stool

	MODEL	SEAT TYPE	LIST PRICE
Powder Coat Frame	BARC-BE	Beech	\$710
	BARC-O	Oak	\$980
W 20 D 16 H 25	BARC-W	Walnut	\$999
	BARC-F	Felt	\$1015
	BARC-U	Upholstery	\$746

Optional Glides: Add \$8.00 net per chair for a set of four (4). Optional Glides raise chair height .5 inch.



Baraga Low Stool

	MODEL	SEAT TYPE	LIST PRICE
Powder Coat Frame	BARS-BE	Beech	\$695
	BARS-O	Oak	\$966
W 19 D 15 H 18	BARS-W	Walnut	\$977
	BARS-F	Felt	\$992
	BARS-U	Upholstery	\$730

Optional Glides: Add \$8.00 net per chair for a set of four (4). Optional Glides raise chair height .5 inch.

To specify:
Please refer to pages 3-4 for complete specifying information.
Specify all products by their product code.

Pricing Effective: January 2025

5695 Eagle Drive, SE
Grand Rapids,
Michigan 49512
616-975-9260
lelandfurniture.com

Beach Stone Collection

January 2025 Price List



Beach Stones

Table of Contents	BS2
Specification Information	BS3
Specification Example	BS4
Seating	BS5
Tables	BS7

Model

DESCRIPTION	CODE
Beach Stone E	BSE
Beach Stone E with casters	BSEM
Beach Stone F	BSF
Beach Stone F with casters	BSFM
Beach Stone G	BSG
Beach Stone G with casters	BSGM
Beach Stone H	BSH
Beach Stone I	BSI
Beach Stone J	BSJ
Beach Stone K	BSK
Beach Stone L	BSL

Product Weights

DESCRIPTION	LBS
Beach Stone E - BSE	50
Beach Stone F - BSF	50
Beach Stone G - BSG	50
Beach Stone H - BSH	50
Beach Stone I - BSI	50
Beach Stone J - BSJ	50
Beach Stone K - BSK	50
Beach Stone L - BSL	50

Upholstery Selection

Please refer to freshcoast Textile Program which features textiles and leathers from the following partners:

- Camira
- Carnegie
- CF Stinson
- Green Hides
- Maharam
- Unika Vaev

The complete grade list can be found at www.fc.studio/textile-partners or you can specify COM/COL. Due to the design of this product, it is recommended that all non pre-approved textile be tested for compatibility.

Contact freshcoast for yardage requirements on textiles with repeats.

Base Finish

Black textured powder coat

Table Top Finish

LAMINATE

DESCRIPTION	CODE
Black Laminate	LBK
White Laminate	LWH

SOLID SURFACE

DESCRIPTION	CODE
Black Lava	FR501
Frost	FR103
Luna Steel	FR415

GLASS

DESCRIPTION	CODE
Black Back Painted Glass	BG
White Back Painted Glass	WG

Specifications required to create the product code

- Model
- Upholstery Selection
- Table Top Finish (when applicable)
- Caster Option (when applicable)

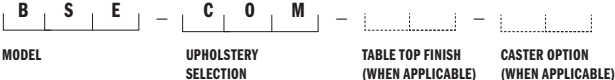

MODEL

Beach Stone E

UPHOLSTERY SELECTION

Upholstered (COM)





Beach Stone E

	MODEL	COM/COL	A	B	C	D	E	F	G	H	I	J	K	L
Fully upholstered	BSE	\$1663	1854	1951	2048	2145	2242	2339	2436	2533	2630	2727	2824	2921

W 32 D 24 H 25 SH 18

COM Yardage: 2.5 yards

Contact freshcoast customer care for COL requirements, textile testing requirements and yardage requirements for textiles with repeats.

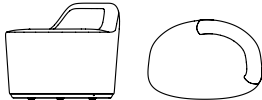

Beach Stone E with caster

	MODEL	COM/COL	A	B	C	D	E	F	G	H	I	J	K	L
Fully upholstered locking caster base	BSEM-HF	\$1736	1927	2023	2119	2215	2311	2407	2503	2599	2695	2791	2887	2983

Hard or soft floor casters

BSEM-SF

\$1750

1941

2038

2135

2232

2329

2426

2523

2620

2717

2814

2911

3008

W 32 D 24 H 25.25 SH 18.25

COM Yardage: 2.5 yards

Contact freshcoast customer care for COL requirements, textile testing requirements and yardage requirements for textiles with repeats.



Beach Stone F

	MODEL	COM/COL	A	B	C	D	E	F	G	H	I	J	K	L
Fully upholstered	BSF	\$1637	1828	1924	2020	2116	2212	2308	2404	2500	2596	2692	2788	2884

W 32 D 24 H 26 SH 18

COM Yardage: 2.5 yards

Contact freshcoast customer care for COL requirements, textile testing requirements and yardage requirements for textiles with repeats.

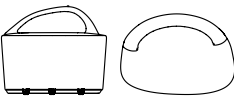

Beach Stone F with caster

	MODEL	COM/COL	A	B	C	D	E	F	G	H	I	J	K	L
Fully upholstered locking caster base	BSFM-HF	\$1708	1900	1995	2090	2185	2280	2375	2470	2565	2660	2755	2850	2945

Hard or soft floor casters

BSFM-SF

\$1723

1914

2010

2106

2202

2298

2394

2490

2586

2682

2778

2874

2970

W 32 D 24 H 26.25 SH 18.25

COM Yardage: 2.5 yards

Contact freshcoast customer care for COL requirements, textile testing requirements and yardage requirements for textiles with repeats.

To specify:

Please refer to pages 3-4 for complete specifying information.

Specify all products by their product code.

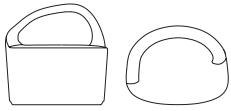

Beach Stone G		MODEL	COM/COL	A	B	C	D	E	F	G	H	I	J	K	L
Fully upholstered		BSG	\$1656	1849	1945	2041	2137	2233	2329	2425	2521	2617	2713	2809	2905
W 32	D 24	H 31	SH 18	COM Yardage: 2.5 yards											
Contact freshcoast customer care for COL requirements, textile testing requirements and yardage requirements for textiles with repeats.															

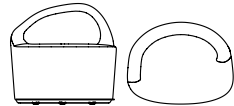

Beach Stone G with caster		MODEL	COM/COL	A	B	C	D	E	F	G	H	I	J	K	L
Fully upholstered locking caster base		BSGM-HF	\$1727	1921	2016	2111	2206	2301	2396	2491	2586	2681	2776	2871	2966
Hard or soft floor casters		BSGM-SF	\$1743	1936	2032	2128	2224	2320	2416	2512	2608	2704	2800	2896	2992
W 32	D 24	H 31.25	SH 18.25	COM Yardage: 2.5 yards											
Contact freshcoast customer care for COL requirements, textile testing requirements and yardage requirements for textiles with repeats.															



Beach Stone H		MODEL	COM/COL	A	B	C	D	E	F	G	H	I	J	K	L
Fully upholstered		BSH	\$1103	1295	1391	1487	1583	1679	1775	1871	1967	2063	2159	2255	2351
W 48	D 18	H 18	COM Yardage: 2.5 yards												
Contact freshcoast customer care for COL requirements, textile testing requirements and yardage requirements for textiles with repeats.															



Beach Stone I		MODEL	COM/COL	A	B	C	D	E	F	G	H	I	J	K	L
Fully upholstered		BSI	\$994	1123	1186	1249	1312	1375	1438	1501	1564	1627	1690	1753	1816
W 33	D 22	H 18	COM Yardage: 1.75 yards												
Contact freshcoast customer care for COL requirements, textile testing requirements and yardage requirements for textiles with repeats.															

To specify:
 Please refer to pages 3-4 for complete specifying information.
 Specify all products by their product code.

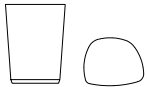

Beach Stone J			MODEL	TOP FINISH	COM/COL	A	B	C	D	E	F	G	H	I	J	K	L
Upholstered w/ table			BSJ	Laminate	\$1162	1225	1258	1291	1324	1357	1390	1423	1456	1489	1522	1555	1588
W 17 D 13 H 22				Solid Surface	\$1742	1839	1887	1935	1983	2031	2079	2127	2175	2223	2271	2319	2367

COM Yardage: 1 yard

Contact freshcoast customer care for COL requirements, textile testing requirements and yardage requirements for textiles with repeats.

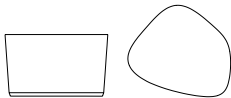

Beach Stone K			MODEL	TOP FINISH	COM/COL	A	B	C	D	E	F	G	H	I	J	K	L
Upholstered w/ table			BSK	Laminate	\$1162	1289	1353	1417	1481	1545	1609	1673	1737	1801	1865	1929	1993
W 30 D 27 H 18				Solid Surface	\$1742	1933	2030	2127	2224	2321	2418	2515	2612	2709	2806	2903	3000

COM Yardage: 2 yards

Contact freshcoast customer care for COL requirements, textile testing requirements and yardage requirements for textiles with repeats.

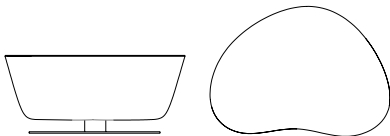

Beach Stone L			MODEL	TOP FINISH	COM/COL	A	B	C	D	E	F	G	H	I	J	K	L
Upholstered w/ table			BSL	Laminate	\$3632	3825	3920	4015	4110	4205	4300	4395	4490	4585	4680	4775	4870
W 47 D 34 H 20				Solid Surface	\$5449	5737	5880	6023	6166	6309	6452	6595	6738	6881	7024	7167	7310

COM Yardage: 3 yards

Contact freshcoast customer care for COL requirements, textile testing requirements and yardage requirements for textiles with repeats.

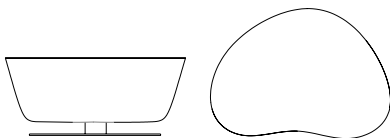

Beach Stone L			MODEL	COM/COL	A	B	C	D	E	F	G	H	I	J	K	L
Upholstered w/ backpainted glass			BSL	\$3963	4155	4250	4345	4440	4535	4630	4725	4820	4915	5010	5105	5200
W 33 D 22 H 18																

COM Yardage: 3 yards

Contact freshcoast customer care for COL requirements, textile testing requirements and yardage requirements for textiles with repeats.

To specify:
 Please refer to pages 3-4 for complete specifying information.
 Specify all products by their product code.

**5695 Eagle Drive, SE
Grand Rapids,
Michigan 49512
616-975-9260
lelandfurniture.com**

Bimini

January 2025 Price List



Bimini

Table of Contents	BI-2
Specification Information	BI-3
Specification Example	BI-4
Bimini Order Diagram	BI-5
Bimini High Panel	BI-6
Bimini Low Panel	BI-7
Bimini Accessory	BI-8
Bimini Auxiliary	BI-9

Bimini Model

DESCRIPTION	CODE
Bimini High Panel Desk Height	BIHD
Bimini High Panel Counter Height	BIHC
Bimini High Panel Free Standing	BIHF
Bimini Low Panel Desk Height	BILD
Bimini Low Panel Counter Height	BILC
Bimini Low Panel Free Standing	BILF

Panel Finish

DESCRIPTION	CODE
Abalone	PET01
Shamrock	PET06
Burnt Clay	PET07
Merlot	PET08
Royal	PET09
Turmeric	PET11
Laurel	PET12
Charcoal	PET13

Top Type

DESCRIPTION	CODE
Oak	O
Walnut	W
Laminate	L

Top Finish Options

OAK FINISH OPTIONS

DESCRIPTION	CODE
Natural White Oak	12M
Morel	66M

WALNUT FINISH OPTIONS

DESCRIPTION	CODE
Natural Walnut	08M

LAMINATE FINISH OPTIONS

DESCRIPTION	CODE
Platinum Wilsonart® (D315-60)	LGP
Black Pionite® (SE101)	LBK
White Wilsonart® (D354-60)	LWH

Rail Finish

DESCRIPTION	CODE
Black Textured	BT

Table Accessory Position 1-5 Option

DESCRIPTION	CODE
Salt USB	USB
Pepper Power	PWR
Pippa Light	PPL
Monitor Mount & Grommet (Left side)	GML
Monitor Mount & Grommet (Right side) (White or Black)	GMR

Auxiliary Options

DESCRIPTION	CODE
Coat Hook	CHK
Bag Hook	BHK
Customizable Signage	CSG
Linking Set 2 Panels	2LS
Linking Set 3 Panels	3LS

Table Edge Type

DESCRIPTION	CODE
1" flat plywood	W2



Specifications required to create the product code

- Model
- Panel Finish
- Top Type
- Top Finish
- Rail Finish
- Table Accessory Option
- Auxiliary Option



MODEL

Bimini High Panel Desk Height (BIHD)

PANEL FINISH

Royal (PET11)

TOP TYPE

Laminate (L)

TOP FINISH

Designer White D354-60 (LWH)
(when applicable)

RAIL FINISH

Black Textured (BT)



1. Accessorize your Bimini

Please complete and include with your order. If multiple units are ordered, a diagram must be completed for each unique unit.

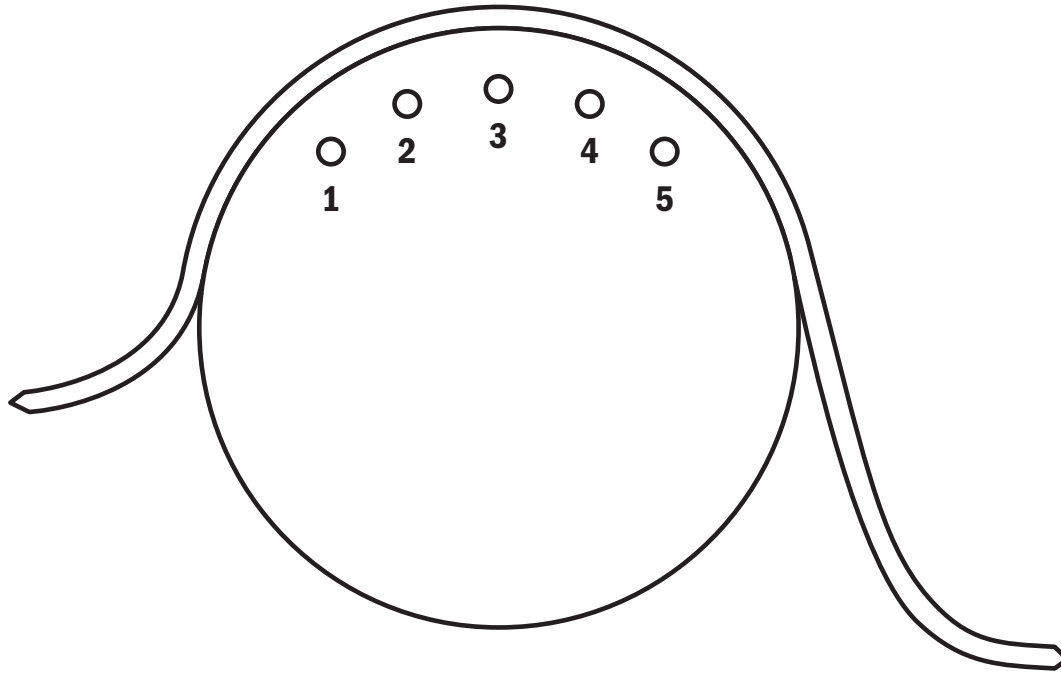

2. Check the box that fits your need

Salt (any position on table), Pepper (any position on table), Pippa (any position if no Monitor Mount). Monitor (any position on table with grommet in position next to mount) Monitors (less than 24") and Pippa (mount in 1 or 2 and Pippa in 5/Pippa in 1 and mount in 4 or 5), Monitors (24"-32") and Pippa (mount in 1 and Pippa in 5/Pippa in 1 and mount in 5).

POSITION ONE	POSITION TWO	POSITION THREE	POSITION FOUR	POSITION FIVE
<input type="checkbox"/> No Accessory Accessory <input type="checkbox"/> Salt USB <input type="checkbox"/> Pepper Power <input type="checkbox"/> Pippa Light <input type="checkbox"/> Monitor Mount & Grommet (Right Side)	<input type="checkbox"/> No Accessory Accessory <input type="checkbox"/> Salt USB <input type="checkbox"/> Pepper Power <input type="checkbox"/> Pippa Light <input type="checkbox"/> Monitor Mount & Grommet (Right Side) <input type="checkbox"/> Monitor Mount & Grommet (Left Side)	<input type="checkbox"/> No Accessory Accessory <input type="checkbox"/> Salt USB <input type="checkbox"/> Pepper Power <input type="checkbox"/> Pippa Light <input type="checkbox"/> Monitor Mount & Grommet (Right Side) <input type="checkbox"/> Monitor Mount & Grommet (Left Side)	<input type="checkbox"/> No Accessory Accessory <input type="checkbox"/> Salt USB <input type="checkbox"/> Pepper Power <input type="checkbox"/> Pippa Light <input type="checkbox"/> Monitor Mount & Grommet (Right Side) <input type="checkbox"/> Monitor Mount & Grommet (Left Side)	<input type="checkbox"/> No Accessory Accessory <input type="checkbox"/> Salt USB <input type="checkbox"/> Pepper Power <input type="checkbox"/> Pippa Light <input type="checkbox"/> Monitor Mount & Grommet (Left Side)

BIMINI, HIGH PANEL
 Design: Altherr Désile Park

BI-6

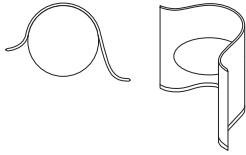

Bimini
High Panel, Desk Height

	MODEL	BASE	LAMINATE TOP	WALNUT TOP	OAK TOP
56" Panel, 29" Height Table	BIHD	Powder Coat	\$5790	\$5975	\$5975
W 69 D 43.5 H 56 TH 29					

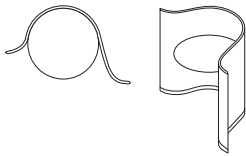

Bimini
High Panel, Counter Height

	MODEL	BASE	LAMINATE TOP	WALNUT TOP	OAK TOP
56" Panel, 29" Height Table	BIHC	Powder Coat	\$5990	\$6175	\$6175
W 69 D 43.5 H 56 TH 36					

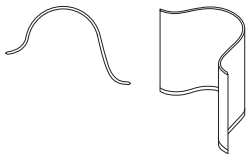

Bimini
High Panel, Free Standing

	MODEL	BASE	LIST PRICE
56" Panel, 29" Height Table	BIHF	Powder Coat	\$4975
W 69 D 43.5 H 56			

To specify:
 Please refer to pages 3-4 for complete specifying information.
 Specify all products by their product code.

BIMINI, LOW PANEL
Design: Altherr Désile Park

BI-7

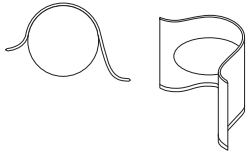

Bimini

Low Panel, Desk Height

	MODEL	BASE	LAMINATE TOP	WALNUT TOP	OAK TOP
56" Panel, 29" Height Table	BILD	Powder Coat	\$5640	\$5825	\$5825
W 69 D 43.5 H 56 TH 29					

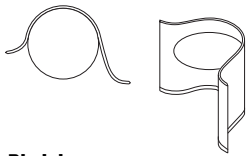

Bimini

Low Panel, Counter Height

	MODEL	BASE	LAMINATE TOP	WALNUT TOP	OAK TOP
56" Panel, 29" Height Table	BILC	Powder Coat	\$5840	\$6025	\$6025
W 69 D 43.5 H 56 TH 36					

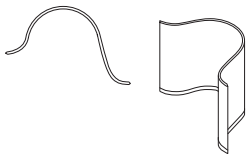

Bimini

Low Panel, Free Standing

	MODEL	BASE	LIST PRICE
56" Panel, 29" Height Table	BILF	Powder Coat	\$4775
W 69 D 43.5 H 56			

To specify:
Please refer to pages 3-4 for complete specifying information.
Specify all products by their product code.

Pricing Effective: January 2025



Salt - Dual USB Charger		MODEL	LIST PRICE
White, Black		USB Starter Unit (Includes one Salt and four port power box)	\$655
Dia 2" H 0.125"		Add on Unit (includes on salt only)	\$255

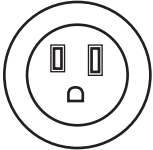

Pepper-Power Receptacle		MODEL	LIST PRICE
White, Black		PWR Start Unit (Includes one Pepper and four port power box)	\$543
Dia 2" H 0.125"		Add on Unit (includes one pepper only)	\$143

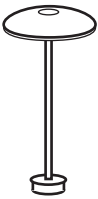

Pippa Light		MODEL	LIST PRICE
White, Black		PPL Starter Unit (Includes one Pippe light and four power power box)	\$875
Dia 6.29" H 16.125"		Add on Unit (includes one Pippa light only)	\$475

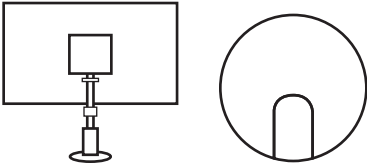

Monitor Mount & Grommet		MODEL	LIST PRICE
56" Panel, 29" Height Table		MMT Starter Unit (Includes one Monitor Mount with Grommet and four port power box)	\$855
W 69 D 43.5 H 56 TH 29		Add on Unit (includes on Monitor Mount with Grommet only)	\$455

*One Starter Unit required per Bimini
 *Power box has 12' cord length

To specify:
 Please refer to pages 3-4 for complete specifying information.
 Specify all products by their product code.



Customizable Signage	MODEL	LIST PRICE
Alphanumeric Character Dia 6" Decal 4"	CSG	\$459

Bag Hook	MODEL	LIST PRICE
Under Table Top	BHK	\$168



Coat Hook	MODEL	LIST PRICE
Oak Or Walnut	CHK	\$245

Coat Hook Located on inside of Panel, 4" from top and 10" from Right hand side



Link Set	MODEL	LIST PRICE
Link 2 Bimini	2LS	\$235



120 Link Set	MODEL	LIST PRICE
Link 3 Bimini	3LS	\$265

To specify:
 Please refer to pages 3-4 for complete specifying information.
 Specify all products by their product code.

5695 Eagle Drive, SE
Grand Rapids,
Michigan 49512
616-975-9260
lelandfurniture.com

Brit Bench Metallic

January 2025 Price List

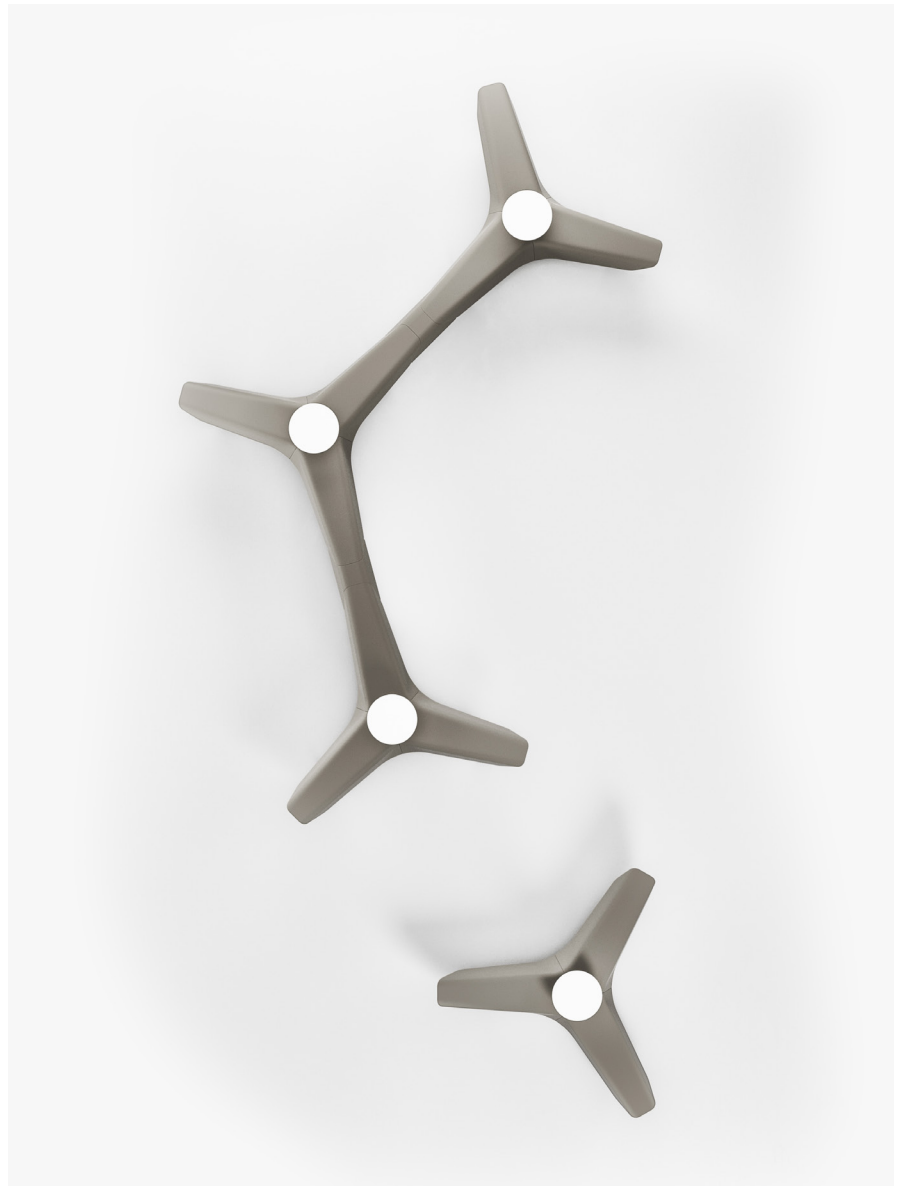

Brit Bench Metallic

Table of Contents	BBM2
Specification Information	BBM3
Specification Example	BBM4
Powder Coat Steel, Upholstered Seat Onlay	BBM5
Auxiliary Options	BBM6
Link Specification Information	BBM7
Link Specification Example	BBM8
Brit Bench Metallic Link	BBM9
Auxiliary Options	BBM10

Bench Model

DESCRIPTION	CODE
Brit Bench metallic powder coat steel	BBPC
Brit Bench metallic powder coat steel, with powder coat steel table	BBPCT
Brit Bench metallic powder coat steel, upholstered onlay	BBPCU with
Brit Bench metallic powder coat steel, with powder steel table, with upholstered onlay	BBPCTU coat

Leg Finish

DESCRIPTION	CODE
Brushed Stainless Steel	BSS
Black Powder Coat	BPC

Powder Coat Steel Finish

DESCRIPTION	CODE
Black Textured Powder Coat	BT
Soda Red Textured	SRT
Dolphin Textured	DLT
Oxford Textured	OXT
Tangerine Textured	TNT
Ice Blue Textured	IBT
Artic Textured	ART
Caribbean Textured	CBT
Limelight Textured	LLT
Ink Textured	IN

Upholstered Onlay Selection

Please refer to Leland Textile Program which features textiles and leathers from the following partners:

- Camira
- Carnegie
- CF Stinson
- Green Hides
- Maharam
- Unika Vaev

The complete grade list can be found on our website or you can specify COM/COL. Due to the design of this product, it is recommended that all non pre-approved textile be tested for compatibility.

Upholstered onlay is not an option for the Brit Bench Metallic link.

Table Top Surface

DESCRIPTION	CODE
Corian® Solid Surface Solid with 0.5" square edge	SSS

Contact Corian® Solid Surface for current solid and pattern availability. A custom quote is required for all solid surface. Please contact Leland Customer Experience to request a custom quote.

Auxiliary Options

DESCRIPTION	CODE
Brit Bench Electrical outlets, (with table)	BBE0
Brit Bench Floor Mount	BBFM
Brit Bench Security Pan	BSP
Outdoor Treatment	OT

Glides

Brit Bench glides are nylon.

Product Specification

Brit Bench product layout is required at the quotation stage and order stage to ensure accurate product specifications. Contact Leland Customer Experience for CAD symbols.

Shipment Detail

Please note that Brit Bench products will be shipped unassembled. Please contact Customer Experience if assembled shipment is desired as additional charges will apply.

Specifications required to create the product code

BRIT BENCH METALLIC (WITHOUT TABLE)

- Model
- Leg Finish
- Powder Coat Steel Finish (when applicable)
- Upholstery Selection (when applicable)
- Auxiliary Options (when applicable)



BRIT BENCH METALLIC (WITH TABLE)

- Model
- Leg Finish
- Powder Coat Steel Finish (when applicable)
- Upholstered Onlay Selection (when applicable)
- Table Top Surface
- Surface Color (when applicable)
- Auxiliary Options (when applicable)

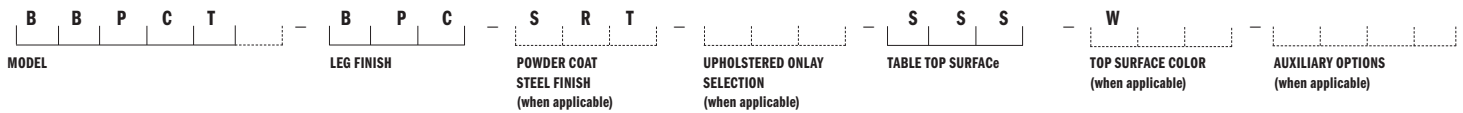

MODEL

Brit Bench Metallic Powder Coat Steel, with Powder Coat Steel Table (BBPCT)

LEG FINISH

Brushed Stainless Steel (BPC)

POWDER COAT STEEL FINISH

Soda Red Textured (SRT)

UPHOLSTERED ONLAY SELECTION

When applicable, enter upholstery grade, COM or COL

TABLE TOP SURFACE

SSS

TOP SURFACE COLOR

Corian® White Solid Surface (CW)

AUXILIARY OPTIONS

When applicable, enter auxiliary option code

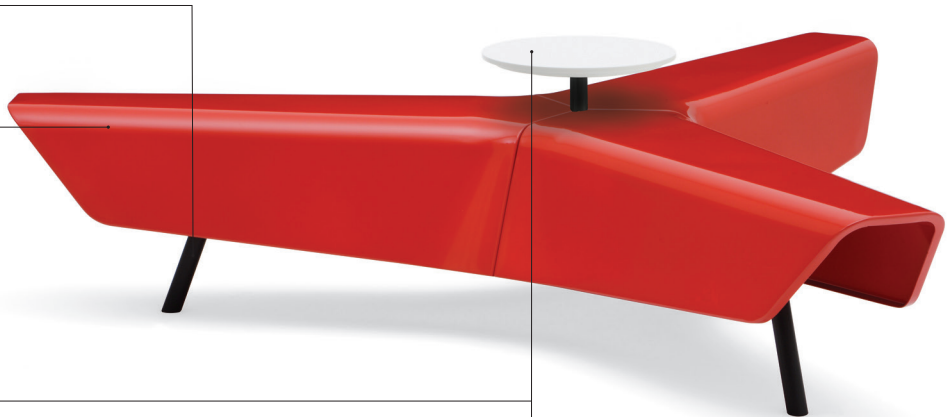

BRIT BENCH METALLIC POWDER COAT STEEL
 Design: Simon Pengelly

BBM5



Brit Bench Metallic

LIST PRICE

Powder coat steel	BBPC 1-3 units	\$10705
W 81 SH 18.5	BBPC 4+ units	\$9221



Brit Bench Metallic

LIST PRICE

Powder coat steel, steel table	BBPCT 1-3 units	\$12289
W 81 SH 18.5	BBPCT 4+ units	\$10803

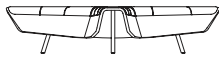

Brit Bench Metallic

LIST PRICE/GRADE

COM/COL

A B C D E F G H I J K L

Powder coat steel	BBPCU 1-3 units	\$11456	11775	11937	12099	12261	12423	12585	12747	12909	13071	13233	13395	13557
upholstered seat only	BBPCU 4+ units	\$9968	10290	10449	10608	10767	10926	11085	11244	11403	11562	11721	11880	12039

COM Yardage: 1 bench: 4 yards

For COL requirements please contact Leland Customer Experience.

W 81 SH 19.5



Brit Bench Metallic

LIST PRICE/GRADE

COM/COL

A B C D E F G H I J K L

Powder coat steel, steel table	BBPCTU 1-3 units	\$13035	13355	13516	13677	13838	13999	14160	14321	14482	14643	14804	14965	15126
upholstered seat only	BBPCTU 4+ units	\$11551	11870	12030	12190	12350	12510	12670	12830	12990	13150	13310	13470	13630

COM Yardage: 1 bench: 4 yards

For COL requirements please contact Leland Customer Experience.

W 81 SH 19.5

Brit Bench Table Top

MODEL

Corian® Solid Surface Circular Top	SSS
---------------------------------------	-----

Contact Corian® Solid Surface for current solid and pattern availability.
 A custom quote is required for all solid surface. Please contact Leland Customer Experience to request a custom quote.

To specify:

Please refer to pages 3-4 for complete specifying information.
 Specify all products by their product code.

Pricing Effective: January 2025

BRIT BENCH METALLIC AUXILIARY OPTIONS

Design: Simon Pengelly

BBM6

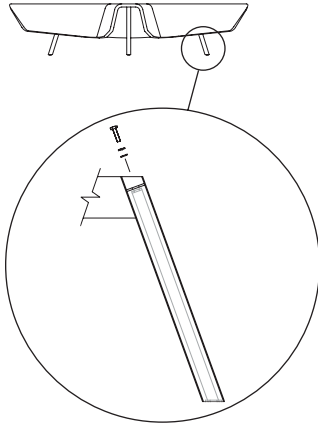

Brit Bench Floor Mount

LIST PRICE

BBFM

\$224

Due to the variety of floor surfaces on which the Brit Bench may be installed, floor mount fasteners are not supplied by Leland International. The Brit Bench floor mount feature consists of legs with floor mount brackets designed to use .3125 thread diameter fasteners. Responsibility of fastener choice is the customers. Brit Bench Floor Mount must be specified at the time of purchasing. The Floor Mount cannot be added later in the field.

Brit Bench Security Pan

LIST PRICE

BBSP

\$1868

Brit Bench Electrical Outlet

LIST PRICE

For table

BBEO

\$1237

Brit Bench electrical outlet option is not standard for all Brit Bench tables. Electrical outlet is located under the table edge, therefore a Brit Bench with table must be specified when specifying electrical outlet option.

Brit Bench electrical outlet option features on 120v AC receptacle.

Outdoor Treatment

LIST PRICE

powder coat steel bench

OT

\$412

To specify:

Please refer to pages 3-4 for complete specifying information.

Specify all products by their product code.

Pricing Effective: January 2025

Link Model

DESCRIPTION	CODE
Brit Bench Metallic Link powder coat steel	BBLPC

Powder Coat Steel Finish

DESCRIPTION	CODE
White Textured Powder Coat	WT
Black Textured Powder Coat	BT
Grey Textured Powder Coat	GT
Soda Red Textured	SRT
Dolphin Textured	DLT
Oxford Textured	OXT
Tangerine Textured	TNT
Ice Blue Textured	IBT
Artic Textured	ART
Caribbean Textured	CBT
Limelight Textured	LLT
Ink Textured	IN

Auxiliary Options

DESCRIPTION	CODE	DESCRIPTION	CODE
Brit Bench Link Security Pan			BBLSP
Outdoor Treatment			OT

Product Specification

Brit Bench product layout is required at the quotation stage and order stage to ensure accurate product specifications. Contact Leland Customer Experience for CAD symbols.

Shipment Details

Please note that Brit Bench products will be shipped unassembled.
Please contact Customer Experience if assembled shipment is desired as additional charges will apply.

Specifications required to create the product code

- Model
- Powder Coat Steel Finish (when applicable)
- Upholstery Selection (when applicable)
- Outdoor Treatment (when applicable)
- Auxiliary Options (when applicable)



MODEL

Brit Bench Metallic Link Powder Coat Steel (BBLPC)

POWDER COAT STEEL FINISH

Artic Textured (ART)

OUTDOOR TREATMENT

When applicable

AUXILIARY OPTIONS

When applicable, enter auxiliary option code

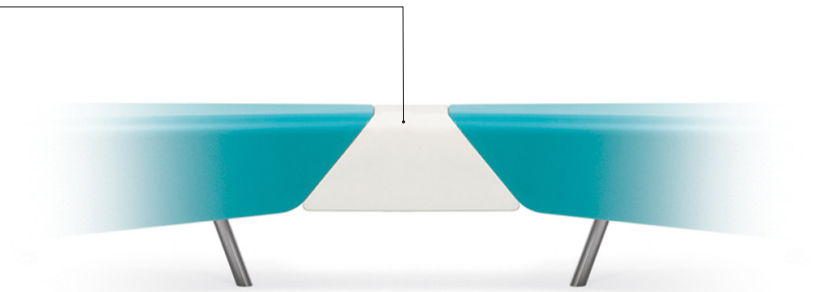

BRIT BENCH METALLIC LINK
Design: Simon Pengelly

BBM9

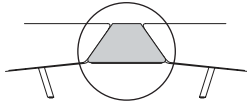

Brit Bench Metallic Link	MODEL	FRAME FINISH	LIST PRICE
powder coat steel link	BBLPC		\$1220

W 7.875

Upholstered onlay is not an option for the Brit Bench Metallic Powder Coat Steel Link.

To specify:
Please refer to pages 3-4 for complete specifying information.
Specify all products by their product code.

Pricing Effective: January 2025

Brit Bench Link Security Pan	MODEL	FRAME FINISH	LIST PRICE
	BBLSP		\$408

Brit Bench Link Security Pan must be specified at the time of purchasing.
The Link Security Pan cannot be added later in the field.

Outdoor Treatment	MODEL	FRAME FINISH	LIST PRICE
powder coat steel link	OT		\$134

To specify:
Please refer to pages 3-4 for complete specifying information.
Specify all products by their product code.

5695 Eagle Drive, SE
Grand Rapids,
Michigan 49512
616-975-9260
lelandfurniture.com

Café Parfait

January 2025 Price List



Café Parfait

Table of Contents	CP2
Specification Information	CP3
Specification Example	CP4
Side Chair	CP5
Counter Chair	CP6
Bar Chair	CP7
Transport/Stacking Dolly	CP8

Chair Model

DESCRIPTION	CODE
Café Parfait side chair, upholstered seat, wood back	CPSUW
Café Parfait side chair, wood seat, wood back	CPSWW
Café Parfait counter chair, upholstered seat, wood back	CPCUW
Café Parfait counter chair, wood seat, wood back	CPCWW
Café Parfait bar chair, upholstered seat, wood back	CPBUW
Café Parfait bar chair, wood seat, wood back	CPBWW

Upholstery Selection**POLYPROPYLENE SHELL:**

Please refer to Leland Textile Program which features textiles and leathers from the following partners:

- Camira
- Green Hides
- Carnegie
- Maharam
- CF Stinson
- Unika Vaev

The complete grade list can be found on our website or you can specify COM/COL. Due to the design of this product, it is recommended that all non pre-approved textile be tested for compatibility.

Seat and Back Wood Finish**STANDARD LELAND COLORS**

CUSTOM Specify Custom (01)

*Please note that Café Parfait is NOT AVAILABLE in the following finishes:

Natural Walnut Matte (08M), Natural Beech (09), Natural White Oak Matte (12M)

Frame Finishes

DESCRIPTION	CODE
Sterling	ST
Warm Grey	WG
Cool Grey	CG
Black	B
White	W
Matte Mercury	MMR
Matte Mineral	MMN
Matte Burnish	MBN
Matte Foundry	MFN

TEXTURED

DESCRIPTION	CODE
Dolphin Textured	DLT
Oxford Textured	OXT
Black Textured	BT
White Textured	WT
Matte Blue Sky	MBS
Matte Forest	MFO
Matte Sienna	MSN
Matte Willow	MWL

Glide Type**STANDARD:**

DESCRIPTION	CODE
Nylon	S

OPTIONAL:

DESCRIPTION	CODE
Felt	FC
Floor Saver™ (for VCT type floors)	FS
Metal	M
Rubber	R

Please note that optional glides raise the chair height .5 inch.

Specifications required to create the product code

- Model
- Seat Upholstery or Finish
- Back Finish
- Frame Finish
- Glide Type



MODEL

Café Parfait Side Chair -
wood seat, wood back
(CPSWW)

SEAT UPHOLSTERY OR FINISH

Aegean (78)

BACK FINISH

Sea Grass (79)

FRAME FINISH

Sterling (ST)



CAFÉ PARFAIT SIDE CHAIR
 Design: Leland Design Group

CP5



Café Parfait Side Chair		MODEL	LIST PRICE
Wood seat, wood back		CPSWW	\$705
W 19	D 20	H 31	SH 19

Optional Glides: Add \$8.00 net per chair for a set of four (4). Optional Glides raise chair height .5 inch.



Café Parfait Side Chair		MODEL	LIST PRICE/GRADE	COM/COL	A	B	C	D	E	F	G	H	I	J	K	L
3D Beech veneer shell, upholstered seat onlay		CPSUW		\$656	689	708	727	746	765	784	803	822	841	860	879	898
W 19	D 20	H 31	SH 19													

Optional Glides: Add \$8.00 net per chair for a set of four (4). Optional Glides raise chair height .5 inch.
 COM Yardage: 1 or 2 seats: .75 yard; 3 or 4 seats: 1.25 yards
 Contact Leland Customer Experience for yardage requirements on textiles with repeats.
 For COL requirements please contact Leland Customer Experience.

To specify:
 Please refer to pages 3-4 for complete specifying information.
 Specify all products by their product code.

Pricing Effective: January 2025

CAFÉ PARFAIT COUNTER CHAIR
 Design: Leland Design Group

CP6

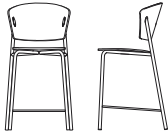

Café Parfait Counter Chair	MODEL	LIST PRICE
Wood seat, wood back	CPCWW	\$974
W 18.5 D 23 H 37.75 SH 25	Optional Glides: Add \$8.00 net per chair for a set of four (4). Optional Glides raise chair height .5 inch.	

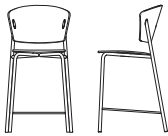

Café Parfait Counter Chair	MODEL	LIST PRICE/GRADE	COM/COL	A	B	C	D	E	F	G	H	I	J	K	L
3D Beech veneer shell, upholstered seat onlay	CPCUW		\$931	962	980	998	1016	1034	1052	1070	1088	1106	1124	1142	1160
			Optional Glides: Add \$8.00 net per chair for a set of four (4). Optional Glides raise chair height .5 inch.												
			COM Yardage: 1 or 2 seats: .75 yard; 3 or 4 seats: 1.25 yards												
W 18.5 D 23 H 37.75			Contact Leland Customer Experience for yardage requirements on textiles with repeats.												
SH 25.5			For COL requirements please contact Leland Customer Experience.												

To specify:
 Please refer to pages 3-4 for complete specifying information.
 Specify all products by their product code.

Pricing Effective: January 2025

CAFÉ PARFAIT BAR CHAIR
 Design: Leland Design Group

CP7

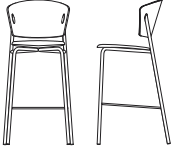

Café Parfait Bar Chair				MODEL	LIST PRICE
Wood seat, wood back				CPBWW	\$996
W 19	D 20	H 43	SH 29.5	Optional Glides: Add \$8.00 net per chair for a set of four (4). Optional Glides raise chair height .5 inch.	

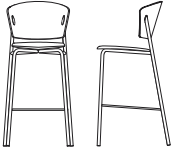

Café Parfait Bar Chair				MODEL	LIST PRICE/GRADE	COM/COL	A	B	C	D	E	F	G	H	I	J	K	L	
3D Beech veneer shell, upholstered seat onlay				CPBUW	\$949		981	999	1017	1035	1053	1071	1089	1107	1125	1143	1161	1179	
				Optional Glides: Add \$8.00 net per chair for a set of four (4). Optional Glides raise chair height .5 inch.															
				COM Yardage: 1 or 2 seats: .75 yard; 3 or 4 seats: 1.25 yards															
W 19 D 20 H 43 SH 30				Contact Leland Customer Experience for yardage requirements on textiles with repeats.															
				For COL requirements please contact Leland Customer Experience.															

To specify:
 Please refer to pages 3-4 for complete specifying information.
 Specify all products by their product code.

Pricing Effective: January 2025

CAFÉ PARFAIT TRANSPORT/STACKING DOLLY
Design: Leland Design Group

CP8

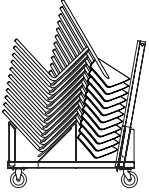

**Café Parfait Transport/
Stacking Dolly**

			MODEL	LIST PRICE
W 19	D 43	H 45 (Empty)	CPD	\$1121
W 19	D 43	H 67	Café Parfait Transport/Stacking Dolly handles up to 10 Café Parfait side chairs.	

(With 10 side chairs)

To specify:

Please refer to pages 3-4 for complete specifying information. Specify all products by their product code.

Pricing Effective: January 2025

**5695 Eagle Drive, SE
Grand Rapids,
Michigan 49512
616-975-9260
lelandfurniture.com**

Cambre Table

January 2025 Price List

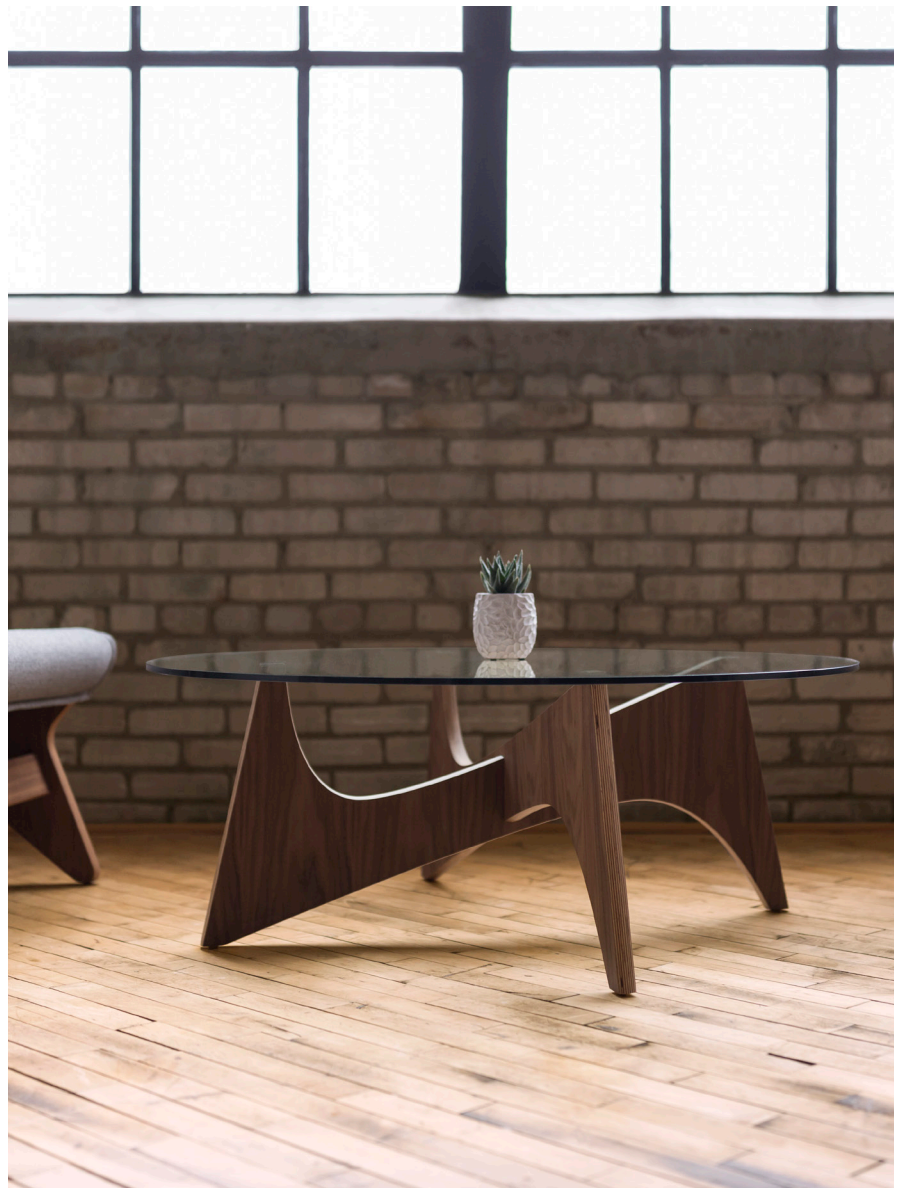

Cambre Table

Table of Contents	CA2
Specification Information	CA3
Specification Example	CA4
Table 16"	CA5
Table 22"	CA5

Table Model

DESCRIPTION	CODE
Cambre Table	CA

Table Height

DESCRIPTION	CODE
16"	16H
22"	22H

Base Finish

DESCRRIPTION	CODE
Natural Walnut	08M
Natural Ash	07M

Maple in Standard Leland Colors

LELAND COLORS

Top Size

DESCRRIPTION	CODE
16" H Table	
42" Round	42D
34" Square	3434
22" H Table	
18" Round	18D
16" Square	1616

Top Surface Option

DESCRRIPTION	CODE
16" H Table	
Clear Glass	G
22" H Table	
Clear Glass	G

Glide Selection

DESCRRIPTION	CODE
Nylon (standard)	S
Felt	F

Specifications required to create the product code

- Model
- Table Height
- Base Finish Selection
- Top Size
- Top Surface
- Glide Selection

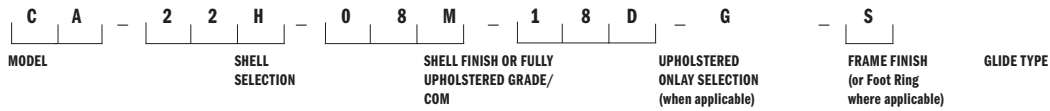

MODEL

Cambre Table (CA)

TABLE HEIGHT

22" (22H)

BASE FINISH

Natural Walnut (08M)

TOP SIZE

18" Round (18D)

TOP SURFACE

Glass (G)

GLIDE SELECTION

Nylon (S)



CAMBRE TABLE
Design: Bruce Sienkowski

CA5

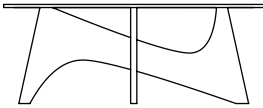

Cambre	MODEL	CLEAR GLASS
Cambre Occasional Table, 42" Round Top W 42 D 42 H 16	CA-16H-42D	\$2422
Optional Glides: Add \$8.00 net per chair for a set of four (4).		

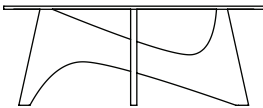

Cambre	MODEL	CLEAR GLASS
Cambre Occasional Table, 34" Square Top W 34 D 34 H 16	CA-16H-3434	\$1915
Optional Glides: Add \$8.00 net per chair for a set of four (4).		

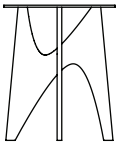

Cambre	MODEL	CLEAR GLASS
Cambre Side Table, 18" Round Top W 18 D 18 H 22	CA-22H-18D	\$1930
Optional Glides: Add \$8.00 net per chair for a set of four (4).		

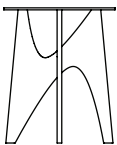

Cambre	MODEL	CLEAR GLASS
Cambre Side Table, 16" Square Top W 16 D 16 H 22	CA-22H-1616	\$1521
Optional Glides: Add \$8.00 net per chair for a set of four (4).		

To specify:
Please refer to pages 3-4 for complete specifying information. Specify all products by their product code.

5695 Eagle Drive, SE
Grand Rapids,
Michigan 49512
616-975-9260
lelandfurniture.com

Driftwood Table

January 2025 Price List



Driftwood

Table of Contents	DWT2
Squirrel Base Visual Reference	DWT3
Circle and Soft Rectangle Base Visual Reference	DWT4
Tandem Base Conference Table Visual Reference	DWT5
Specification Information	DWT6
Specification Example	DWT7
Small Base, Powder Coat Column	DWT8
Small Base, Oak Column	DWT9
Small Base, Walnut Column	DWT10
Small Base, Maple Column	DWT11
Medium Base, Powder Coat Column	DWT12
Medium Base, Oak Column	DWT13
Medium Base, Walnut Column	DWT14
Medium Base, Maple Column	DWT15
Large Base, Powder Coat Column	DWT16
Large Base, Oak Column	DWT17
Large Base, Walnut Column	DWT18
Large Base, Maple Column	DWT19
Small Rectangle Base, Powder Coat Column	DWT20
Small Rectangle Base, Oak Column	DWT21
Small Rectangle Base, Walnut Column	DWT22
Small Rectangle Base, Maple Column	DWT23
Tandem Base, Powder Coat Column, Counter Height	DWT24
Tandem Base, Oak Column, Counter Height	DWT25

2024 DRIFTWOOD TABLE PRICELIST

Tandem Base, Walnut Column, Counter Height	DWT26
Tandem Base, Maple Column, Counter Height	DWT27
Tandem Base, Powder Coat Column, Bar Height	DWT28
Tandem Base, Oak Column, Bar Height	DWT29
Tandem Base, Walnut Column, Bar Height	DWT30
Tandem Base, Maple Column, Bar Height	DWT31
Four Leg - Powder Coat, Counter Height	DWT32
Four Leg - Oak, Counter Height	DWT33
Four Leg - Walnut, Counter Height	DWT34
Four Leg - Maple, Counter Height	DWT35

TABLE MODEL	TABLE HEIGHT	BASE	PAGE
Small Squircle Base	26 29 36 42	Powder Coat	
			
30 x 30			

TABLE MODEL	TABLE HEIGHT	BASE	PAGE
Medium Squircle Base	26 29 36 42	Powder Coat	
			
36 x 36			

TABLE MODEL	TABLE HEIGHT	BASE	PAGE
Large Squircle Base	26 29 36 42	Powder Coat	
			
42 x 42			

TABLE MODEL	TABLE HEIGHT	BASE SIZE	PAGE
Small Circle Base	26	Powder Coat	
 30 Dia	29		
	36		
	42		

TABLE MODEL	TABLE HEIGHT	BASE SIZE	PAGE
Medium Circle Base	26	Powder Coat	
 36 Dia	29		
	36		
	42		

TABLE MODEL	TABLE HEIGHT	BASE SIZE	PAGE
Large Circle Base	26	Powder Coat	
 42 Dia	29		
	36		
	42		

TABLE MODEL	TABLE HEIGHT	BASE	PAGE
Small Rectangle Base	26	Powder Coat	
 24 x 36	29		
	36		
	42		

TABLE MODEL	TABLE TOP SIZE	BASE	PAGE
Conference Table Tandem Base 	60 x 36	Powder Coat	
	72 x 36		
	84 x 42		
	96 x 42		

Table Model

DESCRIPTION	CODE
Driftwood pedestal table, small squircle base	DWSS
Driftwood pedestal table, medium squircle base	DWMS
Driftwood pedestal table, large squircle base	DWLS
Driftwood pedestal table, small circle base	DWSC
Driftwood pedestal table, medium circle base	DWMC
Driftwood pedestal table, large circle base	DWLC
Driftwood pedestal table, small rectangle base	DWSR
Driftwood pedestal table, tandem base	DWT
Driftwood 4 leg table	DW4

TABLE HEIGHTS:

DESCRIPTION	CODE
26"	26H
29"	29H
36"	36H
42"	42H

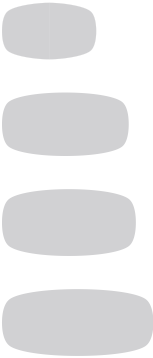
COLUMN TYPE:

DESCRIPTION	CODE
Oak	O
Walnut	W
Maple	M
Aluminum	A

Top Sizes

ROUND	CODE	SOFT SQUARE	CODE	SOFT RECTANGLE	CODE
30 DIA	30D	30x30	3030	24x36	2436
36 DIA	36D	36x36	3636		
42 DIA	42D	42x42	4242		

Aluminum Column & Base Plate Finish: Powder Coat

DESCRIPTION	CODE	DESCRIPTION	CODE
White Textured	WT	Matte Blue Sky	MBS
Black Textured	BT	Matte Forest	MFO
Sterling	ST	Matte Sienna	MSN
Dolphin Textured	DLT	Matte Willow	MWL
Oxford Textured	OXT	Matte Fawn	MFN
Mercury Textured	MRT	Matte Fog	MFG
Mineral Textured	MNT	Matte Pine	MPN
Burnish Textured	BNT	Matte Pistachio	MPS
Foundry Textured	FNT		

Wood Top & Column Finish

OAK :

DESCRIPTION
Leland Oak Colors [\(Click Here to View\)](#)

WALUNT:

DESCRIPTION	CODE
Natural Walnut	08M

MAPLE:

DESCRIPTION
Leland Maple Colors [\(Click Here to View\)](#)

CUSTOM SPECIFY custom (01)

*Please note that Driftwood Table wood tops & columns are NOT AVAILABLE in the following finishes: Natural Ash (07M) & Natural Beech (09M)

LAMINATE TOPS:

DESCRIPTION	CODE
Grey Laminate - Platinum Wilsonart®	LGY
Black Laminate - Black Pionite®	LBK
White Laminate - Designer White Wilsonart®	LWH

Please refer to the Leland Terms and Conditions Guide for a listing of standard laminates. For table pricing in laminates not listed, please contact Leland's Customer Experience Department for a quotation.

Edge Type

VINYL EDGES:

DESCRIPTION	CODE
1 ^{3/16"} flat PVC	V6

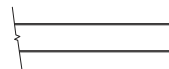

WOOD EDGES:

DESCRIPTION	CODE
1" rolled beveled plywood	W8



Edge Finish or Color

VINYL EDGE COLORS:

DESCRIPTION	CODE
Black	B
White	W
Grey	G

WOOD EDGE COLORS:

STANDARD LELAND COLORS [\(Click here to view\)](#)

CUSTOM SPECIFY Custom (01)

CUSTOM SPECIFY Custom (01)

Specifications required to create the product code

- Model
- Table Height
- Top Size
- Column Finish
- Base Plate Finish
- Top Finish
- Edge Type
- AUX (when applicable)

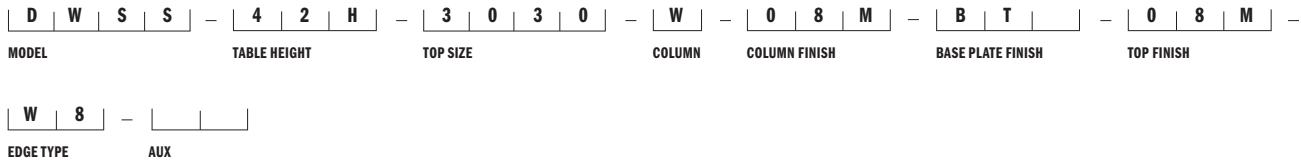

MODEL

Driftwood Bar Height Table,
Small Squirle Base (DWSS)

TOP SIZE

3030

TOP FINISH

08M

TABLE HEIGHT

42H

COLUMN

W

COLUMN FINISH

08M

EDGE TYPE (AND COLOR IF APPLICABLE)

W8

BASE PLATE (AND COLOR IF APPLICABLE)

BT



DRIFTWOOD PEDESTAL TABLE, SMALL BASE
 Design: Nao Tamura

DWT8



**Driftwood Table,
 Powder Coat Column**

	MODEL	TABLE HEIGHT/CODE	LIST PRICE/EDGE CODES:	V6	W8
 30 x 30	DWSS	Wood Top			
		26H		\$2023	2602
		29H		\$2058	2637
		36H		\$2132	2709
		42H		\$2201	2780
		Laminate Top			
		26H		\$1782	2267
		29H		\$1817	2302
		36H		\$1897	2382
		42H		\$1961	2446



**Driftwood Table,
 Powder Coat Column**

	MODEL	TABLE HEIGHT/CODE	LIST PRICE/EDGE CODES:	V6	W8
 30 Dia.	DWSC	Wood Top			
		26H		\$2023	2602
		29H		\$2058	2637
		36H		\$2132	2709
		42H		\$2201	2780
		Laminate Top			
		26H		\$1782	2267
		29H		\$1817	2302
		36H		\$1897	2382
		42H		\$1961	2446

To specify:
 Please refer to pages 6-8 for complete specifying information.
 Specify all products by their product code.

DRIFTWOOD PEDESTAL TABLE, SMALL BASE
 Design: Nao Tamura

DWT9



**Driftwood Table,
 Oak Column**

	MODEL	TABLE HEIGHT/CODE	LIST PRICE/EDGE CODES:	V6	W8
Small Squire Base  30 x 30	DWSS	Wood Top			
		26H		\$2857	3436
		29H		\$2892	3471
		36H		\$2966	3543
		42H		\$3035	3614
		Laminate Top			
		26H		\$2616	3101
		29H		\$2651	3136
		36H		\$2731	3216
		42H		\$2795	3280



**Driftwood Table,
 Oak Column**

	MODEL	TABLE HEIGHT/CODE	LIST PRICE/EDGE CODES:	V6	W8
Small Circle Base  30 Dia.	DWSS	Wood Top			
		26H		\$2857	3436
		29H		\$2892	3471
		36H		\$2966	3543
		42H		\$3035	3614
		Laminate Top			
		26H		\$2616	3101
		29H		\$2651	3136
		36H		\$2731	3216
		42H		\$2795	3280

To specify:
 Please refer to pages 6-8 for complete specifying information.
 Specify all products by their product code.

DRIFTWOOD PEDESTAL TABLE, SMALL BASE
 Design: Nao Tamura

DWT10

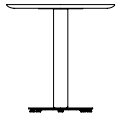

**Driftwood Table,
Walnut Column**

	MODEL	TABLE HEIGHT/CODE	LIST PRICE/EDGE CODES:	V6	W8
Small Squire Base  30 x 30	DWSS	Wood Top			
		26H		\$2947	3526
		29H		\$2982	3561
		36H		\$3056	3633
		42H		\$3125	3704
		Laminate Top			
		26H		\$2706	3191
		29H		\$2741	3226
		36H		\$2821	3306
		42H		\$2885	3370



**Driftwood Table,
Walnut Column**

	MODEL	TABLE HEIGHT/CODE	LIST PRICE/EDGE CODES:	V6	W8
Small Circle Base  30 Dia.	DWSS	Wood Top			
		26H		\$2947	3526
		29H		\$2982	3561
		36H		\$3056	3633
		42H		\$3125	3704
		Laminate Top			
		26H		\$2706	3191
		29H		\$2741	3226
		36H		\$2821	3306
		42H		\$2885	3370

To specify:
 Please refer to pages 6-8 for complete specifying information.
 Specify all products by their product code.

Pricing Effective: January 2025

DRIFTWOOD PEDESTAL TABLE, SMALL BASE
 Design: Nao Tamura

DWT11



**Driftwood Table,
 Maple Column**

	MODEL	TABLE HEIGHT/CODE	LIST PRICE/EDGE CODES:	V6	W8
Small Squire Base  30 x 30	DWSS	Wood Top			
		26H		\$2373	2952
		29H		\$2408	2987
		36H		\$2482	3059
		42H		\$2551	3130
		Laminate Top			
		26H		\$2132	2617
		29H		\$2167	2652
		36H		\$2247	2732
		42H		\$2311	2796



**Driftwood Table,
 Maple Column**

	MODEL	TABLE HEIGHT/CODE	LIST PRICE/EDGE CODES:	V6	W8
Small Circle Base  30 Dia.	DWSS	Wood Top			
		26H		\$2373	2952
		29H		\$2408	2987
		36H		\$2482	3059
		42H		\$2551	3130
		Laminate Top			
		26H		\$2132	2617
		29H		\$2167	2652
		36H		\$2247	2732
		42H		\$2311	2796

To specify:
 Please refer to pages 6-8 for complete specifying information.
 Specify all products by their product code.

DRIFTWOOD PEDESTAL TABLE, MEDIUM BASE
 Design: Nao Tamura

DWT12



**Driftwood Table,
 Powder Coat Column**

	MODEL	TABLE HEIGHT/CODE	LIST PRICE/EDGE CODES:	V6	W8
 36 x 36	DWMS	Wood Top			
		26H		\$2137	2714
		29H		\$2172	2749
		36H		\$2246	2823
		42H		\$2315	2892
		Laminate Top			
		26H		\$1879	2364
		29H		\$1914	2399
		36H		\$1988	2473
		42H		\$2057	2542



**Driftwood Table,
 Powder Coat Column**

	MODEL	TABLE HEIGHT/CODE	LIST PRICE/EDGE CODES:	V6	W8
 36"	DWMC	Wood Top			
		26H		\$2137	2714
		29H		\$2172	2749
		36H		\$2246	2823
		42H		\$2315	2892
		Laminate Top			
		26H		\$1879	2364
		29H		\$1914	2399
		36H		\$1988	2473
		42H		\$2057	2542

To specify:
 Please refer to pages 6-8 for complete specifying information.
 Specify all products by their product code.

Pricing Effective: January 2025

DRIFTWOOD PEDESTAL TABLE, MEDIUM BASE
 Design: Nao Tamura

DWT13

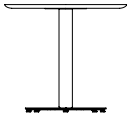

**Driftwood Table,
 Oak Column**

	MODEL	TABLE HEIGHT/CODE	LIST PRICE/EDGE CODES:	V6	W8
 36 x 36	DWMS	Wood Top			
		26H		\$2971	3548
		29H		\$3006	3583
		36H		\$3080	3657
		42H		\$3149	3726
		Laminate Top			
		26H		\$2713	3198
		29H		\$2748	3233
		36H		\$2822	3307
		42H		\$2891	3376



**Driftwood Table,
 Oak Column**

	MODEL	TABLE HEIGHT/CODE	LIST PRICE/EDGE CODES:	V6	W8
 36"	DWMC	Wood Top			
		26H		\$2971	3548
		29H		\$3006	3583
		36H		\$3080	3657
		42H		\$3149	3726
		Laminate Top			
		26H		\$2713	3198
		29H		\$2748	3233
		36H		\$2822	3307
		42H		\$2891	3376

To specify:
 Please refer to pages 6-8 for complete specifying information.
 Specify all products by their product code.

Pricing Effective: January 2025

DRIFTWOOD PEDESTAL TABLE, MEDIUM BASE
 Design: Nao Tamura

DWT14



**Driftwood Table,
Walnut Column**

	MODEL	TABLE HEIGHT/CODE	LIST PRICE/EDGE CODES:	V6	W8
 36 x 36	DWMS	Wood Top			
		26H		\$3061	3638
		29H		\$3096	3673
		36H		\$3170	3747
		42H		\$3239	3816
		Laminate Top			
		26H		\$2803	3288
		29H		\$2838	3323
		36H		\$2912	3397
		42H		\$2981	3466



**Driftwood Table,
Walnut Column**

	MODEL	TABLE HEIGHT/CODE	LIST PRICE/EDGE CODES:	V6	W8
 36"	DWMC	Wood Top			
		26H		\$3061	3638
		29H		\$3096	3673
		36H		\$3170	3747
		42H		\$3239	3816
		Laminate Top			
		26H		\$2803	3288
		29H		\$2838	3323
		36H		\$2912	3397
		42H		\$2981	3466

To specify:
 Please refer to pages 6-8 for complete specifying information.
 Specify all products by their product code.

Pricing Effective: January 2025

DRIFTWOOD PEDESTAL TABLE, MEDIUM BASE
 Design: Nao Tamura

DWT15

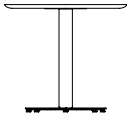

**Driftwood Table,
 Maple Column**

	MODEL	TABLE HEIGHT/CODE	LIST PRICE/EDGE CODES:	V6	W8
 36 x 36	DWMS	Wood Top			
		26H		\$2487	3064
		29H		\$2522	3099
		36H		\$2596	3173
		42H		\$2665	3242
		Laminate Top			
		26H		\$2229	2714
		29H		\$2264	2749
		36H		\$2338	2823
		42H		\$2407	2892



**Driftwood Table,
 Maple Column**

	MODEL	TABLE HEIGHT/CODE	LIST PRICE/EDGE CODES:	V6	W8
 36"	DWMC	Wood Top			
		26H		\$2487	3064
		29H		\$2522	3099
		36H		\$2596	3173
		42H		\$2665	3242
		Laminate Top			
		26H		\$2229	2714
		29H		\$2264	2749
		36H		\$2338	2823
		42H		\$2407	2892

To specify:
 Please refer to pages 6-8 for complete specifying information.
 Specify all products by their product code.

Pricing Effective: January 2025

DRIFTWOOD PEDESTAL TABLE, LARGE BASE
 Design: Nao Tamura

DWT16

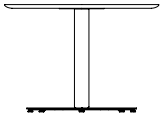

**Driftwood Table,
 Powder Coat Column**

Large Square Base

MODEL

DWLS

TABLE HEIGHT/CODE

LIST PRICE/EDGE CODES:

V6

W8

Wood Top

26H

\$2940

3518

29H

\$2975

3553

36H

\$3049

3627

42H

\$3118

3696

Laminate Top

26H

\$2561

3045

29H

\$2596

3080

36H

\$2670

3154

42H

\$2739

3223



42 x 42

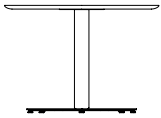

**Driftwood Table,
 Powder Coat Column**

Large Circle Base

MODEL

DWLC

TABLE HEIGHT/CODE

LIST PRICE/EDGE CODES:

V6

W8

Wood Top

26H

\$2940

3518

29H

\$2975

3553

36H

\$3049

3627

42H

\$3118

3696

Laminate Top

26H

\$2561

3045

29H

\$2596

3080

36H

\$2670

3154

42H

\$2739

3223



42"

To specify:
 Please refer to pages 6-8 for complete specifying information.
 Specify all products by their product code.

Pricing Effective: January 2025

DRIFTWOOD PEDESTAL TABLE, LARGE BASE
 Design: Nao Tamura

DWT17

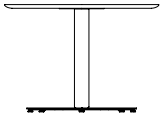

**Driftwood Table,
 Oak Column**

	MODEL	TABLE HEIGHT/CODE	LIST PRICE/EDGE CODES:	V6	W8
Large Squircle Base  42 x 42	DWLS	Wood Top			
		26H		\$3774	4352
		29H		\$3809	4387
		36H		\$3883	4461
		42H		\$3952	4530
		Laminate Top			
		26H		\$3395	3879
		29H		\$3430	3914
		36H		\$3504	3988
		42H		\$3573	4057

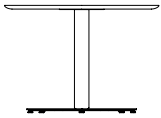

**Driftwood Table,
 Oak Column**

	MODEL	TABLE HEIGHT/CODE	LIST PRICE/EDGE CODES:	V6	W8
Large Circle Base  42"	DWLC	Wood Top			
		26H		\$3774	4352
		29H		\$3809	4387
		36H		\$3883	4461
		42H		\$3952	4530
		Laminate Top			
		26H		\$3395	3879
		29H		\$3430	3914
		36H		\$3504	3988
		42H		\$3573	4057

To specify:
 Please refer to pages 6-8 for complete specifying information.
 Specify all products by their product code.

Pricing Effective: January 2025

DRIFTWOOD PEDESTAL TABLE, LARGE BASE
 Design: Nao Tamura

DWT18

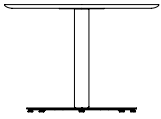

**Driftwood Table,
Walnut Column**

Large Square Base

MODEL
DWLS

TABLE HEIGHT/CODE

LIST PRICE/EDGE CODES:

V6

W8

TABLE HEIGHT/CODE	LIST PRICE/EDGE CODES:	V6	W8
Wood Top			
26H		\$3864	4442
29H		\$3899	4477
36H		\$3973	4551
42H		\$4042	4620
Laminate Top			
26H		\$3485	3969
29H		\$3520	4004
36H		\$3594	4078
42H		\$3663	4147



42 x 42

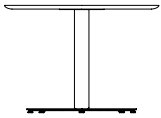

**Driftwood Table,
Walnut Column**

Large Circle Base

MODEL
DWLC

TABLE HEIGHT/CODE

LIST PRICE/EDGE CODES:

V6

W8

TABLE HEIGHT/CODE	LIST PRICE/EDGE CODES:	V6	W8
Wood Top			
26H		\$3864	4442
29H		\$3899	4477
36H		\$3973	4551
42H		\$4042	4620
Laminate Top			
26H		\$3485	3969
29H		\$3520	4004
36H		\$3594	4078
42H		\$3663	4147



42"

To specify:
 Please refer to pages 6-8 for complete specifying information.
 Specify all products by their product code.

Pricing Effective: January 2025

DRIFTWOOD PEDESTAL TABLE, LARGE BASE
 Design: Nao Tamura

DWT19

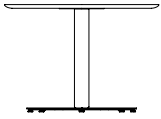

**Driftwood Table,
 Maple Column**

	MODEL	TABLE HEIGHT/CODE	LIST PRICE/EDGE CODES:	V6	W8
Large Squirecle Base  42 x 42	DWLS	Wood Top			
		26H		\$3290	3868
		29H		\$3325	3903
		36H		\$3399	3977
		42H		\$3468	4046
		Laminate Top			
		26H		\$2911	3395
		29H		\$2946	3430
		36H		\$3020	3504
		42H		\$3089	3573

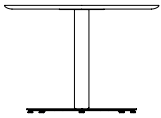

**Driftwood Table,
 Maple Column**

	MODEL	TABLE HEIGHT/CODE	LIST PRICE/EDGE CODES:	V6	W8
Large Circle Base  42"	DWLC	Wood Top			
		26H		\$3290	3868
		29H		\$3325	3903
		36H		\$3399	3977
		42H		\$3468	4046
		Laminate Top			
		26H		\$2911	3395
		29H		\$2946	3430
		36H		\$3020	3504
		42H		\$3089	3573

To specify:
 Please refer to pages 6-8 for complete specifying information.
 Specify all products by their product code.

Pricing Effective: January 2025

DRIFTWOOD PEDESTAL TABLE, SMALL RECTANGLE BASE
 Design: Nao Tamura

DWT20

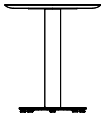

**Driftwood Table,
 Powder Coat Column**

	MODEL	TABLE HEIGHT/CODE	LIST PRICE/EDGE CODES:	V6	W8
Small Rectangular Base	DWSR	Wood Top			
		26H		\$1841	2314
		29H		\$1876	2349
		36H		\$1950	2423
		42H		\$2019	2492
		Laminate Top			
		26H		\$1627	2023
		29H		\$1662	2058
		36H		\$1736	2132
		42H		\$1805	2201



24 x 36

To specify:
 Please refer to pages 6-8 for complete specifying information.
 Specify all products by their product code.

DRIFTWOOD PEDESTAL TABLE, SMALL RECTANGLE BASE
 Design: Nao Tamura

DWT21

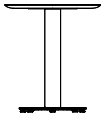

**Driftwood Table,
 Oak Column**

	MODEL	TABLE HEIGHT/CODE	LIST PRICE/EDGE CODES:	V6	W8
Small Rectangular Base	DWSR	Wood Top			
		26H		\$2675	3148
		29H		\$2710	3183
		36H		\$2784	3257
		42H		\$2853	3326
		Laminate Top			
		26H		\$2461	2857
		29H		\$2496	2892
		36H		\$2570	2966
		42H		\$2639	3035



24 x 36

To specify:
 Please refer to pages 6-8 for complete specifying information.
 Specify all products by their product code.

Pricing Effective: January 2025

DRIFTWOOD PEDESTAL TABLE, SMALL RECTANGLE BASE
 Design: Nao Tamura

DWT22

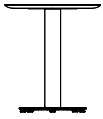

**Driftwood Table,
Walnut Column**

Small Rectangular Base

MODEL
DWSR

TABLE HEIGHT/CODE

LIST PRICE/EDGE CODES:

V6

W8



24 x 36

Wood Top

26H	\$2765	3238
-----	--------	------

29H	\$2800	3273
-----	--------	------

36H	\$2874	3347
-----	--------	------

42H	\$2943	3416
-----	--------	------

Laminate Top

26H	\$2551	2947
-----	--------	------

29H	\$2586	2982
-----	--------	------

36H	\$2660	3056
-----	--------	------

42H	\$2729	3125
-----	--------	------

To specify:

Please refer to pages 6-8 for complete specifying information.

Specify all products by their product code.

Pricing Effective: January 2025

DRIFTWOOD PEDESTAL TABLE, SMALL RECTANGLE BASE
 Design: Nao Tamura

DWT23

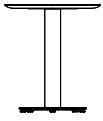

**Driftwood Table,
 Maple Column**

Small Rectangular Base

MODEL
 DWSR

TABLE HEIGHT/CODE

LIST PRICE/EDGE CODES:

V6

W8



24 x 36

Wood Top

26H	\$2191	2664
-----	--------	------

29H	\$2226	2699
-----	--------	------

36H	\$2300	2773
-----	--------	------

42H	\$2369	2842
-----	--------	------

Laminate Top

26H	\$1977	2373
-----	--------	------

29H	\$2012	2408
-----	--------	------

36H	\$2086	2482
-----	--------	------

42H	\$2155	2551
-----	--------	------

To specify:

Please refer to pages 6-8 for complete specifying information.

Specify all products by their product code.

Pricing Effective: January 2025





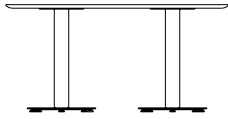



DRIFTWOOD CONFERENCE TABLE, TANDEM BASE
 Design: Nao Tamura

DWT24



Driftwood Table,

Tandem Powder Coat Column

MODEL	TABLE HEIGHT/CODE	LIST PRICE/EDGE CODES:	V6	W8
Squire Base	Wood Top			
				
Table Height 29	60 x 36		\$3596	4579
				
	72 x 36		\$3693	4674
				
	84 x 42		\$5058	6041
				
	96 x 42		\$5311	6344
	Laminate Top			
				
	60 x 36		\$3172	3996
				
	72 x 36		\$3254	4079
				
	84 x 42		\$4414	5236
				
	96 x 42		\$4635	5498







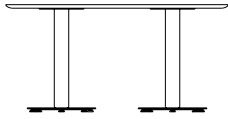

To specify:
 Please refer to pages 6-8 for complete specifying information.
 Specify all products by their product code.

DRIFTWOOD CONFERENCE TABLE, TANDEM BASE
 Design: Nao Tamura

DWT25



**Driftwood Table,
 Tandem Oak Column**

	MODEL	TABLE HEIGHT/CODE	LIST PRICE/EDGE CODES:	V6	W8
Squire Base	DWT	Wood Top			
Table Height 29					
		60 x 36		\$5264	6247
					
		72 x 36		\$5361	6342
					
		84 x 42		\$6726	7709
					
		96 x 42		\$7735	8866
		Laminate Top			
					
		60 x 36		\$4840	5664
					
		72 x 36		\$4922	5747
					
		84 x 42		\$6082	6904
					
		96 x 42		\$6994	7940







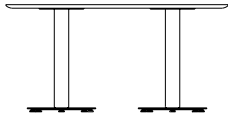

To specify:
 Please refer to pages 6-8 for complete specifying information.
 Specify all products by their product code.

DRIFTWOOD CONFERENCE TABLE, TANDEM BASE
 Design: Nao Tamura

DWT26



**Driftwood Table,
 Tandem Walnut Column**

	MODEL	TABLE HEIGHT/CODE	LIST PRICE/EDGE CODES:	V6	W8
Squire Base	DWT	Wood Top			
Table Height 29					
		60 x 36		\$5444	6427
					
		72 x 36		\$5541	6522
					
		84 x 42		\$6906	7889
					
		96 x 42		\$7942	9073
		Laminate Top			
					
		60 x 36		\$5020	5844
					
		72 x 36		\$5102	5927
					
		84 x 42		\$6262	7084
					
		96 x 42		\$7201	8147



To specify:
 Please refer to pages 6-8 for complete specifying information.
 Specify all products by their product code.

DRIFTWOOD CONFERENCE TABLE, TANDEM BASE
 Design: Nao Tamura

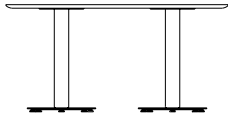
DWT27



**Driftwood Table,
 Tandem Maple Column**

	MODEL	TABLE HEIGHT/CODE	LIST PRICE/EDGE CODES:	V6	W8
Squire Base	DWT	Wood Top			
Table Height 29					
		60 x 36		\$4296	5279
					
		72 x 36		\$4393	5374
					
		84 x 42		\$5758	6741
					
		96 x 42		\$6622	7753
		Laminate Top			
					
		60 x 36		\$3872	4696
					
		72 x 36		\$3954	4779
					
		84 x 42		\$5114	5936
					
		96 x 42		\$5881	6827

To specify:
 Please refer to pages 6-8 for complete specifying information.
 Specify all products by their product code.





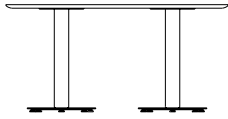



DRIFTWOOD CONFERENCE TABLE, TANDEM BASE
 Design: Nao Tamura

DWT28



Driftwood Table,

Tandem Powder Coat Column

MODEL	TABLE HEIGHT/CODE	LIST PRICE/EDGE CODES:	V6	W8
Squire Base	Wood Top			
DWT				
Table Height 42				
	60 x 36		\$3839	4822
				
	72 x 36		\$3936	4917
				
	84 x 42		\$5301	6284
				
	96 x 42		\$5566	6599
	Laminate Top			
				
	60 x 36		\$3839	3996
				
	72 x 36		\$3936	4917
				
	84 x 42		\$5301	6284
				
	96 x 42		\$5566	6599







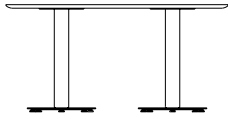

To specify:
 Please refer to pages 6-8 for complete specifying information.
 Specify all products by their product code.

DRIFTWOOD CONFERENCE TABLE, TANDEM BASE
 Design: Nao Tamura

DWT29



**Driftwood Table,
 Tandem Oak Column**

	MODEL	TABLE HEIGHT/CODE	LIST PRICE/EDGE CODES:	V6	W8
Squire Base	DWT	Wood Top			
Table Height 42					
		60 x 36		\$5507	6490
					
		72 x 36		\$5604	6585
					
		84 x 42		\$6969	7952
					
		96 x 42		\$8014	9145
		Laminate Top			
					
		60 x 36		\$5507	5664
					
		72 x 36		\$5604	6585
					
		84 x 42		\$6969	7952
					
		96 x 42		\$8014	9145



To specify:
 Please refer to pages 6-8 for complete specifying information.
 Specify all products by their product code.

DRIFTWOOD CONFERENCE TABLE, TANDEM BASE
 Design: Nao Tamura

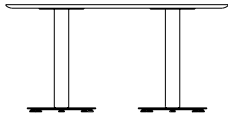
DWT30



**Driftwood Table,
 Tandem Walnut Column**

	MODEL	TABLE HEIGHT/CODE	LIST PRICE/EDGE CODES:	V6	W8
Squire Base	DWT	Wood Top			
Table Height 42					
		60 x 36		\$5687	6670
					
		72 x 36		\$5784	6765
					
		84 x 42		\$7149	8132
					
		96 x 42		\$8221	9352
		Laminate Top			
					
		60 x 36		\$5687	5844
					
		72 x 36		\$5784	6765
					
		84 x 42		\$7149	8132
					
		96 x 42		\$8221	9352



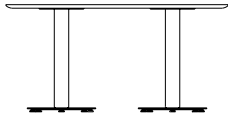

To specify:
 Please refer to pages 6-8 for complete specifying information.
 Specify all products by their product code.

DRIFTWOOD CONFERENCE TABLE, TANDEM BASE
 Design: Nao Tamura

DWT31

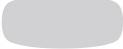

**Driftwood Table,
 Tandem Maple Column**

	MODEL	TABLE HEIGHT/CODE	LIST PRICE/EDGE CODES:	V6	W8
Squire Base	DWT	Wood Top			
Table Height 42					
		60 x 36		\$4539	5522
					
		72 x 36		\$4636	5617
					
		84 x 42		\$6001	6984
					
		96 x 42		\$6901	8032
		Laminate Top			
					
		60 x 36		\$4539	4696
					
		72 x 36		\$4636	5617
					
		84 x 42		\$6001	6984
					
		96 x 42		\$6901	8032



To specify:
 Please refer to pages 6-8 for complete specifying information.
 Specify all products by their product code.

DRIFTWOOD CONFERENCE TABLE, FOUR LEG
 Design: Nao Tamura

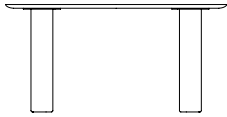
DWT32



**Driftwood Table,
 Four Leg - Powder Coat**

	MODEL	TABLE HEIGHT/CODE	LIST PRICE/EDGE CODES:	V6	W8
Squire Base	DW4	Wood Top			
Table Height 29					
		60 x 36		\$3839	4822
					
		72 x 36		\$3936	4917
					
		84 x 42		\$5301	6284
					
		96 x 42		\$5566	6599
		Laminate Top			
					
		60 x 36		\$3839	3996
					
		72 x 36		\$3936	4917
					
		84 x 42		\$5301	6284
					
		96 x 42		\$5566	6599







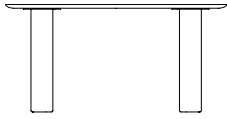

To specify:
 Please refer to pages 6-8 for complete specifying information.
 Specify all products by their product code.

DRIFTWOOD CONFERENCE TABLE, FOUR LEG
 Design: Nao Tamura

DWT33



**Driftwood Table,
 Four Leg - Oak**

	MODEL	TABLE HEIGHT/CODE	LIST PRICE/EDGE CODES:	V6	W8
Squire Base	DW4	Wood Top			
Table Height 29					
		60 x 36		\$5507	6490
					
		72 x 36		\$5604	6585
					
		84 x 42		\$6969	7952
					
		96 x 42		\$8014	9145
		Laminate Top			
					
		60 x 36		\$5507	5664
					
		72 x 36		\$5604	6585
					
		84 x 42		\$6969	7952
					
		96 x 42		\$8014	9145







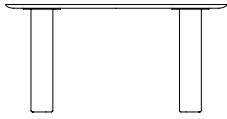

To specify:
 Please refer to pages 6-8 for complete specifying information.
 Specify all products by their product code.

DRIFTWOOD CONFERENCE TABLE, FOUR LEG
 Design: Nao Tamura

DWT34



**Driftwood Table,
 Four Leg - Walnut**

	MODEL	TABLE HEIGHT/CODE	LIST PRICE/EDGE CODES:	V6	W8
Squircle Base	DW4	Wood Top			
Table Height 29					
		60 x 36		\$5687	6670
					
		72 x 36		\$5784	6765
					
		84 x 42		\$7149	8132
					
		96 x 42		\$8221	9352
		Laminate Top			
					
		60 x 36		\$5687	5844
					
		72 x 36		\$5784	6765
					
		84 x 42		\$7149	8132
					
		96 x 42		\$8221	9352







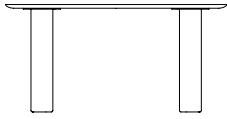

To specify:
 Please refer to pages 6-8 for complete specifying information.
 Specify all products by their product code.

DRIFTWOOD CONFERENCE TABLE, FOUR LEG
 Design: Nao Tamura

DWT35



**Driftwood Table,
 Four Leg - Maple**

	MODEL	TABLE HEIGHT/CODE	LIST PRICE/EDGE CODES:	V6	W8
Squire Base	DW4	Wood Top			
Table Height 29					
		60 x 36		\$4539	5522
					
		72 x 36		\$4636	5617
					
		84 x 42		\$6001	6984
					
		96 x 42		\$6901	8032
		Laminate Top			
					
		60 x 36		\$4539	4696
					
		72 x 36		\$4636	5617
					
		84 x 42		\$6001	6984
					
		96 x 42		\$6901	8032

To specify:
 Please refer to pages 6-8 for complete specifying information.
 Specify all products by their product code.

**5695 Eagle Drive, SE
Grand Rapids,
Michigan 49512
616-975-9260
lelandfurniture.com**

Ease

January 2025 Price List



Ease

Table of Contents	ES2
Specification Information	ES3
Specification Example	ES4
Side Chair	ES5
Transport/Stacking Dolly	ES7

Chair Model

DESCRIPTION	CODE
Ease side chair, upholstered seat, wood back	ESSUW
Ease side chair ganging, upholstered seat , wood back	ESSGUW
Ease side chair, upholstered seat, wood back upholstered back onlay	ESSUWU
Ease side chair ganging, upholstered seat wood back, upholstered back onlay	ESSGUWU
Ease side chair, wood seat, wood back	ESSWW
Ease side chair ganging, wood seat wood back	ESSGWW

Seat and Back Wood Finish**STANDARD LELAND COLORS****CUSTOM** Specify Custom (01)

*Please note that Ease is NOT AVAILABLE in the following finishes:

Upholstery Selection

Please refer to Leland Textile Program which features textiles and leathers from the following partners:

- Camira
- Carnegie
- CF Stinson
- Green Hides
- Maharam
- Unika Vaev

The complete grade list can be found on our website or you can specify COM/COL. Due to the design of this product, it is recommended that all non pre-approved textile be tested for compatibility.

Frame Finish: Powdercoat and Chrome

DESCRIPTION	CODE
Sterling	ST
Warm Grey	WG
Cool Grey	CG
Black	B
White	W
Matte Mercury	MMR
Matte Mineral	MMN
Matte Burnish	MBN
Matte Foundry	MFN
Chrome	C
Matte Blue Sky	MBS
Matte Forest	MFO
Matte Sienna	MSN
Matte Willow	MWL
TEXTURED	CODE
Dolphin Textured	DLT
Oxford Textured	OXT
Black Textured	BT
White Textured	WT

Auxiliary Options**GLIDES**

DESCRIPTION	CODE
Polycarbonate	P
Felt	F

Please note that adding glides raises the chair height.25 inch.

Specifications required to create the product code

- Model
- Seat Upholstery or Finish
- Back Finish
- Upholstered Back Onlay (when applicable)
- Frame Finish
- Auxiliary Options (when applicable)



MODEL

Ease Side Chair, upholstered seat, wood back, upholstered back onlay (ESSUWU)

SEAT UPHOLSTERY OR FINISH

Grade H (H)

BACK FINISH

Natural (11)

UPHOLSTERED BACK ONLAY

Grade H (H)

FRAME FINISH

Chrome (C)



EASE SIDE CHAIR
Design: Leland Design Group

ES5



Ease Side Chair

	MODEL	LIST PRICE/GRADE	COM/COL	A	B	C	D	E	F	G	H	I	J	K	L
Upholstered seat, wood back	ESSUW		\$631	664	682	700	718	736	754	772	790	808	826	844	862

Glides: Add \$8.00 net per chair for a set of four (4).

W 19.5 D 21.75 H 31 SH 18.5

COM Yardage: 1 or 2 seats: .75 yard, 3 or 4 seats: 1.5 yards, 5 or 6 seats: 2.25 yards.

Contact Leland Customer Experience for yardage requirements on textiles with repeats.

For COL requirements please contact Leland Customer Experience.



Ease Side Chair, Ganging

	MODEL	LIST PRICE/GRADE	COM/COL	A	B	C	D	E	F	G	H	I	J	K	L
Upholstered seat, wood back	ESSGUW		\$684	716	733	750	767	784	801	818	835	852	869	886	903

Glides: Add \$8.00 net per chair for a set of four (4).

W 19.5 D 21.75 H 31 SH 18.5

COM Yardage: 1 or 2 seats: .75 yard, 3 or 4 seats: 1.5 yards, 5 or 6 seats: 2.25 yards.

Contact Leland Customer Experience for yardage requirements on textiles with repeats.

For COL requirements please contact Leland Customer Experience.



Ease Side Chair

	MODEL	LIST PRICE/GRADE	COM/COL	A	B	C	D	E	F	G	H	I	J	K	L
Upholstered seat, wood back upholstered back onlay	ESSUWU		\$670	703	720	737	754	771	788	805	822	839	856	873	890

Glides: Add \$8.00 net per chair for a set of four (4).

W 19.5 D 21.75 H 31 SH 18.5

COM Yardage: 1 seat and back: .75 yard, 6 seats and backs: 3.5 yards.

Contact Leland Customer Experience for yardage requirements on textiles with repeats.

For COL requirements please contact Leland Customer Experience.



Ease Side Chair, Ganging

	MODEL	LIST PRICE/GRADE	COM/COL	A	B	C	D	E	F	G	H	I	J	K	L
Upholstered seat, wood back upholstered back onlay	ESSGUWU		\$794	826	843	860	877	894	911	928	945	962	979	996	1013

Glides: Add \$8.00 net per chair for a set of four (4).

W 19.5 D 21.75 H 31 SH 18.5

COM Yardage: 1 seat and back: .75 yard, 6 seats and backs: 3.5 yards.

Contact Leland Customer Experience for yardage requirements on textiles with repeats.

For COL requirements please contact Leland Customer Experience.

To specify:

Please refer to pages 3-4 for complete specifying information.

Specify all products by their product code.

Pricing Effective: January 2025

EASE SIDE CHAIR
 Design: Leland Design Group

ES6



Ease Side Chair	MODEL	LIST PRICE
Wood seat, wood back W 19.5 D 21.75 H 31 SH 18	ESSWW	\$649
Glides: Add \$8.00 net per chair for a set of four (4).		



Ease Side Chair, Ganging	MODEL	LIST PRICE
Wood seat, wood back W 19.5 D 21.75 H 31 SH 18	ESSGWW	\$684
Glides: Add \$8.00 net per chair for a set of four (4).		

To specify:
 Please refer to pages 3-4 for
 complete specifying information.
 Specify all products by their
 product code.

Pricing Effective: January 2025

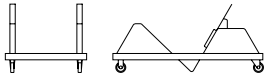

Ease Transport / Stacking Dolly			MODEL	LIST PRICE
W 22.75	D 46.4	H 14.25	ESSNDB	\$1120
(empty)				

Ease Transport/Stacking Dolly handles up to 25 side chairs in wood or 15 side chairs upholstered.

To specify:
Please refer to pages 3-4 for
complete specifying information.
Specify all products by their
product code.

5695 Eagle Drive, SE
Grand Rapids,
Michigan 49512
616-975-9260
lelandfurniture.com

Ebb Bench Fully Upholstered

January 2025 Price List



Ebb Fully Upholstered

Table of Contents	EB2
Specification Information	EB3
Specification Example	EB4
Two Closed Ends	EB5
One Linking End	EB6
Two Linking Ends	EB7
Auxiliary Options	EB8
Hub Specification Information	EB9
Hub Specification Example	EB10
Hub	EB11
Hub Auxiliary Options	EB12
Pod Specification Information	EB13
Pod Specification Example	EB14
Pod	EB15
Pod Auxiliary Options	EB16

Bench Model

DESCRIPTION	CODE
Ebb fully upholstered bench, two closed ends	EBFUCC
Ebb fully upholstered bench, one linking end	EBFUCL
Ebb fully upholstered bench, two linking ends	EBFULL

Bench Length

DESCRIPTION	CODE
30" Long	30
48" Long	48
72" Long	72
96" Long	96
120" Long	120

Fully Upholstered Selection

Please refer to Leland Textile Program which features textiles and leathers from the following partners:

- Camira
- Carnegie
- CF Stinson
- Green Hides
- Maharam
- Unika Vaev

The complete grade list can be found at www.lelandfurniture.com/resources or you can specify COM/COL. All non pre-approved textiles need be tested for compatibility.

Due to upholstery requirements, the Ebb product line can only be upholstered railroaded. Please consider when specifying textiles with a pattern. Untested COM or COL textiles will not be accepted.

Leg Finish

Ebb fully upholstered linking benches have black powder coat skirts.

DESCRIPTION	CODE
Sterling	ST
Warm Grey	WG
Cool Grey	CG
Black	B
White	W
Matte Mercury	MMR
Matte Mineral	MMN
Matte Burnish	MBN
Matte Foundry	MFN
Black Textured	BT
White Textured	WT
Chrome	C

Auxiliary Options

Auxiliary Options must be specified at the time of the order.

SKIRT:

DESCRIPTION	CODE
Ebb Fully Upholstered Bench Skirt	SK

FLOOR MOUNT:

DESCRIPTION	CODE
Ebb Fully Upholstered Bench Floor Mount	FM

*Floor Mount requires Skirt.

Glides

Ebb glides are nylon

Product Specification

Ebb layout is required at the quotation stage and order stage to ensure accurate product specifications. Contact Leland Customer Experience for CAD drawings.

Specifications required to create the product code

- Model
- Bench Length
- Upholstery Selection
- Leg Finish
- Skirt (when applicable)
- Floor Mount (when applicable)



MODEL

Ebb Fully Upholstered Bench
Two Closed Ends (EBFUCC)

BENCH LENGTH

72" (72)

UPHOLSTERY SELECTION

Enter upholstery grade,
COM or COL (COM)

LEG FINISH

Specify Standard Powder Coat

SKIRT

When Applicable, enter skirt code

FLOOR MOUNT

When Applicable, enter Ebb floor
mount code. Floor Mount requires Skirt.



EBB FULLY UPHOLSTERED BENCH TWO CLOSED ENDS

Design: Mark Gabbartas

EB5

Ebb Fully Upholstered Bench Two Closed Ends Skirt must be specified at the time of ordering. Skirt cannot be added later in the field.



Ebb Fully Upholstered Bench

Two Closed Ends

	MODEL	LIST PRICE/GRADE	COM/COL	A	B	C	D	E	F	G	H	I	J	K	L
30" Long	EBFUCC-30		\$2534	2750	2902	3054	3206	3358	3510	3662	3814	3966	4118	4270	4422

W 17.5 L 18.5

COM Yardage: 1.75 yards

For COL requirements please contact Leland Customer Care.



Ebb Fully Upholstered Bench

Two Closed Ends

	MODEL	LIST PRICE/GRADE	COM/COL	A	B	C	D	E	F	G	H	I	J	K	L
48" Long	EBFUCC-48		\$3338	3642	3851	4060	4269	4478	4687	4896	5105	5314	5523	5732	5941

W 17.5 L 18.5

COM Yardage: 2.75 yards

For COL requirements please contact Leland Customer Care.



Ebb Fully Upholstered Bench

Two Closed Ends

	MODEL	LIST PRICE/GRADE	COM/COL	A	B	C	D	E	F	G	H	I	J	K	L
72" Long	EBFUCC-72		\$4143	4521	4780	5039	5298	5557	5816	6075	6334	6593	6852	7111	7370

W 17.5 L 18.5

COM Yardage: 4.25 yards

For COL requirements please contact Leland Customer Care.



Ebb Fully Upholstered Bench

Two Closed Ends

	MODEL	LIST PRICE/GRADE	COM/COL	A	B	C	D	E	F	G	H	I	J	K	L
96" Long	EBFUCC-96		\$4944	5424	5751	6078	6405	6732	7059	7386	7713	8040	8367	8694	9021

W 17.5 L 18.5

COM Yardage: 5.5 yards

For COL requirements please contact Leland Customer Care.



Ebb Fully Upholstered Bench

Two Closed Ends

	MODEL	LIST PRICE/GRADE	COM/COL	A	B	C	D	E	F	G	H	I	J	K	L
120" Long	EBFUCC-120		\$5748	6326	6715	7104	7493	7882	8271	8660	9049	9438	9827	10216	10605

W 17.5 L 18.5

COM Yardage: 7 yards

For COL requirements please contact Leland Customer Care.

To specify:

Please refer to pages 3-4 for complete specifying information. Specify all products by their product code.

Pricing Effective: January 2025

EBB FULLY UPHOLSTERED BENCH ONE LINKING END

Design: Mark Gabbartas

EB6



Ebb Fully Upholstered Bench One Linking End

	MODEL	LIST PRICE/GRADE	COM/COL	A	B	C	D	E	F	G	H	I	J	K	L
30" Long	EBFUCL-30		\$2579	2796	2950	3104	3258	3412	3566	3720	3874	4028	4182	4336	4490

W 17.5 L 18.5

COM Yardage: 1.75 yards

For COL requirements please contact Leland Customer Care.



Ebb Fully Upholstered Bench One Linking End

	MODEL	LIST PRICE/GRADE	COM/COL	A	B	C	D	E	F	G	H	I	J	K	L
48" Long	EBFUCL-48		\$3383	3689	3900	4111	4322	4533	4744	4955	5166	5377	5588	5799	6010

W 17.5 L 18.5

COM Yardage: 2.75 yards

For COL requirements please contact Leland Customer Care.



Ebb Fully Upholstered Bench One Linking End

	MODEL	LIST PRICE/GRADE	COM/COL	A	B	C	D	E	F	G	H	I	J	K	L
72" Long	EBFUCL-72		\$4185	4566	4828	5090	5352	5614	5876	6138	6400	6662	6924	7186	7448

W 17.5 L 18.5

COM Yardage: 4.25 yards

For COL requirements please contact Leland Customer Care.



Ebb Fully Upholstered Bench One Linking End

	MODEL	LIST PRICE/GRADE	COM/COL	A	B	C	D	E	F	G	H	I	J	K	L
96" Long	EBFUCL-96		\$4988	5469	5796	6123	6450	6777	7104	7431	7758	8085	8412	8739	9066

W 17.5 L 18.5

COM Yardage: 5.5 yards

For COL requirements please contact Leland Customer Care.

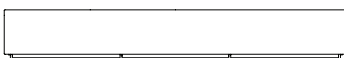

Ebb Fully Upholstered Bench One Linking End

	MODEL	LIST PRICE/GRADE	COM/COL	A	B	C	D	E	F	G	H	I	J	K	L
120" Long	EBFU-CL-120		\$5792	6369	6758	7147	7536	7925	8314	8703	9092	9481	9870	10259	10648

W 17.5 L 18.5

COM Yardage: 7 yards

For COL requirements please contact Leland Customer Care.

To specify:

Please refer to pages 3-4 for complete specifying information. Specify all products by their product code.

Pricing Effective: January 2025

EBB FULLY UPHOLSTERED BENCH TWO LINKING ENDS

Design: Mark Gabbartas

EB7



Ebb Fully Upholstered Bench Two Linking Ends

	MODEL	LIST PRICE/GRADE	COM/COL	A	B	C	D	E	F	G	H	I	J	K	L
30" Long	EBFULL-30		\$2621	2841	2994	3147	3300	3453	3606	3759	3912	4065	4218	4371	4524

W 17.5 L 18.5

COM Yardage: 1.75 yards

For COL requirements please contact Leland Customer Care.



Ebb Fully Upholstered Bench Two Linking Ends

	MODEL	LIST PRICE/GRADE	COM/COL	A	B	C	D	E	F	G	H	I	J	K	L
48" Long	EBFULL-48		\$3423	3730	3942	4154	4366	4578	4790	5002	5214	5426	5638	5850	6062

W 17.5 L 18.5

COM Yardage: 2.75 yards

For COL requirements please contact Leland Customer Care.



Ebb Fully Upholstered Bench Two Linking Ends

	MODEL	LIST PRICE/GRADE	COM/COL	A	B	C	D	E	F	G	H	I	J	K	L
72" Long	EBFULL-72		\$4232	4611	4875	5139	5403	5667	5931	6195	6459	6723	6987	7251	7515

W 17.5 L 18.5

COM Yardage: 4.25 yards

For COL requirements please contact Leland Customer Care.



Ebb Fully Upholstered Bench Two Linking Ends

	MODEL	LIST PRICE/GRADE	COM/COL	A	B	C	D	E	F	G	H	I	J	K	L
96" Long	EBFULL-96		\$5034	5515	5844	6173	6502	6831	7160	7489	7818	8147	8476	8805	9134

W 17.5 L 18.5

COM Yardage: 5.5 yards

For COL requirements please contact Leland Customer Care.



Ebb Fully Upholstered Bench Two Linking Ends

	MODEL	LIST PRICE/GRADE	COM/COL	A	B	C	D	E	F	G	H	I	J	K	L
120" Long	EBFULL-120		\$5838	6415	6809	7203	7597	7991	8385	8779	9173	9567	9961	10355	10749

W 17.5 L 18.5

COM Yardage: 7 yards

For COL requirements please contact Leland Customer Care.

To specify:

Please refer to pages 3-4 for complete specifying information. Specify all products by their product code.

Pricing Effective: January 2024

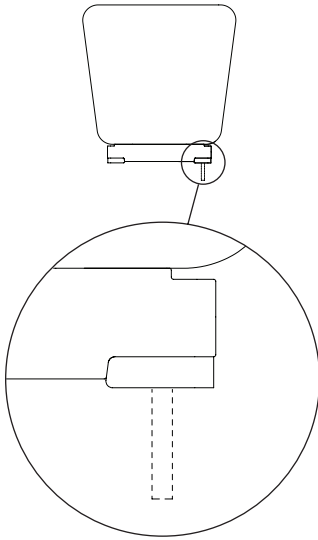

**Ebb Fully Upholstered Bench
Floor Mount**

	MODEL	LIST PRICE
	FM	\$281

Due to the variety of floor surfaces on which Ebb products may be installed, floor mount fasteners are not supplied by Leland International. The Ebb product floor mount option consists of feet with floor mount brackets designed to use .5" thread diameter fasteners. Responsibility of fastener choice is the customers.

Floor Mount requires a skirt and both must be specified at the time of ordering.

The Floor Mount cannot be added later in the field.



**Ebb Fully Upholstered Bench
Two Closed Ends Skirt**

	MODEL	LIST PRICE
Black Powdercoat Finish	SK	\$176

Ebb Fully Upholstered Bench Two Closed Ends Skirt must be specified at the time of ordering.

Skirt cannot be added later in the field.

Linking Ebb Benches come standard with skirt.

To specify:
Please refer to pages 3-4 for complete specifying information.
Specify all products by their product code.

Hub Model

DESCRIPTION	CODE
Ebb Hub, upholstered, one linking end	EBH1L
Ebb Hub, upholstered, two linking ends, 240 degrees	EBH2L
Ebb Hub, upholstered, two linking ends, 180 degrees	EBH3L
Ebb Hub, upholstered, three linking ends	EBH4L

Upholstery Selection

Please refer to Leland Textile Program which features textiles and leathers from the following partners:

- Camira
- Carnegie
- CF Stinson
- Green Hides
- Maharam
- Unika Vaev

The complete grade list can be found at www.lelandfurniture.com/resources or you can specify COM/COL. All non pre-approved textiles need to be tested for compatibility.

Due to upholstery requirements, the Ebb product line can only be upholstered railroaded. Please consider when specifying textiles with a pattern. Untested COM or COL textiles will not be accepted.

Powder Coat Frame Finishes

Ebb Fully Upholstered Hubs have black powder coat skirts.

DESCRIPTION	CODE
Sterling	ST
Warm Grey	WG
Cool Grey	CG
Black	B
White	W
Matte Gold Rush	MGR
Matte Mercury	MMR
Matte Mineral	MMN
Matte Burnish	MBN
Matte Foundry	MFN
Black Textured	BT
Grey Textured	GT
White Textured	WT
Chrome	C

Auxiliary Options

Auxiliary Options must be specified at the time of the order.

DESCRIPTION	CODE
Ebb Fully Upholstered Hub Floor Mount	FM

Glides

Ebb glides are nylon.

Product Specification

Ebb layout is required at the quotation stage and order stage to ensure accurate product specifications. Contact Leland Customer Care for CAD drawings.

Specifications required to create the product code

- Model
- Model
- Upholstery Selection
- Leg Finish
- Floor Mount (when applicable)



MODEL

Ebb Fully Upholstered Hub - One Linking End (EBH1L)

UPHOLSTERY SELECTION

Enter upholstery grade, COM or COL. Grade J (J)

LEG FINISH

Specify Standard Powder Coat

FLOOR MOUNT

When Applicable, enter Ebb floor mount code



EBB FULLY UPHOLSTERED HUB
Design: Mark Gabbartas

EB11

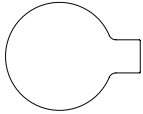

Ebb Fully Upholstered Hub	MODEL	LIST PRICE/GRADE	COM/COL	A	B	C	D	E	F	G	H	I	J	K	L
One linking end	EBH1L	\$8076	8923	9488	10053	10618	11183	11748	12313	12878	13443	14008	14573	15138	

DIA 60 EXT 15

COM Yardage: 5.25 yards
For COL requirements please contact Leland Customer Care.
Unit comes with skirt.

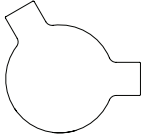

Ebb Fully Upholstered Hub	MODEL	LIST PRICE/GRADE	COM/COL	A	B	C	D	E	F	G	H	I	J	K	L
Two linking ends, 240 degrees	EBH2L	\$8506	9470	10105	10740	11375	12010	12645	13280	13915	14550	15185	15820	16455	

DIA 60 EXT 15

COM Yardage: 5.75 yards
For COL requirements please contact Leland Customer Care.
Unit comes with skirt.

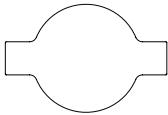

Ebb Fully Upholstered Hub	MODEL	LIST PRICE/GRADE	COM/COL	A	B	C	D	E	F	G	H	I	J	K	L
Two linking ends, 180 degrees	EBH3L	\$8506	9470	10105	10740	11375	12010	12645	13280	13915	14550	15185	15820	16455	

DIA 60 EXT 15

COM Yardage: 7 yards
For COL requirements please contact Leland Customer Care.
Unit comes with skirt.

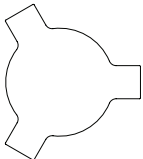

Ebb Fully Upholstered Hub	MODEL	LIST PRICE/GRADE	COM/COL	A	B	C	D	E	F	G	H	I	J	K	L
Three linking ends	EBH4L	\$8935	10009	10710	11411	12112	12813	13514	14215	14916	15617	16318	17019	17720	

DIA 60 EXT 15

COM Yardage: 8 yards
For COL requirements please contact Leland Customer Care.
Unit comes with skirt.

To specify:
Please refer to pages 9-10 for complete specifying information.
Specify all products by their product code.

Pricing Effective: January 2025

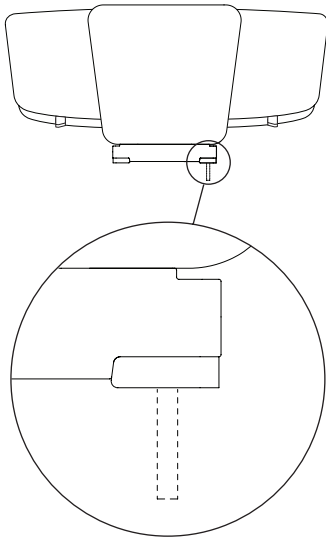

**Ebb Fully Upholstered Hub
 Floor Mount**

MODEL

LIST PRICE

FM

\$281

Due to the variety of floor surfaces on which Ebb products may be installed, floor mount fasteners are not supplied by Leland International. The Ebb product floor mount option consists of feet with floor mount brackets designed to use .5" thread diameter fasteners. Responsibility of fastener choice is the customers.

Floor Mount requires a skirt and both must be specified at the time of ordering.

The Floor Mount cannot be added later in the field.

To specify:

**Please refer to pages 9-10 for
 complete specifying information.**

**Specify all products by their
 product code.**

Pod Model

DESCRIPTION	CODE
Ebb Fully Upholstered Pod	EBH5

Upholstery Selection

Please refer to Leland Textile Program which features textiles and leathers from the following partners:

- Camira
- Green Hides
- Carnegie
- Maharam
- CF Stinson
- Unika Vaev

The complete grade list can be found at www.lelandfurniture.com/resources or you can specify COM/COL.

Due to upholstery requirements, the Ebb product line can only be upholstered railroaded. Please consider when specifying textiles with a pattern. Untested COM or COL textiles will not be accepted.

Leg Finish

DESCRIPTION	CODE
Sterling	ST
Warm Grey	WG
Cool Grey	CG
Black	B
White	W
Matte Gold Rush	MGR
Matte Mercury	MMR
Matte Mineral	MMN
Matte Burnish	MBN
Matte Foundry	MFN
Black Textured	BT
Grey Textured	GT
White Textured	WT
Chrome	C

Auxiliary Options

Auxiliary Options must be specified at the time of the order.

SKIRT:

DESCRIPTION	CODE
Ebb Fully Upholstered Pod Skirt	SK

FLOOR MAT:

DESCRIPTION	CODE
Ebb Fully Upholstered Pod Floor Mount	FM
Floor Mount requires Skirt.	

Glides

Ebb glides are nylon.

Product Specification

Ebb layout is required at the quotation stage and order stage to ensure accurate product specifications. Contact Leland Customer Experience for CAD drawings.

Specifications required to create the product code

- Model
- Upholstery Selection
- Leg Finish
- Skirt (when applicable)
- Floor Mount (when applicable)



MODEL

Ebb Fully Upholstered Pod (EBH5)

UPHOLSTERY SELECTION

Enter upholstery grade, COM or COL. Grade J (J)

LEG FINISH

Specify Standard Powder Coat

SKIRT

Skirt (SK)

FLOOR MOUNT

When applicable, enter Ebb floor mount code. Floor Mount requires Skirt.



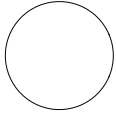

Ebb Fully Upholstered Pod	MODEL	LIST PRICE/GRADE	COM/COL	A	B	C	D	E	F	G	H	I	J	K	L
No linking end	EBH5		\$7470	8299	8850	9401	9952	10503	11054	11605	12156	12707	13258	13809	14360

DIA 54 SH 18.5

COM Yardage: 6 yards

For COL requirements please contact Leland Customer Care.

To specify:
Please refer to pages 13-14 for
complete specifying information.
Specify all products by their
product code.

EBB FULLY UPHOLSTERED POD AUXILIARY OPTIONS

Design: Mark Gabbartas

EB16

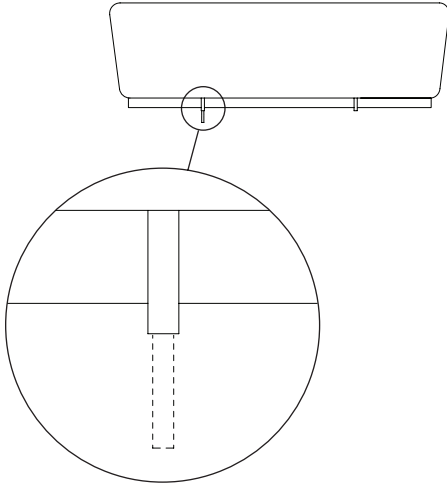

**Ebb Fully Upholstered Pod
Floor Mount**

	MODEL	LIST PRICE
	FM	\$281

Due to the variety of floor surfaces on which Ebb products may be installed, floor mount fasteners are not supplied by Leland International. The Ebb product floor mount option consists of feet with floor mount brackets designed to use .5" thread diameter fasteners. Responsibility of fastener choice is the customers.

Floor Mount requires a skirt and both must be specified at the time of ordering.

The Floor Mount cannot be added later in the field.



**Ebb Fully Upholstered Pod
Skirt**

	MODEL	LIST PRICE
Black Powdercoat Finish	SK	\$176

Ebb Fully Upholstered Pod Skirt must be specified at the time of ordering.

Skirt cannot be added later in the field.

To specify:
Please refer to pages 13-14 for complete specifying information.
Specify all products by their product code.

Pricing Effective: January 2025

5695 Eagle Drive, SE
Grand Rapids,
Michigan 49512
616-975-9260
lelandfurniture.com













Fast Table

January 2025 Price List



Fast Table

Table of Contents	FT2
Visual Reference	FT3
Table Top Specification Information	FT4
Table Top Specification Example	FT5
Table Tops	FT6
Table Base Specification Information	FT7
Table Base Specification Example	FT8
Table Bases	FT9
Modesty Panel Specification Information	FT10
Modesty Panel Specification Example	FT11
Modesty Panel	FT12
Transport Trolley Specification Information	FT13
Transport Trolley Specification Example	FT14
Transport Trolley	FT15

TABLE MODEL	TABLE TOP SIZES			BASE	PAGE
Size A	Round	Sqaure	Rectangle	Powdercoat	Top: Page 6 Base: Page 9
	 48 DIA 54 DIA	 42 x 42	 24 x 48 30 x 48		
Size B	Round	Sqaure	Rectangle	Powdercoat	Top: Page 6 Base: Page 9
	 60 DIA	 48 x 48	 24 x 60 30 x 60		
Size C	Round	Sqaure	Rectangle	Powdercoat	Top: Page 6 Base: Page 9
	 72 DIA	 54 x 54	 24 x 72 30 x 72		

To specify:
Please refer to pages 3-4 for complete specifying information.
Specify all products by their product code.

Due to the design intent of Fast, table tops and table bases are sold separately. This page is for specifying the table top only.

Table Top Model

ROUND	FITS BASE	CODE
48 DIA	A	F48A
54 DIA	A	F54A
60 DIA	B	F60B
72 DIA	C	F72C
SQUARE		
42x42	A	F4242A
48x48	B	F4848B
54x54	C	F5454C
RECTANGLE		
24x48	A	F2448A
30x48	A	F3048A
24x60	B	F2460B
30x60	B	F3060B
24x72	C	F2472C
30x72	C	F3072C

Top Surface

LAMINATE TOPS:

DESCRIPTION	CODE
Identify manufacturer, laminate code, & color	L

Please refer to the Leland Terms and Conditions Guide for a listing of standard laminates. For table pricing in laminates not listed, please contact Leland's Customer Experience Department for a quotation.

Edge Type

V7 VINYL EDGE:

.75" 3mm PVC



Edge Color

V7 VINYL EDGE COLORS:

DESCRIPTION	CODE
Black	B
Grey	G
Pewter	PW
Saddle	SL
Stone	SN
Truffle	TF
White	W
Bluestone	BST
Indian Smoke	ISM
Nubian Brown	NBR
Amazon	AMZ
Taupe	TPE

Attachment Color

DESCRIPTION	CODE
Black	B

Auxiliary Options

DESCRIPTION	CODE
Ganging Device (two per set)	GD

Product Weights

BASES	LBS
FBA	15
FBB	20
FBC	25

ROUND	FITS BASE	LBS
48 DIA	A	50
54 DIA	A	60
60 DIA	B	65
72 DIA	C	75

SQUARE	LBS
42x42	50
48x48	60
54x54	70

RECTANGLE	LBS
24x48	30
30x48	40
24x60	35
30x60	45
24x72	45
30x72	55

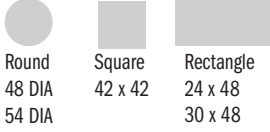
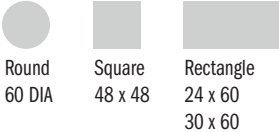
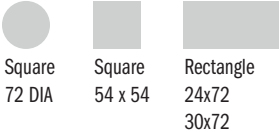
Fast Table Top	MODEL	FRAME FINISH	LIST PRICE
<p>Top Sizes for Base A</p>  <p>Round 48 DIA 54 DIA</p> <p>Square 42 x 42</p> <p>Rectangle 24 x 48 30 x 48</p>		Laminate Top	
	F48A	48 DIA	\$1438
	F54A	54 DIA	\$1466
	F60B	60 DIA	\$1496
	F72C	72 DIA	\$3982
<p>Top Sizes for Base B</p>  <p>Round 60 DIA</p> <p>Square 48 x 48</p> <p>Rectangle 24 x 60 30 x 60</p>	F4242A	42x42	\$1105
	F4848B	48x48	\$1137
	F5454C	54x54	\$1635
	F2448A	24x48	\$615
	F3048A	30x48	\$725
<p>Top Sizes for Base C</p>  <p>Square 72 DIA</p> <p>Square 54 x 54</p> <p>Rectangle 24x72 30x72</p>	F2460B	24x60	\$756
	F3060B	30x60	\$874
	F2472C	24x72	\$855
	F3072C	30x72	\$1022

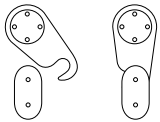

Ganging Device	MODEL	LIST PRICE
Two per set	GD	\$202

To specify:
 Please refer to pages 3-4 for complete specifying information.
 Specify all products by their product code.

Due to the design intent of Fast, table tops and table bases are sold separately. This page is for specifying the table bases only.

Table Base Model

DESCRIPTION	CODE
Base A (fits 48 Dia, 54 Dia, 42x42, 24x48 and 30x48)	FBA
Base B (fits 60 Dia, 48x48, 24x60 and 30x60)	FBB
Base C (fits 72 Dia, 54x54, 24x72 and 30x72)	FBC

Base Finish

DESCRIPTION	CODE
Sterling	ST
Dolphin Textured	DLT
Oxford Textured	OXT
Black Textured	BT
White Textured	WT
Matte Mercury	MMR
Matte Mineral	MMN
Matte Burnish	MBN
Matte Foundry	MFN
Matte Blue Sky	MBS
Matte Forest	MFO
Matte Sienna	MSN
Matte Willow	MWL
Matte Fawn	MFW
Matte Pistachio	MPS
Matte Fog	MFG
Matte Pine	MPN
Matte Seafoam	MSF
Matte Dijon	MDJ

Glide and Attachment Color

DESCRIPTION	CODE
Black	B

Freight Note

Due to the size and nature of Fast Tables, the Freight Program does not apply to this product. Please contact Customer Experience for a quote.

Specifications required to create the product code

- Model
- Base Finish
- Glide and Attachment Color

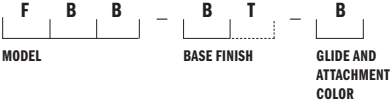

MODEL

Fast Size B Table Base (FBB)

BASE FINISH

Black Textured (BT)

GLIDE AND ATTACHMENT COLOR

Black (B)



FAST TABLE BASES

Design: Carlos Tíscar, licensed by Sellex

FT9



Base Size A	MODEL	LIST PRICE
W 46.7 H 27.4	FBA	\$1381

Fits Top Sizes:



Round
48 DIA
54 DIA



Square
42 x 42



Rectangle
24 x 48
30 x 48

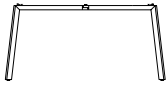

Base Size B	MODEL	LIST PRICE
W 57.8 H 27.4	FBB	\$1408

Fits Top Sizes:



Round
60 DIA



Square
48 x 48



Rectangle
24 x 60
30 x 60

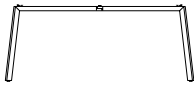

Base Size C	MODEL	LIST PRICE
W 68 H 27.4	FBC	\$1438

Fits Top Sizes:



Round
72 DIA



Square
54 x 54



Rectangle
24 x 72
30 x 72

To specify:

Please refer to table bases on pages 4-5 and table tops on pages 7-8 for complete specifying information.

Specify all products by their product code.

Model

DESCRIPTION	FITS BASE	CODE
Modesty panel for 24x48 table	A	FM2448
Modesty panel for 30x48 table	A	FM3048
Modesty panel for 24x60 table	B	FM2460
Modesty panel for 30x60 table	B	FM3060
Modesty panel for 24x72 table	C	FM2472
Modesty panel for 30x72 table	C	FM3072

Modesty Panel Cover

DESCRIPTION	CODE
Grey	G

Optional Modesty Panel Cover (Orders of 20+ Units)

DESCRIPTION	CODE
Black	B
White	W

Specifications required to create the product code

- Model
- Modesty Panel Color

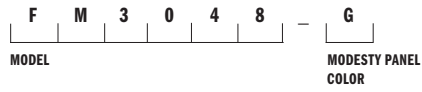

MODEL

Fast Modesty Panel for 30 x 48
Table (FM3048)

MODESTY PANEL COVER

Grey (G)



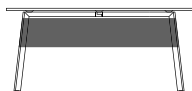

Modesty Panel	MODEL	SIZE	LIST PRICE
		Base A	
	FM2448	24x48	\$303
	FM3048	30x48	\$303
		Base B	
	FM2460	24x60	\$317
	FM3060	30x60	\$317
		Base C	
	FM2472	24x72	\$336
	FM3072	30x72	\$336

To specify:
 Please refer to table bases on pages 4-5, table tops on pages 7-8 and modesty panels on pages 10-11 for complete specifying information. Specify all products by their product code.

Model

DESCRIPTION	CODE
Fast Transport Trolley	FTT

Specifications required to create the product code

Model



MODEL

Fast Transport Trolley (FTT)



FAST TRANSPORT TROLLEY
 Design: Carlos Tíscar, licensed by Sellex

FT15

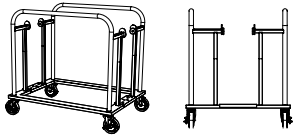

Fast Transport Trolley	MODEL	LIST PRICE
Black powder coat finish	FTT	\$2671
W 38.75 D 29.5 H 37.5		

The Fast Transport Trolley can hold up to 6 table bases and 6 table tops.

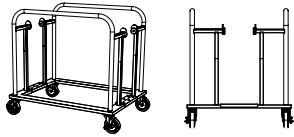

Fast Transport Trolley	MODEL	LIST PRICE
Black powder coat finish	FTT-72	\$2939
W 38.75 D 29.5 H 37.5		

The Fast Transport Trolley can hold up to (6) C table bases and (4) 72 DIA table tops.

To specify:
 Please refer to page 13-14 for complete
 specifying information. Specify all products by
 their product code.

5695 Eagle Drive, SE
Grand Rapids,
Michigan 49512
616-975-9260
lelandfurniture.com

Fixed Table

January 2025 Price List



Fixed Table

Table of Contents	FXT2
Visual Reference	FXT3
Specification Information	FXT4
Specification Example	FXT5
Power Planning	FXT6
Round Table	FXT7
Square Table	FXT8
Rectangular Table	FXT9
Counter Height Rectangular Tables	FXT11
Rectangular Bar Height Table	FXT13
Auxiliary Options	FXT15

TABLE MODEL	TABLE TOP SIZES	OPTIONAL POWER	PAGE
Round table	Round  42 DIA 48 DIA 54 DIA 60 DIA	1 Simplex Dual USB	6

TABLE MODEL	TABLE TOP SIZES	OPTIONAL POWER	PAGE
Square table	Square  42 x 42 48 x 48 54 x 54 60 x 60	1 Simplex Dual USB	7

TABLE MODEL	TABLE TOP SIZES	OPTIONAL POWER	PAGE
Rectangular table	Rectangle  30 x 60 36 x 72 42 x 84 30 x 72 36 x 84 42 x 96 30 x 84 36 x 96 42 x 120 36 x 120	2 Simplex units, 1 Dual USB 1 Simplex Dual USB	8

TABLE MODEL	TABLE TOP SIZES	OPTIONAL POWER	PAGE
Rectangular table Counter height	Rectangle  30 x 60 36 x 72 42 x 84 30 x 72 36 x 84 42 x 96 30 x 84 36 x 96 42 x 120 36 x 120	2 Simplex units, 1 Dual USB 1 Simplex Dual USB	9

TABLE MODEL	TABLE TOP SIZES	OPTIONAL POWER	PAGE
Rectangular table Bar height	Rectangle  30 x 60 36 x 72 42 x 84 30 x 72 36 x 84 42 x 96 30 x 84 36 x 96 42 x 120 36 x 120	2 Simplex units, 1 Dual USB 1 Simplex Dual USB	9

Table Model

DESCRIPTION	CODE
Fixed Table	FXT

Top Selection

ROUND		SQUARE	
DESCRIPTION	CODE	DESCRIPTION	CODE
42D	42D-29	42x42	4242-29
48D	48D-29	48x48	4848-29
54D	54D-29	54x54	5454-29
60D	60D-29	60x60	6060-29

RECTANGULAR		COUNTER HEIGHT RECTANGULAR	
DESCRIPTION	CODE	DESCRIPTION	CODE
30x60	3060-29	30x60	3060-36
30x72	3072-29	30x72	3072-36
30x84	3084-29	30x84	3084-36
36x72	3672-29	36x72	3672-36
36x84	3684-29	36x84	3684-36
36x96	3696-29	36x96	3696-36
36x120	36120-29	36x120	36120-36
42x84	4284-29	42x84	4284-36
42x96	4296-29	42x96	4296-36
42x120	42120-29	42x120	42120-36

BAR HEIGHT RECTANGULAR	
DESCRIPTION	CODE
30x60	3060-42
30x72	3072-42
30x84	3084-42
36x72	3672-42
36x84	3684-42
36x96	3696-42
36x120	36120-42
42x84	4284-42
42x96	4296-42
42x120	42120-42

Top and Edge Finish

HPL (HIGH PRESSURE LAMINATE)	
DESCRIPTION	CODE
Platinum Wilsonart® (D315-60)	LGP
Black Pionite® (SE101)	LBK
White Wilsonart® (D354-60)	LWH

Edge finish options: Matching ABS (V5), natural (11) plywood (W2)
 Please refer to the Leland Terms and Conditions Guide for a listing of standard laminates.
 For table pricing in laminates not listed, please contact Leland's Customer Experience Department for a quotation.

FORBO	
DESCRIPTION	CODE
Pearl	4157
Mauve	4172
Pebble	4175
Smokey Blue	4179
Olive	4184

Edge finish options: natural (11) plywood (W2)

Pricing Effective: January 2025

Top and Edge Finish (cont.)



FORMICA SOLID SURFACE	
DESCRIPTION	CODE
Luna Steel	FR415
Frost	FR103
Black Lava Terrazzo	FR501
Grafite Terrazzo	FR411
Dalmata Terrazzo	FR412
Frosted Gray Terrazzo	FR622
White Renew Terrazzo	FR748
Gray Renew Terrazzo	FR749

Edge finish options: S1 Edge (FR415 & FR103) and S2 Edge (FR501,FR411, FR412, FR622, FR748, & FR749)

Leg Finish

DESCRIPTION	CODE
White Textured Powder coat	WT
Black Textured Powder coat	BT

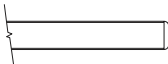
Edge Type

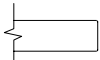
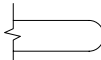
DESCRIPTION	CODE	DESCRIPTION	CODE
3/4" flat PVC	V5	1" flat plywood	W2
			
1" square (Solid Color Corian Tops)	S1	1" bullnose (Terrazzo Corian Tops)	S2
			

Glide Type

DESCRIPTION
Standard (Black nylon adjustable leveling)

Power Options

DESCRIPTION	CODE
Single Simplex Unit (centered)	PWR
Dual USB Unit (centered)	USB
Power Kit	KIT

*(2) Single Simplex & (1) Dual USB (only available on rectangular tables)

Auxiliary Options

DESCRIPTION	CODE
Storage Caddy	SC

*only available on rectangular tables

Specifications required to create the product code

- Model
- Top Selection
- Top Finish
- Leg Finish
- Edge Type
- Power (if applicable)
- Auxiliary Option (if applicable)
- Glide Type



MODEL

Fixed Table (FXT)

TOP SELECTION

Counter Height Rectangular
(3060-36)

TOP FINISH

Black Laminate (LBK)

LEG FINISH

Black Textured Powder coat (BT)

EDGE TYPE

1" flat plywood (W2)

POWER

When applicable enter power option (see page FXT6 for options)

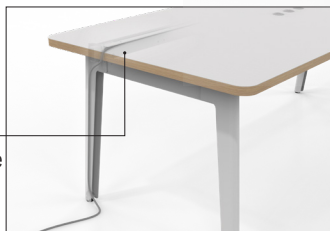

AUXILIARY OPTION

Storage Caddy (SC)

GLIDE

Standard (S)



Options

- Single Simplex Unit (centered, includes 120" plug-in infeed) (PWR)
- Dual USB Unit (centered) (USB)
- Power Kit (KIT)
- *(2) Single Simplex & (1) Dual USB (only available on rectangular tables, centered)



Single Simplex Unit



Dual USB



Wire Management

Power Kit (-KIT)

- *(2) Single Simplex & (1) Dual USB (only available on rectangular tables, centered)



FIXED TABLE ROUND
 Design: 2B Studio, Justin Burton

FXT7



Fixed Table Round

	MODEL	TOP SIZE/CODE	LIST PRICE/EDGE CODES:	V5	W2
Powder coat base	FXT-	Laminate Top			
H 29		42D		\$2338	2690
		48D		\$2400	2831
		54D		\$2462	2955
		60D		\$2533	3089
		Forbo Top			W2
		42D			\$2808
		48D			\$2881
		54D			\$2956
		60D			\$3046
		Formica Solid Surface	S1		
		42D		\$5829	
		48D		\$6037	
		54D		\$6234	
		60D		\$6416	
		Terrazzo Formica Top	S2		
		42D		\$9655	
		48D		\$11220	
		54D		\$12234	
		60D		\$13242	



- Round
- 42 DIA
- 48 DIA
- 54 DIA
- 60 DIA

To specify:
 Please refer to pages 3-4 for complete specifying information.
 Specify all products by their product code.

FIXED TABLE SQUARE
 Design: 2B Studio, Justin Burton

FXT8

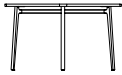

Fixed Table Square

	MODEL	TOP SIZE/CODE	LIST PRICE/EDGE CODES:	V5	W2
Powder coat base	FXT-	Laminate Top			
H 29		42x42		\$2338	2690
		48x48		\$2400	2831
		54x54		\$2462	2955
		60x60		\$2533	3089
		Forbo Top			W2
		42x42			\$2808
		48x48			\$2881
		54x54			\$2956
		60x60			\$3046
		Formica Solid Surface	S1		
		42x42		\$5829	
		48x48		\$2337	
		54x54		\$6234	
		60x60		\$6416	
		Terrazzo Formica Top	S2		
		42x42		\$9655	
		48x48		\$11220	
		54x54		\$12234	
		60x60		\$13242	



Square

42x42

48x48

54x54

60x60

To specify:

Please refer to pages 3-4 for complete specifying information.

Specify all products by their product code.

Pricing Effective: January 2025

FIXED TABLE RECTANGULAR
 Design: 2B Studio, Justin Burton

FXT9



Fixed Table Rectangular	MODEL	TOP SIZE/CODE	LIST PRICE/ EDGE CODES:	V5	W2
Powder coat base	FXT-	Laminate Top			
H 29		30x60		\$2462	2830
		30x72		\$2653	3052
		30x84		\$2831	3341
		36x72		\$3035	3582
		36x84		\$3326	3989
		36x96		\$3523	4295
		36x120		\$4008	5008
		42x84		\$3663	4539
		42x96		\$3805	4717
		42x120		\$4089	5076
		Forbo Top			W2
		30x60			\$3027
		30x72			\$3264
		30x84			\$3487
		36x60			\$3734
		36x72			\$4059
		36x96			\$4296
		36x120			\$4859
		42x84			\$4482
		42x96			\$4660
		42x120			\$5018

To specify:
 Please refer to pages 3-4 for complete specifying information.
 Specify all products by their product code.

Pricing Effective: January 2025

FIXED TABLE RECTANGULAR cont.
 Design: 2B Studio, Justin Burton

FXT10



Fixed Table Rectangular

	MODEL	TOP SIZE/CODE	LIST PRICE/EDGE CODES:	
Powder coat base	FXT-	Formica Solid Surface	S1	
H 29		30x60	\$5981	
		30x72	\$6148	
		30x84	\$6351	
		36x72	\$6532	
		36x84	\$6707	
		36x96	\$6854	
		36x120	\$7175	
		42x84	\$7026	
		42x96	\$7156	
		42x120	\$7416	
			Terrazzi Formica Top	S2
			30x60	\$7582
		30x72	\$8162	
		30x84	\$8702	
		36x60	\$11186	
		36x72	\$12239	
		36x96	\$12951	
		36x120	\$14718	
		42x84	\$13482	
		42x96	\$14151	
		42x120	\$15492	

To specify:
 Please refer to pages 3-4 for complete specifying information.
 Specify all products by their product code.

Pricing Effective: January 2025

FIXED TABLE COUNTER HEIGHT RECTANGULAR
 Design: 2B Studio, Justin Burton

FXT11



Fixed Table Counter Height Rectangular

	MODEL	TOP SIZE/CODE	LIST PRICE/EDGE CODES:	V5	W2
Powder coat base	FXT-	Laminate Top			
H 36		30x60		\$3745	4306
		30x72		\$3886	4469
		30x84		\$4028	4752
		36x72		\$4152	4899
		36x84		\$4276	5130
		36x96		\$4387	5263
		36x120		\$4621	5629
		42x84		\$4546	5546
		42x96		\$4608	5619
		42x120		\$4732	5768
		Forbo Top			W2
		30x60			\$3898
		30x72			\$4043
		30x84			\$4190
		36x60			\$4319
		36x72			\$4448
		36x96			\$4563
		36x120			\$4807
		42x84			\$4730
		42x96			\$4779
		42x120			\$4880



Rectangle

30x60

30x84

36x72

36x84

36x96

36x120

42x84

42x96

42x120

To specify:
 Please refer to pages 3-4 for complete specifying information.
 Specify all products by their product code.

Pricing Effective: January 2025

FIXED TABLE COUNTER HEIGHT RECTANGULAR cont.
 Design: 2B Studio, Justin Burton

FXT12



Fixed Table Counter Height Rectangular

	MODEL	TOP SIZE/CODE	LIST PRICE/EDGE CODES:
Powder coat base	FXT-	Formica Solid Surface	S1
H 36		30x60	\$6899
		30x72	\$7003
		30x84	\$7140
		36x72	\$7272
		36x84	\$7396
		36x96	\$7558
		36x120	\$7844
		42x84	\$7681
		42x96	\$7871
		42x120	\$8254
		Terrazzi Formica Top	S2
		30x60	\$10242
		30x72	\$10625
		30x84	\$11010
		36x60	\$13612
		36x72	\$14160
		36x96	\$14372
		36x120	\$15133
		42x84	\$14933
		42x96	\$15093
		42x120	\$15417

To specify:
 Please refer to pages 3-4 for complete specifying information.
 Specify all products by their product code.

FIXED TABLE BAR HEIGHT RECTANGULAR
 Design: 2B Studio, Justin Burton

FXT13

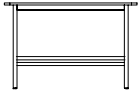

Fixed Table Bar Height Rectangular

	MODEL	TOP SIZE/CODE	LIST PRICE/EDGE CODES:	V5	W2
Powder coat base	FXT-	Laminate Top			
H 42		30x60		\$3776	4342
		30x72		\$3917	4504
		30x84		\$4059	4790
		36x72		\$4183	4934
		36x84		\$4306	5168
		36x96		\$4418	5300
		36x120		\$4650	5666
		42x84		\$4577	5585
		42x96		\$4639	5660
		42x120		\$4763	5810
		Forbo Top			W2
		30x60			\$3928
		30x72			\$4075
		30x84			\$4221
		36x60			\$4349
		36x72			\$4479
		36x96			\$4581
		36x120			\$4812
		42x84			\$4760
		42x96			\$4810
		42x120			\$4912

To specify:
 Please refer to pages 3-4 for complete specifying information.
 Specify all products by their product code.

Pricing Effective: January 2025

FIXED TABLE BAR HEIGHT RECTANGULAR cont.
 Design: 2B Studio, Justin Burton

FXT14



Fixed Table Bar Height Rectangular

	MODEL	TOP SIZE/CODE	LIST PRICE/EDGE CODES:
Powder coat base	FXT-	Formica Solid Surface	S1
H 42		30x60	\$6996
		30x72	\$7112
		30x84	\$7161
		36x72	\$7293
		36x84	\$7422
		36x96	\$7560
		36x120	\$7826
		42x84	\$7709
		42x96	\$7896
		42x120	\$8272
		Terrazzi Formica Top	S2
		30x60	\$10203
		30x72	\$10586
		30x84	\$10968
		36x60	\$13563
		36x72	\$13965
		36x96	\$14325
		36x120	\$15086
		42x84	\$14844
		42x96	\$15271
		42x120	\$16124

To specify:
 Please refer to pages 3-4 for complete specifying information.
 Specify all products by their product code.

Pricing Effective: January 2025

Single Simplex Unit	MODEL	LIST PRICE
	PWR	\$143

Dual USB Unit	MODEL	LIST PRICE
	USB	\$255

Power Kit	MODEL	LIST PRICE
	KIT	\$1579

Fixed Table Storage Caddy	MODEL	LIST PRICE
	SC	\$464

To specify:
Please refer to pages 3-4 for
complete specifying information.
Specify all products by their
product code.

5695 Eagle Drive, SE
Grand Rapids,
Michigan 49512
616-975-9260
lelandfurniture.com

Fly Table

January 2025 Price List



Fly Table

Table of Contents	FLY2
Specification Information	FLY3
Specification Example	FLY4
Textured Paint	FLY5
HPL	FLY5
Wood Veneer	FLY6

Table Model

DESCRIPTION	CODE
Fly Table	FLY

Top Collection

RECTANGLE

DESCRIPTION	CODE
30x60	3060
36x72	3672
42x84	4284

ROUND

DESCRIPTION	CODE
30D	30D
36D	36D
42D	42D
48D	48D

LEFT HAND 'L'

DESCRIPTION	CODE
40x55	4055L
46x63	4663L
52x72	5272L

OVAL

DESCRIPTION	CODE
30x60	3060O
36x72	3672O
42x84	4284O
48x96	4896O

RIGHT HAND 'R'

DESCRIPTION	CODE
40x55	4055R
46x63	4663R
52x72	5272R

VISUAL REFERENCE:



Left and right hand designations are as seated.

Top and Edge Finish

WOOD VENEER TEXTURED PAINT

DESCRIPTION	CODE	DESCRIPTION	CODE
Rift Cut Oak	O	White	WT
Walnut	W	Black	BT
		Grey	GT

Edge finish options:

Natural	11	Edge finish painted to match
Oak stain match	O	
Walnut stain match	W	

HPL (HIGH PRESSURE LAMINATE)

DESCRIPTION	CODE
Grey	Platinum Wilsonart® (D315-60)
Black	Black Pionite® (SE101)
White Designer	White Wilsonart® (D354-60)

Edge Finish Natural (11) Plywood only

Leg Selection

DESCRIPTION	CODE
Powder coat Legs	P
Polished Aluminum Legs	PA

Leg Finish (when applicable)

DESCRIPTION	CODE
White Textured Powder coat	WT
Black Textured Powder coat	BT

*Please Note: Leg finish specification is required ONLY for Powder coat (P) legs

Edge Type

STANDARD EDGE:

reverse back bevel

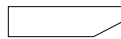

Glide Type

DESCRIPTION	CODE
Black Rubber Glide	S

Auxiliary Options

DESCRIPTION	CODE	DESCRIPTION	CODE
Power Flip Top Grommet	PT	Front Divider Screen	FD
Cable Duct	CD	Side Divider Screen	SD
Textile Cable Tray	CT	Courtesy Screen	CS
Ganging	G		

Auxiliary options are priced upon request. Please contact Customer Experience (800) 859-7510 for pricing.

Specifications required to create the product code

- Table Model
- Top Selection
- Top Finish
- Leg Selection
- Leg Finish
- Glide Selection

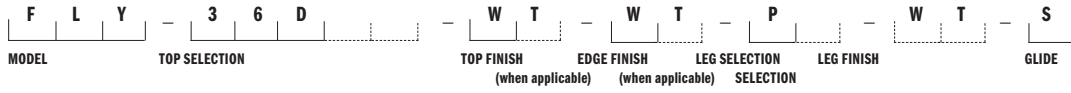

MODEL

Fly Table (FLY)

TOP SELECTION

36 Diameter Round (36D)

TOP FINISH

White Textured Paint (WT)

EDGE FINISH

White Textured Paint (WT)

LEG SELECTION

Powder coat (P)

LEG FINISH

White Textured Paint (WT)

GLIDE SELECTION





Standard Glide (S)







FLY TABLE

Design: Lievore Altherr Molina, licensed by Sellex

FLY5

Textured Paint Top			TOP SHAPE	TOP SIZE	POWDERCOAT LEGS	POLISHED ALUMINUM LEGS
H 29.5	Top Shape		Rectangle	30x60	\$2163	\$2302
				36x72	\$2470	\$2606
				42x84	\$2833	\$2968
			L - Table	40x55	\$2321	\$2458
				46x63	\$2589	\$2726
				52x72	\$2916	\$3053
			Round	30D	\$1816	\$1954
				36D	\$1968	\$2104
				42D	\$2148	\$2287
			Oval	30x60	\$2241	\$2379
				36x72	\$2578	\$2716
				42x84	\$2976	\$3115
				48x96	\$3156	\$3294





HPL Top (High Pressure Laminate)			TOP SHAPE	TOP SIZE	POWDERCOAT LEGS	POLISHED ALUMINUM LEGS
H 29.5	Top Shape		Rectangle	30x60	\$2239	\$2377
				36x72	\$2576	\$2714
				42x84	\$2974	\$3112
			L - Table	40x55	\$2411	\$2545
				46x63	\$2708	\$2844
				52x72	\$3065	\$3201
			Round	30D	\$1857	\$1994
				36D	\$2026	\$2162
				42D	\$2226	\$2361
			Oval	30x60	\$2325	\$2462
				36x72	\$2696	\$2833
				42x84	\$3134	\$3270
				48x96	\$3331	\$3469

To specify:
 Please refer to pages 3-4 for complete specifying information.
 Specify all products by their product code.

FLY TABLE

Design: Lievore Altherr Molina, licensed by Sellex

FLY6

Wood Veneer Top			TOP SHAPE	TOP SIZE	POWDERCOAT LEGS	POLISHED ALUMINUM LEGS		
H 29.5	Top Shape		Rectangle	30x60	\$2344	\$2482		
				36x72	\$2746	\$2882		
				42x84	\$3221	\$3358		
			L - Table		40x55	\$2545	\$2683	
					46x63	\$2903	\$3039	
					52x72	\$3330	\$3468	
			Round		30D	\$1909	\$2046	
					36D	\$2109	\$2247	
					42D	\$2347	\$2486	
			Oval		48D	\$2744	\$2881	
					30x60	\$2440	\$2578	
					36x72	\$2882	\$3018	
						42x84	\$3404	\$3543
						48x96	\$3660	\$3797

To specify:
 Please refer to pages 3-4 for complete specifying information.
 Specify all products by their product code.

Pricing Effective: January 2025

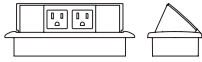

Power - Flip Top Grommet

LIST PRICE

2 - 110v, 1 USB

\$1199



Ganging

LIST PRICE

Links tops frontally or on the side

\$187



Textile Cable Tray

LIST PRICE

2 - 110v, 1 USB

\$187

Cable Duct

LIST PRICE

2 - 110v, 1 USB

\$187

To specify:
Please refer to pages 3-4 for
complete specifying information.
Specify all products by their
product code.



Front Divider Panel

LIST PRICE

W 47.25

\$997

Divider material is a rigid polyurethane, textured and laquered in your choice of Matte White, Black, or Grey.



Side Divider Panel

LIST PRICE

W 23.5

\$623

Divider material is a rigid polyurethane, textured and laquered in your choice of Matte White, Black, or Grey.

To specify:
Please refer to pages 3-4 for complete specifying information.
Specify all products by their product code.

Pricing Effective: January 2025

5695 Eagle Drive, SE
Grand Rapids,
Michigan 49512
616-975-9260
lelandfurniture.com

Gemma Occasional Table

January 2025 Price List



Gemma Occasional Table

Table of Contents	G02
Visual Reference	G03
Specification Information	G04
Specification Example	G05
Power Planning	G06
Sled Base	G07
Wood Base	G07
Totem Base	G08
Height Adjustable Base	G08

TABLE MODEL		TABLE TOP SIZES & BASE HEIGHT	BASE	PAGE
Sled Base (GETS)		32 DIA, 15H	Powder Coat	Page G07
		32 DIA, 18H		
		20 DIA, 22H		
		20 DIA, 26H		

TABLE MODEL		TABLE TOP SIZES	BASE	PAGE
Wood Base (GETW)		32 DIA, 15H	Birch	Page G07
		32 DIA, 18H	Walnut	
		20 DIA, 22H	Oak	
		20 DIA, 26H	Painted Wood	

TABLE MODEL		TABLE TOP SIZES	BASE	PAGE
Totem Base (GETT)		32 DIA, 15H	Powder Coat	Page G08
		32 DIA, 18H		
		20 DIA, 22H		
		20 DIA, 26H		

TABLE MODEL		TABLE TOP SIZES	BASE	PAGE
Height Adjustable (GETH)		32 DIA, 23-29H	Powder Coat	Page G08

Model

DESCRIPTION	CODE
Gemma occasional table, sled base	GETS
Gemma occasional table, wood base	GETW
Gemma occasional table, totem base	GETT
Gemma occasional table, height adjustable base	GETH

Top Size & Base Height

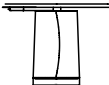
SLED BASE:

DESCRIPTION	CODE
32D, 15H	3215
32D, 18H	3218
20D, 22H	2022
20D, 26H	2026

WOOD BASE:

DESCRIPTION	CODE
32D, 15H	3215
32D, 18H	3218
20D, 22H	2022
20D, 26H	2026

TOTEM BASE:

DESCRIPTION	CODE
32D, 15H	3215
32D, 18H	3218
20D, 22H	2022
20D, 26H	2026

HEIGHT ADJUSTABLE BASE:

DESCRIPTION	CODE
32D, 23-29H	3229

Top Type

WOOD

DESCRIPTION	CODE
Birch	B
Oak	O
Walnut	W
Painted Wood	P

Top & Wood Base Finishes

*Wood bases default to specified top type except Painted Tops which pair with oak bases.

BIRCH FINISH OPTIONS

DESCRIPTION	CODE
Natural	11
Graphite	25
Transparent Black	29
White Wash II	30
Blue Sky	100M
Forest	101M
Sienna	106M
Willow	108M

OAK FINISH OPTIONS

DESCRIPTION	CODE
Natural White Oak	12
Morel	66M

WALNUT FINISH OPTIONS

DESCRIPTION	CODE
Natural Walnut	08M

TEXTURED PAINT (TOPS ONLY)

DESCRIPTION	CODE
White	WT
Black	BT

Sled & Totem Base Finishes

DESCRIPTION	CODE
Black	B
White	W
Black Textured	BT
White Textured	WT
Matte Mercury	MMR
Matte Mineral	MMN
Matte Burnish	MBN
Matte Foundry	MFN
Matte Blue Sky	MBS
Matte Forest	MFO
Matte Willow	MWL
Matte Sienna	MSN
Chrome (Sled Base Only)	C

Power Option

DESCRIPTION	CODE
Dual USB Unit	USB

*Available only on 22H and 26H Totem Base

Specifications required to create the product code

- Model
- Top Size
- Top Type
- Top Finish
- Base Height
- Base Finish



MODEL

Height Adjustable (GETH)

TOP SIZE

32 DIA (32)

TOP TYPE

Oak (0)

TOP FINISH

Natural White Oak (12)

BASE HEIGHT

23-29" (29)

BASE FINISH

Matte Willow Powder Coat (MWL)



Options

- Dual USB Unit (USB), standard cord

*Available only on 22H and 26H Totem Base



Dual USB



**Gemma Occasional Table,
Power Options**

	MODEL	LIST PRICE
Available on 22" Height and 26" Height Totem Base	USB Dual USB Unit	\$246



**Gemma Occasional Table,
Sled Base**

	MODEL		TEXTURED PAINT TOP	BIRCH TOP	OAK TOP	WALNUT TOP
32" DIA, Up Edge 15" Height	GETS-3215	Powder Coat	\$1249	N/A	1482	1607
	GETS-3215	Chrome	\$1444	N/A	1712	1855
32" DIA, Up Edge 18" Height	GETS-3218	Powder Coat	\$1309	N/A	1542	1666
	GETS-3218	Chrome	\$1504	N/A	1771	1915
20" DIA, Waterfall Edge 22" Height	GETS-2022	Powder Coat	\$797	846	904	959
	GETS-2022	Chrome	\$917	971	1038	1101
20" DIA, Waterfall Edge 26" Height	GETS-2026	Powder Coat	\$1071	1131	1309	1487
	GETS-2026	Chrome	\$1230	1300	1504	1711



**Gemma Occasional Table,
Wood Base**

	MODEL		TEXTURED PAINT TOP, OAK BASE	BIRCH TOP, BIRCH BASE	OAK TOP, OAK BASE	WALNUT TOP, WALNUT BASE
32" DIA, Up Edge 15" Height	GETW-3215	Wood Base	\$1416	N/A	1630	1761
32" DIA, Up Edge 18" Height	GETW-3218	Wood Base	\$1357	N/A	1571	1702
20" DIA, Waterfall Edge 22" Height	GETW-2022	Wood Base	\$839	887	947	1000
20" DIA, Waterfall Edge 26" Height	GETW-2026	Wood Base	\$1249	1309	1547	1785

To specify:
Please refer to pages 3-5 for complete specifying information.
Specify all products by their product code.

Pricing Effective: January 2025



Gemma Occasional Table,

Totem Base

	MODEL		TEXTURED PAINT TOP	BIRCH TOP	OAK TOP	WALNUT TOP
32" DIA, Up Edge 15" Height	GETT-3215	Powder Coat	\$1418	N/A	1597	1669
32" DIA, Up Edge 18" Height	GETT-3218	Powder Coat	\$1547	N/A	1725	1797
20" DIA, Waterfall Edge 22" Height	GETT-2022	Powder Coat	\$899	947	1119	1292
20" DIA, Waterfall Edge 26" Height	GETT-2026	Powder Coat	\$1607	1666	1815	1963

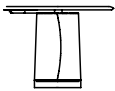

Gemma Occasional Table,

Height Adjustable

	MODEL		TEXTURED PAINT TOP	OAK TOP	WALNUT TOP
32" DIA, Waterfall Edge 23" - 29" Height Adjustable	GETH-3229	Powder Coat	\$3011	3189	3260

To specify:
 Please refer to pages 3-5 for complete specifying information.
 Specify all products by their product code.

Pricing Effective: January 2025

5695 Eagle Drive, SE
Grand Rapids,
Michigan 49512
616-975-9260
lelandfurniture.com

Gemma Stitch

January 2025 Price List



Gemma Stitch

Table of Contents	GS2
Specification Information	GS3
Specification Example	GS4
Gemma Stitch	GS5
Gemma Stitch Handle	GS5
Gemma Stitch Return Swivel	GS5

Chair Model

DESCRIPTION	CODE
Gemma Stitch	GEML

Upholstery Selection

Please refer to Leland Textile Program which features textiles and leathers from the following partners:

- Camira
- Green Hides
- Carnegie
- Maharam
- CF Stinson
- Unika Vaev

The complete grade list can be found at Leland's website or you can specify COM/COL. Due to the design of this product, it is recommended that all non pre-approved textile be tested for compatibility.

Optional

DESCRIPTION	CODE
Gemma Stitch Handle	GH
Gemma Stitch Return Swivel	RS

*Handle not available on return swivel base model

Product Weight

DESCRIPTION	LBS
Gemma Stitch Wood Base	39

Specifications required to create the product code

- Model
- Upholstery Selection
- Handle (If Applicable)



MODEL

Gemma Stitch (GEML)

UPHOLSTERY SELECTION

Enter upholstery grade or COM

GEMMA STITCH HANDLE

When applicable, enter GH



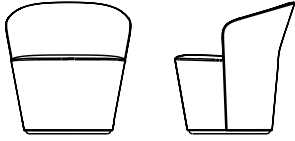

Gemma Stitch

MODEL	LIST PRICE/GRADE	COM/COL	A	B	C	D	E	F	G	H	I	J	K	L
GEML		\$2641	2806	2915	3024	3133	3242	3351	3460	3569	3678	3787	3896	4005

W 24.5 D 26 H 30 SH 18

COM Yardage: 3.25 yards

Contact Leland Customer Experience for yardage requirements on textiles with repeats.

For COL requirements please contact Leland Customer Experience.

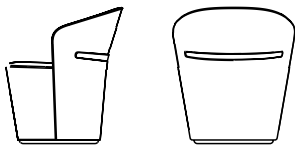

Gemma Stitch Handle

MODEL	LIST PRICE
GH	\$52

*Handle not available on return swivel base model

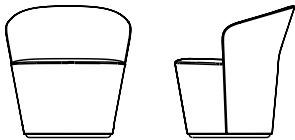

**Gemma Stitch,
Return Swivel Base**

MODEL	LIST PRICE/GRADE	COM/COL	A	B	C	D	E	F	G	H	I	J	K	L
GEML-RS		\$2773	2947	3060	3173	3286	3399	3512	3625	3738	3851	3964	4077	4190

W 24.5 D 26 H 30 SH 18

COM Yardage: 3.25 yards

Contact Leland Customer Experience for yardage requirements on textiles with repeats.

For COL requirements please contact Leland Customer Experience.

*Handle not available on return swivel base model

To specify:
Please refer to pages 3-4 for complete specifying information.
Specify all products by their product code.

**5695 Eagle Drive, SE
Grand Rapids,
Michigan 49512
616-975-9260
lelandfurniture.com**

Gemma Table

January 2025 Price List



Gemma Table

Table of Contents	GT2
Visual Reference	GT3
Specification Information	GT4
Specification Example	GT5
Power Planning	GT6
Totem Base	GT7
Wood Base	GT7

TABLE MODEL		TOP SIZES & HEIGHT	BASE	PAGE
Totem Base (GETT)		42 DIA, 29H 48 DIA, 29H	Powder Coat	Page GT7

TABLE MODEL		TOP SIZES & HEIGHT	BASE	PAGE
Wood Base, Round Top (GETD)		42 DIA, 29H 48 DIA, 29H	Beech Walnut Oak	Page GT7

TABLE MODEL		TOP SIZES & HEIGHT	BASE	PAGE
Wood Base, Soft Square Top (GETD)		42x42, 29H 48x48, 29H	Beech Walnut Oak	Page GT7

TABLE MODEL		TOP SIZES & HEIGHT	BASE	PAGE
Wood Base, Soft Rectangle Top (GETD)		60x36, 29H 72x36, 29H 84x42, 29H 96x42, 29H	Beech Walnut Oak	Page GT7

Model

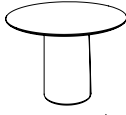
DESCRIPTION	CODE
Gemma table, totem base	GETT
Gemma table, wood base	GETD

Top Size & Base Height

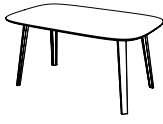
TOTEM BASE:

DESCRIPTION	CODE
42D, 29H	42D
48D, 29H	48D

WOOD BASE:

DESCRIPTION	CODE
42x42, 29H	4242
42D, 29H	42D
48x48, 29H	4848
48D, 29H	48D
60x36, 29H	6036
72x36, 29H	7236
84x42, 29H	8442
96x42, 29H	9642

Top Material

WOOD

DESCRIPTION	CODE
Beech	B
Oak	O
Walnut	W
Forbo	F
Laminate	L

Top & Wood Base Finishes

*Wood bases default to specified top type except Laminate and Forbo which pair with Beech bases, unless otherwise specified.

BEECH FINISH OPTIONS

DESCRIPTION	CODE
Natural	11
Graphite	25
Transparent Black	29
White Wash II	30
Blue Sky	100M
Forest	101M
Sienna	106M
Willow	108M

OAK FINISH OPTIONS

DESCRIPTION	CODE
Natural White Oak	12
Morel	66M

WALNUT FINISH OPTIONS

DESCRIPTION	CODE
Natural Walnut	08M

FORBO FINISH OPTIONS

DESCRIPTION	CODE
Smokey Blue	4179
Powder	4185
Pebble	4175
Olive	4184
Mauve	4172

LAMINATE FINISH OPTIONS

DESCRIPTION	CODE
Platinum Wilsonart® (D315-60)	LGP
Black Pionite® (SE101)	LBK
White Wilsonart® (D354-60)	LWH

Totem Base Finishes

DESCRIPTION	CODE
Black	B
White	W
Black Textured	BT
White Textured	WT
Matte Mercury	MMR
Matte Mineral	MMN
Matte Burnish	MBN
Matte Foundry	MFN
Matte Blue Sky	MBS
Matte Forest	MFO
Matte Willow	MWL
Matte Sienna	MSN

Power Option

1 Simplex, 1 USB A+C

DESCRIPTION	CODE
Edge Mounted, White	PEM-W
Edge Mounted, Black	PEM-B
In-Surface, White	PIS-W
In-Surface, Black	PIS-B

*Totem base models with power must choose from in-surface power options

Edge Types

DESCRIPTION	CODE
Wood Edge	W7
Flat PVC Edge	V6

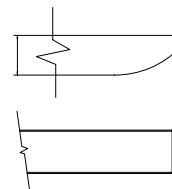

*W7 edge on Beech, Oak, Walnut, and Forbo tops only.

^V6 edge on Laminate tops only.

Specifications required to create the product code

- Model
- Top Size
- Top Type
- Top Finish
- Base Finish
- Power Option (Optional)



MODEL

Gemma Table, Wood Base (GETD)

TOP SIZE

42 DIA (42D)

TOP TYPE

Oak (0)

TOP FINISH

Natural White Oak (12)

BASE HEIGHT

29 Inches

BASE FINISH

Natural White Oak (12)



Options

- 1 Simplex, 1 USB A+C, braided cord
- Edge Mounted and In-Surface options available on Wood Base Models
- In-Surface options available on Totem Base Models
- Cord Length: Differs based on table size. All tables will have approximately 2' of additional cord from the base of the leg.

Edge Mounted Power



Wire Management



In-Surface Power

**Gemma Table,
Power Options**

	MODEL	LIST PRICE
1 Simplex, 1 USB A+C Braided Cord	PEM-W Edge Mounted, White	\$195
	PEM-B Edge Mounted, Black	\$195
	PIS-W In-Surface, White	\$303
	PIS-B In Surface, Black	\$303

*Edge Mounted Power located 3 inches from edge of table leg

GEMMA TABLE
Design: Altherr Désile Park

GT7

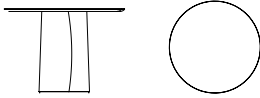

**Gemma Table,
Totem Base**

	MODEL	BASE	LAMINATE TOP	BEECH TOP	OAK TOP	WALNUT TOP	FORBO TOP
42" DIA, 29" Height	GETT-42D	Powder Coat	\$4202	4508	4612	4612	4612
48" DIA, 29" Height	GETT-48D	Powder Coat	\$4576	4880	4985	4985	4985

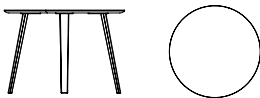

**Gemma Table,
Wood Base**

	MODEL	BASE	LAMINATE TOP	BEECH TOP	OAK TOP	WALNUT TOP	FORBO TOP
42" DIA, 29" Height	GETD-42D	Wood Base	\$3481	3787	3889	3889	3889
48" DIA, 29" Height	GETD-48D	Wood Base	\$3855	4161	4266	4266	4266

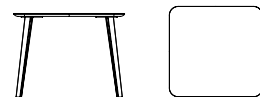

**Gemma Table,
Wood Base**

	MODEL	BASE	LAMINATE TOP	BEECH TOP	OAK TOP	WALNUT TOP	FORBO TOP
42"x42", 29" Height	GETD-4242	Wood Base	\$3481	3787	3787	3889	3889
48"x48", 29" Height	GETD-4848	Wood Base	\$3855	4161	4161	4266	4266



**Gemma Table,
Wood Base**

	MODEL	BASE	LAMINATE TOP	BEECH TOP	OAK TOP	WALNUT TOP	FORBO TOP
60"x36", 29" Height	GETD-6036	Wood Base	\$4286	4592	4697	4697	4697
72"x36", 29" Height	GETD-7236	Wood Base	\$4719	5024	5126	5126	5126
84"x42", 29" Height	GETD-8442	Wood Base	\$5492	5797	5900	5900	5900
96"x42", 29" Height	GETD-9642	Wood Base	\$5620	5926	6029	6029	6029

To specify:

Please refer to pages 3-5 for complete specifying information.

Specify all products by their product code.

Pricing Effective: January 2025

5695 Eagle Drive, SE
Grand Rapids,
Michigan 49512
616-975-9260
lelandfurniture.com

Gemma

January 2025 Price List



Gemma

Table of Contents	GM2
Specification Information	GM3
Specification Example	GM4
Sled Base, Birch Shell	GM5
Sled Base, Oak Shell	GM6
Sled Base, Walnut Shell	GM7
Wood Base, Birch	GM8
Wood Base, Oak	GM9
Wood Base, Walnut	GM10
Task Base, Birch Shell	GM11
Task Base, Oak Shell	GM12
Task Base, Walnut Shell	GM13

Chair Model

DESCRIPTION	CODE
Gemma sled base	GEMS
Gemma sled base, upholstered seat	GEMSU
Gemma sled base, upholstered seat and back	GEMSUU
Gemma wood base	GEMW
Gemma wood base, upholstered seat	GEMWU
Gemma wood base, upholstered seat and back	GEMWUU
Gemma task base	GEMT
Gemma task base, upholstered seat	GEMTU
Gemma task base, upholstered seat and back	GEMTUU

Shell Veneer

DESCRIPTION	CODE
Birch	B
Oak	O
Walnut	W

Wood Shell & Wood Base Finishes

*Wood bases default to specified shell type

STANDARD SHELL/LEG (BIRCH):

DESCRIPTION	CODE
Natural	11
Graphite	25
Transparent Black	29
White Wash II	30
Forest	101M
Willow	108M

OAK SHELL/LEG:

DESCRIPTION	CODE
Natural White Oak	12
Morel	66M
Evergreen	112M
Sienna	113M
Blue Sky	114M

WALNUT SHELL/LEG:

DESCRIPTION	CODE
Natural Walnut	08M

Sled and Task Base Finishes

DESCRIPTION	CODE
Black	B
White	W
Black Textured	BT
White Textured	WT
Matte Mercury	MMR
Matte Mineral	MMN
Matte Burnish	MBN
Matte Foundry	MFN
Matte Blue Sky	MBS
Matte Forest	MFO
Matte Willow	MWL
Matte Sienna	MSN
Matte Pine	MPN
Chrome	C

Upholstery Selection

Please refer to Leland Textile Program which features textiles and leathers from the following partners:

- Camira
- Green Hides
- Carnegie
- Maharam
- CF Stinson
- Unika Vaev

The complete grade list can be found on our website or you can specify COM/COL. Due to the design of this product, it is recommended that all non pre-approved textile be tested for compatibility.

Glide Type

STANDARD:

DESCRIPTION	CODE
Nylon	S

OPTIONAL:

DESCRIPTION	CODE
Felt	FC

Caster Options

DESCRIPTION	CODE
Gemma task base	
Hard Floor	HF
Soft Floor	SF

Stacking note

The Gemma chair does not stack.

Specifications required to create the product code

- Model
- Wood Species
- Shell Finish
- Seat upholstery selection (when applicable)
- Leg Finish
- Back Upholstery Selection (when applicable)
- Glide Type



MODEL

Gemma Wood Base Chair (GEMW)

WOOD SPECIES

Oak (0)

SHELL FINISH

Natural White Oak (12)

SEAT UPHOLSTERY SELECTION

When applicable, enter upholstery grade, COM

LEG FINISH

Natural White Oak (12)

SEAT AND/OR BACK UPHOLSTERY SELECTION

When applicable, enter upholstery grade, COM



GEMMA SLED BASE CHAIR, BIRCH SHELL
 Design: Altherr Désile Park

GM5



Gemma Sled Base Chair				MODEL	LIST PRICE
Birch shell				GEMS-B Powder Coat	\$1025
W 22	D 22.75	H 30.25	SH 17.75	Chrome	\$1087

Optional Felt Glides: Add \$8.00 net per chair for a set of four (4).



Gemma Sled Base Chair				MODEL	LIST PRICE/GRADE	COM/COL	A	B	C	D	E	F	G	H	I	J	K	L
Birch shell, upholstered seat				GEMSU-B	Powder Coat	\$1154	1203	1227	1251	1275	1299	1323	1347	1371	1395	1419	1443	1467
W 22	D 22.75	H 30.25	SH 17.75		Chrome	\$1215	1263	1288	1313	1338	1363	1388	1413	1438	1463	1488	1513	1538

Optional Felt Glides: Add \$8.00 net per chair for a set of four (4).
 COM Yardage: 1 seat: .75 yard
 Contact Leland Customer Experience for yardage requirements on textiles with repeats.
 For COL requirements please contact Leland Customer Experience.



Gemma Sled Base Chair				MODEL	LIST PRICE/GRADE	COM/COL	A	B	C	D	E	F	G	H	I	J	K	L
Birch shell, upholstered seat and back				GEMSUU-B	Powder Coat	\$1288	1348	1405	1462	1519	1576	1633	1690	1747	1804	1861	1918	1975
W 22	D 22.75	H 30.25	SH 17.75		Chrome	\$1349	1407	1466	1525	1584	1643	1702	1761	1820	1879	1938	1997	2056

Optional Felt Glides: Add \$8.00 net per chair for a set of four (4).
 COM Yardage: 1 seat: 1.25 yards
 Contact Leland Customer Experience for yardage requirements on textiles with repeats.
 For COL requirements please contact Leland Customer Experience.
 Due to the curvature of the chair shell, we are not able to pattern match on the chair back and seat. If a directional fabric is being specified, add \$56 LIST for a pattern match in the center of the seat and back only.

To specify:
 Please refer to pages 3-4 for complete specifying information.
 Specify all products by their product code.

Pricing Effective: January 2025

GEMMA SLED BASE CHAIR, OAK SHELL
 Design: Altherr Désile Park

GM6



Gemma Sled Base Chair				MODEL		LIST PRICE
Oak shell				GEMS-O	Powder Coat	\$1164
W 22	D 22.75	H 30.25	SH 17.75		Chrome	\$1226

Optional Felt Glides: Add \$8.00 net per chair for a set of four (4).



Gemma Sled Base Chair				MODEL	LIST PRICE/GRADE	COM/COL	A	B	C	D	E	F	G	H	I	J	K	L
Oak shell, upholstered seat				GEMSU-O	Powder Coat	\$1293	1341	1366	1391	1416	1441	1466	1491	1516	1541	1566	1591	1616
W 22	D 22.75	H 30.25	SH 17.75		Chrome	\$1354	1402	1427	1452	1477	1502	1527	1552	1577	1602	1627	1652	1677

Optional Felt Glides: Add \$8.00 net per chair for a set of four (4).
 COM Yardage: 1 seat: .75 yard
 Contact Leland Customer Experience for yardage requirements on textiles with repeats.
 For COL requirements please contact Leland Customer Experience.



Gemma Sled Base Chair				MODEL	LIST PRICE/GRADE	COM/COL	A	B	C	D	E	F	G	H	I	J	K	L
Oak shell, upholstered seat and back				GEMSUU-O	Powder Coat	\$1427	1487	1544	1601	1658	1715	1772	1829	1886	1943	2000	2057	2114
W 22	D 22.75	H 30.25	SH 17.75		Chrome	\$1488	1547	1605	1663	1721	1779	1837	1895	1953	2011	2069	2127	2185

Optional Felt Glides: Add \$8.00 net per chair for a set of four (4).
 COM Yardage: 1 seat: 1.25 yards
 Contact Leland Customer Experience for yardage requirements on textiles with repeats.
 For COL requirements please contact Leland Customer Experience.
 Due to the curvature of the chair shell, we are not able to pattern match on the chair back and seat. If a directional fabric is being specified, add \$56 LIST for a pattern match in the center of the seat and back only.

To specify:
 Please refer to pages 3-4 for complete specifying information.
 Specify all products by their product code.

Pricing Effective: January 2024

GEMMA SLED BASE CHAIR, WALNUT SHELL
 Design: Altherr Désile Park

GM7



Gemma Sled Base Chair				MODEL		LIST PRICE
Walnut shell				GEMS-B	Powder Coat	\$1360
W 22	D 22.75	H 30.25	SH 17.75		Chrome	\$1421

Optional Felt Glides: Add \$8.00 net per chair for a set of four (4).



Gemma Sled Base Chair				MODEL	LIST PRICE/GRADE	COM/COL	A	B	C	D	E	F	G	H	I	J	K	L
Walnut shell, upholstered seat				GEMSU-B	Powder Coat	\$1488	1536	1561	1586	1611	1636	1661	1686	1711	1736	1761	1786	1811
W 22	D 22.75	H 30.25	SH 17.75		Chrome	\$1549	1598	1622	1646	1670	1694	1718	1742	1766	1790	1814	1838	1862

Optional Felt Glides: Add \$8.00 net per chair for a set of four (4).
 COM Yardage: 1 seat: .75 yard
 Contact Leland Customer Experience for yardage requirements on textiles with repeats.
 For COL requirements please contact Leland Customer Experience.



Gemma Sled Base Chair				MODEL	LIST PRICE/GRADE	COM/COL	A	B	C	D	E	F	G	H	I	J	K	L
Walnut shell, upholstered seat and back				GEMSUU-B	Powder Coat	\$1621	1681	1739	1797	1855	1913	1971	2029	2087	2145	2203	2261	2319
W 22	D 22.75	H 30.25	SH 17.75		Chrome	\$1683	1742	1800	1858	1916	1974	2032	2090	2148	2206	2264	2322	2380

Optional Felt Glides: Add \$8.00 net per chair for a set of four (4).
 COM Yardage: 1 seat: 1.25 yards
 Contact Leland Customer Experience for yardage requirements on textiles with repeats.
 For COL requirements please contact Leland Customer Experience.
 Due to the curvature of the chair shell, we are not able to pattern match on the chair back and seat. If a directional fabric is being specified, add \$56 LIST for a pattern match in the center of the seat and back only.

To specify:
 Please refer to pages 3-4 for complete specifying information.
 Specify all products by their product code.

Pricing Effective: January 2025

GEMMA WOOD BASE CHAIR, BIRCH
Design: Altherr Désile Park

GM8



Gemma Wood Base Chair				MODEL	LIST PRICE
Birch shell/base				GEMW-B	\$1304
W 22	D 21	H	SH 18	Optional Felt Glides: Add \$8.00 net per chair for a set of four (4).	



Gemma Wood Base Chair				MODEL	LIST PRICE/GRADE	COM/COL	A	B	C	D	E	F	G	H	I	J	K	L	
Birch shell/base, upholstered seat				GEMWU-B	\$1432	1481	1506	1531	1556	1581	1606	1631	1656	1681	1706	1731	1756		
W 22				D 21	H	SH 18	Optional Felt Glides: Add \$8.00 net per chair for a set of four (4).												
				COM Yardage: 1 seat: .75 yard															
				Contact Leland Customer Experience for yardage requirements on textiles with repeats.															
				For COL requirements please contact Leland Customer Experience.															



Gemma Wood Base Chair				MODEL	LIST PRICE/GRADE	COM/COL	A	B	C	D	E	F	G	H	I	J	K	L	
Birch shell/base, upholstered seat and back				GEMWUU-B	\$1554	1614	1672	1730	1788	1846	1904	1962	2020	2078	2136	2194	2252		
W 22				D 21	H	SH 18	Optional Felt Glides: Add \$8.00 net per chair for a set of four (4).												
				COM Yardage: 1 seat: 1.25 yards															
				Contact Leland Customer Experience for yardage requirements on textiles with repeats.															
				For COL requirements please contact Leland Customer Experience.															
				Due to the curvature of the chair shell, we are not able to pattern match on the chair back and seat. If a directional fabric is being specified, add \$56 LIST for a pattern match in the center of the seat and back only.															

To specify:
Please refer to pages 3-4 for complete specifying information.
Specify all products by their product code.

GEMMA WOOD BASE CHAIR, OAK
Design: Altherr Désile Park

GM9



Gemma Wood Base Chair				MODEL	LIST PRICE
Oak shell/base				GEMW-0	\$1443
W 22	D 21	H	SH 18	Optional Felt Glides: Add \$8.00 net per chair for a set of four (4).	



Gemma Wood Base Chair				MODEL	LIST PRICE/GRADE	COM/COL	A	B	C	D	E	F	G	H	I	J	K	L
Oak shell/base, upholstered seat				GEMWU-0	\$1572		1620	1645	1670	1695	1720	1745	1770	1795	1820	1845	1870	1895
W 22	D 21	H	SH 18	Optional Felt Glides: Add \$8.00 net per chair for a set of four (4).														
				COM Yardage: 1 seat: .75 yard														
				Contact Leland Customer Experience for yardage requirements on textiles with repeats.														
				For COL requirements please contact Leland Customer Experience.														



Gemma Wood Base Chair				MODEL	LIST PRICE/GRADE	COM/COL	A	B	C	D	E	F	G	H	I	J	K	L
Oak shell/base, upholstered seat and back				GEMWUU-0	\$1706		1764	1823	1882	1941	2000	2059	2118	2177	2236	2295	2354	2413
W 22	D 21	H	SH 18	Optional Felt Glides: Add \$8.00 net per chair for a set of four (4).														
				COM Yardage: 1 seat: 1.25 yards														
				Contact Leland Customer Experience for yardage requirements on textiles with repeats.														
				For COL requirements please contact Leland Customer Experience.														
				Due to the curvature of the chair shell, we are not able to pattern match on the chair back and seat. If a directional fabric is being specified, add \$56 LIST for a pattern match in the center of the seat and back only.														

To specify:
Please refer to pages 3-4 for complete specifying information.
Specify all products by their product code.

Pricing Effective: January 2025

GEMMA WOOD BASE CHAIR, WALNUT
 Design: Altherr Désile Park

GM10



Gemma Wood Base Chair		MODEL	LIST PRICE
Walnut shell/base		GEMW-B	\$1639
W 22	D 21	H	SH 18
Optional Felt Glides: Add \$8.00 net per chair for a set of four (4).			



Gemma Wood Base Chair		MODEL	LIST PRICE/GRADE	COM/COL	A	B	C	D	E	F	G	H	I	J	K	L	
Walnut shell/base, upholstered seat		GEMWU-B	Powder Coat	\$1765	1815	1840	1865	1890	1915	1940	1965	1990	2015	2040	2065	2090	
W 22		D 21	H	SH 18	Optional Felt Glides: Add \$8.00 net per chair for a set of four (4).												
		COM Yardage: 1 seat: .75 yard															
		Contact Leland Customer Experience for yardage requirements on textiles with repeats.															
		For COL requirements please contact Leland Customer Experience.															



Gemma Wood Base Chair		MODEL	LIST PRICE/GRADE	COM/COL	A	B	C	D	E	F	G	H	I	J	K	L	
Walnut shell/base, upholstered seat and back		GEMWUU-B	Powder Coat	\$1899	1959	2018	2077	2136	2195	2254	2313	2372	2431	2490	2549	2608	
W 22		D 21	H	SH 18	Optional Felt Glides: Add \$8.00 net per chair for a set of four (4).												
		COM Yardage: 1 seat: 1.25 yards															
		Contact Leland Customer Experience for yardage requirements on textiles with repeats.															
		For COL requirements please contact Leland Customer Experience.															
		Due to the curvature of the chair shell, we are not able to pattern match on the chair back and seat. If a directional fabric is being specified, add \$56 LIST for a pattern match in the center of the seat and back only.															

To specify:
 Please refer to pages 3-4 for complete specifying information.
 Specify all products by their product code.

Pricing Effective: January 2025

GEMMA TASK BASE CHAIR, BIRCH SHELL
 Design: Altherr Désile Park

GM11

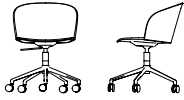

Gemma Task Base Chair			MODEL	LIST PRICE
Birch shell			GEMT-B Black Textured	\$1394
W 22	D 25.25	H 28.25 - 31	Powder Coat	\$1530
SH 15.75 - 18.5				

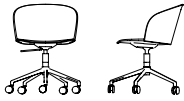

Gemma Task Base Chair			MODEL	LIST PRICE/GRADE	COM/COL	A	B	C	D	E	F	G	H	I	J	K	L
Birch shell, upholstered seat			GEMTU-B	Black Textured	\$1511	1561	1585	1609	1633	1657	1681	1705	1729	1753	1777	1801	1825
W 22	D 25.25	H 28.25 - 31		Powder Coat	\$1647	1696	1721	1746	1771	1796	1821	1846	1871	1896	1921	1946	1971
SH 15.75 - 18.5			COM Yardage: 1 seat: .75 yard														
Contact Leland Customer Experience for yardage requirements on textiles with repeats.																	
For COL requirements please contact Leland Customer Experience.																	

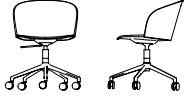

Gemma Task Base Chair			MODEL	LIST PRICE/GRADE	COM/COL	A	B	C	D	E	F	G	H	I	J	K	L
Birch shell, upholstered seat and back			GEMTUU-B	Black Textured	\$1661	1721	1780	1839	1898	1957	2016	2075	2134	2193	2252	2311	2370
				Powder Coat	\$1797	1857	1916	1975	2034	2093	2152	2211	2270	2329	2388	2447	2506
SH 15.75 - 18.5			COM Yardage: 1 seat: 1.25 yard														
Contact Leland Customer Experience for yardage requirements on textiles with repeats.																	
For COL requirements please contact Leland Customer Experience.																	
Due to the curvature of the chair shell, we are not able to pattern match on the chair back and seat. If a directional fabric is being specified, add \$56 LIST for a pattern match in the center of the seat and back only.																	

To specify:
 Please refer to pages 3-4 for complete specifying information.
 Specify all products by their product code.

GEMMA TASK BASE CHAIR, OAK SHELL
 Design: Altherr Désile Park

GM12

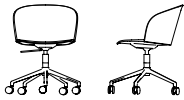

Gemma Task Base Chair		MODEL	LIST PRICE
Oak shell		GEMT-O Black Textured	\$1454
W 22	D 25.25 H 28.25 - 31	Powder Coat	\$1589
SH 15.75 - 18.5			

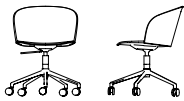

Gemma Task Base Chair		MODEL	LIST PRICE/GRADE	COM/COL	A	B	C	D	E	F	G	H	I	J	K	L
Oak shell, upholstered seat		GEMTU-O	Black Textured	\$1572	1621	1646	1671	1696	1721	1746	1771	1796	1821	1846	1871	1896
W 22	D 25.25 H 28.25 - 31		Powder Coat	\$1708	1757	1782	1807	1832	1857	1882	1907	1932	1957	1982	2007	2032
SH 15.75 - 18.5		COM Yardage: 1 seat: .75 yard														
Contact Leland Customer Experience for yardage requirements on textiles with repeats.																
For COL requirements please contact Leland Customer Experience.																

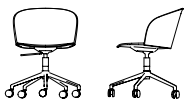

Gemma Task Base Chair		MODEL	LIST PRICE/GRADE	COM/COL	A	B	C	D	E	F	G	H	I	J	K	L
Oak shell, upholstered seat and back		GEMTUU-O	Black Textured	\$1722	1782	1841	1900	1959	2018	2077	2136	2195	2254	2313	2372	2431
			Powder Coat	\$1858	1918	1976	2034	2092	2150	2208	2266	2324	2382	2440	2498	2556
SH 15.75 - 18.5		COM Yardage: 1 seat: 1.25 yard														
Contact Leland Customer Experience for yardage requirements on textiles with repeats.																
For COL requirements please contact Leland Customer Experience.																
Due to the curvature of the chair shell, we are not able to pattern match on the chair back and seat. If a directional fabric is being specified, add \$56 LIST for a pattern match in the center of the seat and back only.																

To specify:
 Please refer to pages 3-4 for complete specifying information.
 Specify all products by their product code.

Pricing Effective: January 2025

GEMMA TASK BASE CHAIR, WALNUT SHELL
 Design: Altherr Désile Park

GM13

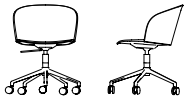

Gemma Task Base Chair		MODEL	LIST PRICE
Walnut shell		GEMT-B Black Textured	\$1501
W 22	D 25.25 H 28.25 - 31	Powder Coat	\$1637
SH 15.75 - 18.5			

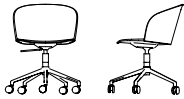

Gemma Task Base Chair		MODEL	LIST PRICE/GRADE	COM/COL	A	B	C	D	E	F	G	H	I	J	K	L
Walnut shell, upholstered seat		GEMTU-B	Black Textured	\$1618	1668	1692	1716	1740	1764	1788	1812	1836	1860	1884	1908	1932
W 22	D 25.25 H 28.25 - 31		Powder Coat	\$1753	1802	1827	1852	1877	1902	1927	1952	1977	2002	2027	2052	2077
SH 15.75 - 18.5		COM Yardage: 1 seat: .75 yard														
Contact Leland Customer Experience for yardage requirements on textiles with repeats.																
For COL requirements please contact Leland Customer Experience.																

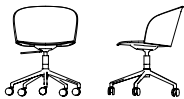

Gemma Task Base Chair		MODEL	LIST PRICE/GRADE	COM/COL	A	B	C	D	E	F	G	H	I	J	K	L
Walnut shell, upholstered seat and back		GEMTUU-B	Black Textured	\$1770	1829	1888	1947	2006	2065	2124	2183	2242	2301	2360	2419	2478
			Powder Coat	\$1904	1964	2023	2082	2141	2200	2259	2318	2377	2436	2495	2554	2613
		COM Yardage: 1 seat: 1.25 yard														
		Contact Leland Customer Experience for yardage requirements on textiles with repeats.														
		For COL requirements please contact Leland Customer Experience.														
		Due to the curvature of the chair shell, we are not able to pattern match on the chair back and seat. If a directional fabric is being specified, add \$56 LIST for a pattern match in the center of the seat and back only.														

To specify:
 Please refer to pages 3-4 for complete specifying information.
 Specify all products by their product code.

Pricing Effective: January 2025

5695 Eagle Drive, SE
Grand Rapids,
Michigan 49512
616-975-9260
lelandfurniture.com

Geode

January 2025 Price List



Geode

Table of Contents	GD2
Specification Information	GD3
Specification Example	GD4
Geode Lounge	GD5
Swivel Base	GD6

Chair Model

DESCRIPTION	CODE
Geode Lounge	GDL

Upholstery Selection

Please refer to Leland Textile Program which features textiles and leathers from the following partners:

- [Pre-approved Textiles](#)

The complete grade list can be found at Leland’s website or you can specify COM/COL. Due to the design of this product, it is recommended that all non pre-approved textile be tested for compatibility.

Due to upholstery requirements, the Geode can only be upholstered railroaded. Please consider when specifying textiles with a pattern

Auxiliary

DESCRIPTION	CODE
Power Right Hand Side	PWRR
Power Left Hand Side	PWRL
USB Right Hand Side	USBR
USB Left Hand Side	USBL

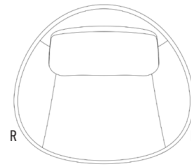

*Only available on stationary base

AUXILIARY COLOR OPTIONS:

Black	B
Gray	GY

RETURN SWIVEL BASE	RS
--------------------	----

Product Weight

DESCRIPTION	LBS
Geode Lounge	90

Specifications required to create the product code

- Model
- Upholstery Selection
- Auxiliary



MODEL

Geode (GDL)

UPHOLSTERY SELECTION

Enter upholstery grade or COM



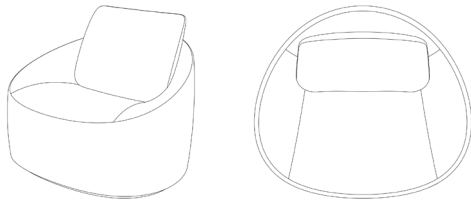

Geode Lounge

			MODEL	LIST PRICE/GRADE	COM/COL	A	B	C	D	E	F	G	H	I	J	K	L
W 38.39	D 34.06	H 30	GDL		\$2930	\$3170	\$3291	\$3412	\$3533	\$3654	\$3775	\$3896	\$4017	\$4138	\$4259	\$4380	\$4501

SH 18

COM Yardage: 6 yards

Contact Leland Customer Experience for yardage requirements on textiles with repeats.

For COL requirements please contact Leland Customer Experience.



Power Receptacle

	MODEL		LIST PRICE
Black (B), Gray (GY)	PWRR	Power Right Hand Side	\$243
Dia 2 7/8"	PWRL	Power Left Hand Side	\$243

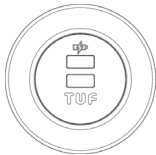

Dual USB Charge

	MODEL		LIST PRICE
Black (B), Gray (GY)	USBR	USB Right Hand Side	\$355
Dia 2 7/8"	USBL	USB Left Hand Side	\$355

To specify:

Please refer to pages 3-4 for complete specifying information.

Specify all products by their product code.

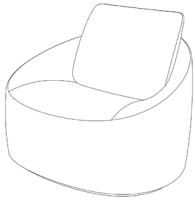

**Geode,
 Return Swivel Base**

			MODEL	LIST PRICE/GRADE	COM/COL	A	B	C	D	E	F	G	H	I	J	K	L
W 38.39	D 34.06	H 30	GDL-RS		\$3487	\$3727	\$3848	\$3969	\$4090	\$4211	\$4332	\$4453	\$4574	\$4695	\$4816	\$4937	\$5058

SH 18

COM Yardage: 6 yards

Contact Leland Customer Experience for yardage requirements on textiles with repeats.

For COL requirements please contact Leland Customer Experience.

To specify:
 Please refer to pages 3-4 for complete specifying information.
 Specify all products by their product code.

5695 Eagle Drive, SE
Grand Rapids,
Michigan 49512
616-975-9260
lelandfurniture.com

Hammok

January 2025 Price List



Hammok

Table of Contents	HS2
Specification Information	HS3
Specification Example	HS4
Cantilever Chair	HS5
Cantilever Chair, Upholstered Onlay	HS5

Chair Model

DESCRIPTION	CODE
Hammok cantilever chair	HC
Hammok cantilever chair, upholstered onlay	HCU

Shell Finish

STANDARD LELAND COLORS

CUSTOM Specify Custom (01)

*Please note that Hammok is NOT AVAILABLE in the following finishes:
 Natural Walnut Matte (08M), Natural (11), Natural White Oak Matte (12M)

Frame Finish

DESCRIPTION	CODE
Sterling	ST
Warm Grey	WG
Cool Grey	CG
Black	B
White	W
Matte Mercury	MMR
Matte Mineral	MMN
Matte Burnish	MBN
Matte Foundry	MFN

Brushed Stainless Steel (Cantilever only) BSS

TEXTURED	CODE
Dolphin Textured	DLT
Oxford Textured	OXT
Black Textured	BT
White Textured	WT
Matte Blue Sky	MBS
Matte Forest	MFO
Matte Sienna	MSN
Matte Willow	MWL

Upholstered Onlay Selection

Please refer to Leland Textile Program which features textiles and leathers from the following partners:

- Camira
- Carnegie
- CF Stinson
- Green Hides
- Maharam
- Unika Vaev

The complete grade list can be found on our website or you can specify COM/COL. Due to the design of this product, it is recommended that all non pre-approved textile be tested for compatibility.

Arm Finish

Black molded ABS

Glide Type

STANDARD

DESCRIPTION	CODE
Nylon (Cantilever only)	S

Freight Note

Due to the size and nature of Hammok chairs, the Freight Program does not apply to this product. Please contact Customer Experience for a quote.

Specifications required to create the product code

- Model
- Shell Finish
- Frame Finish
- Upholstered Onlay Selection (when applicable)
- Glide Type



MODEL

Hammok Cantilever,
upholstered onlay (HCU)

SHELL FINISH

Natural (11)

FRAME FINISH

Sterling (ST)

UPHOLSTERED ONLAY SELECTION

When applicable, enter
upholstery grade, COM or COL.
Grade J (J)



HAMMOK CANTILEVER CHAIR
Design: Burkhard Vogtherr

HS5

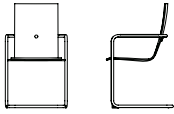

Hammok Cantilever Chair	MODEL	LIST PRICE
Powder coat frame	HC - ___	\$1078
W 22 D 22 H 34.5		
SH 17.75 AH 25.875		

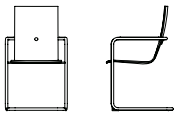

Hammok Cantilever Chair	MODEL	LIST PRICE
Brushed stainless steel frame	HC-BSS	\$1298
W 22 D 22 H 34.5		
SH 17.75 AH 25.875		

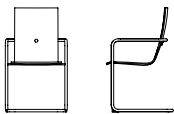

Hammock Cantilever	MODEL	LIST PRICE/GRADE	COM/COL	A	B	C	D	E	F	G	H	I	J	K	L
Powder coat frame, upholstered onlay	HCU	\$1164	1232	1266	1300	1334	1368	1402	1436	1470	1504	1538	1572	1606	
W 22 D 22 H 34.5															
SH 17.75 AH 25.875															
		COM Yardage: 1 or 2 chairs: 1.25 yards: 3 or 4 chairs: 2.5 yards													
		Contact Leland Customer Experience for yardage requirements on textiles with repeats.													
		For COL requirements please contact Leland Customer Experience.													

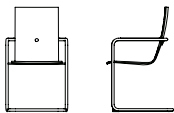

Hammock Cantilever	MODEL	LIST PRICE/GRADE	COM/COL	A	B	C	D	E	F	G	H	I	J	K	L
Brushed stainless steel frame, upholstered onlay	HCU-BSS	\$1527	1595	1629	1663	1697	1731	1765	1799	1833	1867	1901	1935	1969	
W 22 D 22 H 34.5															
SH 17.75 AH 25.875															
		COM Yardage: 1 or 2 chairs: 1.25 yards: 3 or 4 chairs: 2.5 yards													
		Contact Leland Customer Experience for yardage requirements on textiles with repeats.													
		For COL requirements please contact Leland Customer Experience.													

To specify:
Please refer to pages 3-4 for complete specifying information.
Specify all products by their product code.

Pricing Effective: January 2025

5695 Eagle Drive, SE
Grand Rapids,
Michigan 49512
616-975-9260
lelandfurniture.com

Handy Stool

January 2025 Price List



Handy Stool

Table of contents	HA2
Specification Information	HA3
Specification Example	HA4
Handy Stool	HA5
Transport/Stacking Dolly	HA8

Model

DESCRIPTION	CODE
Handy Polypropylene	HYS-P
Handy Polypropylene Shell, Upholstered Onlay	HYS-U
Handy Polypropylene Shell, Wood Onlay	HYS-W
Handy Stool Transport Dolly, Single	HYD-S
Handy Stool Transport Dolly, Double	HYD-D

Shell Finish/Color

POLYPROPYLENE SHELL:

DESCRIPTION	CODE
White	WT
Recycled Black	RB
Grey	G
Pistachio	PS
Fawn	FW

CUSTOM POLYPROPYLENE COLORS

Custom color match is available upon request. Please contact hello@lelandfurniture.com for further information.

Upholstered Onlay Selection

Please refer to Leland Textile Program which features textiles and leathers from the following partners:

- Camira
- Carnegie
- CF Stinson
- Green Hides
- Maharam
- Unika Vaev

The complete grade list can be found on our website or you can specify COM/COL. Due to the design of this product, it is recommended that all non pre-approved textiles be tested for compatibility.

Wood Onlay Selection

DESCRIPTION	CODE
Natural Walnut	08M
Natural White Oak	12

LELAND COLORS (on maple)

Stacking Note

For Handy, ALL models stack as follows: (including upholstered and wood onlay)



Stack of 10: 44"H
Stack of 5: 29.5"H

Product Weight

DESCRIPTION	LBS
Handy Polypropylene - HYS-P	7
Handy Polypropylene Shell, Upholstered Onlay - HYS-U	8
Handy Polypropylene Shell, Wood Onlay - HYS-W	8

Specifications required to create the product code

- Model
- Shell Finish
- Wood Finish Species (when applicable)
- Wood Finish Code (when applicable)
- Upholstery Option (when applicable)

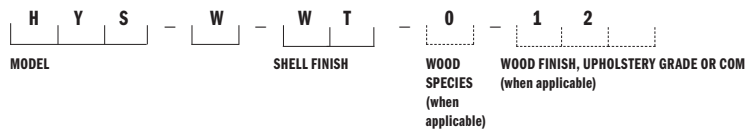

MODEL

Handy Stool (HYS)

ONLAY SELECTION

Wood (W)

SPECIES

Natural White Oak (12)

UPHOLSTERED ONLAY SELECTION

When applicable, enter upholstery grade, COM

POLYPROPYLENE SHELL FINISH

White (W)

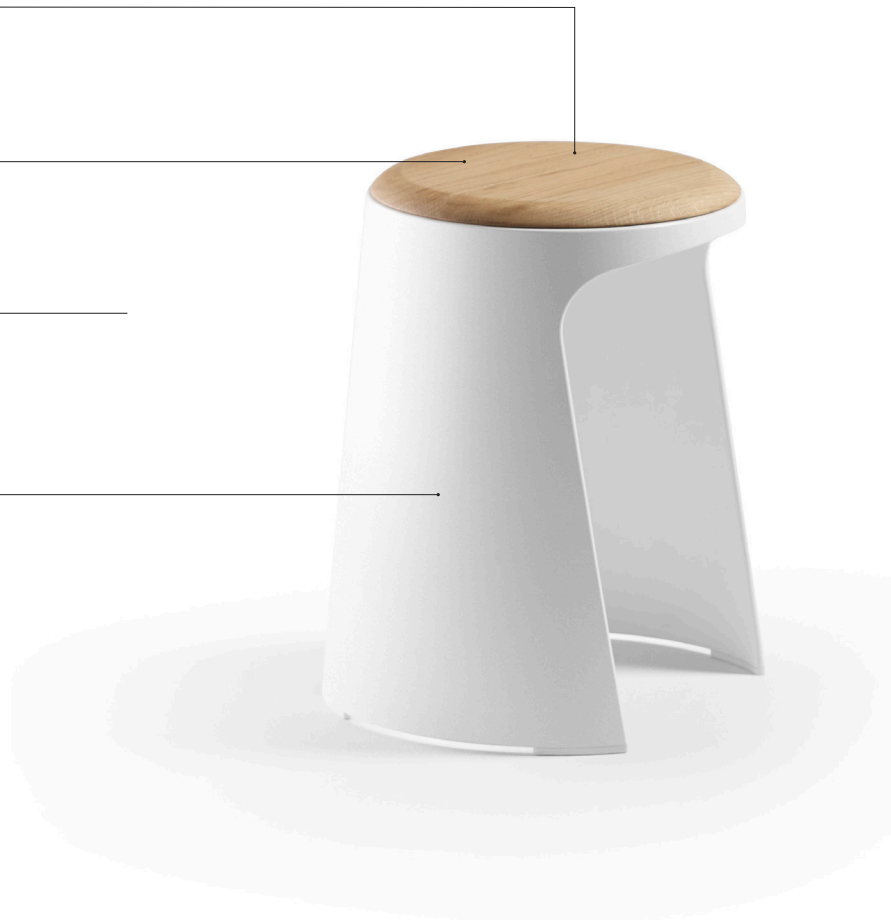

HANDY STOOL

Design: Stephen Philips (ARUP), licensed by Sellex

HA5



Handy Stool	MODEL	LIST PRICE
Polypropylene shell W 16 D 14.5 H 18	HYS-P	\$199



Handy Stool	MODEL	LIST PRICE/GRADE	COM/COL	A	B	C	D	E	F	G	H	I	J	K	L
Polypropylene shell, upholstered seat onlay W 16 D 14.5 H 18.25	HYS-U		\$342	354	365	377	388	400	411	423	434	446	458	469	526
COM Yardage: 1 or 2 seats: .75 yard; 3 or 4 seats: 1.5 yards; 5 or 6 seats: 2.25 yards															
Contact Leland Customer Experience for yardage requirements on textiles with repeats.															
For COL requirements please contact Leland Customer Experience.															



Handy Stool	MODEL	LIST PRICE
Wood onlay W 16 D 14.5 H 18.5	HYS-W	\$347

To specify:
Please refer to pages 3-4 for complete specifying information.
Specify all products by their product code.

Pricing Effective: January 2025

HANDY STOOL DOLLY

Design: Stephen Philips (ARUP), licensed by Sellex

HA6



Handy Stool Dolly	MODEL	LIST PRICE
Single	HYD-S	\$894
W 20.75 D 20.75 H 3.75	*Product stacks 10 high on a single dolly.	

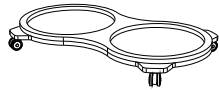

Handy Stool Dolly	MODEL	LIST PRICE
Double	HYD-D	\$1249
W 37 D 20.75 H 3.75	*Product stacks 10 high, 2 stacks on a double dolly.	

To specify:
Please refer to pages 3-4 for complete specifying information.
Specify all products by their product code.

Pricing Effective: January 2025

5695 Eagle Drive, SE
Grand Rapids,
Michigan 49512
616-975-9260
lelandfurniture.com

Leah Table

January 2025 Price List

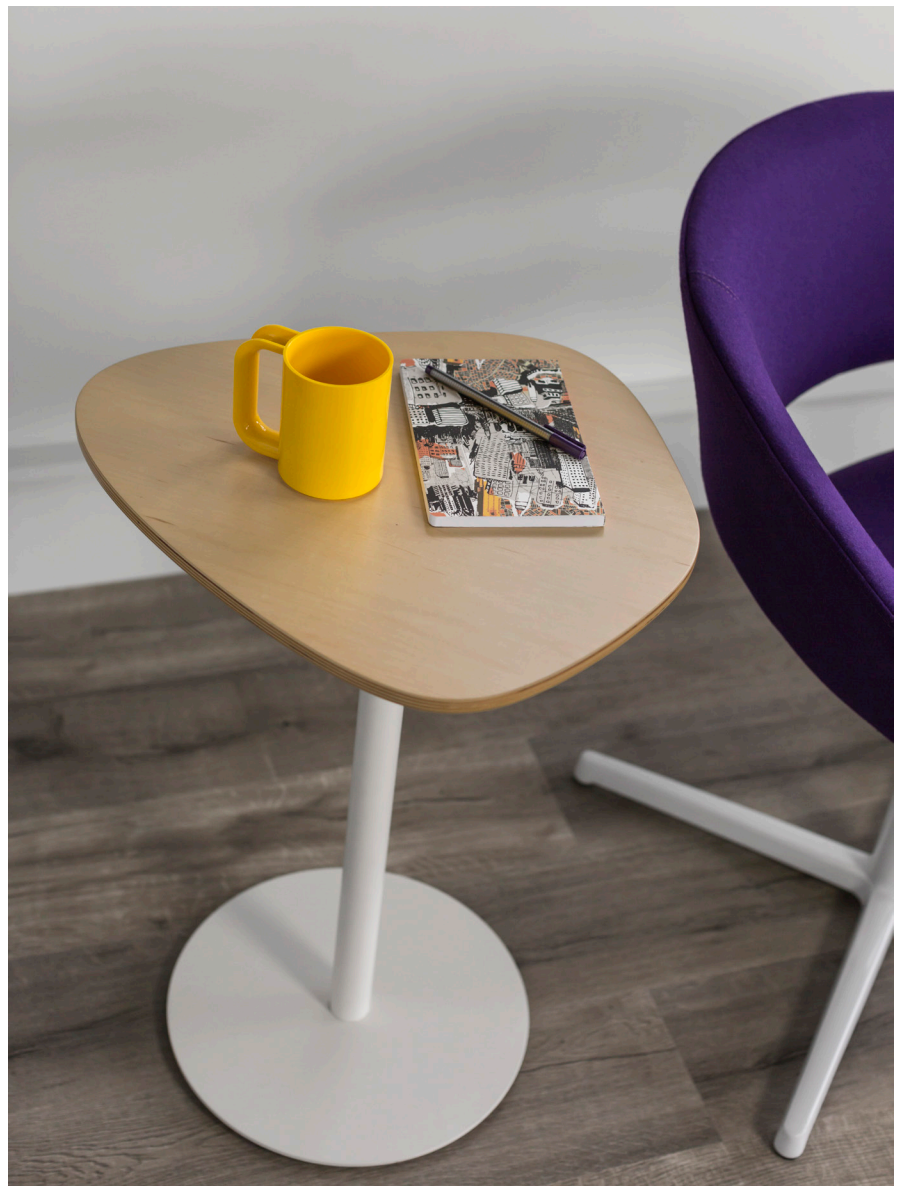

Leah Table

Table of Contents	LT2
Visual Reference	LT3
Specification Information	LT4
Specification Example	LT5
Ripple Table	LT6
Pond Table	LT7
Puddle Table	LT8
Soft Square Table	LT9
Round Table	LT10

TABLE MODEL		TABLE TOP SIZES	BASE	PAGE
Ripple (LTRP)		18x18 22x22 24x24 30x30	Powder Coat	Page LT6

TABLE MODEL		TABLE TOP SIZES	BASE	PAGE
Pond (LTPN)		22.5x15 45x30	Powder Coat	Page LT7



TABLE MODEL		TABLE TOP SIZES	BASE	PAGE
Puddle (LTPL)		22.5x15 45x30	Powder Coat	Page LT8

TABLE MODEL		TABLE TOP SIZES	BASE	PAGE
Soft Square (LTSS)		18x18 24x24 30x30	Powder Coat	Page LT9

Model

DESCRIPTION	CODE
Ripple	LTRP
Pond	LTPN
Puddle	LTPL
Soft Square	LTSS
Round	LTRD

Top Size **RIPPLE: POND/PUDDLE:**

DESCRIPTION	CODE	DESCRIPTION	CODE
18x18	1818	22.5x15	2315
22x22	2222	45x30	4530
24x24	2424		
30x30	3030		

SOFT SQUARE: ROUND:

DESCRIPTION	CODE	DESCRIPTION	CODE
18x18	1818	18D	18D
24x24	2424	24D	24D
30x30	3030	30D	30D

Top Finish**LELAND COLORS**

DESCRIPTION	CODE
Ash	A
Walnut *quarter cut veneer	W
Maple	MP

TEXTURED PAINT

DESCRIPTION	CODE
White	WT
Black	BT
Dolphin	DLT

SOLID SURFACE

DESCRIPTION	CODE
Black Lava Formica®	FR501
Frost Formica®	FR103
Luna Steel Formica®	FR415

BACK PAINTED GLASS

DESCRIPTION	CODE
White	WG
Black	BG

LAMINATE

DESCRIPTION	CODE
Kensington Maple Wilsonart®(10776-60)	LMP
Florence Walnut Wilsonart® (7993-38)	LWN
Black Pionite® (SE101)	LBK
White Wilsonart® (D354-60)	LWH

Base Height

DESCRIPTION	CODE
14"	14H
18"	18H
22"	22H
28" (Available with 18x18 Ripple, 18x18 Soft Square, and 18D and 24D Round Tops only)	28H

Base Finish

DESCRIPTION	CODE	DESCRIPTION	CODE
White Textured	WT	Oxford Textured	OXT
Black Textured	BT	Sterling	ST
Dolphin Textured	DLT	Matte Blue Sky	MBS
Matte Frost	MFO	Matte Sienna	MSN
Matte Willow	MWL		

Glide Type

DESCRIPTION
Black HDPE Glide Plate

Edge Type

DESCRIPTION	DESCRIPTION
6mm Glass Top 	1/2" Wood Top 
1/2" Laminated Top 	1/2" Solid Surface Top 

Edge Options**LAMINATE EDGE FINISH**

DESCRIPTION	CODE
Natural	11M

Specifications required to create the product code

- Model
- Top Size
- Top Finish
- Edge Type
- Edge Finish
- Base Height
- Base Finish

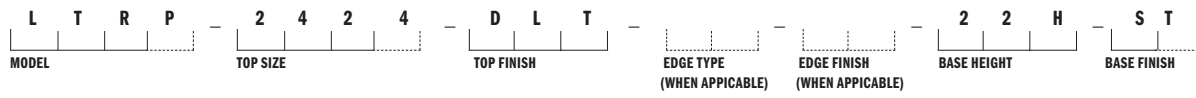

MODEL

Ripple (LTRP)

TOP SIZE

24x24 (2424)

TOP FINISH

Dolphin Textured

EDGE TYPE

Not applicable

EDGE FINISH

Not applicable

BASE HEIGHT

22" Base (22H)

BASE FINISH

Sterling Powder coat (ST)

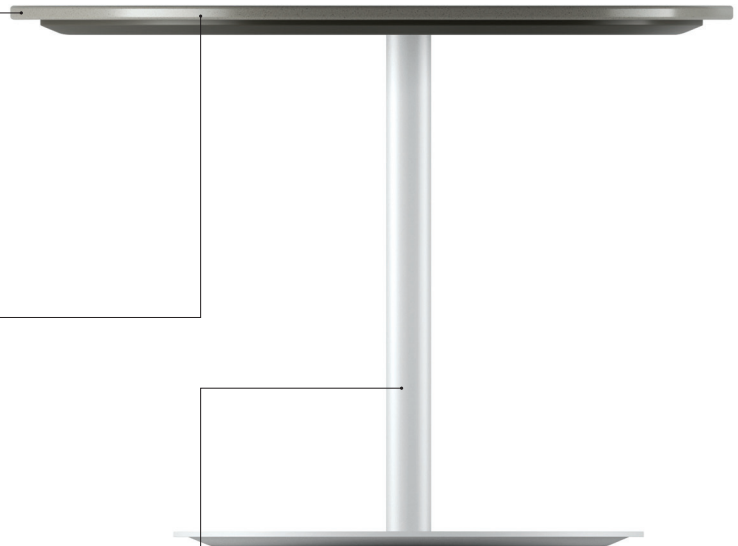

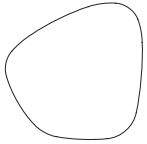

**18" Ripple,
Powder Coat Base**

	MODEL	TOP FINISH	TEXTURED PAINT	MAPLE	ASH	WALNUT	LAMINATE	BLACK PAINTED GLASS	SOLID SURFACE
18x18" Top	LTRP-1818	14" Base	\$1138	1252	1252	1313	1381	1601	1577
		18" Base	\$1149	1262	1262	1324	1395	1612	1589
		22" Base	\$1161	1272	1272	1334	1406	1620	1599
		28" Base	\$1185	1296	1296	1355	1428	1633	1611

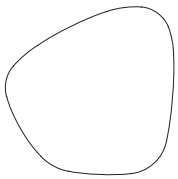

**22" Ripple,
Powder Coat Base**

	MODEL	TOP FINISH	TEXTURED PAINT	MAPLE	ASH	WALNUT	LAMINATE	BLACK PAINTED GLASS	SOLID SURFACE
22x22" Top	LTRP-2222	14" Base	\$1249	1371	1371	1447	1516	1999	1962
		18" Base	\$1260	1380	1380	1458	1526	2009	1976
		22" Base	\$1268	1394	1394	1468	1540	2018	1984

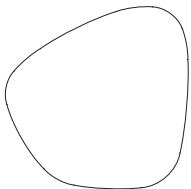

**24" Ripple,
Powder Coat Base**

	MODEL	TOP FINISH	TEXTURED PAINT	MAPLE	ASH	WALNUT	LAMINATE	BLACK PAINTED GLASS	SOLID SURFACE
24x24" Top	LTRP-2424	14" Base	\$1353	1485	1485	1566	1586	2151	2104
		18" Base	\$1360	1496	1496	1575	1595	2160	2115
		22" Base	\$1370	1506	1506	1587	1607	2171	2127

To specify:
Please refer to pages 4-5 for complete specifying information.
Specify all products by their product code.

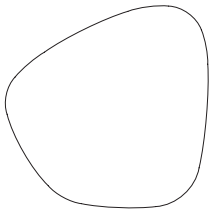

**30" Ripple,
Powder Coat Base**

	MODEL	TOP FINISH	TEXTURED PAINT	MAPLE	ASH	WALNUT	LAMINATE	BLACK PAINTED GLASS	SOLID SURFACE
30x30" Top	LTRP-3030	14" Base	\$1520	1668	1668	1767	1841	2810	2728
		18" Base	\$1527	1680	1680	1781	1848	2821	2739
		22" Base	\$1540	1691	1691	1789	1858	2828	2750

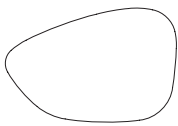

**22.5" Pond,
Powder Coat Base**

	MODEL	TOP FINISH	TEXTURED PAINT	MAPLE	ASH	WALNUT	LAMINATE	BLACK PAINTED GLASS	SOLID SURFACE
22.5x15" Top	LTPN-2315	14" Base	\$1263	1388	1388	1464	1613	2061	2046
		18" Base	\$1272	1397	1397	1474	1620	2066	2054
		22" Base	\$1280	1408	1408	1485	1634	2081	2067

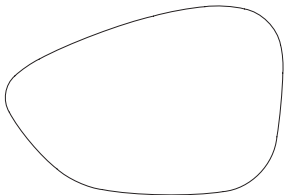

**45" Pond,
Powder Coat Base**

	MODEL	TOP FINISH	TEXTURED PAINT	MAPLE	ASH	WALNUT	LAMINATE	BLACK PAINTED GLASS	SOLID SURFACE
45x30" Top	LTPN-4530	14" Base	\$1983	2177	2177	2306	2400	3881	3750
		18" Base	\$1992	2187	2187	2318	2412	3890	3762
		22" Base	\$1999	2199	2199	2327	2423	3901	3772

To specify:
Please refer to pages 4-5 for complete specifying information.
Specify all products by their product code.

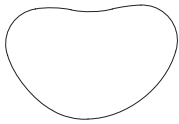

**22.5" Puddle,
Powder Coat Base**

	MODEL	TOP FINISH	TEXTURED PAINT	MAPLE	ASH	WALNUT	LAMINATE	BLACK PAINTED GLASS	SOLID SURFACE
22.5x15" Top	LTPL-2315	14" Base	\$1263	1388	1388	1464	1613	2061	2046
		18" Base	\$1272	1397	1397	1474	1620	2066	2054
		22" Base	\$1280	1408	1408	1485	1634	2081	2067

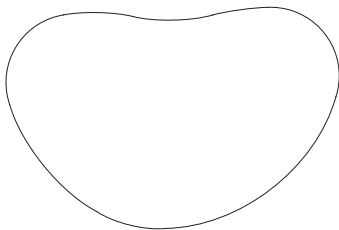

**45" Puddle,
Powder Coat Base**

	MODEL	TOP FINISH	TEXTURED PAINT	MAPLE	ASH	WALNUT	LAMINATE	BLACK PAINTED GLASS	SOLID SURFACE
45x30" Top	LTPL-4530	14" Base	\$1983	2177	2177	2306	2400	3881	3750
		18" Base	\$1992	2187	2187	2318	2412	3890	3762
		22" Base	\$1999	2199	2199	2327	2423	3901	3772

To specify:
Please refer to pages 4-5 for complete specifying information.
Specify all products by their product code.

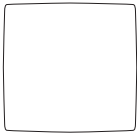

**18" Soft Square,
Powder Coat Base**

	MODEL	TOP FINISH	TEXTURED PAINT	MAPLE	ASH	WALNUT	LAMINATE	BLACK PAINTED GLASS	SOLID SURFACE
18x18" Top	LTSS-1818	14" Base	\$1257	1376	1376	1444	1512	1755	1736
		18" Base	\$1263	1389	1389	1456	1525	1766	1748
		22" Base	\$1274	1401	1401	1468	1540	1780	1759
		28" Base	\$1286	1413	1413	1483	1554	1798	1774

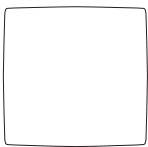

**24" Soft Square,
Powder Coat Base**

	MODEL	TOP FINISH	TEXTURED PAINT	MAPLE	ASH	WALNUT	LAMINATE	BLACK PAINTED GLASS	SOLID SURFACE
24x24" Top	LTSS-2424	14" Base	\$1488	1634	1634	1721	1742	2358	2316
		18" Base	\$1499	1644	1644	1735	1751	2368	2325
		22" Base	\$1507	1655	1655	1746	1763	2379	2336

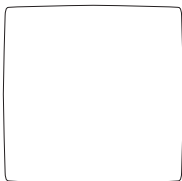

**30" Soft Square,
Powder Coat Base**

	MODEL	TOP FINISH	TEXTURED PAINT	MAPLE	ASH	WALNUT	LAMINATE	BLACK PAINTED GLASS	SOLID SURFACE
30x30" Top	LTSS-3030	14" Base	\$1671	1835	1835	1944	2015	3078	3002
		18" Base	\$1682	1847	1847	1955	2027	3089	3013
		22" Base	\$1692	1858	1858	1965	2036	3100	3024

To specify:
Please refer to pages 4-5 for complete specifying information.
Specify all products by their product code.

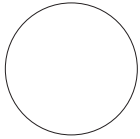

**18" Round,
Powder Coat Base**

	MODEL	TOP FINISH	TEXTURED PAINT	MAPLE	ASH	WALNUT	LAMINATE	BLACK PAINTED GLASS	SOLID SURFACE
18x18" Round Top	LTRD-18D	14" Base	\$1257	1376	1376	1444	1512	1755	1736
		18" Base	\$1263	1389	1389	1456	1525	1766	1748
		22" Base	\$1274	1401	1401	1468	1540	1780	1759
		28" Base	\$1295	1426	1426	1495	1563	1805	1786

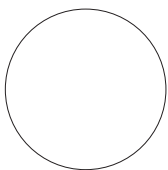

**24" Round,
Powder Coat Base**

	MODEL	TOP FINISH	TEXTURED PAINT	MAPLE	ASH	WALNUT	LAMINATE	BLACK PAINTED GLASS	SOLID SURFACE
24x24" Round Top	LTRD-24D	14" Base	\$1488	1634	1634	1721	1742	2358	2316
		18" Base	\$1499	1644	1644	1735	1751	2368	2325
		22" Base	\$1507	1655	1655	1746	1763	2379	2336

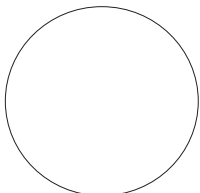

**30" Round,
Powder Coat Base**

	MODEL	TOP FINISH	TEXTURED PAINT	MAPLE	ASH	WALNUT	LAMINATE	BLACK PAINTED GLASS	SOLID SURFACE
30x30" Round Top	LTRD-30D	14" Base	\$1671	1835	1835	1944	2015	3078	3002
		18" Base	\$1682	1847	1847	1955	2027	3089	3013
		22" Base	\$1692	1858	1858	1965	2036	3100	3024

To specify:
Please refer to pages 4-5 for complete specifying information.
Specify all products by their product code.

5695 Eagle Drive, SE
Grand Rapids,
Michigan 49512
616-975-9260
lelandfurniture.com

M2 Seating

January 2025 Price List

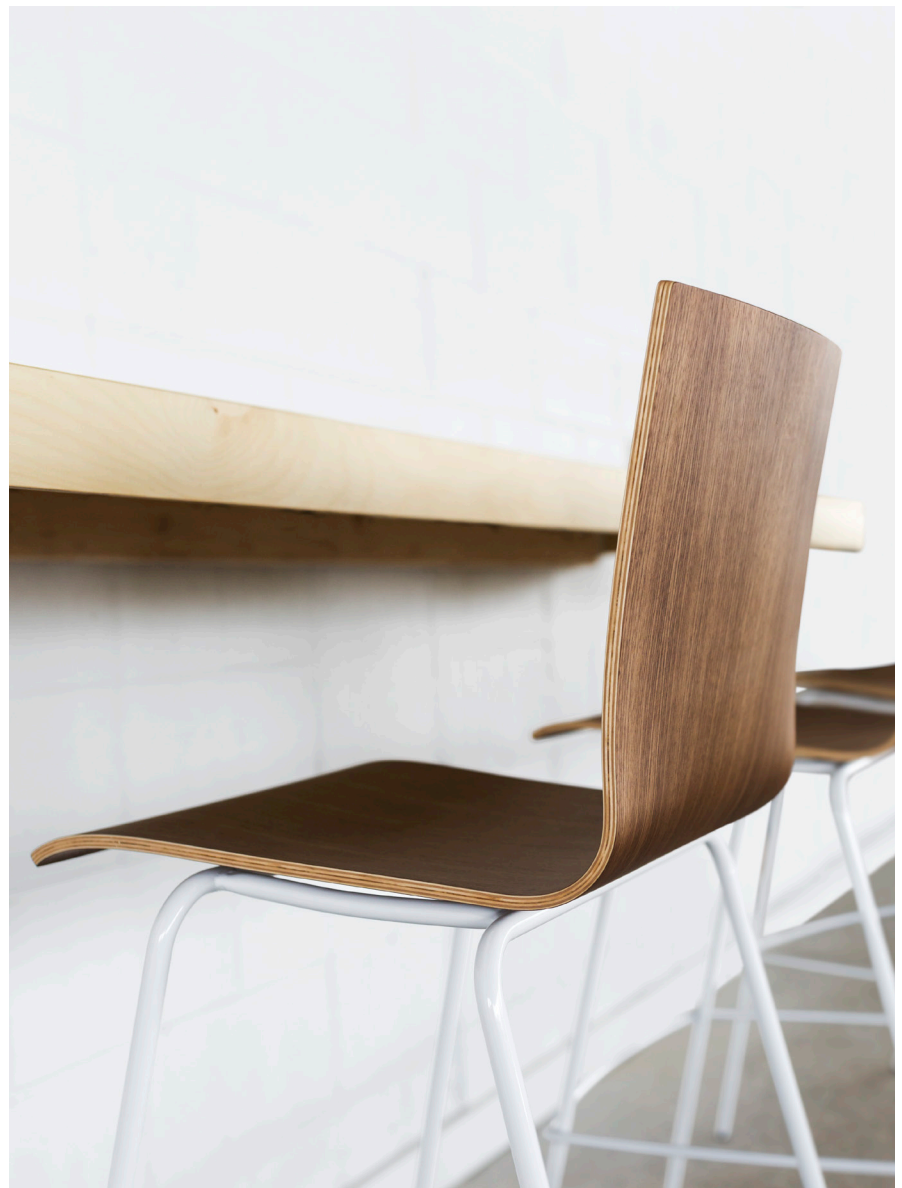

M2 Seating

Table of Contents	M2S2
Specification Information	M2S3
Specification Example	M2S4
Side Chair	M2S5
Stacking Side Chair	M2S6
Counter Chair	M2S7
Stacking Counter Chair	M2S8
Bar Chair	M2S9
Stacking Bar Chair	M2S10
Transport/Stacking Dolly	M2S11





Chair Model

DESCRIPTION	CODE
M2 side chair	M2S
M2 side chair, upholstered seat	M2SU
M2 stacking side chair	M2SS
M2 stacking side chair, upholstered seat	M2SSU
M2 counter chair	M2C
M2 counter chair, upholstered seat	M2CU
M2 stacking counter chair	M2CS
M2 stacking counter chair, upholstered seat	M2CSU
M2 bar chair	M2B
M2 bar chair, upholstered seat	M2BU
M2 stacking bar chair	M2BS
M2 stacking bar chair, upholstered seat	M2BSU

Shell Veneer

DESCRIPTION	CODE
Standard	S
Walnut	W

Shell Cut Out

DESCRIPTION	CODE	DESCRIPTION	CODE
 Plain	1	 Square	7
 Circle	2	 Soft Square	9
Rectangle	8		

Shell Finish

STANDARD SHELL:

STANDARD LELAND COLORS

CUSTOM SPECIFY Custom (01)

*Please note that M2 Standard Shell is NOT AVAILABLE in the following finishes:
 Natural Walnut Matte (08M), Natural Beech (09), Natural White Oak Matte (12M)

WALNUT SHELL:

DESCRIPTION	CODE
Natural Walnut	08M

TWO-TONE SHELL:

DESCRIPTION	CODE
Black/Natural	BKC
White/Natural	WHC

Please note that the product is only available in the Natural Finishes listed above.

Frame Finish: Powder Coat and Chrome

DESCRIPTION	CODE
Sterling	ST
Warm Grey	WG
Cool Grey	B
Black	CG
White	W
Chrome	C
Matte Mercury	MMR
Matte Mineral	MMN
Matte Burnish	MBN
Matte Foundry	MFN
Matte Blue Sky	MBS
Matte Forest	MFO
Matte Sienna	MSN
Matte Willow	MWL

TEXTURED	CODE
Dolphin Textured	DLT
Oxford Textured	OXT
Black Textured	BT
White Textured	WT

Upholstered Onlay Selection

Please refer to Leland Textile Program which features textiles and leathers from the following partners:

- Camira
- Green Hides
- Carnegie
- Maharam
- CF Stinson
- Unika Vaev

The complete grade list can be found on our website or you can specify COM/COL. Due to the design of this product, it is recommended that all non pre-approved textile be tested for compatibility.

Glide Type

STANDARD:

DESCRIPTION	CODE
Nylon	S

OPTIONAL:

Please note that optional glides raise the chair height .5 inch.

DESCRIPTION	CODE
Felt	FC
Floor Saver™ (for VCT type floors)	FS
Metal	M
Rubber	R

Specifications required to create the product code

- Model
- Shell Veneer
- Cut Out
- Shell Finish
- Frame Finish
- Upholstery Selection (when applicable)
- Glide Type

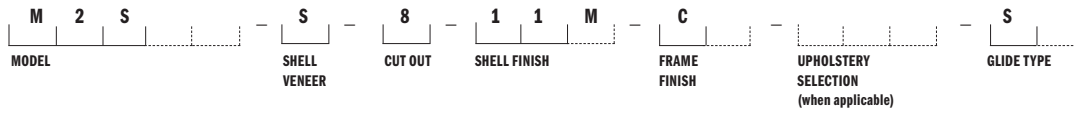

MODEL

M2 Side Chair (M2S)

SHELL VENEER

Standard (S)

CUT OUT

Rectangle (8)

SHELL FINISH

Natural (11M)

FRAME FINISH

Chrome (C)

UPHOLSTERY SELECTION

When applicable, enter upholstery grade, COM or COL



M2 SIDE CHAIR
Design: Leland Design Group

M2S5



M2 Side Chair				MODEL	FRAME FINISH	LIST PRICE
Standard shell				M2S-S	Powder Coat	\$618
W 22	D 21.5	H 32.25	SH 17.5		Chrome	\$668

Optional Glides: Add \$8.00 net per chair for a set of four (4). Optional Glides raise chair height .5 inch.



M2 Side Chair				MODEL	LIST PRICE/GRADE	COM/COL	A	B	C	D	E	F	G	H	I	J	K	L
Standard shell,				M2SU-S	Powder Coat	\$702	750	773	796	819	842	865	888	911	934	957	980	1003
Upholstered seat					Chrome	\$753	800	824	848	872	896	920	944	968	992	1016	1040	1064

Optional Glides: Add \$8.00 net per chair for a set of four (4). Optional Glides raise chair height .5 inch.

W 22 D 21.5 H 32.25 SH 18.5 COM Yardage: 1 to 4 seats: 1.5 yards

Contact Leland Customer Experience for yardage requirements on textiles with repeats.

For COL requirements please contact Leland Customer Experience.



M2 Side Chair				MODEL	FRAME FINISH	LIST PRICE
Walnut shell				M2S-W	Powder Coat	\$702
W 22	D 21.5	H 32.25	SH 18.5		Chrome	\$753

Optional Glides: Add \$8.00 net per chair for a set of four (4). Optional Glides raise chair height .5 inch.



M2 Side Chair				MODEL	LIST PRICE/GRADE	COM/COL	A	B	C	D	E	F	G	H	I	J	K	L
Walnut shell,				M2SU-W	Powder Coat	\$787	835	859	883	907	931	955	979	1003	1027	1051	1075	1099
Upholstered seat					Chrome	\$838	886	910	934	958	982	1006	1030	1054	1078	1102	1126	1150

Optional Glides: Add \$8.00 net per chair for a set of four (4). Optional Glides raise chair height .5 inch.

W 22 D 21.5 H 32.25 SH 18.5 COM Yardage: 1 to 4 seats: 1.5 yards

Contact Leland Customer Experience for yardage requirements on textiles with repeats.

For COL requirements please contact Leland Customer Experience.

To specify:

Please refer to pages 3-5 for complete specifying information.

Specify all products by their product code.

M2 STACKING SIDE CHAIR
Design: Leland Design Group

M2S6



M2 Stacking Side Chair				MODEL	FRAME FINISH	LIST PRICE
Standard shell				M2SS-S	Powder Coat	\$650
W 22	D 21.5	H 32.25	SH 17.5		Chrome	\$702

Optional Glides: Add \$8.00 net per chair for a set of four (4). Optional Glides raise chair height .5 inch.



M2 Stacking Side Chair				MODEL	LIST PRICE/GRADE	COM/COL	A	B	C	D	E	F	G	H	I	J	K	L
Standard shell,				M2SSU-S	Powder Coat	\$736	784	807	830	853	876	899	922	945	968	991	1014	1037
Upholstered seat					Chrome	\$787	835	859	883	907	931	955	979	1003	1027	1051	1075	1099

Optional Glides: Add \$8.00 net per chair for a set of four (4). Optional Glides raise chair height .5 inch.

COM Yardage: 1 to 4 seats: 1.5 yards

Contact Leland Customer Experience for yardage requirements on textiles with repeats.

For COL requirements please contact Leland Customer Experience.



M2 Stacking Side Chair				MODEL	FRAME FINISH	LIST PRICE
Walnut shell				M2SS-W	Powder Coat	\$736
W 22	D 21.5	H 32.25	SH 18.5		Chrome	\$847

Optional Glides: Add \$8.00 net per chair for a set of four (4). Optional Glides raise chair height .5 inch.



M2 Stacking Side Chair				MODEL	LIST PRICE/GRADE	COM/COL	A	B	C	D	E	F	G	H	I	J	K	L
Walnut shell,				M2SSU-W	Powder Coat	\$821	868	892	916	940	964	988	1012	1036	1060	1084	1108	1132
Upholstered seat					Chrome	\$872	920	945	970	995	1020	1045	1070	1095	1120	1145	1170	1195

Optional Glides: Add \$8.00 net per chair for a set of four (4). Optional Glides raise chair height .5 inch.

COM Yardage: 1 to 4 seats: 1.5 yards

Contact Leland Customer Experience for yardage requirements on textiles with repeats.

For COL requirements please contact Leland Customer Experience.

To specify:
Please refer to pages 3-5 for complete specifying information.
Specify all products by their product code.

Pricing Effective: January 2025

M2 COUNTER CHAIR
Design: Leland Design Group

M2S7

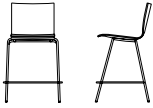

M2 Counter Chair				MODEL	FRAME FINISH	LIST PRICE
Standard shell				M2C-S	Powder Coat	\$916
W 22	D 21.5	H 32.25	SH 17.5		Chrome	\$970

Optional Glides: Add \$8.00 net per chair for a set of four (4). Optional Glides raise chair height .5 inch.



M2 Counter Chair				MODEL	LIST PRICE/GRADE	COM/COL	A	B	C	D	E	F	G	H	I	J	K	L
Standard shell,				M2CU-S	Powder Coat	\$1004	1050	1076	1102	1128	1154	1180	1206	1232	1258	1284	1310	1336
Upholstered seat					Chrome	\$1056	1105	1129	1153	1177	1201	1225	1249	1273	1297	1321	1345	1369

Optional Glides: Add \$8.00 net per chair for a set of four (4). Optional Glides raise chair height .5 inch.

W 22 D 21.5 H 32.25 SH 18.5

COM Yardage: 1 to 4 seats: 1.5 yards

Contact Leland Customer Experience for yardage requirements on textiles with repeats.

For COL requirements please contact Leland Customer Experience.



M2 Counter Chair				MODEL	FRAME FINISH	LIST PRICE
Walnut shell				M2C-W	Powder Coat	\$1004
W 22	D 21.5	H 32.25	SH 18.5		Chrome	\$1056

Optional Glides: Add \$8.00 net per chair for a set of four (4). Optional Glides raise chair height .5 inch.



M2 Counter Chair				MODEL	LIST PRICE/GRADE	COM/COL	A	B	C	D	E	F	G	H	I	J	K	L
Walnut shell,				M2CU-W	Powder Coat	\$1093	1141	1164	1187	1210	1233	1256	1279	1302	1325	1348	1371	1394
Upholstered seat					Chrome	\$1145	1193	1217	1241	1265	1289	1313	1337	1361	1385	1409	1433	1457

Optional Glides: Add \$8.00 net per chair for a set of four (4). Optional Glides raise chair height .5 inch.

W 22 D 21.5 H 32.25 SH 18.5

COM Yardage: 1 to 4 seats: 1.5 yards

Contact Leland Customer Experience for yardage requirements on textiles with repeats.

For COL requirements please contact Leland Customer Experience.

To specify:
Please refer to pages 3-5 for complete specifying information.
Specify all products by their product code.

M2 STACKING COUNTER CHAIR
Design: Leland Design Group

M2S8

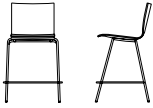

M2 Stacking Counter Chair				MODEL	FRAME FINISH	LIST PRICE
Standard shell				M2CS-S	Powder Coat	\$952
W 22	D 21.5	H 32.25	SH 17.5		Chrome	\$1005

Optional Glides: Add \$8.00 net per chair for a set of four (4). Optional Glides raise chair height .5 inch.



M2 Stacking Counter Chair				MODEL	LIST PRICE/GRADE	COM/COL	A	B	C	D	E	F	G	H	I	J	K	L
Standard shell,				M2CSU-S	Powder Coat	\$1043	1090	1114	1138	1162	1186	1210	1234	1258	1282	1306	1330	1354
Upholstered seat					Chrome	\$1093	1141	1164	1187	1210	1233	1256	1279	1302	1325	1348	1371	1394

Optional Glides: Add \$8.00 net per chair for a set of four (4). Optional Glides raise chair height .5 inch.

COM Yardage: 1 to 4 seats: 1.5 yards

Contact Leland Customer Experience for yardage requirements on textiles with repeats.

For COL requirements please contact Leland Customer Experience.

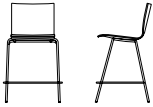

M2 Stacking Counter Chair				MODEL	FRAME FINISH	LIST PRICE
Walnut shell				M2CS-W	Powder Coat	\$1043
W 22	D 21.5	H 32.25	SH 18.5		Chrome	\$1093

Optional Glides: Add \$8.00 net per chair for a set of four (4). Optional Glides raise chair height .5 inch.



M2 Stacking Counter Chair				MODEL	LIST PRICE/GRADE	COM/COL	A	B	C	D	E	F	G	H	I	J	K	L
Walnut shell,				M2CSU-W	Powder Coat	\$1131	1179	1204	1229	1254	1279	1304	1329	1354	1379	1404	1429	1454
Upholstered seat					Chrome	\$1183	1230	1255	1280	1305	1330	1355	1380	1405	1430	1455	1480	1505

Optional Glides: Add \$8.00 net per chair for a set of four (4). Optional Glides raise chair height .5 inch.

COM Yardage: 1 to 4 seats: 1.5 yards

Contact Leland Customer Experience for yardage requirements on textiles with repeats.

For COL requirements please contact Leland Customer Experience.

To specify:
Please refer to pages 3-5 for complete specifying information.
Specify all products by their product code.

M2 BAR CHAIR
Design: Martin Ballendat

M2S9



M2 Bar Chair				MODEL	FRAME FINISH	LIST PRICE
Standard shell				M2B-S	Powder Coat	\$933
W 22	D 21.5	H 32.25	SH 17.5		Chrome	\$986

Optional Glides: Add \$8.00 net per chair for a set of four (4). Optional Glides raise chair height .5 inch.



M2 Bar Chair				MODEL	LIST PRICE/GRADE	COM/COL	A	B	C	D	E	F	G	H	I	J	K	L
Standard shell,				M2BU-S	Powder Coat	\$1021	1069	1093	1117	1141	1165	1189	1213	1237	1261	1285	1309	1333
Upholstered seat					Chrome	\$1076	1124	1148	1172	1196	1220	1244	1268	1292	1316	1340	1364	1388

Optional Glides: Add \$8.00 net per chair for a set of four (4). Optional Glides raise chair height .5 inch.

COM Yardage: 1 to 4 seats: 1.5 yards

Contact Leland Customer Experience for yardage requirements on textiles with repeats.

For COL requirements please contact Leland Customer Experience.



M2 Bar Chair				MODEL	FRAME FINISH	LIST PRICE
Walnut shell				M2B-W	Powder Coat	\$1021
W 22	D 21.5	H 32.25	SH 18.5		Chrome	\$1076

Optional Glides: Add \$8.00 net per chair for a set of four (4). Optional Glides raise chair height .5 inch.



M2 Bar Chair				MODEL	LIST PRICE/GRADE	COM/COL	A	B	C	D	E	F	G	H	I	J	K	L
Walnut shell,				M2BU-W	Powder Coat	\$1112	1159	1183	1207	1231	1255	1279	1303	1327	1351	1375	1399	1423
Upholstered seat					Chrome	\$1165	1214	1239	1264	1289	1314	1339	1364	1389	1414	1439	1464	1489

Optional Glides: Add \$8.00 net per chair for a set of four (4). Optional Glides raise chair height .5 inch.

COM Yardage: 1 to 4 seats: 1.5 yards

Contact Leland Customer Experience for yardage requirements on textiles with repeats.

For COL requirements please contact Leland Customer Experience.

To specify:
Please refer to pages 3-5 for complete specifying information.
Specify all products by their product code.

M2 STACKING BAR CHAIR
Design: Martin Ballendat

M2S10



M2 Stacking Bar Chair				MODEL	FRAME FINISH	LIST PRICE
Standard shell				M2BS-S	Powder Coat	\$971
W 22	D 21.5	H 32.25	SH 17.5		Chrome	\$1022

Optional Glides: Add \$8.00 net per chair for a set of four (4). Optional Glides raise chair height .5 inch.



M2 Stacking Bar Chair				MODEL	LIST PRICE/GRADE	COM/COL	A	B	C	D	E	F	G	H	I	J	K	L
Standard shell,				M2BSU-S	Powder Coat	\$1060	1108	1132	1156	1180	1204	1228	1252	1276	1300	1324	1348	1372
Upholstered seat					Chrome	\$1113	1160	1186	1212	1238	1264	1290	1316	1342	1368	1394	1420	1446

Optional Glides: Add \$8.00 net per chair for a set of four (4). Optional Glides raise chair height .5 inch.

W 22 D 21.5 H 32.25 SH 18.5

COM Yardage: 1 to 4 seats: 1.5 yards

Contact Leland Customer Experience for yardage requirements on textiles with repeats.

For COL requirements please contact Leland Customer Experience.



M2 Stacking Bar Chair				MODEL	FRAME FINISH	LIST PRICE
Walnut shell				M2BS-W	Powder Coat	\$1060
W 22	D 21.5	H 32.25	SH 18.5		Chrome	\$1113

Optional Glides: Add \$8.00 net per chair for a set of four (4). Optional Glides raise chair height .5 inch.



M2 Stacking Bar Chair				MODEL	LIST PRICE/GRADE	COM/COL	A	B	C	D	E	F	G	H	I	J	K	L
Walnut shell,				M2BSU-W	Powder Coat	\$1149	1196	1221	1246	1271	1296	1321	1346	1371	1396	1421	1446	1471
Upholstered seat					Chrome	\$1202	1250	1275	1300	1325	1350	1375	1400	1425	1450	1475	1500	1525

Optional Glides: Add \$8.00 net per chair for a set of four (4). Optional Glides raise chair height .5 inch.

W 22 D 21.5 H 32.25 SH 18.5

COM Yardage: 1 to 4 seats: 1.5 yards

Contact Leland Customer Experience for yardage requirements on textiles with repeats.

For COL requirements please contact Leland Customer Experience.

To specify:

Please refer to pages 3-5 for complete specifying information.

Specify all products by their product code.



**M2 Chair Transport/
Stacking Dolly**

	MODEL	FRAME FINISH	LIST PRICE
Standard shell	M2D	Powder Coat	\$1380
W 23 D 33 H 6 (empty)			

To specify:
Please refer to pages 3-5 for
complete specifying information.
Specify all products by their
product code.

5695 Eagle Drive, SE
Grand Rapids,
Michigan 49512
616-975-9260
lelandfurniture.com

M3 Table

January 2025 Price List



M3 Table

Table of Contents	M3T2
Soft Square Pedestal Table Base Visual Reference	M3T4
Soft Square Counter & Bar Base Visual Reference	M3T5
Circle Pedestal Table Base Visual Reference	M3T6
Circle Counter & Bar Table Base Visual Reference	M3T7
Specification Information	M38
Specification Example	M3T10
Small Soft Square Base	M3T11
Medium Soft Square Base	M3T12
Large Soft Square Base	M3T13
Extra Large Soft Square Base	M3T14
Small Soft Square Counter Base	M3T15
Large Soft Square Counter Base	M3T16
Small Soft Square Bar Base	M3T17
Large Soft Square Bar Base	M3T18
Extra Small Circle Base	M3T19
Small Circle Base	M3T20
Medium Circle Base	M3T21
Large Circle Base	M3T22
Extra Large Circle Base	M3T23
Extra-Extra Large Circle Base	M3T24
Extra Small Circle Counter Base	M3T25
Small Circle Counter Base	M3T26
Medium Circle Counter Base	M3T27

M3 Table

Extra Small Circle Bar Base	M3T28
Small Circle Bar Base	M3T29
Large Circle Bar Base	M3T30













TABLE MODEL	TABLE TOP SIZES			BASE	COLUMN/BASE	PAGE
Small Soft Square Pedestal Table Base	 24 DIA 30 DIA	 24 x 24 30 x 30	 24 x 30	18" Soft Square	Powder Coat/Powder Coat	Page M3T11
						
Medium Soft Square Pedestal Table Base	 36 DIA	 36 x 36		20" Soft Square	Powder Coat/Powder Coat	Page M3T12
						
Large Soft Square Pedestal Table Base	 42 DIA	 42 x 42		22" Soft Square	Powder Coat/Powder Coat	Page M3T13
						
Extra Large Soft Square Pedestal Table Base	 48 DIA	 48 x 48		24" Soft Square	Powder Coat/Powder Coat	Page M3T14
						





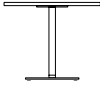

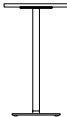



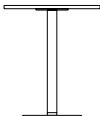

TABLE MODEL	TABLE TOP SIZES			BASE	COLUMN/BASE	PAGE
Small Soft Square Counter Table Base	Round	Square	Rectangle	18" Soft Square	Powder Coat/Powder Coat	Page M3T15
						
	24 DIA	24 x 24	24 x 30			
	30 DIA	30 x 30				
Large Soft Square Counter Table Base	Round	Square		24" Soft Square	Powder Coat/Powder Coat	Page M3T16
						
	36 DIA	36 x 36				
Small Soft Square Bar Table Base	Round	Square	Rectangle	18" Soft Square	Powder Coat/Powder Coat	Page M3T17
						
	24 DIA	24 x 24	24 x 30			
	30 DIA	30 x 30				
Large Soft Square Bar Table Base	Round	Square		24" Soft Square	Powder Coat/Powder Coat	Page M3T18
						
	36 DIA	36 x 36				







TABLE MODEL	TABLE TOP SIZES		BASE	COLUMN/BASE	PAGE
Extra Small Circle Pedestal Table Base 	Round 24 DIA	Square 24 x 24	18"-Diameter	Powder Coat/Powder Coat	Page M3T19
Small Circle Pedestal Table Base 	Round 30 DIA	Rectangle 24 x 30	20"-Diameter	Powder Coat/Powder Coat	Page M3T20
Medium Circle Pedestal Table Base 	Round 36 DIA	Square 30 x 30	22"-Diameter	Powder Coat/Powder Coat	Page M3T21
Large Circle Pedestal Table Base 	Round 42 DIA	Square 36 x 36	26"-Diameter	Powder Coat/Powder Coat	Page M3T22
Extra Large Circle Pedestal Table Base 	Round 48 DIA	Square 42 x 42	28"-Diameter	Powder Coat/Powder Coat	Page M3T23
Extra-Extra Large Circle Pedestal Table Base 		Square 48 x 48	30"-Diameter	Powder Coat/Powder Coat	Page M3T24



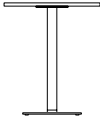



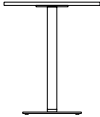

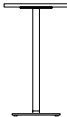

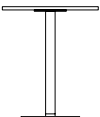



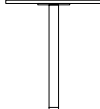

TABLE MODEL	TABLE TOP SIZES			BASE	COLUMN/BASE	PAGE
Extra Small Circle Counter Table Base 	Round  24 DIA			18"-Diameter	Powder Coat/Powder Coat	Page M3T25
Small Circle Counter Table Base 	Round  30 DIA	Square  24 x 24	Rectangle  24 x 30	20"-Diameter	Powder Coat/Powder Coat	Page M3T26
Medium Circle Counter Table Base 	Round  36 DIA	Square  30 x 30		22"-Diameter	Powder Coat/Powder Coat	Page M3T27
Extra Small Circle Bar Table Base 	Round  24 DIA			18"-Diameter	Powder Coat/Powder Coat	Page M3T28
Small Circle Bar Table Base 	Round  30 DIA	Square  24 x 24	Rectangle  24 x 30	20"-Diameter	Powder Coat/Powder Coat	Page M3T29
Medium Circle Bar Table Base 	Round  36 DIA	Square  30 x 30		22"-Diameter	Powder Coat/Powder Coat	Page M3T30

Table Model

DESCRIPTION	CODE
M3 pedestal table, small soft square base	M3SB
M3 pedestal table, medium soft square base	M3MB
M3 pedestal table, large soft square base	M3LB
M3 pedestal table, extra large soft square base	M3XLB
M3 pedestal table, small counter soft square base	M3SCB
M3 pedestal table, large counter soft square base	M3LCB
M3 pedestal table, small bar soft square base	M3SBB
M3 pedestal table, large bar soft square base	M3LBB
M3 pedestal table, extra large circle base	M3CXSB
M3 pedestal table, small circle base	M3CSB
M3 pedestal table, medium circle base	M3CMB
M3 pedestal table, large circle base	M3CLB
M3 pedestal table, extra large circle base	M3CXLB
M3 pedestal table, extra-extra large circle base	M3CXLB
M3 pedestal table, extra small counter circle base	M3CXSCB
M3 pedestal table, small bar circle base	M3CSCB
M3 pedestal table, medium bar circle base	M3CMCB
M3 pedestal table, extra small bar circle base	M3CXSB
M3 pedestal table, small bar circle base	M3CSBB
M3 pedestal table, medium bar circle base	M3CMBB

Base Finish: Powder Coat

DESCRIPTION	CODE
Black Textured	BT
White Textured	WT
Sterling	ST
Matte Mercury	MMR
Matte Mineral	MMN
Matte Burnish	MBN
Matte Foundry	MFN
Matte Blue Sky	MBS
Matte Forest	MFO
Matte Sienna	MSN
Matte Willow	MWL

Top Sizes

ROUND	CODE	SQUARE	CODE	RECTANGLE	CODE
24 DIA	24D	24x24	2424	24x30	2430
30 DIA	30D	30x30	3030		
36 DIA	36D	36x36	3636		
42 DIA	42D	2x42	4242		
48 DIA	48D	48x48	4848		

Top Finish or Color

WOOD TOPS:

STANDARD LELAND COLORS

CUSTOM SPECIFY custom (01)

*Please note that M3 Tables are NOT AVAILABLE in the following finishes:
Natural Walnut Matte (08M), Natural Beech (09), Natural White Oak Matte (12M)

LAMINATE TOPS:

DESCRIPTION	CODE
Grey Laminate Slate Grey Wilsonart®	LGY
Black Laminate Black Pionite®	LBK
White Laminate Designer White Wilsonart®	LWH

Please refer to the Leland Terms and Conditions Guide for a listing of standard laminates.
For table pricing in laminates not listed, please contact Leland's Customer Experience Department for a quotation.

FORBO

DESCRIPTION	CODE
Pearl	4157
Mauve	4172
Pebble	4175
Smokey Blue	4179
Olive	4184

Edge finish options: natural (11) plywood (W2)

Edge Type

VINYL EDGES:

DESCRIPTION	CODE
3/4" flat PVC	V5

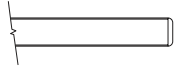

WOOD EDGES:

DESCRIPTION	CODE
1" beveled plywood	W6

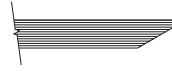

1" flat plywood	W2
-----------------	----

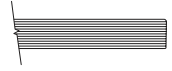

Edge Finish or Color

VINYL EDGE COLORS:

DESCRIPTION	CODE
Black	B
White	W
Grey	G

WOOD EDGE COLORS:

STANDARD LELAND COLORS

CUSTOM SPECIFY Custom (01)

*Please note that M3 Tables are NOT AVAILABLE in the following finishes:
 Natural Walnut Matte (08M), Natural Beech (09), Natural White Oak Matte (12M)

For laminate tops, edge can be specified in any standard Leland finish. Wood tops and edges must be specified in the same standard Leland finish.

Specifications required to create the product code

- Model
- Base Column Finish
- Base Plate Finish
- Top Size
- Top Finish Or Color
- Edge Type
- Edge Finish Or Color



MODEL

M3 Pedestal Table,
Medium Circle Base (M3CMB)

BASE CENTER

White Textured (WT)

TOP SIZE

42" Diameter (42D)

TOP COLOR OR FINISH

White Laminate (LWH)

EDGE TYPE

1" Flat Plywood (W2)

EDGE FINISH OR COLOR

Natural Maple (11)



M3 PEDESTAL TABLE, SMALL SOFT SQUARE BASE
 Design: Leland Design Group

M3T11



**M3 Pedestal Table,
 Powder Coat Base**

	MODEL	TOP SIZE / CODE	LIST PRICE / EDGE CODES:	V5	W6	W2
Small soft square	M3SB-P-P	Wood Top				
		24 DIA - 24D		\$1626	2007	2007
		30 DIA - 30D		\$2120	2716	2716
		24x24 - 2424		\$1626	2007	2007
		30x30 - 3030		\$2120	2716	2716
		24x30 - 2430		\$1841	2348	2348
		Laminate Top				
		24 DIA - 24D		\$1451	1767	1767
		30 DIA - 30D		\$1872	2371	2371
		24x24 - 2424		\$1451	1765	1765
		30x30 - 3030		\$1872	2371	2371
		24x30 - 2430		\$1960	2388	2388
		Forbo Top				
		24 DIA - 24D			\$2105	2105
		30 DIA - 30D			\$2526	2526
		24x24 - 2424			\$2105	2105
		30x30 - 3030			\$2526	2526
		24x30 - 2430			\$2614	2614

H 29



Round

Square

Rectangle

24 DIA

24x24

24x30

30 DIA

30x30

To specify:

Please refer to pages 6-8 for complete specifying information.

Specify all products by their product code.

Pricing Effective: January 2025

M3 PEDESTAL TABLE, MEDIUM SOFT SQUARE BASE
 Design: Leland Design Group

M3T12

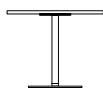

**M3 Pedestal Table,
 Powder Coat Base**

	MODEL	TOP SIZE/CODE	LIST PRICE/EDGE CODES:	V5	W6	W2
Medium soft square	M3MB-P-P	Wood Top				
		36 DIA - 36D		\$2237	2831	2831
H 29		36x36 - 3636		\$2237	2831	2831
		Laminate Top				
		36 DIA - 36D		\$1971	2471	2471
		36x36 - 3636		\$1971	2471	2471
		Forbo Top				
		36 DIA - 36D			\$2625	2625
		36x36 - 3636			\$2625	2625

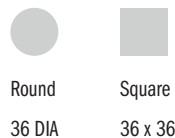

To specify:
 Please refer to pages 6-8 for complete specifying information.
 Specify all products by their product code.

M3 PEDESTAL TABLE, LARGE SOFT SQUARE BASE
 Design: Leland Design Group

M3T13

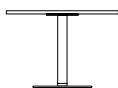

**M3 Pedestal Table,
 Powder Coat Base**

	MODEL	TOP SIZE/CODE	LIST PRICE/EDGE CODES:	V5	W6	W2
Large soft square	M3LB-P-P	Wood Top				
		42 DIA - 42D		\$3064	3660	3660
H 29		42x42 - 4242		\$3064	3660	3660
		Laminate Top				
		42 DIA - 42D		\$2674	3172	3172
		42x42 - 4242		\$2674	3172	3172
		Forbo Top				
		42 DIA - 42D			\$3654	3654
		42x42 - 4242			\$3654	3654

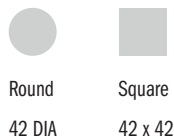

To specify:
 Please refer to pages 6-8 for complete specifying information.
 Specify all products by their product code.

M3 PEDESTAL TABLE, EXTRA LARGE SOFT SQUARE BASE
 Design: Leland Design Group

M3T14



**M3 Pedestal Table,
 Powder Coat Base**

	MODEL	TOP SIZE / CODE	LIST PRICE / EDGE CODES:	V5	W6	W2
Extra large soft square	M3XLB-P-P	Wood Top				
		48 DIA - 48D		\$3189	3724	3660
H 29		48x48 - 4848		\$3129	3724	3660
		Laminate Top				
		48 DIA - 48D		\$2725	3225	3225
		48x48 - 4848		\$2725	3225	3225
		Forbo Top				
		48 DIA - 48D			\$4207	4207
		48x48 - 4848			\$4207	4207

H 29



Round

48 DIA



Square

48 x 48

To specify:

Please refer to pages 6-8 for complete specifying information.

Specify all products by their product code.

Pricing Effective: January 2024

M3 PEDESTAL TABLE, SMALL SOFT SQUARE COUNTER BASE
 Design: Leland Design Group

M3T15



**M3 Pedestal Table,
 Powder Coat Base**

	MODEL	TOP SIZE/CODE	LIST PRICE/EDGE CODES:	V5	W6	W2
Small soft square counter	M3SCB-P-P	Wood Top				
		24 DIA - 24D		\$1700	2082	2082
		30 DIA - 30D		\$2196	2790	2790
		24x24 - 2424		\$1700	2082	2082
		30x30 - 3030		\$2196	2790	2790
		24x30 - 2430		\$1920	2423	2423
		Laminate Top				
		24 DIA - 24D		\$1533	1849	1849
		30 DIA - 30D		\$1954	2453	2453
		24x24 - 2424		\$1533	1849	1849
		30x30 - 3030		\$1954	2453	2453
		24x30 - 2430		\$2041	2468	2468
		Forbo Top				
		24 DIA - 24D			\$2225	2225
		30 DIA - 30D			\$2646	2646
		24x24 - 2424			\$2225	2225
		30x30 - 3030			\$2646	2646
		24x30 - 2430			\$2746	2746

H 36



Round

24 DIA

30 DIA



Square

24 x 24

30 x 30



Rectangle

24 x 30

To specify:

Please refer to pages 6-8 for complete specifying information.

Specify all products by their product code.

M3 PEDESTAL TABLE, LARGE SOFT SQUARE COUNTER BASE
 Design: Leland Design Group

M3T16

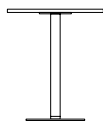

**M3 Pedestal Table,
 Powder Coat Base**

	MODEL	TOP SIZE/CODE	LIST PRICE/EDGE CODES:	V5	W6	W2
Large soft square counter	M3LCB-P-P	Wood Top				
		36 DIA - 36D		\$2305	2907	2907
H 36		36x36 - 3636		\$2305	2907	2907
		Laminate Top				
		36 DIA - 36D		\$2051	2550	2550
		36x36 - 3636		\$2051	2550	2550
		Forbo Top				
		36 DIA - 36D			\$2745	2745
		36x36 - 3636			\$2745	2745

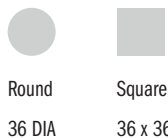

Round Square
 36 DIA 36 x 36

To specify:
 Please refer to pages 6-8 for complete specifying information.
 Specify all products by their product code.

Pricing Effective: January 2025

M3 PEDESTAL TABLE, SMALL SOFT SQUARE BAR BASE
 Design: Leland Design Group

M3T17

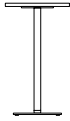

**M3 Pedestal Table,
 Powder Coat Base**

	MODEL	TOP SIZE/CODE	LIST PRICE/EDGE CODES:	V5	W6	W2
Small soft square bar	M3SBB-P-P	Wood Top				
		24 DIA - 24D		\$1772	2154	2154
		30 DIA - 30D		\$2267	2863	2863
		24x24 - 2424		\$1772	2154	2154
		30x30 - 3030		\$2267	2863	2863
		24x30 - 2430		\$1986	2496	2496
		Laminate Top				
		24 DIA - 24D		\$1598	1915	1915
		30 DIA - 30D		\$2020	2519	2519
		24x24 - 2424		\$1598	1915	1915
		30x30 - 3030		\$2020	2519	2519
		24x30 - 2430		\$2106	2534	2534
		Forbo Top				
		24 DIA - 24D			\$2252	2252
		30 DIA - 30D			\$2673	2673
		24x24 - 2424			\$2252	2252
		30x30 - 3030			\$2673	2673
		24x30 - 2430			\$2773	2773

H 42



Round

24 DIA

30 DIA



Square

24 x 24

30 x 30



Rectangle

24 x 30

To specify:

Please refer to pages 6-8 for complete specifying information.

Specify all products by their product code.

M3 PEDESTAL TABLE, LARGE SOFT SQUARE BAR BASE
 Design: Leland Design Group

M3T18

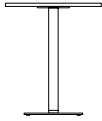

**M3 Pedestal Table,
 Powder Coat Base**

	MODEL	TOP SIZE/CODE	LIST PRICE/EDGE CODES:	V5	W6	W2
Large soft square bar	M3LBB-P-P	Wood Top				
		36 DIA - 36D		\$2383	2979	2979
H 42		36x36 - 3636		\$2383	2979	2979
		Laminate Top				
		36 DIA - 36D		\$2117	2616	2616
		36x36 - 3636		\$2117	2616	2616
		Forbo Top				
		36 DIA - 36D			\$2772	2772
		36x36 - 3636			\$2772	2772

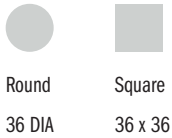

Round Square
 36 DIA 36 x 36

To specify:
 Please refer to pages 6-8 for complete specifying information.
 Specify all products by their product code.

M3 PEDESTAL TABLE, EXTRA SMALL CIRCLE BASE
 Design: Leland Design Group

M3T19



**M3 Pedestal Table,
 Powder Coat Base**

	MODEL	TOP SIZE / CODE	LIST PRICE / EDGE CODES:	V5	W6	W2
Extra small circle	M3CXSB-P-P	Wood Top				
		24 DIA - 24D		\$1626	2007	2007
H 29		24x24 - 2424		\$1626	2007	2007
		Laminate Top				
Round		24 DIA - 24D		\$1451	1767	1767
24 DIA		24x24 - 2424		\$1451	1767	1767
Square		24 x 24				
		Forbo Top				
		24 DIA - 24D			\$2105	2105
		24x24 - 2424			\$2105	2105

To specify:
 Please refer to pages 6-8 for complete specifying information.
 Specify all products by their product code.

M3 PEDESTAL TABLE, SMALL CIRCLE BASE
 Design: Leland Design Group

M3T20



**M3 Pedestal Table,
 Powder Coat Base**

	MODEL	TOP SIZE / CODE	LIST PRICE / EDGE CODES:	V5	W6	W2
Small circle	M3CSB-P-P	Wood Top				
		30 DIA - 30D		\$2120	2716	2716
H 29		24x30 - 2430		\$1841	2348	2348
		Laminate Top				
		30 DIA - 30D		\$1872	2371	2371
		24x30 - 2430		\$1960	2388	2388
		Forbo Top				
		30 DIA - 30D			\$2526	2526
		24x30 - 2430			\$2614	2614

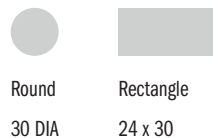

To specify:
 Please refer to pages 6-8 for complete specifying information.
 Specify all products by their product code.

M3 PEDESTAL TABLE, MEDIUM CIRCLE BASE
 Design: Leland Design Group

M3T21



**M3 Pedestal Table,
 Powder Coat Base**

	MODEL	TOP SIZE / CODE	LIST PRICE / EDGE CODES:	V5	W6	W2
Medium circle	M3CMB-P-P	Wood Top				
		36 DIA - 36D		\$2237	2831	2831
H 29		30x30 - 3030		\$2120	2716	2716
		Laminate Top				
		36 DIA - 36D		\$1971	2471	2471
		30x30 - 3030		\$1872	2371	2371
		Forbo Top				
		36 DIA - 36D			\$2625	2625
		30x30 - 3030			\$2526	2526

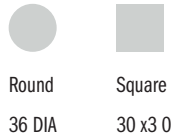

To specify:
 Please refer to pages 6-8 for complete specifying information.
 Specify all products by their product code.

M3 PEDESTAL TABLE, LARGE CIRCLE BASE
 Design: Leland Design Group

M3T22



**M3 Pedestal Table,
 Powder Coat Base**

	MODEL	TOP SIZE / CODE	LIST PRICE / EDGE CODES:	V5	W6	W2
Large circle	M3CLB-P-P	Wood Top				
		42 DIA - 42D		\$3064	3660	3660
H 29		36x36 - 3636		\$2237	2831	2831
		Laminate Top				
Round		42 DIA - 42D		\$2674	3172	3172
42 DIA		36x36 - 3636		\$1971	2471	2471
Square		Forbo Top				
36 x 36		42 DIA - 42D			\$3654	3654
		36x36 - 3636			\$2625	2625

To specify:
 Please refer to pages 6-8 for complete specifying information.
 Specify all products by their product code.

M3 PEDESTAL TABLE, EXTRA LARGE CIRCLE BASE
 Design: Leland Design Group

M3T23

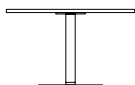

**M3 Pedestal Table,
 Powder Coat Base**

	MODEL	TOP SIZE / CODE	LIST PRICE / EDGE CODES:	V5	W6	W2
Extra large circle	M3CXLB-P-P	Wood Top				
		48 DIA - 48D		\$3189	3724	3660
H 29		42x42 - 4242		\$3064	3660	3660
		Laminate Top				
		48 DIA - 48D		\$2725	3225	3225
		42x42 - 4242		\$2674	3172	3172
		Forbo Top				
		48 DIA - 48D			\$3708	3708
		42x42 - 4242			\$3654	3654

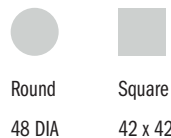

To specify:
 Please refer to pages 6-8 for complete specifying information.
 Specify all products by their product code.

M3 PEDESTAL TABLE, EXTRA-EXTRA LARGE CIRCLE BASE
 Design: Leland Design Group

M3T24

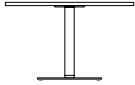

**M3 Pedestal Table,
 Powder Coat Base**

	MODEL	TOP SIZE / CODE	LIST PRICE / EDGE CODES:	V5	W6	W2
Extra-extra large circle	M3CXXLB-P-P	Wood Top				
		48x48 - 4848		\$3129	3724	3660
H 29		Laminate Top				
		48x48 - 4848		\$2725	3225	3225
Square		Forbo Top				
48 x 48		48x48 - 4848			\$3708	3708

To specify:
 Please refer to pages 6-8 for complete specifying information.
 Specify all products by their product code.

M3 PEDESTAL TABLE, EXTRA SMALL CIRCLE
COUNTER BASE

Design: Leland Design Group

M3T25

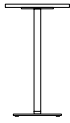

**M3 Pedestal Table,
Powder Coat Base**

	MODEL	TOP SIZE / CODE	LIST PRICE / EDGE CODES:	V5	W6	W2
Extra small circle counter	M3CXSCB-P-P	Wood Top				
		24 DIA - 24D		\$1700	2082	2082
		Laminate Top				
H 36		24 DIA - 24D		\$1533	1849	1849
		Forbo Top				
Circle		24 DIA - 24D			\$2225	2225



Circle
24 DIA



To specify:
Please refer to pages 6-8 for complete specifying information.
Specify all products by their product code.

M3 PEDESTAL TABLE, SMALL CIRCLE COUNTER BASE
 Design: Leland Design Group

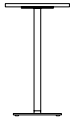
M3T26



**M3 Pedestal Table,
 Powder Coat Base**

	MODEL	TOP SIZE / CODE	LIST PRICE / EDGE CODES:	V5	W6	W2
Small circle counter	M3CSCB-P-P	Wood Top				
		30 DIA - 30D		\$2196	2790	2790
H 36		24x24 - 2424		\$1700	2082	2082
		24x30 - 2430		\$1920	2423	2423
   Round Square Rectangle 30 DIA 24 x 24 24 x 30		Laminate Top				
		30 DIA - 30D		\$1954	2453	2453
		24x24 - 2424		\$1533	1849	1849
		24x30 - 2430		\$2041	2468	2468
		Forbo Top				
		30 DIA - 30D			\$2646	2646
		24x24 - 2424			\$2225	2225
		24x30 - 2430			\$2746	2746

To specify:
 Please refer to pages 6-8 for complete specifying information.
 Specify all products by their product code.

M3 PEDESTAL TABLE, MEDIUM CIRCLE COUNTER BASE
 Design: Leland Design Group

M3T27

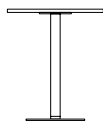

**M3 Pedestal Table,
 Powder Coat Base**

	MODEL	TOP SIZE / CODE	LIST PRICE / EDGE CODES:	V5	W6	W2
Medium circle counter	M3CMCB-P-P	Wood Top				
		30x30 - 3030		\$2196	2790	2790
H 36		Laminate Top				
		30x30 - 3030		\$1954	2453	2453
Square		Forbo Top				
30 x 30		30x30 - 3030			\$2646	2646

To specify:
 Please refer to pages 6-8 for complete specifying information.
 Specify all products by their product code.

M3 PEDESTAL TABLE, EXTRA SMALL CIRCLE BAR BASE
 Design: Leland Design Group

M3T28

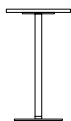

**M3 Pedestal Table,
 Powder Coat Base**

	MODEL	TOP SIZE / CODE	LIST PRICE / EDGE CODES:	V5	W6	W2
Extra small circle bar	M3CXSBP-P-P	Wood Top				
		24 DIA - 24D		\$1772	2154	2154
		Laminate Top				
H 42		24 DIA - 24D		\$1598	1915	1915
		Forbo Top				
Circle		24 DIA - 24D			\$2252	2252

H 42



Circle

24 DIA

To specify:
 Please refer to pages 6-8 for complete specifying information.
 Specify all products by their product code.

M3 PEDESTAL TABLE, SMALL CIRCLE BAR BASE
 Design: Leland Design Group

M3T29

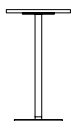

**M3 Pedestal Table,
 Powder Coat Base**

	MODEL	TOP SIZE / CODE	LIST PRICE / EDGE CODES:	V5	W6	W2
Small circle bar	M3CSBB-P-P	Wood Top				
		30 DIA - 30D		\$2267	2863	2863
H 42		24x24 - 2424		\$1772	2154	2154
		24x30 - 2430		\$1986	2496	2496
		Laminate Top				
		30 DIA - 30D		\$2020	2519	2519
		24x24 - 2424		\$1598	1915	1915
		24x30 - 2430		\$2106	2534	2534
		Forbo Top				
		30 DIA - 30D			\$2673	2673
		24x24 - 2424			\$2252	2252
		24x30 - 2430			\$2773	2773

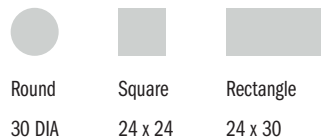

To specify:
 Please refer to pages 6-8 for complete specifying information.
 Specify all products by their product code.

M3 PEDESTAL TABLE, MEDIUM CIRCLE BAR BASE
 Design: Leland Design Group

M3T30

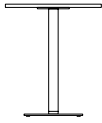

**M3 Pedestal Table,
 Powder Coat Base**

	MODEL	TOP SIZE / CODE	LIST PRICE / EDGE CODES:	V5	W6	W2
Medium circle bar	M3CMBB-P-P	Wood Top				
		30x30 - 3030		\$2267	2863	2863
H 42		Laminate Top				
		30x30 - 3030		\$2020	2519	2519
Square		Forbo Top				
30 x 30		30x30 - 3030			\$2673	2673

To specify:
 Please refer to pages 6-8 for complete specifying information.
 Specify all products by their product code.

5695 Eagle Drive, SE
Grand Rapids,
Michigan 49512
616-975-9260
lelandfurniture.com

Marquette Seating

January 2025 Price List



Marquette Seating

Table of Contents	MQ2
Specification Information	MQ3
Specification Example	MQ4
Stacking Side Chair, Sled Base	MQ5
Counter Chair, Sled Base	MQ6
Bar Chair, Sled Base	MQ7
Marquette Transport/Stacking Dolly	MQ8

Chair Model

SLED BASE:

DESCRIPTION	CODE
Marquette side chair	MQS
Marquette side chair, upholstered seat	MQSU
Marquette counter chair	MQC
Marquette counter chair, upholstered seat	MQCU
Marquette bar chair	MQB
Marquette bar chair, upholstered seat	MQBU

Shell Finish

STANDARD LELAND COLORS

CUSTOM SPECIFY Custom (01)















*Please note that Marquette Chair is NOT AVAILABLE in the following finishes:
 Natural Walnut Matte (08M), Natural Beech (09), Natural White Oak Matte (12M)

Shell Style

SHELL	CODE	SHELL	CODE
Linear	L	Arc	A



Back Cut Out

LINEAR CUT OUTS	CODE	ARC CUT OUTS	CODE
Plain back	1	Plain back	1
Circle 	2	Circle 	2
Diamond 	4	Diamond 	4
Grid 	5	Grid 	5
Perforated 	3	Slotted 	6
Dots 	10	Dots 	10
Squares 	11	Reeds 	13
Reeds 	13	Mosaic 	15
Custom cut out	00	Custom cut out	00

Frame Finish

DESCRIPTION	CODE
Sterling	ST
Black	B
White	W
Warm Grey	WG
Cool Grey	CG
Chrome	C
Matte Blue Sky	MBS
Matte Forest	MFO
Matte Sienna	MSN
Matte Willow	MWL

TEXTURED	CODE
Dolphin Textured	DLT
Oxford Textured	OXT
Black Textured	BT
White Textured	WT

Upholstery Selection

Please refer to Leland Textile Program which features textiles and leathers from the following partners:

- Camira
- Green Hides
- Carnegie
- Maharam
- CF Stinson
- Unika Vaev

The complete grade list can be found on our website or you can specify COM/COL. Due to the design of this product, it is recommended that all non pre-approved textile be tested for compatibility.

Glide Type

STANDARD:	DESCRIPTION	CODE
	Poly	S
OPTIONAL:	DESCRIPTION	CODE
	Felt	F

Specifications required to create the product code

- Model
- Shell Style
- Back Cut Out
- Shell Finish
- Frame Finish
- Upholstery selection (when applicable)
- Glide Type



MODEL

Marquette Side Chair,
Upholstered Seat, Sled Base (MQSU)

SHELL STYLE

Linear (L)

BACK CUT OUT

Grid (5)

SHELL FINISH

Natural (11)

FRAME FINISH

Chrome (C)

UPHOLSTERY

When applicable:
Upholstery— Enter Leland textile code or COM/COL

GLIDE TYPE

Standard Felt (F)



MARQUETTE STACKING SIDE CHAIR, SLED BASE
Design: Leland Design Group

MQ5

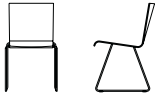

Marquette Side Chair	MODEL	FRAME FINISH	LIST PRICE
Sled base, linear shell	MQS-L	Powder Coat	\$332
W 19.75 D 21 H 34 SH 18.5		Chrome	\$388
Optional Glides: Add \$8.00 net per chair for a set of four (4).			

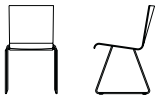

Marquette Side Chair	MODEL	LIST PRICE/GRADE	COM/COL	A	B	C	D	E	F	G	H	I	J	K	L
Sled base, linear shell	MQSU-L	Powder Coat	\$428	453	467	481	495	509	523	537	551	565	579	593	607
upholstered seat onlay		Chrome	\$487	514	527	540	553	566	579	592	605	618	631	644	657
COM Yardage: 1-2 seats: .75 yard; 3-4 seats: 1.25 yards; 5-6 seats: 1.75 yards															
W 19.75 D 21 H 34 SH 18.75	Contact Leland Customer Experience for yardage requirements on textiles with repeats. For COL requirements please contact Leland Customer Experience.														



Marquette Side Chair	MODEL	FRAME FINISH	LIST PRICE
Sled base, arc shell	MQS-A	Powder Coat	\$332
W 19.75 D 21 H 34 SH 18.5		Chrome	\$388
Optional Glides: Add \$8.00 net per chair for a set of four (4).			



Marquette Side Chair	MODEL	LIST PRICE/GRADE	COM/COL	A	B	C	D	E	F	G	H	I	J	K	L
Sled base, arc shell	MQSU-A	Powder Coat	\$428	453	467	481	495	509	523	537	551	565	579	593	607
upholstered seat onlay		Chrome	\$487	514	527	540	553	566	579	592	605	618	631	644	657
COM Yardage: 1-2 seats: .75 yard; 3-4 seats: 1.25 yards; 5-6 seats: 1.75 yards															
W 19.75 D 21 H 34 SH 18.75	Contact Leland Customer Experience for yardage requirements on textiles with repeats. For COL requirements please contact Leland Customer Experience.														

To specify:
Please refer to pages 3-5 for complete specifying information.
Specify all products by their product code.

MARQUETTE COUNTER CHAIR, SLED BASE
Design: Leland Design Group

MQ6

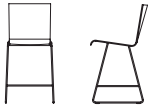

Marquette Counter Chair	MODEL	FRAME FINISH	LIST PRICE
Sled base, linear shell	MQC-L	Powder Coat	\$660
W 19.25 D 22.5 H 39.75 SH 25.25		Chrome	\$739
Optional Glides: Add \$8.00 net per chair for a set of four (4).			

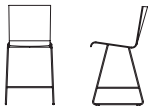

Marquette Counter Chair	MODEL	LIST PRICE/GRADE	COM/COL	A	B	C	D	E	F	G	H	I	J	K	L
Sled base, linear shell	MQCU-L	Powder Coat	\$764	793	805	817	829	841	853	865	877	889	901	913	925
upholstered seat onlay		Chrome	\$844	871	885	899	913	927	941	955	969	983	997	1011	1025
COM Yardage: 1-2 seats: .75 yard; 3-4 seats: 1.25 yards; 5-6 seats: 1.75 yards															
W 19.25 D 22.5 H 39.75 SH 25.25	Contact Leland Customer Experience for yardage requirements on textiles with repeats.														
For COL requirements please contact Leland Customer Experience.															

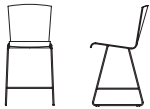

Marquette Counter Chair	MODEL	FRAME FINISH	LIST PRICE
Sled base, arc shell	MQC-A	Powder Coat	\$660
W 19.25 D 22.5 H 39.75 SH 25.25		Chrome	\$739
Optional Glides: Add \$8.00 net per chair for a set of four (4).			



Marquette Counter Chair	MODEL	LIST PRICE/GRADE	COM/COL	A	B	C	D	E	F	G	H	I	J	K	L
Sled base, arc shell	MQCU-A	Powder Coat	\$764	793	805	817	829	841	853	865	877	889	901	913	925
upholstered seat onlay		Chrome	\$844	871	885	899	913	927	941	955	969	983	997	1011	1025
COM Yardage: 1-2 seats: .75 yard; 3-4 seats: 1.25 yards; 5-6 seats: 1.75 yards															
W 19.25 D 22.5 H 39.75 SH 25.25	Contact Leland Customer Experience for yardage requirements on textiles with repeats.														
For COL requirements please contact Leland Customer Experience.															

To specify:
Please refer to pages 3-5 for complete specifying information.
Specify all products by their product code.

Pricing Effective: January 2025

MARQUETTE BAR CHAIR, SLED BASE
 Design: Leland Design Group

MQ7

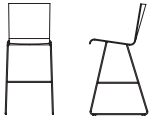

Marquette Bar Chair				MODEL	FRAME FINISH	LIST PRICE
Sled base, linear shell				MQB-L	Powder Coat	\$677
W 19.5	D 23	H 44	SH 30.25		Chrome	\$773

Optional Glides: Add \$8.00 net per chair for a set of four (4).

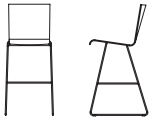

Marquette Bar Chair				MODEL	LIST PRICE/GRADE	COM/COL	A	B	C	D	E	F	G	H	I	J	K	L
Sled base, linear shell				MQBU-L	Powder Coat	\$782	808	822	836	850	864	878	892	906	920	934	948	962
upholstered seat onlay					Chrome	\$879	907	920	933	946	959	972	985	998	1011	1024	1037	1050

COM Yardage: 1-2 seats: .75 yard; 3-4 seats: 1.25 yards; 5-6 seats: 1.75 yards

W 19.5 D 23 H 44 SH 30.5

Contact Leland Customer Experience for yardage requirements on textiles with repeats.

For COL requirements please contact Leland Customer Experience.

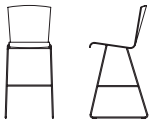

Marquette Bar Chair				MODEL	FRAME FINISH	LIST PRICE
Sled base, arc shell				MQB-A	Powder Coat	\$677
W 19.5	D 23	H 44	SH 30.25		Chrome	\$773

Optional Glides: Add \$8.00 net per chair for a set of four (4).



Marquette Bar Chair				MODEL	LIST PRICE/GRADE	COM/COL	A	B	C	D	E	F	G	H	I	J	K	L
Sled base, arc shell				MQBU-A	Powder Coat	\$782	808	822	836	850	864	878	892	906	920	934	948	962
upholstered seat onlay					Chrome	\$879	907	920	933	946	959	972	985	998	1011	1024	1037	1050

COM Yardage: 1-2 seats: .75 yard; 3-4 seats: 1.25 yards; 5-6 seats: 1.75 yards

W 19.5 D 23 H 44 SH 30.5

Contact Leland Customer Experience for yardage requirements on textiles with repeats.

For COL requirements please contact Leland Customer Experience.

To specify:
 Please refer to pages 3-5 for complete specifying information.
 Specify all products by their product code.

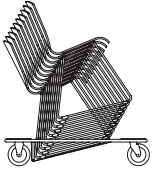

**Marquette Transport/
 Stacking Dolly**

			MODEL	FRAME FINISH	LIST PRICE
W 23	D 33	H 6 (empty)	MQD	Powder Coat	\$1180
W 23	D 33	H 38		Marquette Transport/Stacking Dolly handles up to 10 Marquette side chairs.	
(with 10 side chairs)				Little Marquette chairs do not stack on dolly.	

**PROPER STACKING OF MARQUETTE SLED BASE CHAIRS
 (10 CHAIRS MAXIMUM)**

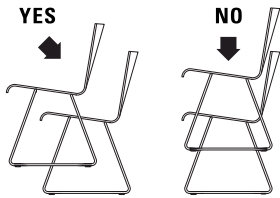

To specify:
 Please refer to pages 3-5 for complete specifying information.
 Specify all products by their product code.

5695 Eagle Drive, SE
Grand Rapids,
Michigan 49512
616-975-9260
lelandfurniture.com

Mass

January 2025 Price List



Mass

Table of Contents	MA2
Specification Information	MA3
Specification Example	MA4
Stacking Side Chair	MA5
Stacking Side Chair, Upholstered Seat	MA6
Stacking Arm Chair	MA7
Stacking Arm Chair, Upholstered Seat	MA8
Stacking Counter Chair	MA9
Stacking Counter Chair, Upholstered Seat	MA10
Stacking Bar Chair	MA11
Stacking Bar Chair, Upholstered Seat	MA12
Transport/Stacking Dolly	MA13
Ganging Device	MA13

Chair Model

DESCRIPTION	CODE
Mass stacking side chair	MASS
Mass stacking side chair, upholstered seat	MASSU
Mass stacking arm chair	MASA
Mass stacking arm chair, upholstered seat	MASAU
Mass stacking counter chair	MASC
Mass stacking counter chair, upholstered seat	MASCU
Mass stacking bar chair	MASB
Mass stacking bar chair, upholstered seat	MASBU
Mass transport/stacking dolly	MASD

Seat/Back Color

POLYPROPYLENE SHELL:

DESCRIPTION	CODE
White	WT
Black	BK
Dolphin	DL
Pistachio	PS

CUSTOM POLYPROPYLENE COLORS

Custom color match is available upon request. Please contact hello@lelandfurniture.com for further information

Onlay Selection

Please refer to Leland Textile Program which features textiles and leathers from the following partners:

- [Pre-approved Textiles](#)

The complete grade list can be found at www.lelandfurniture.com/resources or you can specify COM/COL. Due to the design of this product, it is recommended that all non pre-approved textile be tested for compatibility.

Frame Finish

DESCRIPTION	CODE
Chrome	C
Matte Pistachio	MPS
Sterling	ST
Dolphin Textured	DLT
White Textured	WT
Black Textured	BT

Glide Type

STANDARD:

DESCRIPTION	CODE
Nylon	S

OPTIONAL:

DESCRIPTION	CODE
Felt	F

Stacking Note

Mass side chair, arm chair and bar chair models stack as follows (includes upholstered):

SIDE CHAIR:

Floor: 15 High
Dolly: 40 High

ARM CHAIR:

Floor: 12 High
Dolly: 40 High

BAR & COUNTER CHAIR:

Floor: 8 High

Chair Weight

SIDE CHAIR: 12 lbs

ARM CHAIR: 14 lbs

Specifications required to create the product code

- Model
- Shell Finish
- Upholstered Onlay Selection (when applicable)
- Frame Finish
- Glide or Caster Type

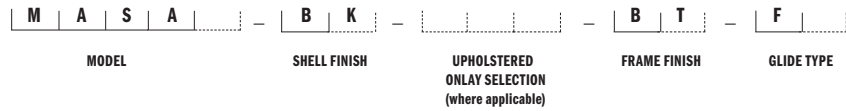

MODEL

Mass stacking arm chair (MASA)

SHELL FINISH

Black (BK)

UPHOLSTERED ONLAY SELECTION

When applicable, enter upholstery grade, COM



FRAME FINISH

Black Textured (BT)

GLIDE TYPE

Optional Felt (F)



MASS STACKING SIDE CHAIR
 Design: ITEMdesignworks, licensed by Sellex

MA5



PRICING FOR QUANTITIES 1-99

Mass Stacking Side Chair	MODEL	FRAME FINISH	LIST PRICE
Polypropylene shell	MASS	Powder Coat	\$386
W 20.5 D 20.5 H 32.25 SH 18		Chrome	\$453

Optional Glides: Add \$8.00 net per chair for a set of four (4).



PRICING FOR QUANTITIES 100-299

Mass Stacking Side Chair	MODEL	FRAME FINISH	LIST PRICE
Polypropylene shell	MASS	Powder Coat	\$370
W 20.5 D 20.5 H 32.25 SH 18		Chrome	\$428

Optional Glides: Add \$8.00 net per chair for a set of four (4).



PRICING FOR QUANTITIES 300+

Mass Stacking Side Chair	MODEL	FRAME FINISH	LIST PRICE
Polypropylene shell	MASS	Powder Coat	\$346
W 20.5 D 20.5 H 32.25 SH 18		Chrome	\$405

Optional Glides: Add \$8.00 net per chair for a set of four (4).

To specify:
 Please refer to pages 3-4 for complete specifying information.
 Specify all products by their product code.

Pricing Effective: January 2025

MASS STACKING SIDE CHAIR, UPHOLSTERED SEAT
 Design: ITEMdesignworks, licensed by Sellex

MA6



PRICING FOR QUANTITIES 1-99

Mass Stacking Side Chair	MODEL	LIST PRICE/GRADE	COM/COL	A	B	C	D	E	F	G	H	I	J	K	L
Polypropylene shell, upholstered seat onlay	MASSU	Powder Coat	\$534	570	605	640	675	710	745	780	815	850	885	920	955
		Chrome	\$599	635	671	707	743	779	815	851	887	923	959	995	1031
W 20.5 D 20.5 H 32.25 SH 18															

COM Yardage: 1-3 seats: .5 yard

Contact Leland Customer Experience for yardage requirements on textiles with repeats.

For COL requirements please contact Leland Customer Experience.

Optional Glides: Add \$8.00 net per chair for a set of four (4).



PRICING FOR QUANTITIES 100-299

Mass Stacking Side Chair	MODEL	LIST PRICE/GRADE	COM/COL	A	B	C	D	E	F	G	H	I	J	K	L
Polypropylene shell, upholstered seat onlay	MASSU	Powder Coat	\$503	539	575	611	647	683	719	755	791	827	863	899	935
		Chrome	\$564	601	637	673	709	745	781	817	853	889	925	961	997
W 20.5 D 20.5 H 32.25 SH 18															

COM Yardage: 1-3 seats: .5 yard

Contact Leland Customer Experience for yardage requirements on textiles with repeats.

For COL requirements please contact Leland Customer Experience.

Optional Glides: Add \$8.00 net per chair for a set of four (4).



PRICING FOR QUANTITIES 300+

Mass Stacking Side Chair	MODEL	LIST PRICE/GRADE	COM/COL	A	B	C	D	E	F	G	H	I	J	K	L
Polypropylene shell, upholstered seat onlay	MASSU	Powder Coat	\$475	511	547	583	619	655	691	727	763	799	835	871	907
		Chrome	\$535	571	606	641	676	711	746	781	816	851	886	921	956
W 20.5 D 20.5 H 32.25 SH 18															

COM Yardage: 1-3 seats: .5 yard

Contact Leland Customer Experience for yardage requirements on textiles with repeats.

For COL requirements please contact Leland Customer Experience.

Optional Glides: Add \$8.00 net per chair for a set of four (4).

To specify:
 Please refer to pages 3-4 for complete specifying information.
 Specify all products by their product code.

MASS STACKING ARM CHAIR
 Design: ITEMdesignworks, licensed by Sellex

MA7



PRICING FOR QUANTITIES 1-99

Mass Stacking Arm Chair	MODEL	FRAME FINISH	LIST PRICE
Polypropylene shell	MASA	Powder Coat	\$536
W 20.5 D 20.5 H 32.25 SH 18		Chrome	\$600

Optional Glides: Add \$8.00 net per chair for a set of four (4).



PRICING FOR QUANTITIES 100-299

Mass Stacking Arm Chair	MODEL	FRAME FINISH	LIST PRICE
Polypropylene shell	MASA	Powder Coat	\$503
W 20.5 D 20.5 H 32.25 SH 18		Chrome	\$571

Optional Glides: Add \$8.00 net per chair for a set of four (4).



PRICING FOR QUANTITIES 300+

Mass Stacking Arm Chair	MODEL	FRAME FINISH	LIST PRICE
Polypropylene shell	MASA	Powder Coat	\$476
W 20.5 D 20.5 H 32.25 SH 18		Chrome	\$535

Optional Glides: Add \$8.00 net per chair for a set of four (4).

To specify:
 Please refer to pages 3-4 for complete specifying information.
 Specify all products by their product code.

Pricing Effective: January 2025

MASS STACKING ARM CHAIR, UPHOLSTERED SEAT
 Design: ITEMdesignworks, licensed by Sellex

MA8



PRICING FOR QUANTITIES 1-99

Mass Stacking Arm Chair	MODEL	LIST PRICE/GRADE	COM/COL	A	B	C	D	E	F	G	H	I	J	K	L
Polypropylene shell, upholstered seat onlay	MASAU	Powder Coat	\$624	661	696	731	766	801	836	871	906	941	976	1011	1046
		Chrome	\$693	729	765	801	837	873	909	945	981	1017	1053	1089	1125
W 20.5 D 20.5 H 32.25 SH 18	COM Yardage: 1-3 seats: .5 yard														
Contact Leland Customer Experience for yardage requirements on textiles with repeats.															
For COL requirements please contact Leland Customer Experience.															
Optional Glides: Add \$8.00 net per chair for a set of four (4).															



PRICING FOR QUANTITIES 100-299

Mass Stacking Arm Chair	MODEL	LIST PRICE/GRADE	COM/COL	A	B	C	D	E	F	G	H	I	J	K	L
Polypropylene shell, upholstered seat onlay	MASAU	Powder Coat	\$589	626	662	698	734	770	806	842	878	914	950	986	1022
		Chrome	\$655	691	727	763	799	835	871	907	943	979	1015	1051	1087
W 20.5 D 20.5 H 32.25 SH 18	COM Yardage: 1-3 seats: .5 yard														
Contact Leland Customer Experience for yardage requirements on textiles with repeats.															
For COL requirements please contact Leland Customer Experience.															
Optional Glides: Add \$8.00 net per chair for a set of four (4).															



PRICING FOR QUANTITIES 300+

Mass Stacking Arm Chair	MODEL	LIST PRICE/GRADE	COM/COL	A	B	C	D	E	F	G	H	I	J	K	L
Polypropylene shell, upholstered seat onlay	MASAU	Powder Coat	\$557	593	628	663	698	733	768	803	838	873	908	943	978
		Chrome	\$618	653	689	725	761	797	833	869	905	941	977	1013	1049
W 20.5 D 20.5 H 32.25 SH 18	COM Yardage: 1-3 seats: .5 yard														
Contact Leland Customer Experience for yardage requirements on textiles with repeats.															
For COL requirements please contact Leland Customer Experience.															
Optional Glides: Add \$8.00 net per chair for a set of four (4).															

To specify:
 Please refer to pages 3-4 for complete specifying information.
 Specify all products by their product code.

MASS STACKING COUNTER CHAIR
 Design: ITEMdesignworks, licensed by Sellex

MA9



PRICING FOR QUANTITIES 1-99

Mass Stacking Counter Chair	MODEL	FRAME FINISH	LIST PRICE
Polypropylene shell	MASC	Powder Coat	\$691
W 21.75 D 20.5 H 40.75 SH 25		Chrome	\$758

Optional Glides: Add \$8.00 net per chair for a set of four (4).



PRICING FOR QUANTITIES 100-299

Mass Stacking Counter Chair	MODEL	FRAME FINISH	LIST PRICE
Polypropylene shell	MASC	Powder Coat	\$653
W 21.75 D 20.5 H 40.75 SH 25		Chrome	\$717

Optional Glides: Add \$8.00 net per chair for a set of four (4).



PRICING FOR QUANTITIES 300+

Mass Stacking Counter Chair	MODEL	FRAME FINISH	LIST PRICE
Polypropylene shell	MASC	Powder Coat	\$616
W 21.75 D 20.5 H 40.75 SH 25		Chrome	\$654

Optional Glides: Add \$8.00 net per chair for a set of four (4).

To specify:
 Please refer to pages 3-4 for complete specifying information.
 Specify all products by their product code.

Pricing Effective: January 2025

MASS STACKING COUNTER CHAIR, UPHOLSTERED SEAT
 Design: ITEMdesignworks, licensed by Sellex

MA10



PRICING FOR QUANTITIES 1-99

Mass Stacking Counter Chair	MODEL	LIST PRICE/GRADE	COM/COL	A	B	C	D	E	F	G	H	I	J	K	L
Polypropylene shell, upholstered seat onlay	MASCU	Powder Coat	\$829	865	899	933	967	1001	1035	1069	1103	1137	1171	1205	1239
		Chrome	\$897	932	966	1000	1034	1068	1102	1136	1170	1204	1238	1272	1306

W 21.75 D 20.5 H 40.75 SH 25

COM Yardage: 1-3 seats: .5 yard
 Contact Leland Customer Experience for yardage requirements on textiles with repeats.
 For COL requirements please contact Leland Customer Experience.
 Optional Glides: Add \$8.00 net per chair for a set of four (4).

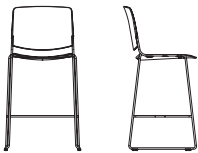

PRICING FOR QUANTITIES 100-299

Mass Stacking Counter Chair	MODEL	LIST PRICE/GRADE	COM/COL	A	B	C	D	E	F	G	H	I	J	K	L
Polypropylene shell, upholstered seat onlay	MASCU	Powder Coat	\$783	818	852	886	920	954	988	1022	1056	1090	1124	1158	1192
		Chrome	\$848	883	917	951	985	1019	1053	1087	1121	1155	1189	1223	1257

W 21.75 D 20.5 H 40.75 SH 25

COM Yardage: 1-3 seats: .5 yard
 Contact Leland Customer Experience for yardage requirements on textiles with repeats.
 For COL requirements please contact Leland Customer Experience.
 Optional Glides: Add \$8.00 net per chair for a set of four (4).



PRICING FOR QUANTITIES 300+

Mass Stacking Counter Chair	MODEL	LIST PRICE/GRADE	COM/COL	A	B	C	D	E	F	G	H	I	J	K	L
Polypropylene shell, upholstered seat onlay	MASCU	Powder Coat	\$737	772	806	840	874	908	942	976	1010	1044	1078	1112	1146
		Chrome	\$797	831	866	901	936	971	1006	1041	1076	1111	1146	1181	1216

W 21.75 D 20.5 H 40.75 SH 25

COM Yardage: 1-3 seats: .5 yard
 Contact Leland Customer Experience for yardage requirements on textiles with repeats.
 For COL requirements please contact Leland Customer Experience.
 Optional Glides: Add \$8.00 net per chair for a set of four (4).

To specify:
 Please refer to pages 3-4 for complete specifying information.
 Specify all products by their product code.

MASS STACKING BAR CHAIR
 Design: ITEMdesignworks, licensed by Sellex

MA11



PRICING FOR QUANTITIES 1-99

Mass Stacking Bar Chair	MODEL	FRAME FINISH	LIST PRICE
Polypropylene shell	MASB	Powder Coat	\$713
W 21.75 D 20.5 H 40.75 SH 29		Chrome	\$782

Optional Glides: Add \$8.00 net per chair for a set of four (4).



PRICING FOR QUANTITIES 100-299

Mass Stacking Bar Chair	MODEL	FRAME FINISH	LIST PRICE
Polypropylene shell	MASB	Powder Coat	\$674
W 21.75 D 20.5 H 40.75 SH 29		Chrome	\$739

Optional Glides: Add \$8.00 net per chair for a set of four (4).



PRICING FOR QUANTITIES 300+

Mass Stacking Bar Chair	MODEL	FRAME FINISH	LIST PRICE
Polypropylene shell	MASB	Powder Coat	\$633
W 21.75 D 20.5 H 40.75 SH 29		Chrome	\$675

Optional Glides: Add \$8.00 net per chair for a set of four (4).

To specify:
 Please refer to pages 3-4 for complete specifying information.
 Specify all products by their product code.

Pricing Effective: January 2025

MASS STACKING BAR CHAIR, UPHOLSTERED SEAT
 Design: ITEMdesignworks, licensed by Sellex

MA12



PRICING FOR QUANTITIES 1-99

Mass Stacking Bar Chair

	MODEL	LIST PRICE/GRADE	COM/COL	A	B	C	D	E	F	G	H	I	J	K	L
Polypropylene shell, upholstered seat onlay	MASBU	Powder Coat	\$856	892	928	964	1000	1036	1072	1108	1144	1180	1216	1252	1288
		Chrome	\$924	961	997	1033	1069	1105	1141	1177	1213	1249	1285	1321	1357

W 21.75 D 20.5 H 40.75 SH 29

COM Yardage: 1-3 seats: .5 yard
 Contact Leland Customer Experience for yardage requirements on textiles with repeats.
 For COL requirements please contact Leland Customer Experience.
 Optional Glides: Add \$8.00 net per chair for a set of four (4).



PRICING FOR QUANTITIES 100-299

Mass Stacking Bar Chair

	MODEL	LIST PRICE/GRADE	COM/COL	A	B	C	D	E	F	G	H	I	J	K	L
Polypropylene shell, upholstered seat onlay	MASBU	Powder Coat	\$806	842	878	914	950	986	1022	1058	1094	1130	1166	1202	1238
		Chrome	\$874	910	946	982	1018	1054	1090	1126	1162	1198	1234	1270	1306

W 21.75 D 20.5 H 40.75 SH 29

COM Yardage: 1-3 seats: .5 yard
 Contact Leland Customer Experience for yardage requirements on textiles with repeats.
 For COL requirements please contact Leland Customer Experience.
 Optional Glides: Add \$8.00 net per chair for a set of four (4).

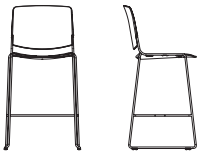

PRICING FOR QUANTITIES 300+

Mass Stacking Bar Chair

	MODEL	LIST PRICE/GRADE	COM/COL	A	B	C	D	E	F	G	H	I	J	K	L
Polypropylene shell, upholstered seat onlay	MASBU	Powder Coat	\$760	796	831	866	901	936	971	1006	1041	1076	1111	1146	1181
		Chrome	\$823	859	894	929	964	999	1034	1069	1104	1139	1174	1209	1244

W 21.75 D 20.5 H 40.75 SH 29

COM Yardage: 1-3 seats: .5 yard
 Contact Leland Customer Experience for yardage requirements on textiles with repeats.
 For COL requirements please contact Leland Customer Experience.
 Optional Glides: Add \$8.00 net per chair for a set of four (4).

To specify:
 Please refer to pages 3-4 for complete specifying information.
 Specify all products by their product code.

MASS TRANSPORT/STACKING DOLLY
 Design: ITEMdesignworks, licensed by Sellex

MA13



Mass Transport/Stacking Dolly	MODEL	FRAME FINISH	LIST PRICE
Black powder coat finish	MASD		\$1140
W 34.5 D 23 H 17 (Dimensions of dolly when empty)		Mass Transport/Stacking Dolly capacity: 40 high (15 high on floor) Weight with 40 high on dolly: 565 lbs	
W 41.25 D 23 H 65.25 (Dimensions with 40 poly chair stack)		For use with Side and Arm Chair models (including upholstered) **Bar and Counter models do no stack on dolly	

MASS AUXILIARY OPTIONS
 Design: ITEMdesignworks, licensed by Sellex



Ganging Device	MODEL	LIST PRICE
Two per set	GD	\$57
Available for all models **Only comes in black		

To specify:
 Please refer to pages 3-4 for complete specifying information.
 Specify all products by their product code.

Pricing Effective: January 2025

5695 Eagle Drive, SE
Grand Rapids,
Michigan 49512
616-975-9260
lelandfurniture.com

Omena

January 2025 Price List



Omena

Table of Contents	OM2
Specification Information	OM3
Specification Example	OM4
Side Chair	OM5
Counter Stool	OM7
Bar Stool	OM8
Low Stool	OM9

Chair Model

DESCRIPTION	CODE
Omena side chair	OMSW
Omena side chair, upholstered seat	OMSWU
Omena side chair, upholstered seat and back	OMSWUU
Omena counter stool	OMCW
Omena counter stool, upholstered seat	OMCWU
Omena bar stool	OMBW
Omena bar stool, upholstered seat	OMBWU
Omena low stool	OMLW
Omena low stool, upholstered seat	OMLWU

Shell Veneer

DESCRIPTION	CODE
Maple (standard)	M
Oak (premium)	O

Shell Leg/Finish

STANDARD SHELL/LEG (MAPLE):

STANDARD LELAND COLORS

CUSTOM SPECIFY Custom (01)

OAK SHELL/BASE:

DESCRIPTION	CODE
Morel	66M
Weathered	68M
Dune	69M
Trillium	70M

GRADIENT FINISHES

DESCRIPTION	CODE
Blue Sky Gradient BG	90MG
Forest Gradient FG	86MG
Gravel Gradient GG	87MG
Dawn Gradient DG	88MG
Heather Gradient HG	99MG

Gradient Finishes applied on maple shell/leg only and are only offered on Omena side chair and low stool.

Upholstery Selection

Please refer to Leland Textile Program which features textiles and leathers from the following partners:

- Camira
- Green Hides
- Carnegie
- Maharam
- CF Stinson
- Unika Vaev

The complete grade list can be found on our website or you can specify COM/COL. Due to the design of this product, it is recommended that all non pre-approved textile be tested for compatibility.

Glide Type

STANDARD:

DESCRIPTION	CODE
Nylon	S

OPTIONAL:

Please note that optional glides raise the chair height .5 inch.

DESCRIPTION	CODE
Rubber	R
Felt	FC

Stacking note

The Omena chair/stool does not stack.

Specifications required to create the product code

- Model
- Wood Species
- Shell Finish
- Seat Upholstery Selection (when applicable)
- Leg Finish
- Back Upholstery Selection (when applicable)
- Glide Type

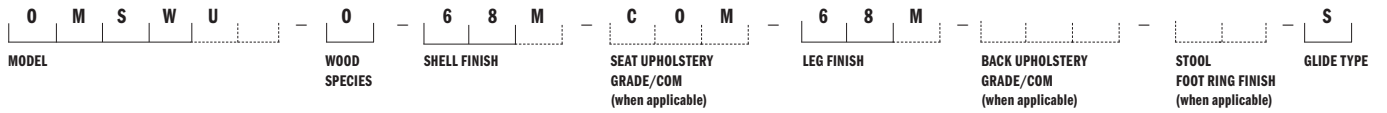

MODEL

Omena Side Chair, Upholstered Seat (OMSWU)

WOOD SPECIES

Oak (O)

SHELL FINISH

Weathered (68M)

SEAT UPHOLSTERY SELECTION

When applicable, enter upholstery grade, COM

LEG FINISH

Weathered (68M)

BACK UPHOLSTERY SELECTION

When applicable, enter upholstery grade, COM



OMENA SIDE CHAIR
 Design: 2B Studio, Will Oltman

OM5



Omena Side Chair	MODEL	LIST PRICE
Maple shell/base	OMSW-M	\$859
W 17.5 D 21 H 31 SH 18		

Optional Glides: Add \$8.00 net per chair for a set of four (4). Optional Glides raise chair height .5 inch.
 Gradient Finishes Upcharge: \$168 List



Omena Side Chair	MODEL	LIST PRICE/GRADE	COM/COL	A	B	C	D	E	F	G	H	I	J	K	L
Maple shell/base, upholstered seat	OMSWU-M		\$1007	1050	1072	1094	1116	1138	1160	1182	1204	1226	1248	1270	1292
W 17.5 D 21 H 31 SH 18.5															

Optional Glides: Add \$8.00 net per chair for a set of four (4). Optional Glides raise chair height .5 inch.
 Gradient Finishes Upcharge: \$168 List
 COM Yardage: 0.5 yards, 1-2 seats
 Contact Leland Customer Experience for yardage requirements on textiles with repeats.
 For COL requirements please contact Leland Customer Experience.



Omena Side Chair	MODEL	LIST PRICE/GRADE	COM/COL	A	B	C	D	E	F	G	H	I	J	K	L
Maple shell/base, upholstered seat and back	OMSWUU-M		\$1158	1244	1287	1330	1373	1416	1459	1502	1545	1588	1631	1674	1717
W 17.5 D 21 H 31 SH 18.5															

Optional Glides: Add \$8.00 net per chair for a set of four (4). Optional Glides raise chair height .5 inch.
 Gradient Finishes Upcharge: \$168 List
 COM Yardage: 1 yard, 1-2 seat and backs
 Contact Leland Customer Experience for yardage requirements on textiles with repeats.
 For COL requirements please contact Leland Customer Experience.

To specify:
 Please refer to pages 3-4 for complete specifying information.
 Specify all products by their product code.

OMENA SIDE CHAIR
Design: 2B Studio, Will Oltman

OM6



Omena Side Chair				MODEL	LIST PRICE
Oak shell/base				OMSW-0	\$955
W 17.5	D 21	H 31	SH 18	Optional Glides: Add \$8.00 net per chair for a set of four (4). Optional Glides raise chair height .5 inch. Gradient Finishes Upcharge: \$168 List	



Omena Side Chair				MODEL	LIST PRICE/GRADE	COM/COL	A	B	C	D	E	F	G	H	I	J	K	L
Oak shell/base, upholstered seat				OMSWU-0	\$1106		1148	1170	1192	1214	1236	1258	1280	1302	1324	1346	1368	1390
W 17.5	D 21	H 31	SH 18.5	Optional Glides: Add \$8.00 net per chair for a set of four (4). Optional Glides raise chair height .5 inch. COM Yardage: 0.5 yards, 1-2 seats Contact Leland Customer Experience for yardage requirements on textiles with repeats. For COL requirements please contact Leland Customer Experience.														



Omena Side Chair				MODEL	LIST PRICE/GRADE	COM/COL	A	B	C	D	E	F	G	H	I	J	K	L
Oak shell/base, upholstered seat and back				OMSWUU-0	\$1255		1340	1385	1430	1475	1520	1565	1610	1655	1700	1745	1790	1835
W 17.5	D 21	H 31	SH 18.5	Optional Glides: Add \$8.00 net per chair for a set of four (4). Optional Glides raise chair height .5 inch. COM Yardage: 1 yard, 1-2 seat and backs Contact Leland Customer Experience for yardage requirements on textiles with repeats. For COL requirements please contact Leland Customer Experience.														

To specify:
Please refer to pages 3-4 for complete specifying information.
Specify all products by their product code.

OMENA COUNTER STOOL
Design: 2B Studio, Will Oltman

OM7



Omena Counter Stool		MODEL	LIST PRICE
Maple shell/base		OMCW-M	\$1373
W 17.5	D 21	H 25	SH 24
Optional Glides: Add \$8.00 net per chair for a set of four (4). Optional Glides raise chair height .5 inch.			



Omena Counter Stool		MODEL	LIST PRICE/GRADE	COM/COL	A	B	C	D	E	F	G	H	I	J	K	L
Maple shell/base, upholstered seat		OMCWU-M		\$1500	1543	1565	1587	1609	1631	1653	1675	1697	1719	1741	1763	1785
W 17.5	D 21	H 25.75	SH 24.75	Optional Glides: Add \$8.00 net per chair for a set of four (4). Optional Glides raise chair height .5 inch.												
COM Yardage: 0.75 yards for 1-2 seats				Contact Leland Customer Experience for yardage requirements on textiles with repeats.												
				For COL requirements please contact Leland Customer Experience.												



Omena Counter Stool		MODEL	LIST PRICE
Oak shell/base		OMCW-O	\$1537
W 17.5	D 21	H 25	SH 24
Optional Glides: Add \$8.00 net per chair for a set of four (4). Optional Glides raise chair height .5 inch.			



Omena Counter Stool		MODEL	LIST PRICE/GRADE	COM/COL	A	B	C	D	E	F	G	H	I	J	K	L
Oak shell/base, upholstered seat		OMCWU-O		\$1667	1709	1730	1751	1772	1793	1814	1835	1856	1877	1898	1919	1940
W 17.5	D 21	H 25.75	SH 24.75	Optional Glides: Add \$8.00 net per chair for a set of four (4). Optional Glides raise chair height .5 inch.												
COM Yardage: 0.75 yards for 1-2 seats				Contact Leland Customer Experience for yardage requirements on textiles with repeats.												
				For COL requirements please contact Leland Customer Experience.												

To specify:
Please refer to pages 3-4 for complete specifying information.
Specify all products by their product code.

Pricing Effective: January 2025

OMENA BAR STOOL
Design: 2B Studio, Will Oltman

OM8



Omena Bar Stool	MODEL	LIST PRICE
Maple shell/base	OMBW-M	\$1614
W 17.5 D 21 H 31 SH 30	Optional Glides: Add \$8.00 net per chair for a set of four (4). Optional Glides raise chair height .5 inch.	



Omena Bar Stool	MODEL	LIST PRICE/GRADE	COM/COL	A	B	C	D	E	F	G	H	I	J	K	L
Maple shell/base, upholstered seat	OMBWU-M	\$1763	1807	1828	1849	1870	1891	1912	1933	1954	1975	1996	2017	2038	
W 17.5 D 21 H 31.75 SH 30.75	Optional Glides: Add \$8.00 net per chair for a set of four (4). Optional Glides raise chair height .5 inch.														
	COM Yardage: 0.75 yards for 1-2 seats														
	Contact Leland Customer Experience for yardage requirements on textiles with repeats.														
	For COL requirements please contact Leland Customer Experience.														



Omena Bar Stool	MODEL	LIST PRICE
Oak shell/base	OMBW-O	\$1809
W 17.5 D 21 H 31 SH 30	Optional Glides: Add \$8.00 net per chair for a set of four (4). Optional Glides raise chair height .5 inch.	



Omena Bar Stool	MODEL	LIST PRICE/GRADE	COM/COL	A	B	C	D	E	F	G	H	I	J	K	L
Oak shell/base, upholstered seat	OMBWU-O	\$1958	2001	2023	2045	2067	2089	2111	2133	2155	2177	2199	2221	2243	
W 17.5 D 21 H 31.75 SH 30.75	Optional Glides: Add \$8.00 net per chair for a set of four (4). Optional Glides raise chair height .5 inch.														
	COM Yardage: 0.75 yards for 1-2 seats														
	Contact Leland Customer Experience for yardage requirements on textiles with repeats.														
	For COL requirements please contact Leland Customer Experience.														

To specify:
Please refer to pages 3-4 for complete specifying information.
Specify all products by their product code.

OMENA BAR STOOL
Design: 2B Studio, Will Oltman

OM9



Omema Low Stool	MODEL	LIST PRICE
Maple shell/base	OMLW-M	\$1314
W 16.5 D 12.09 H 19 SH 18		
Optional Glides: Add \$8.00 net per chair for a set of four (4). Optional Glides raise chair height .5 inch.		
Gradient Finishes Upcharge: \$168 List		



Omema Low Stool	MODEL	LIST PRICE/GRADE	COM/COL	A	B	C	D	E	F	G	H	I	J	K	L
Maple shell/base, upholstered seat	OMLWU-M		\$1441	1483	1506	1529	1552	1575	1598	1621	1644	1667	1690	1713	1736
W 17.83 D 13.53 H 19.75 SH 18.75															
Optional Glides: Add \$8.00 net per chair for a set of four (4). Optional Glides raise chair height .5 inch.															
Gradient Finishes Upcharge: \$168 List															
COM Yardage: 0.75 yards for 1-2 seats															
Contact Leland Customer Experience for yardage requirements on textiles with repeats.															
For COL requirements please contact Leland Customer Experience.															



Omema Low Stool	MODEL	LIST PRICE
Oak shell/base	OMLW-O	\$1477
W 16.5 D 12.09 H 19 SH 18		
Optional Glides: Add \$8.00 net per chair for a set of four (4). Optional Glides raise chair height .5 inch.		



Omema Low Stool	MODEL	LIST PRICE/GRADE	COM/COL	A	B	C	D	E	F	G	H	I	J	K	L
Oak shell/base, upholstered seat	OMLWU-O		\$1606	1649	1671	1693	1715	1737	1759	1781	1803	1825	1847	1869	1891
W 17.83 D 13.53 H 19.75 SH 18.75															
Optional Glides: Add \$8.00 net per chair for a set of four (4). Optional Glides raise chair height .5 inch.															
COM Yardage: 0.75 yards for 1-2 seats															
Contact Leland Customer Experience for yardage requirements on textiles with repeats.															
For COL requirements please contact Leland Customer Experience.															

To specify:
Please refer to pages 3-4 for complete specifying information.
Specify all products by their product code.

**5695 Eagle Drive, SE
Grand Rapids,
Michigan 49512
616-975-9260
lelandfurniture.com**

Parfait II

January 2025 Price List



Parfait II

Table of Contents	PII2
Specification Information	PII3
Specification Example	PII4
Stacking Side Chair	PII5
Non-Stacking Side Chair	PII6
Mobile Stacking Side Chair	PII7
Mobile Non-Stacking Side Chair	PII9
Arm Chair	PII11
Mobile Arm Chair	PII12
Counter Chair	PII14
Bar Chair	PII15
Transport/Stacking Dolly	PII16

Chair Model

STACKING SIDE CHAIR:

DESCRIPTION	CODE
upholstered seat, wood back	PSSUW
wood seat, wood back	PSSWW
upholstered seat, wood back, upholstered back onlay	PSSUWU

SIDE CHAIR:

DESCRIPTION	CODE
upholstered seat, wood back	PSUW
wood seat, wood back	PSWW
upholstered seat, wood back, upholstered back onlay	PSUWU

ARM CHAIR:

DESCRIPTION	CODE
upholstered seat, wood back, polypropylene arm cap	PAUW
wood seat, wood back, polypropylene arm cap	PAWW
upholstered seat, wood back	
upholstered back onlay, polypropylene arm cap	PAUWU-P
upholstered seat, wood back	
upholstered back onlay, upholstered arm cap	PAUWU-U

COUNTER CHAIR:

DESCRIPTION	CODE
upholstered seat, wood back	PCUW
wood seat, wood back	PCWW
upholstered seat, wood back, upholstered back onlay	PCUWU

BAR CHAIR:

DESCRIPTION	CODE
upholstered seat, wood back	PBUW
wood seat, wood back	PBWW
upholstered seat, wood seat, upholstered back onlay	PBUWU

MOBILE STACKING SIDE CHAIR:

DESCRIPTION	CODE
upholstered seat, wood back	PMSSUW
wood seat, wood back	PMSSWW
upholstered seat, wood back, upholstered back onlay	PMSSUWU

MOBILE SIDE CHAIR (NON-STACKING):

DESCRIPTION	CODE
upholstered seat, wood back	PMSUW
wood seat, wood back	PMSWW
upholstered seat, wood back	PMSUWU

MOBILE ARM CHAIR (NON-STACKING):

DESCRIPTION	CODE
upholstered seat, wood back, polypropylene arm cap	PMAUW
wood seat, wood back, polypropylene arm cap	PMAWW
upholstered seat, wood back,	
upholstered back onlay, polypropylene arm cap	PMAUWU-P
upholstered seat, wood back,	
upholstered back onlay, upholstered arm cap	PMAUWU-U

Upholstery Selection

Please refer to Leland Textile Program which features textiles and leathers from the following partners:

- Camira
- Green Hides
- Carnegie
- Maharam
- CF Stinson
- Unika Vaev

The complete grade list can be found on our website or you can specify COM/COL. Due to the design of this product, it is recommended that all non pre-approved textile be tested for compatibility.

Pricing Effective: January 2025

Seat and Back Wood Finish

STANDARD LELAND COLORS

CUSTOM SPECIFY Custom (01)

*Please note that Parfait II is NOT AVAILABLE in the following finishes:
Natural Walnut Matte (08M), Natural Beech (09), Natural White Oak Matte (12M)

Frame Finish

DESCRIPTION	CODE	DESCRIPTION	CODE
Sterling	ST	Matte Mercury	MMR
Warm Grey	WG	Matte Mineral	MMN
Cool Grey	CG	Matte Burnish	MBN
Black	B	Matte Foundry	MFN
White	W	Matte Forest	MFO
Matte Blue Sky	MBS	Matte Willow	MWL
Matte Sienna	MSN		

TEXTURED	CODE	TEXTURED	CODE
Dolphin Textured	DLT	Oxford Textured	OXT
Black Textured	BT	White Textured	WT

Arm Cap Type

DESCRIPTION	CODE
Polypropylene	P
Upholstered	U

Arm Cap Color (Polypropylene)

DESCRIPTION	CODE
Black	B
Silver	S

Glide Type or Caster Type for Mobile Chairs

STANDARD:

DESCRIPTION	CODE
Nylon	S

OPTIONAL:

DESCRIPTION	CODE
Felt	FC
Floor Saver™ (for VCT type floors)	FS
Metal	M
Rubber	R

Please note that optional glides raise the chair height .5 inch.

CASTER TYPE:

DESCRIPTION	CODE
Hard floor caster	HF
Soft floor caster	SF

Specifications required to create the product code

- Model
- Seat Upholstery or Finish
- Back Finish
- Upholstered Back Onlay (when applicable)
- Frame Finish
- Arm Cap Type (when applicable)
- Arm Cap Color or Upholstery (when applicable)
- Glide or Caster Type



MODEL

Parfait II Side Chair -
wood seat, wood back (PSWW)

SEAT UPHOLSTERY OR FINISH

Natural (11)

BACK FINISH

Natural (11)

UPHOLSTERED BACK ONLAY

When applicable, enter upholstery grade, COM or COL



FRAME FINISH

Sterling (ST)

ARM CAP TYPE

When applicable, enter arm cap type code

ARM CAP COLOR OR UPHOLSTERY

When applicable, enter color, upholstery grade, COM or COL



PARFAIT II STACKING SIDE CHAIR

Design: Bruce Sienkowski

PII5



Parfait II

Stacking Side Chair

	MODEL	LIST PRICE/GRADE	COM/COL	A	B	C	D	E	F	G	H	I	J	K	L
Upholstered seat, wood back	PSSUW		\$707	738	755	772	789	806	823	840	857	874	891	908	925

W 20.25 D 21.5 H 32.5 SH 19

Optional Glides: Add \$8.00 net per chair for a set of four (4). Optional Glides raise chair height .5 inch.

COM Yardage: 1 or 2 seats: .75 yard; 3 or 4 seats: 1.5 yards; 5 or 6 seats: 2.25 yards

Contact Leland Customer Experience for yardage requirements on textiles with repeats.

For COL requirements please contact Leland Customer Experience.



Parfait II

Stacking Side Chair

	MODEL	LIST PRICE
Wood seat, wood back	PSSWW	\$739

W 20.25 D 21.5 H 32.5 SH 18.5

Optional Glides: Add \$8.00 net per chair for a set of four (4). Optional Glides raise chair height .5 inch.



Parfait II

Stacking Side Chair

	MODEL	LIST PRICE/GRADE	COM/COL	A	B	C	D	E	F	G	H	I	J	K	L
Upholstered seat and back	PSSUWU		\$796	844	869	894	919	944	969	994	1019	1044	1069	1094	1119

W 20.25 D 21.5 H 32.5 SH 19

Optional Glides: Add \$8.00 net per chair for a set of four (4). Optional Glides raise chair height .5 inch.

COM Yardage: 1 seat and back: .75 yard; 6 seats and backs: 3.5 yards

Contact Leland Customer Experience for yardage requirements on textiles with repeats.

Optional Glides: Add \$8.00 net per chair for a set of four (4).

To specify:

Please refer to pages 3-5 for complete specifying information.

Specify all products by their product code.

Pricing Effective: January 2025

PARFAIT II NON-STACKING SIDE CHAIR

Design: Bruce Sienkowski

PII6



Parfait II

Non-Stacking Side Chair

	MODEL	LIST PRICE/GRADE	COM/COL	A	B	C	D	E	F	G	H	I	J	K	L
Upholstered seat, wood back	PSUW		\$637	669	687	705	723	741	759	777	795	813	831	849	867

W 20.25 D 21.5 H 32.5 SH 19

Optional Glides: Add \$8.00 net per chair for a set of four (4). Optional Glides raise chair height .5 inch.

COM Yardage: 1 or 2 seats: .75 yard; 3 or 4 seats: 1.5 yards; 5 or 6 seats: 2.25 yards



Parfait II

Non-Stacking Side Chair

	MODEL	LIST PRICE
Wood seat, wood back	PSWW	\$673

W 20.25 D 21.5 H 32.5 SH 18.5

Optional Glides: Add \$8.00 net per chair for a set of four (4). Optional Glides raise chair height .5 inch.



Parfait II

Non-Stacking Side Chair

	MODEL	LIST PRICE/GRADE	COM/COL	A	B	C	D	E	F	G	H	I	J	K	L
Upholstered seat and back	PSUWU		\$748	796	821	846	871	896	921	946	971	996	1021	1046	1071

W 20.25 D 21.5 H 32.5 SH 19

Optional Glides: Add \$8.00 net per chair for a set of four (4). Optional Glides raise chair height .5 inch.

COM Yardage: 1 seat and back: .75 yard; 6 seats and backs: 3.5 yards

Contact Leland Customer Experience for yardage requirements on textiles with repeats.

Optional Glides: Add \$8.00 net per chair for a set of four (4).

To specify:

Please refer to pages 3-5 for complete specifying information.

Specify all products by their product code.

Pricing Effective: January 2025

PARFAIT II MOBILE STACKING SIDE CHAIR
 Design: Bruce Sienkowski

PII7

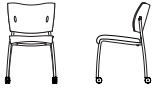

**Parfait II Mobile
 Stacking Side Chair**

	MODEL	LIST PRICE/GRADE	COM/COL	A	B	C	D	E	F	G	H	I	J	K	L
Upholstered seat, wood back Hard floor caster	PMSSUW-HF	\$707		738	755	772	789	806	823	840	857	874	891	908	925
COM Yardage: 1 or 2 seats: .75 yard; 3 or 4 seats: 1.5 yards; 5 or 6 seats: 2.25 yards															
Contact Leland Customer Experience for yardage requirements on textiles with repeats.															
For COL requirements please contact Leland Customer Experience.															
W 20.25	D 21.5	H 32.5	SH 19												

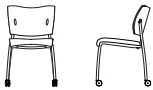

**Parfait II Mobile
 Stacking Side Chair**

	MODEL	LIST PRICE/GRADE	COM/COL	A	B	C	D	E	F	G	H	I	J	K	L
Upholstered seat, wood back Soft floor caster	PMSSUW-SF	\$707		738	755	772	789	806	823	840	857	874	891	908	925
COM Yardage: 1 or 2 seats: .75 yard; 3 or 4 seats: 1.5 yards; 5 or 6 seats: 2.25 yards															
Contact Leland Customer Experience for yardage requirements on textiles with repeats.															
For COL requirements please contact Leland Customer Experience.															
W 20.25	D 21.5	H 32.5	SH 19												

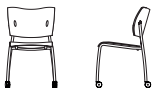

**Parfait II Mobile
 Stacking Side Chair**

	MODEL	LIST PRICE	
Wood seat, wood back Hard floor cast	PMSSWW-HF	\$893	
W 20.25	D 21.5	H 32.5	SH 18.5



**Parfait II Mobile
 Stacking Side Chair**

	MODEL	LIST PRICE	
Wood seat, wood back Soft floor cast	PMSSWW-SF	\$893	
W 20.25	D 21.5	H 32.5	SH 18.5

To specify:
 Please refer to pages 3-5 for complete specifying information.
 Specify all products by their product code.

Pricing Effective: January 2025

PARFAIT II MOBILE STACKING SIDE CHAIR

Design: Bruce Sienkowski

PII8

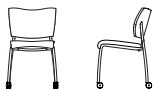

Parfait II Mobile Stacking Side Chair

MODEL	LIST PRICE/GRADE	COM/COL	A	B	C	D	E	F	G	H	I	J	K	L
PMSSUWU-HF		\$941	989	1014	1039	1064	1089	1114	1139	1164	1189	1214	1239	1264

Upholstered seat, wood back,
Upholstered back onlay,
Hard floor caster

COM Yardage: 1-2 chair seats and back onlays: .75 yard; 3-4 chair seats and back onlays: 1.5 yards; 5-6 chair seats and back onlays: 2.25 yards

Contact Leland Customer Experience for yardage requirements on textiles with repeats.

Optional Glides: Add \$8.00 net per chair for a set of four (4).

W 20.25 D 21.5 H 32.5 SH 19

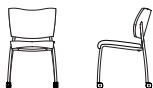

Parfait II Mobile Stacking Side Chair

MODEL	LIST PRICE/GRADE	COM/COL	A	B	C	D	E	F	G	H	I	J	K	L
PMSSUWU-SF		\$941	989	1014	1039	1064	1089	1114	1139	1164	1189	1214	1239	1264

Upholstered seat, wood back,
Upholstered back onlay,
Soft floor caster

COM Yardage: 1-2 chair seats and back onlays: .75 yard; 3-4 chair seats and back onlays: 1.5 yards; 5-6 chair seats and back onlays: 2.25 yards

Contact Leland Customer Experience for yardage requirements on textiles with repeats.

Optional Glides: Add \$8.00 net per chair for a set of four (4).

W 20.25 D 21.5 H 32.5 SH 19

To specify:

Please refer to pages 3-5 for complete specifying information.

Specify all products by their product code.

Pricing Effective: January 2025

PARFAIT II MOBILE NON-STACKING SIDE CHAIR

Design: Bruce Sienkowski

PII9

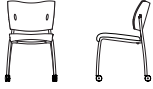

Parfait II Mobile

Non-Stacking Side Chair

	MODEL	LIST PRICE/GRADE	COM/COL	A	B	C	D	E	F	G	H	I	J	K	L
Upholstered seat, wood back, Hard floor caster	PMSUW-HF	\$778		809	826	843	860	877	894	911	928	945	962	979	996
W 20.25 D 21.5 H 32.5 SH 19															
COM Yardage: 1 or 2 seats: .75 yard; 3 or 4 seats: 1.5 yards; 5 or 6 seats: 2.25 yards															
Contact Leland Customer Experience for yardage requirements on textiles with repeats.															
For COL requirements please contact Leland Customer Experience.															

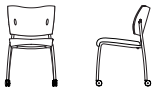

Parfait II Mobile

Non-Stacking Side Chair

	MODEL	LIST PRICE/GRADE	COM/COL	A	B	C	D	E	F	G	H	I	J	K	L
Upholstered seat, wood back, Soft floor caster	PMSUW-SF	\$778		809	826	843	860	877	894	911	928	945	962	979	996
W 20.25 D 21.5 H 32.5 SH 19															
COM Yardage: 1 or 2 seats: .75 yard; 3 or 4 seats: 1.5 yards; 5 or 6 seats: 2.25 yards															
Contact Leland Customer Experience for yardage requirements on textiles with repeats.															
For COL requirements please contact Leland Customer Experience.															

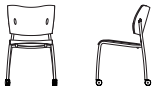

Parfait II

Non-Stacking Side Chair

	MODEL	LIST PRICE
Wood seat, wood back, Hard floor caster	PMSWW-HF	\$820
W 20.25 D 21.5 H 32.5 SH 18.5		



Parfait II

Non-Stacking Side Chair

	MODEL	LIST PRICE
Wood seat, wood back, Soft floor caster	PMSWW-SF	\$820
W 20.25 D 21.5 H 32.5 SH 18.5		

To specify:

Please refer to pages 3-5 for complete specifying information. Specify all products by their product code.

Pricing Effective: January 2025

PARFAIT II MOBILE NON-STACKING SIDE CHAIR

Design: Bruce Sienkowski

PII10

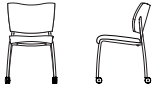

Parfait II
Non-Stacking Side Chair

MODEL	LIST PRICE/GRADE	COM/COL	A	B	C	D	E	F	G	H	I	J	K	L
PMSUWU-HF	\$893		942	967	992	1017	1042	1067	1092	1117	1142	1167	1192	1217

Upholstered seat , wood back,
Upholstered back onlay,
Hard floor caster

COM Yardage: 1-2 chair seats and back onlays: .75 yard; 3-4 chair seats and back onlays: 1.5 yards; 5-6 chair seats and back onlays: 2.25 yards

Contact Leland Customer Experience for yardage requirements on textiles with repeats.

For COL requirements please contact Leland Customer Experience.

W 20.25 D 21.5 H 32.5 SH 19

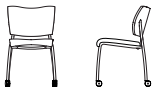

Parfait II
Non-Stacking Side Chair

MODEL	LIST PRICE/GRADE	COM/COL	A	B	C	D	E	F	G	H	I	J	K	L
PMSUWU-SF	\$893		942	967	992	1017	1042	1067	1092	1117	1142	1167	1192	1217

Upholstered seat , wood back,
Upholstered back onlay,
Soft floor caster

COM Yardage: 1-2 chair seats and back onlays: .75 yard; 3-4 chair seats and back onlays: 1.5 yards; 5-6 chair seats and back onlays: 2.25 yards

Contact Leland Customer Experience for yardage requirements on textiles with repeats.

For COL requirements please contact Leland Customer Experience.

W 20.25 D 21.5 H 32.5 SH 19

To specify:
Please refer to pages 3-5 for complete specifying information.
Specify all products by their product code.

Pricing Effective: January 2025

PARFAIT II ARM CHAIR
Design: Bruce Sienkowski

PII11



Parfait II Arm Chair			MODEL	LIST PRICE/GRADE	COM/COL	A	B	C	D	E	F	G	H	I	J	K	L
Upholstered seat, wood back			PAUW	\$921		952	971	990	1009	1028	1047	1066	1085	1104	1123	1142	1161
W 25.25	D 21.5	H 32.5	Optional Glides: Add \$8.00 net per chair for a set of four (4). Optional Glides raise chair height .5 inch.														
SH 19	AH 27	COM Yardage: 1 or 2 seats: .75 yard; 3 or 4 seats: 1.5 yards; 5 or 6 seats: 2.25 yards															
Contact Leland Customer Experience for yardage requirements on textiles with repeats.																	
For COL requirements please contact Leland Customer Experience.																	



Parfait II Arm Chair			MODEL	LIST PRICE
Wood seat, wood back			PAWW	\$953
W 25.25	D 21.5	H 32.5	Optional Glides: Add \$8.00 net per chair for a set of four (4). Optional Glides raise chair height .5 inch.	
SH 18.5	AH 18.5			



Parfait II Arm Chair			MODEL	LIST PRICE/GRADE	COM/COL	A	B	C	D	E	F	G	H	I	J	K	L
Upholstered seat, wood back, Upholstered back onlay, Polypropylene arm cap			PAUWU-P	\$989		1042	1067	1092	1117	1142	1167	1192	1217	1242	1267	1292	1317
W 25.25	D 21.5	H 32.5	Optional Glides: Add \$8.00 net per chair for a set of four (4). Optional Glides raise chair height .5 inch.														
SH 19	AH 27	COM Yardage: 1-2 chair seats and back onlays: .75 yard; 3-4 chair seats and back onlays: 1.5 yards; 5-6 chair seats and back onlays: 2.25 yards															
Contact Leland Customer Experience for yardage requirements on textiles with repeats.																	
For COL requirements please contact Leland Customer Experience.																	



Parfait II Arm Chair			MODEL	LIST PRICE/GRADE	COM/COL	A	B	C	D	E	F	G	H	I	J	K	L
Upholstered seat, wood back, Upholstered back onlay, Upholstered arm cap			PAUWU-U	\$1044		1093	1118	1143	1168	1193	1218	1243	1268	1293	1318	1343	1368
W 25.25	D 21.5	H 32.5	Optional Glides: Add \$8.00 net per chair for a set of four (4). Optional Glides raise chair height .5 inch.														
SH 19	AH 27	COM Yardage: 1-2 chair seats and back onlays: .75 yard; 3-4 chair seats and back onlays: 1.5 yards; 5-6 chair seats and back onlays: 2.25 yards															
1 or 2 pairs arm caps: .25 yard																	
Contact Leland Customer Experience for yardage requirements on textiles with repeats.																	
For COL requirements please contact Leland Customer Experience.																	

To specify:
Please refer to pages 3-5 for complete specifying information.
Specify all products by their product code.

Pricing Effective: January 2025

PARFAIT II MOBILE ARM CHAIR
 Design: Bruce Sienkowski

PII12



Parfait II Mobile Arm Chair	MODEL	LIST PRICE/GRADE	COM/COL	A	B	C	D	E	F	G	H	I	J	K	L
Upholstered seat, wood back, Polypropylene arm cap, Hard floor caster	PMAUW-P-HF	\$1085		1117	1135	1153	1171	1189	1207	1225	1243	1261	1279	1297	1315
W 25.5 D 21.5 H 32.5 SH 19 AH 27															
		COM Yardage: 1 or 2 seats: .75 yard; 3 or 4 seats: 1.5 yards; 5 or 6 seats: 2.25 yards Contact Leland Customer Experience for yardage requirements on textiles with repeats. For COL requirements please contact Leland Customer Experience.													

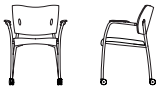

Parfait II Mobile Arm Chair	MODEL	LIST PRICE/GRADE	COM/COL	A	B	C	D	E	F	G	H	I	J	K	L
Upholstered seat, wood back, Polypropylene arm cap, Soft floor caster	PMAUW-P-SF	\$1085		1117	1135	1153	1171	1189	1207	1225	1243	1261	1279	1297	1315
W 25.5 D 21.5 H 32.5 SH 19 AH 27															
		COM Yardage: 1 or 2 seats: .75 yard; 3 or 4 seats: 1.5 yards; 5 or 6 seats: 2.25 yards Contact Leland Customer Experience for yardage requirements on textiles with repeats. For COL requirements please contact Leland Customer Experience.													



Parfait II Mobile Arm Chair	MODEL	LIST PRICE
Wood seat, wood back, Polypropylene arm cap, Hard floor caster	PMAWW-P-HF	\$1129
W 25.5 D 21.5 H 32.5 SH 18.5		



Parfait II Mobile Arm Chair	MODEL	LIST PRICE
Wood seat, wood back, Polypropylene arm cap, Soft floor caster	PMAWW-P-SF	\$1129
W 25.5 D 21.5 H 32.5 SH 18.5		

To specify:
 Please refer to pages 3-5 for complete specifying information.
 Specify all products by their product code.

PARFAIT II MOBILE ARM CHAIR

Design: Bruce Sienkowski

PII13



Parfait II Mobile

Arm Chair

	MODEL	LIST PRICE/GRADE	COM/COL	A	B	C	D	E	F	G	H	I	J	K	L
Upholstered seat, Upholstered back onlay, Upholstered arm cap, Hard floor caster	PMAUWU-U-HF		\$1205	1254	1280	1306	1332	1358	1384	1410	1436	1462	1488	1514	1540
W 25.5 D 21.5 H 32.5															
SH 19 AH 27															

COM Yardage: 1 or 2 seats: .75 yard; 3 or 4 seats: 1.5 yards; 5 or 6 seats: 2.25 yards
2 pairs armcaps: .25 yard
Contact Leland Customer Experience for yardage requirements on textiles with repeats.
For COL requirements please contact Leland Customer Experience.



Parfait II Mobile

Arm Chair

	MODEL	LIST PRICE/GRADE	COM/COL	A	B	C	D	E	F	G	H	I	J	K	L
Upholstered seat, Upholstered back onlay, Upholstered arm cap, Soft floor caster	PMAUWU-U-SF		\$1205	1254	1280	1306	1332	1358	1384	1410	1436	1462	1488	1514	1540
W 25.5 D 21.5 H 32.5															
SH 19 AH 27															

COM Yardage: 1 or 2 seats: .75 yard; 3 or 4 seats: 1.5 yards; 5 or 6 seats: 2.25 yards
2 pairs armcaps: .25 yard
Contact Leland Customer Experience for yardage requirements on textiles with repeats.
For COL requirements please contact Leland Customer Experience.



Parfait II Mobile

Arm Chair

	MODEL	LIST PRICE/GRADE	COM/COL	A	B	C	D	E	F	G	H	I	J	K	L
Upholstered seat, Upholstered back onlay, Polypropylene arm cap, Hard floor caster	PMAUWU-P-HF		\$1151	1201	1227	1253	1279	1305	1331	1357	1383	1409	1435	1461	1487
W 25.5 D 21.5 H 32.5															
SH 19 AH 27															

COM Yardage: 1 or 2 seats: .75 yard; 3 or 4 seats: 1.5 yards; 5 or 6 seats: 2.25 yards
2 pairs armcaps: .25 yard
Contact Leland Customer Experience for yardage requirements on textiles with repeats.
For COL requirements please contact Leland Customer Experience.



Parfait II Mobile

Arm Chair

	MODEL	LIST PRICE/GRADE	COM/COL	A	B	C	D	E	F	G	H	I	J	K	L
Upholstered seat, Upholstered back onlay, Polypropylene arm cap, Soft floor caster	PMAUWU-P-SF		\$1151	1201	1227	1253	1279	1305	1331	1357	1383	1409	1435	1461	1487
W 25.5 D 21.5 H 32.5															
SH 19 AH 27															

COM Yardage: 1 or 2 seats: .75 yard; 3 or 4 seats: 1.5 yards; 5 or 6 seats: 2.25 yards
2 pairs armcaps: .25 yard
Contact Leland Customer Experience for yardage requirements on textiles with repeats.
For COL requirements please contact Leland Customer Experience.

To specify:

Please refer to pages 3-5 for complete specifying information.

Specify all products by their product code.

Pricing Effective: January 2025

PARFAIT II COUNTER CHAIR
 Design: Bruce Sienkowski

PII14

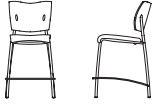

Parfait II Counter Chair	MODEL	LIST PRICE/GRADE	COM/COL	A	B	C	D	E	F	G	H	I	J	K	L
Upholstered seat, Wood back	PCUW		\$913	945	963	981	999	1017	1035	1053	1071	1089	1107	1125	1143
Optional Glides: Add \$8.00 net per chair for a set of four (4). Optional Glides raise chair height .5 inch.															
COM Yardage: 1 or 2 seats: .75 yard; 3 or 4 seats: 1.5 yards; 5 or 6 seats: 2.25 yards															
W 19.5 D 24 H 39 SH 25.5	Contact Leland Customer Experience for yardage requirements on textiles with repeats.														
For COL requirements please contact Leland Customer Experience.															



Parfait II Counter Chair	MODEL	LIST PRICE
Wood seat, wood back	PCWW	\$953
W 19.5 D 24 H 39 SH 25	Optional Glides: Add \$8.00 net per chair for a set of four (4). Optional Glides raise chair height .5 inch.	



Parfait II Counter Chair	MODEL	LIST PRICE/GRADE	COM/COL	A	B	C	D	E	F	G	H	I	J	K	L
Upholstered seat, Wood back, Upholstered back onlay	PCUWU		\$984	1034	1061	1088	1115	1142	1169	1196	1223	1250	1277	1304	1331
Optional Glides: Add \$8.00 net per chair for a set of four (4). Optional Glides raise chair height .5 inch.															
COM Yardage: 1 seat and back: .75 yard; 6 seats and backs: 3.5 yards															
W 19.5 D 24 H 39 SH 25.5	Contact Leland Customer Experience for yardage requirements on textiles with repeats.														
Optional Glides: Add \$8.00 net per chair for a set of four (4).															

To specify:
 Please refer to pages 3-5 for complete specifying information.
 Specify all products by their product code.

PARFAIT II BAR CHAIR
Design: Bruce Sienkowski

PII15



Parfait II Bar Chair	MODEL	LIST PRICE/GRADE	COM/COL	A	B	C	D	E	F	G	H	I	J	K	L
Upholstered seat, Wood back	PBUW		\$929	961	979	997	1015	1033	1051	1069	1087	1105	1123	1141	1159
Optional Glides: Add \$8.00 net per chair for a set of four (4). Optional Glides raise chair height .5 inch.															
COM Yardage: 1 or 2 seats: .75 yard; 3 or 4 seats: 1.5 yards; 5 or 6 seats: 2.25 yards															
Contact Leland Customer Experience for yardage requirements on textiles with repeats.															
For COL requirements please contact Leland Customer Experience.															
W 19.5	D 24	H 44	SH 31.5												

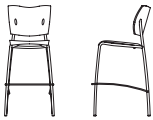

Parfait II Bar Chair	MODEL	LIST PRICE													
Wood seat, wood back	PBWW	\$972													
Optional Glides: Add \$8.00 net per chair for a set of four (4). Optional Glides raise chair height .5 inch.															
W 19.5	D 24.5	H 44	SH 31												

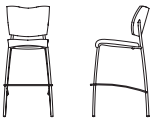

Parfait II Bar Chair	MODEL	LIST PRICE/GRADE	COM/COL	A	B	C	D	E	F	G	H	I	J	K	L
Upholstered seat, Wood back, Upholstered back onlay	PBUWU		\$998	1047	1073	1099	1125	1151	1177	1203	1229	1255	1281	1307	1333
Optional Glides: Add \$8.00 net per chair for a set of four (4). Optional Glides raise chair height .5 inch.															
COM Yardage: 1 seat and back: .75 yard; 6 seats and backs: 3.5 yards															
Contact Leland Customer Experience for yardage requirements on textiles with repeats.															
Optional Glides: Add \$8.00 net per chair for a set of four (4).															
W 19.5	D 24	H 44	SH 31.5												

To specify:
Please refer to pages 3-5 for complete specifying information.
Specify all products by their product code.

Pricing Effective: January 2025

PARFAIT II TRANSPORT/STACKING DOLLY
 Design: Bruce Sienkowski

PII16

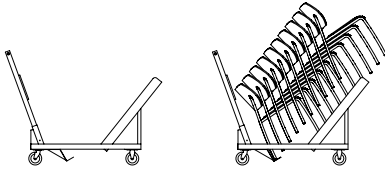

**Parfait II Transport/
 Stacking Dolly**

			MODEL	LIST PRICE
			PSSD	Black Finish
				\$1121

W 25 D 57 H 44 (empty)

Parfait II Transport/Stacking Dolly handles up to 10 Parfait II stacking side chairs.

Please note that only the stacking version of the side chair will stack on the floor or Transport/Stacking Dolly.

With 10 stacking chairs:

W 25 D 68 H 63

To specify:
 Please refer to pages 3-5 for
 complete specifying information.
 Specify all products by their
 product code.

Pricing Effective: January 2025

5695 Eagle Drive, SE
Grand Rapids,
Michigan 49512
616-975-9260
lelandfurniture.com

Pluto

January 2025 Price List



Pluto

Table of Contents	PB2
Specification Information	PB3
Specification Example	PB4
Bench	PB5
Auxiliary Option	PB6

Bench Model

DESCRIPTION	CODE
Pluto	PT

Upholstery Selection

Please refer to Leland Textile Program which features textiles from the following partners:

- Camira
- Carnegie
- CF Stinson
- Green Hides
- Maharam
- Unika Vaev

The complete grade list can be found on our website or you can specify COM/COL. Due to the design of this product, it is recommended that all non pre-approved textile be tested for compatibility.

Upholstery Requirements

With a choice of textile combinations, Pluto encourages design creativity. Please note that requirements vary by combination. The graded price of the combined yardage will be calculated using the highest grade textile selected.

TEXTILE REQUIREMENTS	YARDAGE
One textile, entire bench:	3.25 yards
Two/Three textile combination	
Seat:	1 yard
Top:	1 yard
Side:	1.25 yards

Plinth Finish: Powdercoat and Chrome

DESCRIPTION	CODE
Sterling	ST
Warm Grey	WG
Cool Grey	CG
Black	B
White	W
Matte Mercury	MMR
Matte Mineral	MMN
Matte Burnish	MBN
Matte Foundry	MFN
Brushed Chrome	BC

Auxiliary Options

Floor mount must be specified at the time of the bench order.

DESCRIPTION	CODE
Floor mount	PTFM

Glides

Pluto glides are poly.

Shipment Detail

200 pounds of weight ballast is shipped separately from the Pluto bench and is required to be installed at the final delivery location.

Specifications required to create the product code

- Model
- Seat Upholstery
- Top Upholstery
- Side Upholstery
- Plinth Finish
- Floor Mount (when applicable)

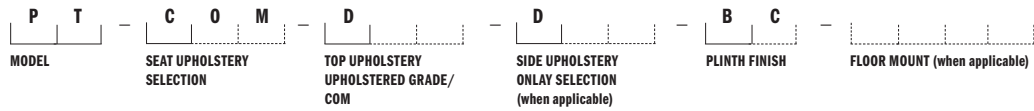

MODEL

Pluto (PT)

SEAT UPHOLSTERY

COM (COM)

TOP UPHOLSTERY

Grade D (D)

SIDE UPHOLSTERY

Grade D (D)

PLINTH FINISH

Brushed Chrome (BC)

FLOOR MOUNT

When applicable, enter Pluto Floor Mount Code



PLUTO BENCH
Design: Simon Pengelly

PB5

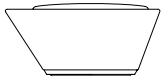

Pluto Bench	MODEL	LIST PRICE/GRADE	COM/COL	A	B	C	D	E	F	G	H	I	J	K	L
--------------------	--------------	-------------------------	----------------	----------	----------	----------	----------	----------	----------	----------	----------	----------	----------	----------	----------

Powder coat plinth	PT-PC	Powder Coat	\$1804	2038	2156	2274	2392	2510	2628	2746	2864	2982	3100	3218	3336
--------------------	-------	-------------	--------	------	------	------	------	------	------	------	------	------	------	------	------

COM REQUIREMENTS VARY BY COMBINATION SELECTED.

W 34 D 37.75 H 16

TEXTILE REQUIREMENTS:

YARDAGE

One textile, entire bench:

3.25 yards

Two/Three textile combination

Seat: 1 yard

Top: 1 yard

Side: 1.25 yards

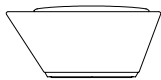

Pluto Bench	MODEL	LIST PRICE/GRADE	COM/COL	A	B	C	D	E	F	G	H	I	J	K	L
--------------------	--------------	-------------------------	----------------	----------	----------	----------	----------	----------	----------	----------	----------	----------	----------	----------	----------

Brushed chrome plinth	PT-BC	Powder Coat	\$1988	2221	2340	2459	2578	2697	2816	2935	3054	3173	3292	3411	3530
-----------------------	-------	-------------	--------	------	------	------	------	------	------	------	------	------	------	------	------

COM REQUIREMENTS VARY BY COMBINATION SELECTED.

W 34 D 37.75 H 16

TEXTILE REQUIREMENTS:

YARDAGE

One textile, entire bench:

3.25 yards

Two/Three textile combination

Seat: 1 yard

Top: 1 yard

Side: 1.25 yards

To specify:

Please refer to pages 3-4 for complete specifying information. Specify all products by their product code.

Pricing Effective: January 2025

PLUTO BENCH AUXILIARY OPTION

Design: Simon Pengelly

PB6

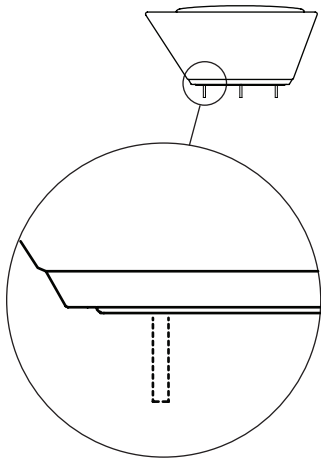

Pluto Floor Mount

MODEL	LIST PRICE/GRADE	LIST PRICE
PTFM	Powder Coat	\$185

Due to the variety of floor surfaces on which the Pluto Bench may be installed, floor mount fasteners are not supplied by Leland International. The Pluto Bench floor mount feature consists of three .5" thru holes designed to use .3125" or .375" threaded studs. Leland International recommends at least 2" of exposed thread length from the floor surface.

Responsibility of fastener choice is the customers.

Floor Mount must be specified at the time of purchasing.

The Floor Mount cannot be added later in the field.

To specify:

Please refer to pages 3-4 for complete specifying information.

Specify all products by their product code.

Pricing Effective: January 2025

5695 Eagle Drive, SE
Grand Rapids,
Michigan 49512
616-975-9260
lelandfurniture.com

Quarry

January 2025 Price List



Quarry

Table of Contents	QR2
Bench Specification Information	QR3
Bench Specification Example	QR4
Benches	QR5
Collaborative Work Tools Specification Information	QR6
Collaborative Work Tools Specification Example	QR7
Collaborative Work Tools	QR8
Quarry Groupings	QR9

Bench Model

DESCRIPTION	CODE
Flint	QF
Mica	QM
Shale	QS
Quartz	QQ

Upholstery Selection

Please refer to Leland Textile Program which features textiles and leathers from the following partners:

- Camira
- Carnegie
- CF Stinson
- Green Hides
- Maharam
- Unika Vaev

The complete grade list can be found at www.lelandfurniture.com/ecatalog or you can specify COM/COL. Due to the design of this product, it is recommended that all non pre-approved textile be tested for compatibility.

Stitching Detail

DESCRIPTION	CODE
Basic (Recommended for patterned textiles)	B
Premium (Standard stitch on Quarry Benches)	P

Glide Selection

STANDARD GLIDES:

DESCRIPTION	CODE
Poly	P

OPTIONAL GLIDES:

DESCRIPTION	CODE
Felt	F

Auxiliary Options

DESCRIPTION	CODE
Weight Ballast (50 lbs.)	WB

Plinth Finish

All plinths are stainless steel.

Specifications required to create the product code

- Model
- Upholstery Selection
- Stitching Detail
- Glide Selection
- Auxiliary Option (when applicable)



MODEL

Quarry Flint (QF)

UPHOLSTERY SELECTION

Enter upholstery grade or COM.
Grade D (D)

STITCHING DETAIL

Premium (P)

GLIDE SELECTION

Poly (P)

AUXILIARY OPTION

When applicable



QUARRY BENCHES
Design: Bruce Sienkowski

QR5



Flint			MODEL	LIST PRICE/GRADE	COM/COL	A	B	C	D	E	F	G	H	I	J	K	L
W 19	D 18	H 19	QF	\$1388		1506	1565	1624	1683	1742	1801	1860	1919	1978	2037	2096	2155

Optional Glides: Add \$8.00 net per chair for a set of four (4). Optional Glides raise bench height .5 inch.
 Contrasting Stitch: Add \$25 net per bench - specify black (-CSB) or white thread (-CSW)
 COM Yardage: 1.25 yards
 Contact Leland Customer Experience for yardage requirements on textiles with repeats.



Mica			MODEL	LIST PRICE/GRADE	COM/COL	A	B	C	D	E	F	G	H	I	J	K	L
W 19	D 20	H 19	QM	\$1388		1506	1565	1624	1683	1742	1801	1860	1919	1978	2037	2096	2155

Optional Glides: Add \$8.00 net per chair for a set of four (4). Optional Glides raise bench height .5 inch.
 Contrasting Stitch: Add \$25 net per bench - specify black (-CSB) or white thread (-CSW)
 COM Yardage: 1.25 yards
 Contact Leland Customer Experience for yardage requirements on textiles with repeats.

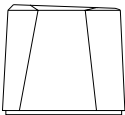

Shale			MODEL	LIST PRICE/GRADE	COM/COL	A	B	C	D	E	F	G	H	I	J	K	L
W 22	D 28.5	H 25.25	QS	\$1525		1689	1770	1851	1932	2013	2094	2175	2256	2337	2418	2499	2580

Optional Glides: Add \$8.00 net per chair for a set of four (4). Optional Glides raise bench height .5 inch.
 Contrasting Stitch: Add \$25 net per bench - specify black (-CSB) or white thread (-CSW)
 COM Yardage: 2.25 yards
 Contact Leland Customer Experience for yardage requirements on textiles with repeats.

Quartz			MODEL	LIST PRICE/GRADE	COM/COL	A	B	C	D	E	F	G	H	I	J	K	L
W 28.5	D 26	H 16.5	QQ	\$1525		1639	1696	1753	1810	1867	1924	1981	2038	2095	2152	2209	2266

Optional Glides: Add \$8.00 net per chair for a set of four (4). Optional Glides raise bench height .5 inch.
 Contrasting Stitch: Add \$25 net per bench - specify black (-CSB) or white thread (-CSW)
 COM Yardage: 1.75 yards
 Contact Leland Customer Experience for yardage requirements on textiles with repeats.

Weight Ballast		MODEL	LIST PRICE
50 lbs.		WB	92

To specify:
 Please refer to pages 3-4 for complete specifying information.
 Specify all products by their product code.

Collaborative Work Space Model

DESCRIPTION	CODE
Flint bench with tablet	QFT
Mobile tablet stand	QMT
Power module	QPM

Tablet Support or Mobile Tablet Column Finish

DESCRIPTION	CODE
White	W
Sterling	ST
Black	B

Upholstery Selection

Please refer to Leland Textile Program which features textiles and leathers from the following partners:

- Camira
- Green Hides
- Carnegie
- Maharam
- CF Stinson
- Unika Vaev

The complete grade list can be found on our website or you can specify COM/COL. Due to the design of this product, it is recommended that all non pre-approved textile be tested for compatibility.

Stitching Detail

DESCRIPTION	CODE
Basic (Recommended for patterned textiles)	B
Premium (Standard stitch on Quarry Benches)	P

Top Surface

DESCRIPTION	CODE
Corian®	C
Wood	V
Laminate	L

Top Surface Finish or Color

CORIAN® TOPS:

DESCRIPTION	CODE
Black Corian®	CB
White Corian®	CW
Grey Corian®	CG

WOOD TOPS:

STANDARD LELAND COLORS

*Natural Finish specify Natural 11

**Custom Finish specify Custom 01

LAMINATE TOPS:

DESCRIPTION	CODE
Platinum Wilsonart® (D315-60)	LGP
Black Pionite® (SE101)	LBK
White Wilsonart® (D354-60)	LWH

Note that Collaborative Work Tool edges are finished to match for wood tops and Natural 11 for laminate tops.

Glide Selection

STANDARD:

DESCRIPTION	CODE
Poly	P

OPTIONAL:

DESCRIPTION	CODE
Felt	F

Power Options

DESCRIPTION	CODE
1 Power Unit, three (3) 120v AC receptacles with 7'6" cord	3P
1 Power Unit, four (4) 120v AC receptacles, one (1) USB simplex charger with 7'6" cord	4P

Freight Note

Due to the size and nature of Quarry Collaborative Work Tools, the Freight Program does not apply to this product. Please contact Customer Experience for a quote.

Specifications required to create the product code

- Model
- Tablet Support or Mobile Tablet Stand Column Finish (when applicable)
- Upholstery Selection (when applicable)
- Stitching Detail (when applicable)
- Top Surface
- Top Surface Finish or Color
- Glide Selection
- Power Options (when applicable)



MODEL

Quarry Mobile Tablet Stand (QMT)

TABLET SUPPORT OR MOBILE STAND COLUMN FINISH

White (W)

UPHOLSTERY SELECTION

When applicable, enter upholstery grade or COM

STITCHING DETAIL

When applicable

TOP SURFACE

Corian® (C)

TOP SURFACE FINISH OR COLOR

Grey Corian® (CG)

GLIDE SELECTION

When applicable

POWER OPTIONS

When applicable



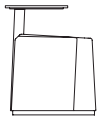

Flint Bench with Tablet				MODEL	LIST PRICE/GRADE	COM/COL	A	B	C	D	E	F	G	H	I	J	K	L
W 25.6	D 21.5	H 25.5	SH 19	QFT	Corian®	\$2735	2856	2919	2982	3045	3108	3171	3234	3297	3360	3423	3486	3549
					Wood	\$2666	2787	2849	2911	2973	3035	3097	3159	3221	3283	3345	3407	3469
					Laminate	\$2598	2720	2782	2844	2906	2968	3030	3092	3154	3216	3278	3340	3402

Optional Glides: Add \$8.00 net per chair for a set of four (4). Optional Glides raise bench height .5 inch.

COM Yardage: 1.75 yards

Contact Leland Customer Experience for yardage requirements on textiles with repeats.

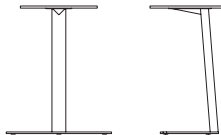

Mobile Tablet Stand			MODEL	FRAME FINISH	LIST PRICE
W 24.7	D 17	H 26	QMT	Corian®	\$1503
				Wood	\$1391
				Laminate	\$1325

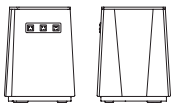

Power Module				MODEL	LIST PRICE/GRADE	COM/COL	A	B	C	D	E	F	G	H	I	J	K	L
W 16.5	D 17.25	H 22.4		QPM-__ P	Corian®	\$2735	2856	2919	2982	3045	3108	3171	3234	3297	3360	3423	3486	3549
					Wood	\$2666	2787	2849	2911	2973	3035	3097	3159	3221	3283	3345	3407	3469
					Laminate	\$2598	2720	2782	2844	2906	2968	3030	3092	3154	3216	3278	3340	3402

Three (3) AC receptables with
 7'6" power cord or four (4) AC receptacles,

One (1) USB simplex charger,
 with 7'6" power cord

Optional Glides: Add \$8.00 net per chair for a set of four (4). Optional Glides raise bench height .5 inch.

One (1) USB simplex charge, COM Yardage: 1.5 yards

With 7'6" oiwer cord. Contact Leland Customer Experience for yardage requirements on textiles with repeats.

To specify:

Please refer to pages 6-7 for complete specifying information.

Specify all products by their product code.

QUARRY BENCH GROUPINGS

Design: Bruce Sienkowski

QR9

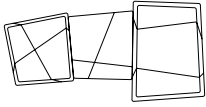

Example A	BENCHES	TOTAL COM LIST PRICE
	Flint (QF)	\$4301
	Mica (QM)	
	Shale (QS)	

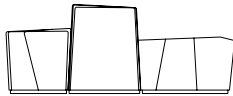
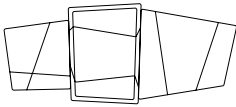

Example B	BENCHES	TOTAL COM LIST PRICE
	Mica (QM)	\$4438
	Shale (QS)	
	Quartz (QQ)	

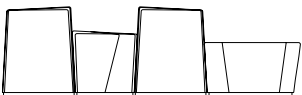
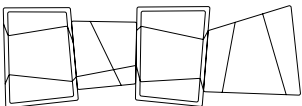

Example C	BENCHES	TOTAL COM LIST PRICE
	Shale (QS)	\$5963
	Mica (QM)	
	Shale (QS)	
	Quartz (QQ)	

Please note that example groups are provided as a specification tool. Example groups are shown from top and side profiles. Quarry benches must be ordered as separate line items for each unique model and/or finish specification.

To specify:

Please refer to pages 3-4 for complete specifying information.

Specify all products by their product code.

Pricing Effective: January 2025

QUARRY BENCH GROUPINGS

Design: Bruce Sienkowski

QR10

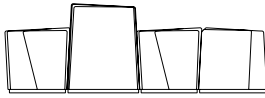
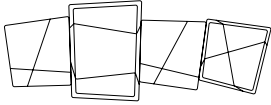

Example D

BENCHES

TOTAL COM LIST PRICE

Mica (QM)

\$5689

Shale (QS)

Mica (QM)

Flint (QF)

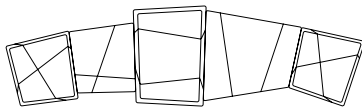

Example E

BENCHES

TOTAL COM LIST PRICE

Flint (QF)

\$7214

Mica (QM)

Shale (QS)

Quartz (QQ)

Flint (QF)

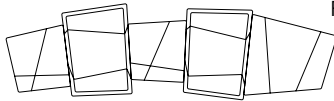

Example F

BENCHES

TOTAL COM LIST PRICE

Mica (QM)

\$7351

Shale (QS)

Mica (QM)

Shale (QS)

Quartz (QQ)

Please note that example groups are provided as a specification tool. Example groups are shown from top and side profiles. Quarry benches must be ordered as separate line items for each unique model and/or finish specification.

To specify:

Please refer to pages 3-4 for complete specifying information.

Specify all products by their product code.

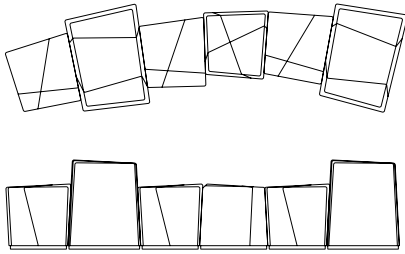

Example G	BENCHES	TOTAL COM LIST PRICE
	Mica (QM)	\$8602
	Shale (QS)	
	Mica (QM)	
	Flint (QF)	
	Mica (QM)	
	Shale (QS)	

Please note that example groups are provided as a specification tool. Example groups are shown from top and side profiles. Quarry benches must be ordered as separate line items for each unique model and/or finish specification.

To specify:
 Please refer to pages 3-4 for complete specifying information.
 Specify all products by their product code.

5695 Eagle Drive, SE
Grand Rapids,
Michigan 49512
616-975-9260
lelandfurniture.com

Rapson Forty-Eight

January 2025 Price List



Rapson Forty-Eight Chair

Table of Contents	RP48-C2
Specification Information	RP48-C3
Specification Example	RP48-C4
Four Leg Steel Frame Side Chair	RP48-C5
Four Leg Maple Frame Side Chair	RP48-C7
Four Leg Steel Frame Counter Chair	RP48-C9
Four Leg Maple Frame Counter Chair	RP48-C11
Four Leg Steel Frame Bar Chair	RP48-C13
Four Leg Maple Frame Bar Chair	RP48-C15

RAPSON FORTY-EIGHT CHAIR SPECIFICATION INFORMATION

RP48-C3

Chair Model

DESCRIPTION	CODE
Rapson Forty-Eight Four Leg Steel Frame Side Chair	RP48-SS
Rapson Forty-Eight Four Leg Maple Frame Side Chair	RP48-MS
Rapson Forty-Eight Four Leg Steel Frame Counter Chair	RP48-SC
Rapson Forty-Eight Four Leg Maple Frame Counter Chair	RP48-MC
Rapson Forty-Eight Four Leg Steel Frame Bar Chair	RP48-SB
Rapson Forty-Eight Four Leg Maple Frame Bar Chair	RP48-MB

Shell Options

DESCRIPTION	CODE
Standard Shell	MP
Standard Shell with Upholstered Seat Pad	MPU
Standard HPL Shell	H
Standard HPL Shell with Upholstered Seat Pad	HU
Fully Upholstered	FU
Walnut Shell	W
Walnut Shell with Upholstered Seat Pad	WU
Premium HPL Shell	P
Premium HPL Shell with Upholstered Seat Pad	PU

Shell Finishes

STANDARD HPL

(HIGH PRESSURE LAMINATE)

DESCRIPTION	CODE
Fiji	FI
Brittany Blue	BB
Moss Grey	MG
Navaho Red	NR
Fresh Papaya	FP
Forsythia	FS
Kool Kiwi	KK
Honey Plantain	HP
Spicy Flavors	SF
Cafe Sienna	CS
Designer White	WL
Platinum	PL

PREMIUM HPL

(HIGH PRESSURE LAMINATE)

DESCRIPTION	CODE
Blueberry Tart	BT
Oxidized Silver	OS
Chili Powder	CP
Marmalade	MM
Copper Alloy	CA

VENEER

STANDARD LELAND COLORS (On maple veneer shell only)

DESCRIPTION	CODE
Walnut	W
Maple	MP

Frame Finish Options

POWDERCOAT

(FOUR LEG STEEL TUBE)

DESCRIPTION	CODE	DESCRIPTION	CODE
Black	B	Cool Grey	CG
Sterling	ST	Matte Burnish	MBN
Warm Grey	WG	Matte Foundry	MFN
White	W	Matte Mineral	MMN
Matte Mercury	MMR	Matte Blue Sky	MBS
Matte Willow	MWL	Matte Forest	MFO
Matte Sienna	MSN	Black Textured	BT
White Textured	WT	Dolphin Textured	DLT

Pricing Effective: January 2025

Frame Finish Options (Cont.)

WOOD

(FOUR LEG WOOD FRAME, ON MAPLE)

DESCRIPTION

LELAND COLORS (Click to view)

Upholstery Option

Please refer to Leland Textile Program which features textiles and leathers from the following partners:

- Camira
- Green Hides
- Carnegie
- Maharam
- CF Stinson
- Unika Vaev

The complete grade list can be found at lelandinternational.com/ecatalog or you can specify COM/COL. Due to the design of this product, it is recommended that all non pre-approved textile be tested for compatibility.

Glide Option

DESCRIPTION	CODE
Nylon (standard)	S
Felt	FC
Floor Saver *only available on metal base	FS
Metal *only available on metal base	M
Rubber *only available on metal base	R

Auxiliary Options

PAINTED GRAPHIC BACK

(VENEER SHELL ONLY)

ART

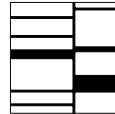

Riff

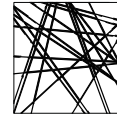

Improv



Bebop

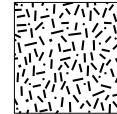

Scat

DESCRIPTION	CODE
Riff	RF
Improv	IM
Bebop	BB
Scat	SC

PAINTED GRAPHIC COLOR OPTIONS

DESCRIPTION	CODE	DESCRIPTION	CODE
Oxford II	49M	Putty	44M
Dolphin II	50M	Oyster	45M

Only available on veneer shells finished in a clear finish (Natural Walnut 08, Natural Walnut 08M, Natural Maple 11, or Natural Maple 11M).

SHELL HANDHOLD

DESCRIPTION	CODE
Handhold	HH

RAPSON FORTY-EIGHT FOUR LEG STEEL FRAME
SIDE CHAIR Design: Ralph Rapson

RP48-C5



**Rapson Forty-Eight
Steel Frame Side Chair**

	MODEL	LIST PRICE
Standard HPL Shell	RP48-SS-H	\$663
W 22 D 22.5 H 31.75 SH 18		Optional Glides: Add \$8.00 net per chair for a set of four (4).



**Rapson Forty-Eight
Steel Frame Side Chair**

	MODEL	COM/COL	A	B	C	D	E	F	G	H	I	J	K	L
Standard HPL Shell, upholstered seat pad	RP48-SS-HU	\$742	789	814	839	864	889	914	939	964	989	1014	1039	1064



**Rapson Forty-Eight
Steel Frame Side Chair**

	MODEL	COM/COL	A	B	C	D	E	F	G	H	I	J	K	L
Fully Upholstered	RP48-SS-FU	\$784	874	922	970	1018	1066	1114	1162	1210	1258	1306	1354	1402

W 22 D 22.5 H 31.75 SH 18

COM Yardage: 1 or 2 chairs: 1 yard
Contact Leland Customer Experience for yardage requirements on textiles with repeats.
For COL requirements please contact Leland Customer Experience.
Optional Glides: Add \$8.00 net per chair for a set of four (4).



**Rapson Forty-Eight
Steel Frame Side Chair**

	MODEL	LIST PRICE
Standard Shell	RP48-SS-MP	\$683
W 22 D 22.5 H 31.75 SH 18		Optional Glides: Add \$8.00 net per chair for a set of four (4).



**Rapson Forty-Eight
Steel Frame Side Chair**

	MODEL	COM/COL	A	B	C	D	E	F	G	H	I	J	K	L
Standard Shell, upholstered seat pad	RP48-SS-MPU	\$762	808	832	856	880	904	928	952	976	1000	1024	1048	1072

W 22 D 22.5 H 31.75 SH 18

COM Yardage: 1 or 2 chairs: 1 yard
Contact Leland Customer Experience for yardage requirements on textiles with repeats.
For COL requirements please contact Leland Customer Experience.
Optional Glides: Add \$8.00 net per chair for a set of four (4).

To specify:
Please refer to pages 3-4 for complete specifying information.
Specify all products by their product code.

Pricing Effective: January 2025

RAPSON FORTY-EIGHT FOUR LEG STEEL FRAME
SIDE CHAIR Design: Ralph Rapson

RP48-C6



**Rapson Forty-Eight
Steel Frame Side Chair**

				MODEL	LIST PRICE
Walnut Shell				RP48-SS-W	\$703
W 22	D 22.5	H 31.75	SH 18	Optional Glides: Add \$8.00 net per chair for a set of four (4).	



**Rapson Forty-Eight
Steel Frame Side Chair**

				MODEL	COM/COL	A	B	C	D	E	F	G	H	I	J	K	L
Walnut Shell, upholstered seat pad				RP48-SS-WU	\$784	829	852	875	898	921	944	967	990	1013	1036	1059	1082
W 22	D 22.5	H 31.75	SH 18	COM Yardage: 1 or 2 chairs: 1 yard Contact Leland Customer Experience for yardage requirements on textiles with repeats. For COL requirements please contact Leland Customer Experience. Optional Glides: Add \$8.00 net per chair for a set of four (4).													



**Rapson Forty-Eight
Steel Frame Side Chair**

				MODEL	LIST PRICE
Premium HPL Shell				RP48-SS-P	\$867
W 22	D 22.5	H 31.75	SH 18	Optional Glides: Add \$8.00 net per chair for a set of four (4).	



**Rapson Forty-Eight
Steel Frame Side Chair**

				MODEL	COM/COL	A	B	C	D	E	F	G	H	I	J	K	L
Premium HPL Shell, upholstered seat pad				RP48-SS-PU	\$948	995	1017	1039	1061	1083	1105	1127	1149	1171	1193	1215	1237
W 22	D 22.5	H 31.75	SH 18	COM Yardage: 1 or 2 chairs: 1 yard Contact Leland Customer Experience for yardage requirements on textiles with repeats. For COL requirements please contact Leland Customer Experience. Optional Glides: Add \$8.00 net per chair for a set of four (4).													

To specify:
Please refer to pages 3-4 for complete specifying information.
Specify all products by their product code.

RAPSON FORTY-EIGHT MAPLE FRAME
SIDE CHAIR Design: Ralph Rapson

RP48-C7

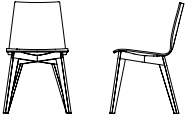

**Rapson Forty-Eight
Maple Frame Side Chair**

		MODEL	LIST PRICE
Standard HPL Shell		RP48-MS-H	\$936
W 19.5	D 21.25	H 32	SH 18.25
Optional Glides: Add \$8.00 net per chair for a set of four (4).			

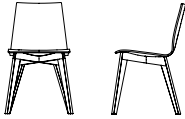

**Rapson Forty-Eight
Maple Frame Side Chair**

		MODEL	COM/COL	A	B	C	D	E	F	G	H	I	J	K	L
Standard HPL Shell, upholstered seat pad		RP48-MS-HU	\$1017	1063	1085	1107	1129	1151	1173	1195	1217	1239	1261	1283	1305
W 19.5	D 21.25	H 32	SH 18.25												

COM Yardage: 1 or 2 chairs: 1 yard
Contact Leland Customer Experience for yardage requirements on textiles with repeats.
For COL requirements please contact Leland Customer Experience.
Optional Glides: Add \$8.00 net per chair for a set of four (4).

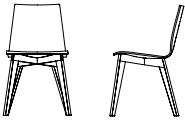

**Rapson Forty-Eight
Maple Frame Side Chair**

		MODEL	COM/COL	A	B	C	D	E	F	G	H	I	J	K	L
Fully Upholstered		RP48-MS-FU	\$1055	1148	1194	1240	1286	1332	1378	1424	1470	1516	1562	1608	1654
W 19.5	D 21.25	H 32	SH 18.25												

COM Yardage: 1 or 2 chairs: 1 yard
Contact Leland Customer Experience for yardage requirements on textiles with repeats.
For COL requirements please contact Leland Customer Experience.
Optional Glides: Add \$8.00 net per chair for a set of four (4).



**Rapson Forty-Eight
Maple Frame Side Chair**

		MODEL	LIST PRICE
Standard Shell		RP48-MS-MP	\$957
W 19.5	D 21.25	H 32	SH 18.25
Optional Glides: Add \$8.00 net per chair for a set of four (4).			

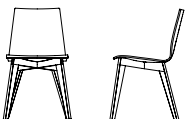

**Rapson Forty-Eight
Maple Frame Side Chair**

		MODEL	COM/COL	A	B	C	D	E	F	G	H	I	J	K	L
Standard Shell, upholstered seat pad		RP48-MS-MPU	\$1035	1082	1106	1130	1154	1178	1202	1226	1250	1274	1298	1322	1346
W 19.5	D 21.25	H 32	SH 18.25												

COM Yardage: 1 or 2 chairs: 1 yard
Contact Leland Customer Experience for yardage requirements on textiles with repeats.
For COL requirements please contact Leland Customer Experience.
Optional Glides: Add \$8.00 net per chair for a set of four (4).

To specify:
Please refer to pages 3-4 for complete specifying information.
Specify all products by their product code.

Pricing Effective: January 2024

RAPSON FORTY-EIGHT MAPLE FRAME
SIDE CHAIR Design: Ralph Rapson

RP48-C8

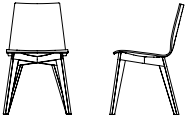

**Rapson Forty-Eight
Maple Frame Side Chair**

		MODEL	LIST PRICE
Walnut Shell		RP48-MS-W	\$975
W 19.5	D 21.25	H 32	SH 18.25
Optional Glides: Add \$8.00 net per chair for a set of four (4).			



**Rapson Forty-Eight
Maple Frame Side Chair**

		MODEL	COM/COL	A	B	C	D	E	F	G	H	I	J	K	L
Walnut Shell, upholstered seat pad		RP48-MS-WU	\$1055	1103	1126	1149	1172	1195	1218	1241	1264	1287	1310	1333	1356
W 19.5	D 21.25	H 32	SH 18.25												
				COM Yardage: 1 or 2 chairs: 1 yard											
				Contact Leland Customer Experience for yardage requirements on textiles with repeats.											
				For COL requirements please contact Leland Customer Experience.											
				Optional Glides: Add \$8.00 net per chair for a set of four (4).											

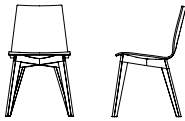

**Rapson Forty-Eight
Maple Frame Side Chair**

		MODEL	LIST PRICE
Premium HPL Shell		RP48-MS-P	\$1141
W 19.5	D 21.25	H 32	SH 18.25
Optional Glides: Add \$8.00 net per chair for a set of four (4).			

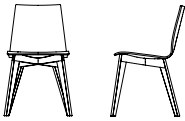

**Rapson Forty-Eight
Maple Frame Side Chair**

		MODEL	COM/COL	A	B	C	D	E	F	G	H	I	J	K	L
Premium HPL Shell, upholstered seat pad		RP48-MS-PU	\$1220	1266	1290	1314	1338	1362	1386	1410	1434	1458	1482	1506	1530
W 19.5	D 21.25	H 32	SH 18.25												
				COM Yardage: 1 or 2 chairs: 1 yard											
				Contact Leland Customer Experience for yardage requirements on textiles with repeats.											
				For COL requirements please contact Leland Customer Experience.											
				Optional Glides: Add \$8.00 net per chair for a set of four (4).											

To specify:
Please refer to pages 3-4 for complete specifying information.
Specify all products by their product code.

RAPSON FORTY-EIGHT FOUR LEG STEEL FRAME
COUNTER CHAIR Design: Ralph Rapson

RP48-C9

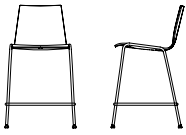

**Rapson Forty-Eight
Steel Frame Counter Chair**

	MODEL	LIST PRICE
Standard HPL Shell	RP48-SC-H	\$937
W 19.75 D 20.75 H 32 SH 24		Optional Glides: Add \$8.00 net per chair for a set of four (4).

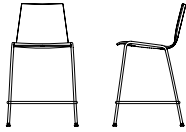

**Rapson Forty-Eight
Steel Frame Counter Chair**

	MODEL	COM/COL	A	B	C	D	E	F	G	H	I	J	K	L
Standard HPL Shell, upholstered seat pad	RP48-SC-HU	\$1018	1064	1086	1108	1130	1152	1174	1196	1218	1240	1262	1284	1306
W 19.75 D 20.75 H 32 SH 24														
			COM Yardage: 1 or 2 chairs: 1.5 yard Contact Leland Customer Experience for yardage requirements on textiles with repeats. For COL requirements please contact Leland Customer Experience. Optional Glides: Add \$8.00 net per chair for a set of four (4).											

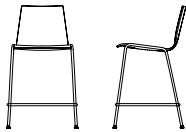

**Rapson Forty-Eight
Steel Frame Counter Chair**

	MODEL	COM/COL	A	B	C	D	E	F	G	H	I	J	K	L
Fully Upholstered	RP48-SC-FU	\$1056	1150	1195	1240	1285	1330	1375	1420	1465	1510	1555	1600	1645
W 19.75 D 20.75 H 32 SH 24														
			COM Yardage: 1 or 2 chairs: 1 yard Contact Leland Customer Experience for yardage requirements on textiles with repeats. For COL requirements please contact Leland Customer Experience. Optional Glides: Add \$8.00 net per chair for a set of four (4).											

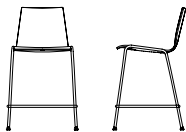

**Rapson Forty-Eight
Steel Frame Counter Chair**

	MODEL	LIST PRICE
Standard Shell	RP48-SC-MP	\$958
W 19.75 D 20.75 H 32 SH 24		Optional Glides: Add \$8.00 net per chair for a set of four (4).



**Rapson Forty-Eight
Steel Frame Counter Chair**

	MODEL	COM/COL	A	B	C	D	E	F	G	H	I	J	K	L
Standard Shell, upholstered seat pad	RP48-SC-MPU	\$1037	1083	1107	1131	1155	1179	1203	1227	1251	1275	1299	1323	1347
W 19.75 D 20.75 H 32 SH 24														
			COM Yardage: 1 or 2 chairs: 1 yard Contact Leland Customer Experience for yardage requirements on textiles with repeats. For COL requirements please contact Leland Customer Experience. Optional Glides: Add \$8.00 net per chair for a set of four (4).											

To specify:
Please refer to pages 3-4 for complete specifying information.
Specify all products by their product code.

Pricing Effective: January 2025

RAPSON FORTY-EIGHT FOUR LEG STEEL FRAME
COUNTER CHAIR Design: Ralph Rapson

RP48-C10

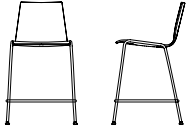

**Rapson Forty-Eight
Steel Frame Counter Chair**

				MODEL	LIST PRICE
Walnut Shell				RP48-SC-W	\$977
W 19.75	D 20.75	H 32	SH 24	Optional Glides: Add \$8.00 net per chair for a set of four (4).	

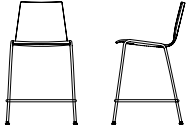

**Rapson Forty-Eight
Steel Frame Counter Chair**

				MODEL	COM/COL	A	B	C	D	E	F	G	H	I	J	K	L
Walnut Shell, upholstered seat pad				RP48-SC-WU	\$1056	1104	1127	1150	1173	1196	1219	1242	1265	1288	1311	1334	1357
W 19.75	D 20.75	H 32	SH 24	COM Yardage: 1 or 2 chairs: 1 yard Contact Leland Customer Experience for yardage requirements on textiles with repeats. For COL requirements please contact Leland Customer Experience. Optional Glides: Add \$8.00 net per chair for a set of four (4).													

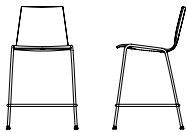

**Rapson Forty-Eight
Steel Frame Counter Chair**

				MODEL	LIST PRICE
Premium HPL Shell				RP48-SC-P	\$1142
W 19.75	D 20.75	H 32	SH 24	Optional Glides: Add \$8.00 net per chair for a set of four (4).	

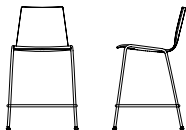

**Rapson Forty-Eight
Steel Frame Counter Chair**

				MODEL	COM/COL	A	B	C	D	E	F	G	H	I	J	K	L
Premium HPL Shell, upholstered seat pad				RP48-SC-PU	\$1222	1263	1287	1311	1335	1359	1383	1407	1431	1455	1479	1503	1527
W 19.75	D 20.75	H 32	SH 24	COM Yardage: 1 or 2 chairs: 1 yard Contact Leland Customer Experience for yardage requirements on textiles with repeats. For COL requirements please contact Leland Customer Experience. Optional Glides: Add \$8.00 net per chair for a set of four (4).													

To specify:
Please refer to pages 3-4 for complete specifying information.
Specify all products by their product code.

Pricing Effective: January 2025

RAPSON FORTY-EIGHT MAPLE FRAME
COUNTER CHAIR Design: Ralph Rapson

RP48-C11

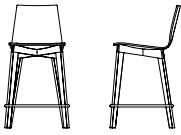

**Rapson Forty-Eight
Maple Frame Counter Chair**

	MODEL	LIST PRICE
Standard HPL Shell	RP48-MC-H	\$1484
W 18.5 D 20 H 35 SH 24		Optional Glides: Add \$8.00 net per chair for a set of four (4).

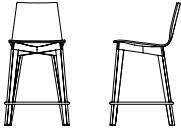

**Rapson Forty-Eight
Maple Frame Counter Chair**

	MODEL	COM/COL	A	B	C	D	E	F	G	H	I	J	K	L
Standard HPL Shell, upholstered seat pad	RP48-MC-HU	\$1564	1610	1633	1656	1679	1702	1725	1748	1771	1794	1817	1840	1863

W 18.5 D 20 H 35 SH 24

COM Yardage: 1 or 2 chairs: 1 yard
Contact Leland Customer Experience for yardage requirements on textiles with repeats.
For COL requirements please contact Leland Customer Experience.
Optional Glides: Add \$8.00 net per chair for a set of four (4).

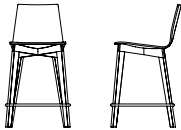

**Rapson Forty-Eight
Maple Frame Counter Chair**

	MODEL	COM/COL	A	B	C	D	E	F	G	H	I	J	K	L
Fully Upholstered	RP48-MC-FU	\$1603	1695	1742	1789	1836	1883	1930	1977	2024	2071	2118	2165	2212

W 18.5 D 20 H 35 SH 24

COM Yardage: 1 or 2 chairs: 1 yard
Contact Leland Customer Experience for yardage requirements on textiles with repeats.
For COL requirements please contact Leland Customer Experience.
Optional Glides: Add \$8.00 net per chair for a set of four (4).

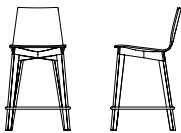

**Rapson Forty-Eight
Maple Frame Counter Chair**

	MODEL	LIST PRICE
Standard Shell	RP48-MC-MP	\$1503
W 18.5 D 20 H 35 SH 24		Optional Glides: Add \$8.00 net per chair for a set of four (4).



**Rapson Forty-Eight
Maple Frame Counter Chair**

	MODEL	COM/COL	A	B	C	D	E	F	G	H	I	J	K	L
Standard Shell, upholstered seat pad	RP48-MC-MPU	\$1583	1629	1651	1673	1695	1717	1739	1761	1783	1805	1827	1849	1871

W 18.5 D 20 H 35 SH 24

COM Yardage: 1 or 2 chairs: 1 yard
Contact Leland Customer Experience for yardage requirements on textiles with repeats.
For COL requirements please contact Leland Customer Experience.
Optional Glides: Add \$8.00 net per chair for a set of four (4).

To specify:
Please refer to pages 3-4 for complete specifying information.
Specify all products by their product code.

Pricing Effective: January 2025

RAPSON FORTY-EIGHT MAPLE FRAME
COUNTER CHAIR Design: Ralph Rapson

RP48-C12

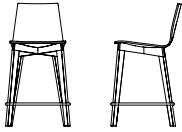

**Rapson Forty-Eight
Maple Frame Counter Chair**

		MODEL	LIST PRICE
Walnut Shell		RP48-MC-W	\$1660
W 18.5	D 20	H 35	SH 24

Optional Glides: Add \$8.00 net per chair for a set of four (4).

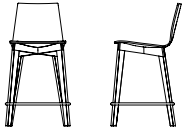

**Rapson Forty-Eight
Maple Frame Counter Chair**

		MODEL	COM/COL	A	B	C	D	E	F	G	H	I	J	K	L
Walnut Shell, upholstered seat pad		RP48-MC-WU	\$1739	1785	1809	1833	1857	1881	1905	1929	1953	1977	2001	2025	2049
W 18.5	D 20	H 35	SH 24												

COM Yardage: 1 or 2 chairs: 1 yard
Contact Leland Customer Experience for yardage requirements on textiles with repeats.
For COL requirements please contact Leland Customer Experience.
Optional Glides: Add \$8.00 net per chair for a set of four (4).

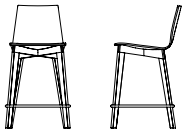

**Rapson Forty-Eight
Maple Frame Counter Chair**

		MODEL	LIST PRICE
Premium HPL Shell		RP48-MC-P	\$1824
W 18.5	D 20	H 35	SH 24

Optional Glides: Add \$8.00 net per chair for a set of four (4).

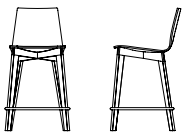

**Rapson Forty-Eight
Maple Frame Counter Chair**

		MODEL	COM/COL	A	B	C	D	E	F	G	H	I	J	K	L
Premium HPL Shell, upholstered seat pad		RP48-MC-PU	\$1903	1949	1972	1995	2018	2041	2064	2087	2110	2133	2156	2179	2202
W 18.5	D 20	H 35	SH 24												

COM Yardage: 1 or 2 chairs: 1 yard
Contact Leland Customer Experience for yardage requirements on textiles with repeats.
For COL requirements please contact Leland Customer Experience.
Optional Glides: Add \$8.00 net per chair for a set of four (4).

To specify:
Please refer to pages 3-4 for complete specifying information.
Specify all products by their product code.

Pricing Effective: January 2025

RAPSON FORTY-EIGHT FOUR LEG STEEL FRAME
BAR CHAIR Design: Ralph Rapson

RP48-C13

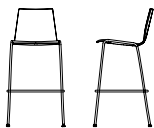

**Rapson Forty-Eight
Steel Frame Bar Chair**

				MODEL	LIST PRICE
Standard HPL Shell				RP48-SB-H	\$953
W 20	D 23	H 41	SH 30	Optional Glides: Add \$8.00 net per chair for a set of four (4).	

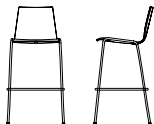

**Rapson Forty-Eight
Steel Frame Bar Chair**

				MODEL	COM/COL	A	B	C	D	E	F	G	H	I	J	K	L
Standard HPL Shell, upholstered seat pad				RP48-SB-HU	\$1033	1080	1103	1126	1149	1172	1195	1218	1241	1264	1287	1310	1333

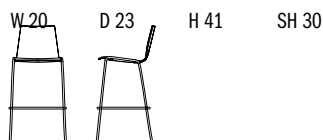

COM Yardage: 1 or 2 chairs: 1.5 yard
Contact Leland Customer Experience for yardage requirements on textiles with repeats.
For COL requirements please contact Leland Customer Experience.
Optional Glides: Add \$8.00 net per chair for a set of four (4).

**Rapson Forty-Eight
Steel Frame Bar Chair**

				MODEL	COM/COL	A	B	C	D	E	F	G	H	I	J	K	L
Fully Upholstered				RP48-SB-FU	\$1072	1164	1212	1260	1308	1356	1404	1452	1500	1548	1596	1644	1692

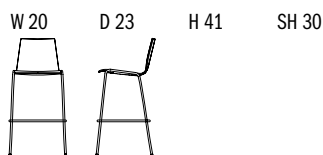

COM Yardage: 1 or 2 chairs: 1 yard
Contact Leland Customer Experience for yardage requirements on textiles with repeats.
For COL requirements please contact Leland Customer Experience.
Optional Glides: Add \$8.00 net per chair for a set of four (4).

**Rapson Forty-Eight
Steel Frame Bar Chair**

				MODEL	LIST PRICE
Standard Shell				RP48-SB-MP	\$973
W 20	D 23	H 41	SH 30	Optional Glides: Add \$8.00 net per chair for a set of four (4).	

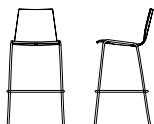

**Rapson Forty-Eight
Steel Frame Bar Chair**

				MODEL	COM/COL	A	B	C	D	E	F	G	H	I	J	K	L
Standard Shell, upholstered seat pad				RP48-SB-MPU	\$1052	1099	1122	1145	1168	1191	1214	1237	1260	1283	1306	1329	1352



COM Yardage: 1 or 2 chairs: 1 yard
Contact Leland Customer Experience for yardage requirements on textiles with repeats.
For COL requirements please contact Leland Customer Experience.
Optional Glides: Add \$8.00 net per chair for a set of four (4).

To specify:
Please refer to pages 3-4 for complete specifying information.
Specify all products by their product code.

Pricing Effective: January 2025

RAPSON FORTY-EIGHT FOUR LEG STEEL FRAME
BAR CHAIR Design: Ralph Rapson

RP48-C14

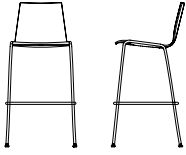

**Rapson Forty-Eight
Steel Frame Bar Chair**

				MODEL	LIST PRICE
Walnut Shell				RP48-SB-W	\$996
W 20	D 23	H 41	SH 30	Optional Glides: Add \$8.00 net per chair for a set of four (4).	



**Rapson Forty-Eight
Steel Frame Bar Chair**

				MODEL	COM/COL	A	B	C	D	E	F	G	H	I	J	K	L
Walnut Shell, upholstered seat pad				RP48-SB-WU	\$1074	1119	1143	1167	1191	1215	1239	1263	1287	1311	1335	1359	1383

W 20 D 23 H 41 SH 30

COM Yardage: 1 or 2 chairs: 1 yard
Contact Leland Customer Experience for yardage requirements on textiles with repeats.
For COL requirements please contact Leland Customer Experience.
Optional Glides: Add \$8.00 net per chair for a set of four (4).



**Rapson Forty-Eight
Steel Frame Bar Chair**

				MODEL	LIST PRICE
Premium HPL Shell				RP48-SB-P	\$1158
W 20	D 23	H 41	SH 30	Optional Glides: Add \$8.00 net per chair for a set of four (4).	



**Rapson Forty-Eight
Steel Frame Bar Chair**

				MODEL	COM/COL	A	B	C	D	E	F	G	H	I	J	K	L
Premium HPL Shell, upholstered seat pad				RP48-SB-PU	\$1112	1274	1298	1322	1346	1370	1394	1418	1442	1466	1490	1514	1538

W 20 D 23 H 41 SH 30

COM Yardage: 1 or 2 chairs: 1 yard
Contact Leland Customer Experience for yardage requirements on textiles with repeats.
For COL requirements please contact Leland Customer Experience.
Optional Glides: Add \$8.00 net per chair for a set of four (4).

To specify:
Please refer to pages 3-4 for complete specifying information.
Specify all products by their product code.

RAPSON FORTY-EIGHT MAPLE FRAME
BAR CHAIR Design: Ralph Rapson

RP48-C15



**Rapson Forty-Eight
Maple Frame Bar Chair**

		MODEL	LIST PRICE
Standard HPL Shell		RP48-MB-H	\$1773
W 18.5	D 20	H 35	SH 24
Optional Glides: Add \$8.00 net per chair for a set of four (4).			



**Rapson Forty-Eight
Maple Frame Bar Chair**

		MODEL	COM/COL	A	B	C	D	E	F	G	H	I	J	K	L
Standard HPL Shell, upholstered seat pad		RP48-MB-HU	\$1851	1897	1921	1945	1969	1993	2017	2041	2065	2089	2113	2137	2161
W 18.5	D 20	H 35	SH 24	COM Yardage: 1 or 2 chairs: 1 yard Contact Leland Customer Experience for yardage requirements on textiles with repeats. For COL requirements please contact Leland Customer Experience. Optional Glides: Add \$8.00 net per chair for a set of four (4).											



**Rapson Forty-Eight
Maple Frame Bar Chair**

		MODEL	COM/COL	A	B	C	D	E	F	G	H	I	J	K	L
Fully Upholstered		RP48-MB-FU	\$1892	1984	2030	2076	2122	2168	2214	2260	2306	2352	2398	2444	2490
W 18.5	D 20	H 35	SH 24	COM Yardage: 1 or 2 chairs: 1 yard Contact Leland Customer Experience for yardage requirements on textiles with repeats. For COL requirements please contact Leland Customer Experience. Optional Glides: Add \$8.00 net per chair for a set of four (4).											



**Rapson Forty-Eight
Maple Frame Bar Chair**

		MODEL	LIST PRICE
Standard Shell		RP48-MB-MP	\$1792
W 18.5	D 20	H 35	SH 24
Optional Glides: Add \$8.00 net per chair for a set of four (4).			



**Rapson Forty-Eight
Maple Frame Bar Chair**

		MODEL	COM/COL	A	B	C	D	E	F	G	H	I	J	K	L
Standard Shell, upholstered seat pad		RP48-MB-MPU	\$1872	1919	1941	1963	1985	2007	2029	2051	2073	2095	2117	2139	2161
W 18.5	D 20	H 35	SH 24	COM Yardage: 1 or 2 chairs: 1 yard Contact Leland Customer Experience for yardage requirements on textiles with repeats. For COL requirements please contact Leland Customer Experience. Optional Glides: Add \$8.00 net per chair for a set of four (4).											

To specify:
 Please refer to pages 3-4 for complete specifying information.
 Specify all products by their product code.
 Pricing Effective: January 2025

RAPSON FORTY-EIGHT FOUR MAPLE FRAME
BAR CHAIR Design: Ralph Rapson

RP48-C16



**Rapson Forty-Eight
Maple Frame Bar Chair**

				MODEL	LIST PRICE
Walnut Shell				RP48-MB-W	\$1949
W 18.5	D 20	H 35	SH 24	Optional Glides: Add \$8.00 net per chair for a set of four (4).	



**Rapson Forty-Eight
Maple Frame Bar Chair**

				MODEL	COM/COL	A	B	C	D	E	F	G	H	I	J	K
Walnut Shell, upholstered seat pad				RP48-MB-WU	\$2029	2075	2099	2123	2147	2171	2195	2219	2243	2267	2291	2315
W 18.5	D 20	H 35	SH 24	COM Yardage: 1 or 2 chairs: 1 yard Contact Leland Customer Experience for yardage requirements on textiles with repeats. For COL requirements please contact Leland Customer Experience. Optional Glides: Add \$8.00 net per chair for a set of four (4).												

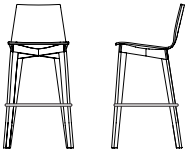

**Rapson Forty-Eight
Maple Frame Bar Chair**

				MODEL	LIST PRICE
Premium HPL Shell				RP48-MB-P	\$2113
W 18.5	D 20	H 35	SH 24	Optional Glides: Add \$8.00 net per chair for a set of four (4).	



**Rapson Forty-Eight
Maple Frame Bar Chair**

				MODEL	COM/COL	A	B	C	D	E	F	G	H	I	J	K	L
Premium HPL Shell, upholstered seat pad				RP48-MB-PU	\$2191	2239	2263	2287	2311	2335	2359	2383	2407	2431	2455	2479	2503
W 18.5	D 20	H 35	SH 24	COM Yardage: 1 or 2 chairs: 1 yard Contact Leland Customer Experience for yardage requirements on textiles with repeats. For COL requirements please contact Leland Customer Experience. Optional Glides: Add \$8.00 net per chair for a set of four (4).													

To specify:
Please refer to pages 3-4 for complete specifying information.
Specify all products by their product code.

Painted Back	MODEL	LIST PRICE
	Reference color codes on page RP48-C3	\$206

Handhold	MODEL	LIST PRICE
	HH	\$37

To specify:
Please refer to pages 3-4 for
complete specifying information.
Specify all products by their
product code.

**5695 Eagle Drive, SE
Grand Rapids,
Michigan 49512
616-975-9260
lelandfurniture.com**

Rapson Thirty-Nine Bench

January 2025 Price List



Rapson Thirty-Nine Bench

Table of Contents	RP39-BN2
Specification Information	RP39-BN3
Specification Example	RP39-BN4
Rapson Thirty-Nine Bench 20"	RP39-BN5
Rapson Thirty-Nine Bench 48"	RP39-BN5

Bench Model

DESCRIPTION	CODE
Rapson Thirty-Nine Bench	RP39-BN

Bench Width

DESCRIPTION	CODE
20"	20
48"	48

Bench Frame and Button Finish Options

DESCRIPTION	CODE
Natural Walnut	08M
Natural Ash	07M

Upholstery Selection

Please refer to Leland Textile Program which features textiles and leathers from the following partners:

- Camira
- Green Hides
- Carnegie
- Maharam
- CF Stinson
- Unika Vaev

The complete grade list can be found at lelandinternational.com/ecatalog or you can specify COM/COL. Due to the design of this product, it is recommended that all non pre-approved textile be tested for compatibility.

Glide Option

DESCRIPTION	CODE
Nylon (standard)	S
Felt	F

RAPSON THIRTY-NINE BENCH SPECIFICATION EXAMPLE

RP39-BN4

Specifications required to create the product code

- Model
- Bench Width
- Bench Frame and Button Finish Selection
- Upholstery Selection
- Glide Option

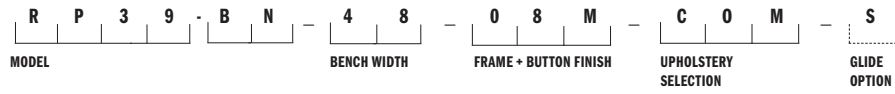

MODEL

Rapson Thirty-Nine Bench (RP39-BN)

BENCH WIDTH

48" (48)

BENCH FRAME + BUTTON FINISH

Natural Walnut (08M)

UPHOLSTERY SELECTION

Enter upholstery grade or COM

GLIDE OPTION

Nylon (S)



RAPSON THIRTY-NINE BENCH
 Design: Ralph Rapson

RP39-BN5

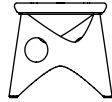
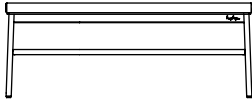

Rapson Thirty-Nine	MODEL	COM/COL	A	B	C	D	E	F	G	H	I	J	K	L
48" Bench	RP39-BN-48	\$2294	2388	2436	2484	2530	2578	2625	2672	2719	2766	2812	2860	2907

W 48.5 D 19.25 H 18.5

COM Yardage: 1.5 yards

Contact Leland Customer Experience for yardage requirements on textiles with repeats.

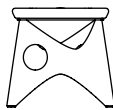

Rapson Thirty-Nine	MODEL	COM/COL	A	B	C	D	E	F	G	H	I	J	K	L
20" Bench	RP39-BN-20	\$1435	1467	1484	1498	1515	1531	1545	1561	1576	1593	1607	1624	1639

W 19.5 D 19.25 H 18.5

COM Yardage: 1.5 yards

Contact Leland Customer Experience for yardage requirements on textiles with repeats.

To specify:

Please refer to pages 3-4 for complete specifying information. Specify all products by their product code.

Pricing Effective: January 2025

**5695 Eagle Drive, SE
Grand Rapids,
Michigan 49512
616-975-9260
lelandfurniture.com**

Rapson Thirty-Nine Guest

January 2025 Price List



Rapson Thirty-Nine Guest

Table of Contents	RP39-G2
Specification Information	RP39-G3
Specification Example	RP39-G4
Guest Chair	RP39-G5

Chair Model

DESCRIPTION	CODE
Rapson Thirty-Nine Guest Chair	RP39-G

Frame Finish Options

DESCRIPTION	CODE
Natural Walnut	08M
Natural Ash	07M

Fully Upholstered or Onlay Selection

Please refer to Leland Textile Program which features textiles and leathers from the following partners:

- Camira
- Carnegie
- CF Stinson
- Green Hides
- Maharam
- Unika Vaev

The complete grade list can be found at www.lelandfurniture.com/ecatalog or you can specify COM/COL. Due to the design of this product, it is recommended that all non pre-approved textile be tested for compatibility.

Optional Contrasted Upper Back Upholstery

Please refer to Leland Textile Program which features textiles and leathers from the following partners:

- Camira
- Carnegie
- CF Stinson
- Green Hides
- Maharam
- Unika Vaev

The complete grade list can be found at www.lelandfurniture.com/ecatalog or you can specify COM/COL. Due to the design of this product, it is recommended that all non pre-approved textile be tested for compatibility.

Glide Option

DESCRIPTION	CODE
Nylon (standard)	S
Felt	F

Specifications required to create the product code

- Model
- Frame Finish Selection
- Upholstery Selection
- Optional Upper Back Upholstery
- Glide Option

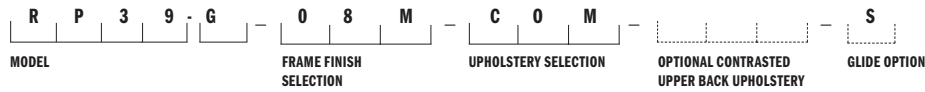

MODEL

Rapson Thirty-Nine Guest (RP39-G)

FRAME FINISH

Natural Walnut (08M)

UPHOLSTERY SELECTION

Enter upholstery grade or COM

GLIDE OPTION

Nylon (S)



RAPSON THIRTY-NINE GUEST
 Design: Ralph Rapson

RP39-G5

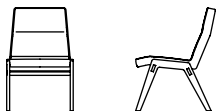

Rapson Thirty-Nine				MODEL	COM/COL	A	B	C	D	E	F	G	H	I	J	K	L
Guest Chair				RP39-G	\$2728	2822	2870	2917	2965	3011	3059	3106	3152	3200	3247	3293	3341
W 22	D 27	H 35	SH 18.5	COM Yardage: 1 seat: 2.75 yards													

Contact Leland Customer Experience for yardage requirements on textiles with repeats.

Optional Glides: Add \$8.00 net per chair for a set of four (4).

To specify:

Please refer to pages 3-4 for complete specifying information.

Specify all products by their product code.

Pricing Effective: January 2025

5695 Eagle Drive, SE
Grand Rapids,
Michigan 49512
616-975-9260
lelandfurniture.com

Rapson Thirty-Nine Lounge

January 2025 Price List



Rapson Thirty-Nine Lounge

Table of Contents	RP39-L2
Specification Information	RP39-L3
Specification Example	RP39-L4
Rapson Thirty-Nine Lounge	RP39-L5

Chair Model

DESCRIPTION	CODE
Rapson Thirty-Nine Lounge Chair	RP39-L

Frame Finish Options

DESCRIPTION	CODE
Natural Walnut	08M
Natural Ash	07M

Fully Upholstered or Onlay Selection

Please refer to Leland Textile Program which features textiles and leathers from the following partners:

- Camira
- Carnegie
- CF Stinson
- Green Hides
- Maharam
- Unika Vaev

The complete grade list can be found at www.lelandfurniture.com/ecatalog or you can specify COM/COL. Due to the design of this product, it is recommended that all non pre-approved textile be tested for compatibility.

Glide Option

DESCRIPTION	CODE
Nylon (standard)	S
Felt	F

Specifications required to create the product code

- Model
- Frame Finish Selection
- Upholstery Selection
- Glide Option

R **P** **3** **9** - **L** - **0** **8** **M** - **C** **O** **M** - **S**
MODEL FRAME FINISH UPHOLSTERY SELECTION GLIDE
OPTION

MODEL

Rapson Thirty-Nine Lounge (RP39-L)

FRAME FINISH

Natural Walnut (08M)

UPHOLSTERY SELECTION

Enter upholstery grade or COM

GLIDE OPTION

Nylon (S)



RAPSON THIRTY-NINE LOUNGE
 Design: Ralph Rapson

RP39-L5



Rapson Thirty-Nine				MODEL	COM/COL	A	B	C	D	E	F	G	H	I	J	K	L
Lounge Chair				RP39-L	\$3232	3343	3398	3453	3509	3563	3618	3673	3728	3784	3838	3893	3950
W 24	D 32.25	H 31	SH 18.25	COM Yardage: 1 seat: 1.75 yards													

Contact Leland Customer Experience for yardage requirements on textiles with repeats.

Optional Glides: Add \$8.00 net per chair for a set of four (4).

To specify:
 Please refer to pages 3-4 for complete specifying information.
 Specify all products by their product code.

Pricing Effective: January 2025

5695 Eagle Drive, SE
Grand Rapids,
Michigan 49512
616-975-9260
lelandfurniture.com

Rapson Thirty-Nine Bench

January 2025 Price List



Rapson Thirty-Nine Bench

Table of Contents	RP39-BN2
Specification Information	RP39-BN3
Specification Example	RP39-BN4
Rapson Thirty-Nine Bench 20"	RP39-BN5
Rapson Thirty-Nine Bench 48"	RP39-BN5

Bench Model

DESCRIPTION	CODE
Rapson Thirty-Nine Bench	RP39-BN

Bench Width

DESCRIPTION	CODE
20"	20
48"	48

Bench Frame and Button Finish Options

DESCRIPTION	CODE
Natural Walnut	08M
Natural Ash	07M

Upholstery Selection

Please refer to Leland Textile Program which features textiles and leathers from the following partners:

- Camira
- Green Hides
- Carnegie
- Maharam
- CF Stinson
- Unika Vaev

The complete grade list can be found at lelandinternational.com/ecatalog or you can specify COM/COL. Due to the design of this product, it is recommended that all non pre-approved textile be tested for compatibility.

Glide Option

DESCRIPTION	CODE
Nylon (standard)	S
Felt	F

RAPSON THIRTY-NINE BENCH SPECIFICATION EXAMPLE

RP39-BN4

Specifications required to create the product code

- Model
- Bench Width
- Bench Frame and Button Finish Selection
- Upholstery Selection
- Glide Option

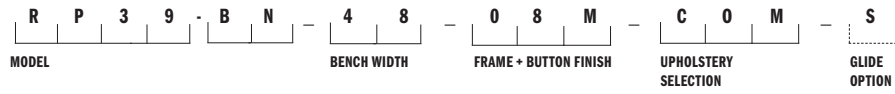

MODEL

Rapson Thirty-Nine Bench (RP39-BN)

BENCH WIDTH

48" (48)

BENCH FRAME + BUTTON FINISH

Natural Walnut (08M)

UPHOLSTERY SELECTION

Enter upholstery grade or COM

GLIDE OPTION

Nylon (S)



RAPSON THIRTY-NINE BENCH
 Design: Ralph Rapson

RP39-BN5

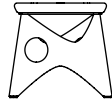
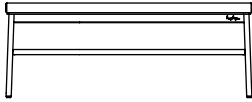

Rapson Thirty-Nine	MODEL	COM/COL	A	B	C	D	E	F	G	H	I	J	K	L
48" Bench	RP39-BN-48	\$2294	2388	2436	2484	2530	2578	2625	2672	2719	2766	2812	2860	2907

W 48.5 D 19.25 H 18.5

COM Yardage: 1.5 yards

Contact Leland Customer Experience for yardage requirements on textiles with repeats.

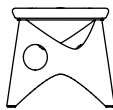

Rapson Thirty-Nine	MODEL	COM/COL	A	B	C	D	E	F	G	H	I	J	K	L
20" Bench	RP39-BN-20	\$1435	1467	1484	1498	1515	1531	1545	1561	1576	1593	1607	1624	1639

W 19.5 D 19.25 H 18.5

COM Yardage: 1.5 yards

Contact Leland Customer Experience for yardage requirements on textiles with repeats.

To specify:

Please refer to pages 3-4 for complete specifying information. Specify all products by their product code.

Pricing Effective: January 2025

5695 Eagle Drive, SE
Grand Rapids,
Michigan 49512
616-975-9260
lelandfurniture.com

Rapson Thirty-Nine Guest

January 2025 Price List



Rapson Thirty- Nine Guest

Table of Contents	RP39-G2
Specification Information	RP39-G3
Specification Example	RP39-G4
Guest Chair	RP39-G5

Chair Model

DESCRIPTION	CODE
Rapson Thirty-Nine Guest Chair	RP39-G

Frame Finish Options

DESCRIPTION	CODE
Natural Walnut	08M
Natural Ash	07M

Fully Upholstered or Onlay Selection

Please refer to Leland Textile Program which features textiles and leathers from the following partners:

- Camira
- Carnegie
- CF Stinson
- Green Hides
- Maharam
- Unika Vaev

The complete grade list can be found at www.lelandfurniture.com/ecatalog or you can specify COM/COL. Due to the design of this product, it is recommended that all non pre-approved textile be tested for compatibility.

Optional Contrasted Upper Back Upholstery

Please refer to Leland Textile Program which features textiles and leathers from the following partners:

- Camira
- Carnegie
- CF Stinson
- Green Hides
- Maharam
- Unika Vaev

The complete grade list can be found at www.lelandfurniture.com/ecatalog or you can specify COM/COL. Due to the design of this product, it is recommended that all non pre-approved textile be tested for compatibility.

Glide Option

DESCRIPTION	CODE
Nylon (standard)	S
Felt	F

Specifications required to create the product code

- Model
- Frame Finish Selection
- Upholstery Selection
- Optional Upper Back Upholstery
- Glide Option



MODEL

Rapson Thirty-Nine Guest (RP39-G)

FRAME FINISH

Natural Walnut (08M)

UPHOLSTERY SELECTION

Enter upholstery grade or COM

GLIDE OPTION

Nylon (S)



RAPSON THIRTY-NINE GUEST
 Design: Ralph Rapson

RP39-G5

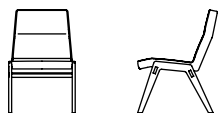

Rapson Thirty-Nine				MODEL	COM/COL	A	B	C	D	E	F	G	H	I	J	K	L
Guest Chair				RP39-G	\$2728	2822	2870	2917	2965	3011	3059	3106	3152	3200	3247	3293	3341
W 22	D 27	H 35	SH 18.5	COM Yardage: 1 seat: 2.75 yards													

Contact Leland Customer Experience for yardage requirements on textiles with repeats.

Optional Glides: Add \$8.00 net per chair for a set of four (4).

To specify:

Please refer to pages 3-4 for complete specifying information.

Specify all products by their product code.

Pricing Effective: January 2025

**5695 Eagle Drive, SE
Grand Rapids,
Michigan 49512
616-975-9260
lelandfurniture.com**

Rapson Thirty-Nine Lounge

January 2025 Price List



Rapson Thirty-Nine Lounge

Table of Contents	RP39-L2
Specification Information	RP39-L3
Specification Example	RP39-L4
Rapson Thirty-Nine Lounge	RP39-L5

Chair Model

DESCRIPTION	CODE
Rapson Thirty-Nine Lounge Chair	RP39-L

Frame Finish Options

DESCRIPTION	CODE
Natural Walnut	08M
Natural Ash	07M

Fully Upholstered or Onlay Selection

Please refer to Leland Textile Program which features textiles and leathers from the following partners:

- Camira
- Carnegie
- CF Stinson
- Green Hides
- Maharam
- Unika Vaev

The complete grade list can be found at www.lelandfurniture.com/ecatalog or you can specify COM/COL. Due to the design of this product, it is recommended that all non pre-approved textile be tested for compatibility.

Glide Option

DESCRIPTION	CODE
Nylon (standard)	S
Felt	F

Specifications required to create the product code

- Model
- Frame Finish Selection
- Upholstery Selection
- Glide Option

R P 3 9 - L - **0 8 M** - **C O M** - **S**
MODEL FRAME FINISH UPHOLSTERY SELECTION GLIDE OPTION

MODEL

Rapson Thirty-Nine Lounge (RP39-L)

FRAME FINISH

Natural Walnut (08M)

UPHOLSTERY SELECTION

Enter upholstery grade or COM

GLIDE OPTION

Nylon (S)



RAPSON THIRTY-NINE LOUNGE
 Design: Ralph Rapson

RP39-L5



Rapson Thirty-Nine				MODEL	COM/COL	A	B	C	D	E	F	G	H	I	J	K	L
Lounge Chair				RP39-L	\$3232	3343	3398	3453	3509	3563	3618	3673	3728	3784	3838	3893	3950
W 24	D 32.25	H 31	SH 18.25	COM Yardage: 1 seat: 1.75 yards													

Contact Leland Customer Experience for yardage requirements on textiles with repeats.

Optional Glides: Add \$8.00 net per chair for a set of four (4).

To specify:

Please refer to pages 3-4 for complete specifying information.

Specify all products by their product code.

Pricing Effective: January 2025

5695 Eagle Drive, SE
Grand Rapids,
Michigan 49512
616-975-9260
lelandfurniture.com

Slam Beam

January 2025 Price List



Slam Beam

Table of Contents	SB2
Configurative Overview	SB3
Order Diagram	SB4
Visual Reference	SB5
Specification Information	SB8
Specification Example	SB9
Base, Two Position	SB10
Base, Three Position	SB11
Base, Four Position	SB12
Shell Specification Information	SB13
Specification Example	SB14
Shell Selection	SB15
Table Specification Information	SB17
Table Specification Example	SB18
Table	SB19
Floor Mount	SB20

Slam Beam Seating Configuration

Slam Beam can be configured in many ways to meet the needs of your public space. The following pages will provide you a step by step process to correctly configure your benches. **Each purchase order submitted requires the diagram on page SB17 of this price list to be completed for every different bench model.** This is to ensure that the product you receive is exactly what you intended to purchase. If Leland can be of any assistance to you, please don't hesitate to contact our Customer Experience Department at 800-859-7510.

1. Base Selection

Begin configuring Slam Beam by selecting a base. Bases are available in three or four positions, either with arms or armless.

2. Shell Added to Base

The Slam shell is designed to fit one base position. Shells are available in polypropylene or 3D Veneer with or without upholstery. When placing an order, each shell is considered a separate product and will require its own model number.

3. Table Added to Base (Optional)

Slam Beam tables fit one base position. Table surface selections are available as a laminate. When placing an order, each table is considered a separate product and will require its own model number.

Please complete and include with your order. If multiple units are ordered, a diagram must be completed for each unique unit.

1. Slam Beam Base Selection

Select a three position or four position base model number:

The gray boxes below represent the seat/table positions of the model. Specify from left to right as seated. *Note diagram (bottom is front of bench).

TWO (2) POSITION

SB2NA, two position, armless

SB22A, two position, two arm

SB23A, two position, three arm

THREE (3) POSITION

SB3NA, three position, armless

SB32A, three position, two arm

SB34A, three position, four arm

FOUR (4) POSITION

SB4NA, four position, armless

SB42A, four position, two arm

SB45A, four position, five arm

2. SLAM BEAM SHELL AND TABLE SELECTION

Please select either a shell or a table for each position on your base. Then choose the surface materials. Positions should be specified from left to right as seated.

POSITION ONE POSITION TWO

Shell

Polypropylene

Polypropylene

w/ Uph. Seat Onlay

Fully Uph.

Oak 3D Veneer

Oak 3D Veneer w/

Uph. Seat Onlay

Tables

POSITION THREE

Shell

Polypropylene

Polypropylene

w/ Uph. Seat Onlay

Fully Uph.

Oak 3D Veneer

Oak 3D Veneer w/

Uph. Seat Onlay

Tables

POSITION FOUR

Shell

Polypropylene

Polypropylene

w/ Uph. Seat Onlay

Fully Uph.

Oak 3D Veneer

Oak 3D Veneer w/

Uph. Seat Onlay

Tables

POSITION FOUR

Shell

Polypropylene

Polypropylene

w/ Uph. Seat Onlay

Fully Uph.

Oak 3D Veneer

Oak 3D Veneer w/

Uph. Seat Onlay

Tables

TWO POSITION ARMLESS

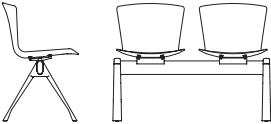

TWO POSITION, TWO ARM

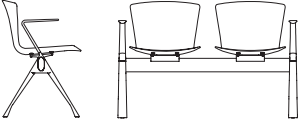

TWO POSITION, THREE ARM

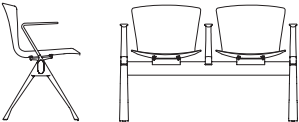

THREE POSITION ARMLESS

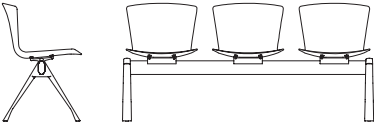

THREE POSITION, TWO ARM

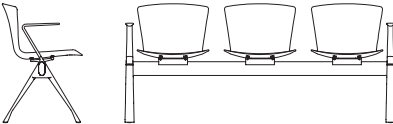

THREE POSITION, FOUR ARM

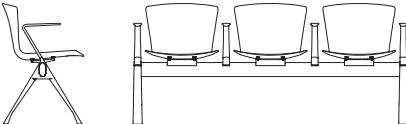

FOUR POSITION ARMLESS

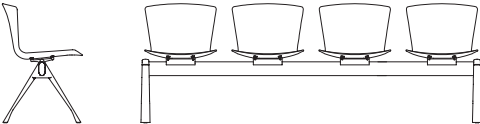

FOUR POSITION, TWO ARM

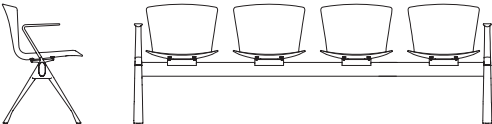

FOUR POSITION, FIVE ARM

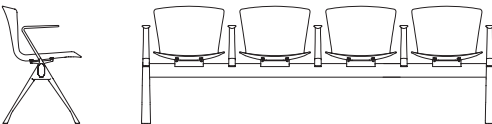

Beam Model

TWO POSITION	CODE
Armless	SB2NA
Two Arm	SB22A
Three Arm	SB23A

THREE POSITION	CODE
Armless	SB3NA
Two Arm	SB32A
Four Arm	SB34A

FOUR POSITION	CODE
Armless	SB4NA
Two Arm	SB42A
Five Arm	SB45A

Beam Finish

DESCRIPTION	CODE
White Textured	WT
Black Textured	BT
Dolphin Textured	DLT
Oxford Textured	OXT
Sterling	ST

Glides

Slam Beam glides are nylon.

Auxiliary Options

DESCRIPTION	CODE
Floor Mount	FM

For a quote on Floor Mount options, please contact Customer Experience.

Freight Note

Due to the size and nature of Slam Beam, the Freight Program does not apply to this product. Please contact Customer Experience for a quote.

Specifications required to create the product code

- Model
- Beam Finish
- Floor Mount (when applicable)



MODEL

Three position,
Armless (SB3NA)

BEAM FINISH

White Textured Powder coat (WT)

FLOOR MOUNT

When applicable, enter Slam Beam
Floor Mount Code (FM)



SLAM BEAM BASE, TWO POSITION
Design: Lievore Altherr Molina, licensed by Sellex

SB10

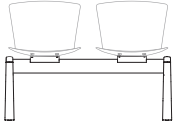

Two Position, Armless			MODEL		LIST PRICE
W 39.25	D 21	H 31	SB2NA	Powder Coat	\$2544

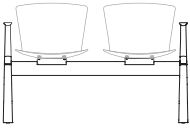

Two Position, Two Arm			MODEL		LIST PRICE
W 43.5	D 21	H 31	SB22A	Powder Coat	\$2717

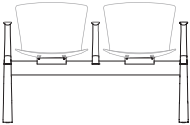

Two Position, Three Arm			MODEL		LIST PRICE
W 43.5	D 21	H 31	SB23A	Powder Coat	\$2891

To specify:
Refer to pages SB6-SB7

SLAM BEAM BASE, THREE POSITION
 Design: Lievore Altherr Molina, licensed by Sellex

SB11

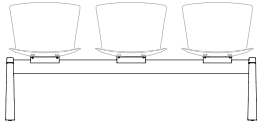

Three Position, Armless			MODEL	LIST PRICE
W 66	D 21	H 31	SB3NA Powder Coat	\$2702

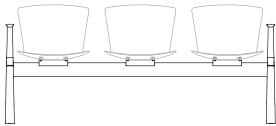

Three Position, Two Arm			MODEL	LIST PRICE
W 70.25	D 21	H 31	SB32A Powder Coat	\$2876

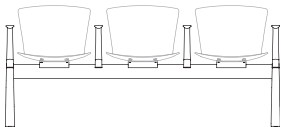

Three Position, Three Arm			MODEL	LIST PRICE
W 70.25	D 21	H 31	SB34A Powder Coat	\$3049

To specify:
 Refer to pages SB6-SB7

SLAM BEAM BASE, FOUR POSITION
 Design: Lievore Altherr Molina, licensed by Sellex

SB12

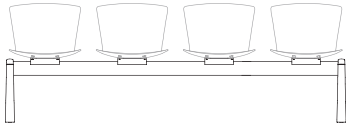

Four Position, Armless			MODEL		LIST PRICE
W 88.5	D 21	H 31	SB4NA	Powder Coat	\$3105

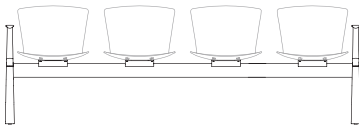

Four Position, Two Arm			MODEL		LIST PRICE
W 93	D 21	H 31	SB42A	Powder Coat	\$3280

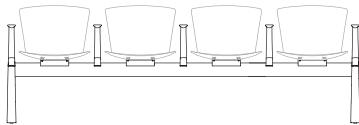

Four Position, Five Arm			MODEL		LIST PRICE
W 93	D 21	H 31	SB45A	Powder Coat	\$3541

To specify:
 Refer to pages SB6-SB7

Shell Selection

DESCRIPTION	CODE
Polypropylene	PO
Polypropylene with Upholstered Seat Onlay	PU
Fully Upholstered	FU
Beech 3D Veneer	3DB
Beech 3D Veneer with Upholstered Seat Onlay	3BU
Oak 3D Veneer	3DO
Oak 3D Veneer with Upholstered Seat Onlay	3OU

Shell Finish

POLYPROPYLENE SHELL:

DESCRIPTION	CODE	DESCRIPTION	CODE
White	W	Dolphin	DL
Black	B	Oxford	OX
Fawn	FW	Blue Sky	BS
Fog	FG	Forest	FO
Pine	PN	Pistachio	PS

BEECH 3D VENEER SHELL:

DESCRIPTION	CODE	DESCRIPTION	CODE
Natural Beech	09M	Neutral	15M
Medium	13M	Classic Mahogany	21M
White Wash II	30M	Espresso	23M
Transparent Black	29M	Graphite	25M
Oxford II	49M	Dolphin II	50M
Blue Sky	100M	Forest	101M
Pistachio	110M		

OAK 3D VENEER SHELL:

DESCRIPTION	CODE
Natural White Oak	12M
Pine	109M
Fog	111M

Shell Upholstery

FULLY UPHOLSTERED SHELL

Please refer to Leland Textile Program which features textiles and leathers from the following partners:

- Camira
- Green Hides
- Carnegie
- Maharam
- CF Stinson
- Unika Vaev

The complete grade list can be found at www.lelandfurniture.com/ecatalog or you can specify COM/COL. Due to the design of this product, it is recommended that all non pre-approved textile be tested for compatibility.

Upholstered Onlay selection

Please refer to Leland Textile Program which features textiles and leathers from the following partners:

- Camira
- Green Hides
- Carnegie
- Maharam
- CF Stinson
- Unika Vaev

The complete grade list can be found at lelandinternational.com/ecatalog or you can specify COM/COL. Due to the design of this product, it is recommended that all non pre-approved textile be tested for compatibility.

Specifications required to create the product code

- Shell Selection
- Shell Finish
- Upholstered Onlay Selection (When Applicable)

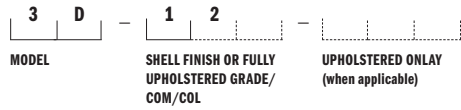

SHELL SELECTION

3D Veneer Shell (3D)

SHELL FINISH

Natural White Oak (12)

UPHOLSTERED ONLAY SELECTION

When applicable, enter upholstery grade, COM or COL

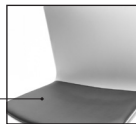

SLAM BEAM SHELL SELECTION
 Design: Lievore Altherr Molina, licensed by Sellex

SB15



Polypropylene	MODEL	LIST PRICE
	PO	\$207



Polypropylene W/ Upholstered Seat Only	MODEL	COM/COL	A	B	C	D	E	F	G	H	I	J	K	L
	PU	\$342	415	450	485	520	555	590	625	660	695	730	765	800

COM Yardage: 1 or 2 seats: .75 yard

Contact Leland Customer Experience for yardage requirements on textiles with repeats.

For COL requirements please contact Leland Customer Experience.



Fully Upholstered	MODEL	COM/COL	A	B	C	D	E	F	G	H	I	J	K	L
	FU	\$486	560	599	638	677	716	755	794	833	872	911	950	989

COM Yardage: 1 or 2 seats: .75 yard

Contact Leland Customer Experience for yardage requirements on textiles with repeats.

For COL requirements please contact Leland Customer Experience.

To specify:
 Refer to pages SB11-SB12



3D Beech Veneer	MODEL	LIST PRICE
	3DB	\$693



3D Beech Veneer W/ Upholstered Seat Only	MODEL	COM/COL	A	B	C	D	E	F	G	H	I	J	K	L
	3BU	\$831	903	938	973	1008	1043	1078	1113	1148	1183	1218	1253	1288

COM Yardage: 1 or 2 seats: .75 yard

Contact Leland Customer Experience for yardage requirements on textiles with repeats.

For COL requirements please contact Leland Customer Experience.



3D Oak Veneer	MODEL	LIST PRICE
	3DO	\$874



3D Oak Veneer W/ Upholstered Seat Only	MODEL	COM/COL	A	B	C	D	E	F	G	H	I	J	K	L
	30U	\$1011	1083	1119	1155	1191	1227	1263	1299	1335	1371	1407	1443	1479

COM Yardage: 1 or 2 seats: .75 yard

Contact Leland Customer Experience for yardage requirements on textiles with repeats.

For COL requirements please contact Leland Customer Experience.

To specify:
 Refer to pages SB11-SB12

Table Model

DESCRIPTION	CODE
Slam table	SBT

Top Finish or Color

LAMINATE TOP:

DESCRIPTION	CODE
Black (Pionite® Suede Black)	LBK
White (WilsonArt® Designer White) LWH Custom	CST

Edge Finish

DESCRIPTION	CODE
Opaque Black	B
Opaque White	W
Natural	11

Specifications required to create the product code

- Table Model
- Top Finish
- Edge Finish



TABLE MODEL

Slam Beam Table (SBT)

TOP FINISH

White Laminate (W)

EDGE FINISH

Opaque White (W)

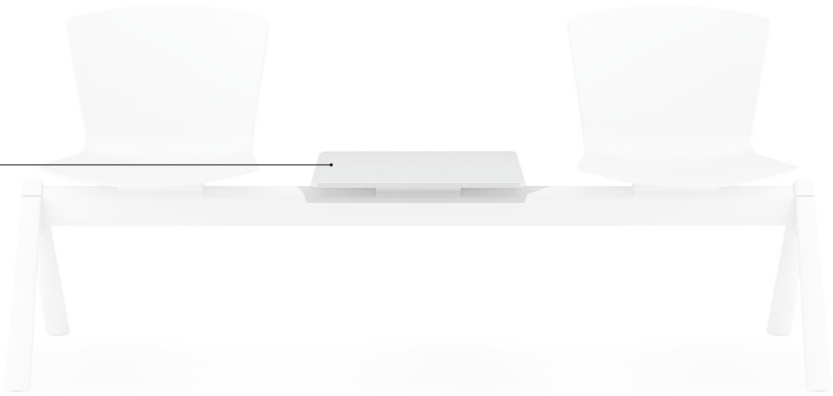

Slame Beam Table	MODEL	FRAME FINISH	LIST PRICE
one base position	SBT	Laminate	\$337
W 22 D 22		Please note that Opaque White and Opaque Black Edge Finishes will have an additional \$20 NET charge.	
TH 17.75 (MOUNTED TO BASE)			



To specify:
Refer to pages SB14-SB15

Slam Beam Floor Mount	MODEL	LIST PRICE
	SBFM	\$219
	Floor mount must be specified at the time of order.	
	Due to the variety of floor surfaces on which Slam Beam may be installed, floor mount fasteners are not supplied by Leland.	
	Responsibility of fastener choice is the customers.	

To specify:
Refer to pages SB14-SB15

5695 Eagle Drive, SE
Grand Rapids,
Michigan 49512
616-975-9260
lelandfurniture.com

Slam

January 2025 Price List



Slam

Table of Contents	SL2
Specification Information	SL3
Specification Example	SL4
Sled Base	SL5
Stacking Four-Leg Base	SL7
Stacking Arm Chair, Four-Leg Base	SL9
Wood Leg Chair	SL11
Stacking Four-Leg Mobile Base	SL13
Side Chair, Aluminum Base	SL15
Arm Chair, Aluminum Base	SL17
Task Base	SL19
Sled Counter Chair	SL21
Four-Leg Counter Chair	SL23
Sled Bar Chair	SL25
Four-Leg Bar Chair	SL27
Stacking/Transport Dolly	SL29
Slam Lounge	SL30

Chair Model

DESCRIPTION	CODE
SLAM sled base	SLS
SLAM stacking 4-leg base	SL4
SLAM stacking arm chair, 4-leg base	SL4A
SLAM stacking 4-leg mobile base	SLM
SLAM side chair, 4-leg aluminum base	SLA
SLAM arm chair, 4-leg aluminum base	SLAA
SLAM task base	SLTB
SLAM side chair, beech wood leg	SLW
SLAM side chair, oak wood leg	SLWO
SLAM sled, counter chair	SLCS
SLAM 4-leg, counter chair	SLC4
SLAM sled, bar chair	SLBS
SLAM 4-leg, bar chair	SLB4
SLAM lounge	SLL

Shell Selection

DESCRIPTION	CODE
Polypropylene	PO
Polypropylene with Upholstered Seat Onlay	PU
Fully Upholstered	FU
3D Beech Veneer	3DB
3D Beech Veneer with Upholstered Seat Onlay	3BU
3D Oak Veneer	3DO
3D Oak Veneer with Upholstered Seat Onlay	3OU

Shell Finish/Color

POLYPROPYLENE SHELL:

DESCRIPTION	CODE	DESCRIPTION	CODE
White	WT	Oxford	OX
Black	BK	Forest	FO
Fawn	FW	Pine	PN
Fog	FG	Pistachio	PS
Blue Sky	BS	Dolphin	DL

CUSTOM POLYPROPYLENE COLORS

Custom color match is available upon request. Please contact hello@lelandfurniture.com for further information

BEECH 3D VENEER SHELL AND/OR WOOD LEG:

DESCRIPTION	CODE	DESCRIPTION	CODE
Natural Beech	09	Graphite	25M
Neutral	15	Oxford II	49M
Medium	13	Dolphin II	50M
Classic Mahogany	21M	Blue Sky	100M
White Wash II	30M	Forest	101M
Espresso	23M	Pistachio	110M
Transparent Black	29M		

OAK 3D VENEER SHELL AND/OR WOOD LEG:

DESCRIPTION	CODE
Natural White Oak	12
Pine	109M
Fog	111M

Frame Finish

DESCRIPTION	CODE	DESCRIPTION	CODE
Black	B	White	W
Warm Grey	WG	Cool Grey	CG
Matte Mercury	MMR	Matte Burnish	MBN
Matte Mineral	MMN	Matte Foundry	MFN
Matte Fawn	MFW	Matte Blue Sky	MBS
Matte Fog	MFG	Matte Pine	MPN
Matte Forest	MFO	Sterling	ST
Matte Pistachio	MPS	Polished Aluminum	P
Chrome	C	*Aluminum models only	

Textured Frame Finishes

DESCRIPTION	CODE	DESCRIPTION	CODE
White Textured	WT	Black Textured	BT
Dolphin Textured	DLT	Oxford Textured	OXT

Glide or Caster Type

STANDARD GLIDES:

DESCRIPTION	CODE
Poly (Sled base)	S
Nylon (4-Leg, Aluminum base)	S
Rubber (Slam Wood Leg)	S

OPTIONAL GLIDES:

DESCRIPTION	CODE
Felt	FC
Floor Saver™ (for VCT type floors) (4-Leg base only)	FS
Metal (4-Leg base only)	M
Rubber (4-Leg base or Aluminum Base only)	R

*Please note that optional glides for four leg models raise the chair height .5 inch.

CASTER TYPE:

(for 4-leg mobile and task base)

DESCRIPTION	CODE
Hard Floor Caster	HF
Soft Floor Caster	SF

Fully Upholstered or Onlay Selection

Please refer to Leland Textile Program which features textiles and leathers from the following partners:

- Camira
- Green Hides
- Carnegie
- Maharam
- CF Stinson
- Unika Vaev

The complete grade list can be found at www.lelandfurniture.com/ecatalog or you can specify COM/COL. Due to the design of this product, it is recommended that all non pre-approved textile be tested for compatibility.

Stacking note

SLAM side chair 4 leg base, stacking arm chair, and 4 leg mobile base are the only models available for stacking.

Specifications required to create the product code

- Model
- Shell Selection
- Shell Finish
- Upholstered Onlay Selection (when applicable)
- Frame Finish
- Glide or Caster Type



MODEL

Slam arm chair, aluminum base (SLAA)

SHELL SELECTION

3D Veneer (3D)

SHELL FINISH

Natural White Oak (12)

UPHOLSTERED ONLAY SELECTION

When applicable, enter upholstery grade, COM



FRAME FINISH

Polished Aluminum (P)

GLIDE OR CASTER TYPE

Standard Nylon (S)



SLAM SLED BASE CHAIR

Design: Lievore Altherr Molina, licensed by Sellex

SL5



Slam Sled Base Chair				MODEL	FRAME FINISH	LIST PRICE
Polypropylene shell				SLS-PO	Powder Coat	\$494
W 22.5	D 20.75	H 31.75	SH 18		Chrome	\$564



Slam Sled Base Chair				MODEL	LIST PRICE/GRADE	COM/COL	A	B	C	D	E	F	G	H	I	J	K	L
Polypropylene shell,				SLS-PU	Powder Coat	\$650	720	757	794	831	868	905	942	979	1016	1053	1090	1127
upholstered seat onlay					Chrome	\$720	792	827	862	897	932	967	1002	1037	1072	1107	1142	1177
W 22.5	D 20.75	H 31.75	SH 18.25	COM Yardage: 1 or 2 seats: .75 yard														

Contact Leland Customer Experience for yardage requirements on textiles with repeats.

For COL requirements please contact Leland Customer Experience.



Slam Sled Base Chair				MODEL	LIST PRICE/GRADE	COM/COL	A	B	C	D	E	F	G	H	I	J	K	L
Fully upholstered				SLS-FU	Powder Coat	\$730	856	919	982	1045	1108	1171	1234	1297	1360	1423	1486	1549
					Chrome	\$800	926	989	1052	1115	1178	1241	1304	1367	1430	1493	1556	1619
W 22.5	D 20.75	H 31.75	SH 18.25	COM Yardage: 1 or 2 seats: .75 yard														

Contact Leland Customer Experience for yardage requirements on textiles with repeats.

For COL requirements please contact Leland Customer Experience.

To specify:

Please refer to pages 3-4 for complete specifying information.

Specify all products by their product code.

Pricing Effective: January 2025

SLAM SLED BASE CHAIR
 Design: Lievore Altherr Molina, licensed by Sellex

SL6



Slam Sled Base Chair				MODEL	FRAME FINISH	LIST PRICE
3D Beech veneer shell				SLS-3DB	Powder Coat	\$1151
W 22.5	D 20.75	H 31.75	SH 18		Chrome	\$1307



Slam Sled Base Chair				MODEL	LIST PRICE/GRADE	COM/COL	A	B	C	D	E	F	G	H	I	J	K	L
3D Beech veneer shell, upholstered seat onlay				SLS-3BU	Powder Coat	\$1307	1379	1415	1451	1487	1523	1559	1595	1631	1667	1703	1739	1775
					Chrome	\$1378	1449	1487	1525	1563	1601	1639	1677	1715	1753	1791	1829	1867

W 22.5 D 20.75 H 31.75 SH 18.25

COM Yardage: 1 or 2 seats: .75 yard

Contact Leland Customer Experience for yardage requirements on textiles with repeats.

Optional Glides: Add \$8.00 net per chair for a seat of four (4).



Slam Sled Base Chair				MODEL	FRAME FINISH	LIST PRICE
3D Oak veneer shell				SLS-3DO	Powder Coat	\$1332
W 22.5	D 20.75	H 31.75	SH 18		Chrome	\$1405



Slam Sled Base Chair				MODEL	LIST PRICE/GRADE	COM/COL	A	B	C	D	E	F	G	H	I	J	K	L
3D Oak veneer shell, upholstered seat onlay				SLS-30U	Powder Coat	\$1490	1560	1597	1634	1671	1708	1745	1782	1819	1856	1893	1930	1967
					Chrome	\$1559	1631	1667	1703	1739	1775	1811	1847	1883	1919	1955	1991	2027

W 22.5 D 20.75 H 31.75 SH 18.25

COM Yardage: 1 or 2 seats: .75 yard

Contact Leland Customer Experience for yardage requirements on textiles with repeats.

Optional Glides: Add \$8.00 net per chair for a seat of four (4).

To specify:
 Please refer to pages 3-4 for complete specifying information.
 Specify all products by their product code.

SLAM 4-LEG BASE CHAIR
 Design: Lievore Altherr Molina, licensed by Sellex

SL7



Slam Stacking

4-Leg Base Chair

	MODEL	FRAME FINISH	LIST PRICE
Polypropylene shell	SL4-PO	Powder Coat	\$497
W 20.75 D 19.75 H 31 SH 18		Chrome	\$568

Optional Glides: Add \$8.00 net per chair for a set of four (4). Optional Glides raise chair height .5 inch.



Slam Stacking

4-Leg Base Chair

	MODEL	LIST PRICE/GRADE	COM/COL	A	B	C	D	E	F	G	H	I	J	K	L
Polypropylene shell, upholstered seat onlay	SL4-PU	Powder Coat	\$677	746	781	816	851	886	921	956	991	1026	1061	1096	1131
		Chrome	\$748	817	852	887	922	957	992	1027	1062	1097	1132	1167	1202

Optional Glides: Add \$8.00 net per chair for a set of four (4). Optional Glides raise chair height .5 inch.

COM Yardage: 1 or 2 seats: .75 yard

Contact Leland Customer Experience for yardage requirements on textiles with repeats.

For COL requirements please contact Leland Customer Experience.



Slam Stacking

4-Leg Base Chair

	MODEL	LIST PRICE/GRADE	COM/COL	A	B	C	D	E	F	G	H	I	J	K	L
Fully upholstered	SL4-FU	Powder Coat	\$754	876	937	998	1059	1120	1181	1242	1303	1364	1425	1486	1547
		Chrome	\$824	946	1007	1068	1129	1190	1251	1312	1373	1434	1495	1556	1617

W 20.75 D 19.75 H 31 SH 18.25

Optional Glides: Add \$8.00 net per chair for a set of four (4). Optional Glides raise chair height .5 inch.

COM Yardage: 1 or 2 seats: .75 yard

Contact Leland Customer Experience for yardage requirements on textiles with repeats.

For COL requirements please contact Leland Customer Experience.

To specify:

Please refer to pages 3-4 for complete specifying information.

Specify all products by their product code.

Pricing Effective: January 2025

SLAM 4-LEG BASE CHAIR
 Design: Lievore Altherr Molina, licensed by Sellex

SL8



**Slam Stacking
 4-Leg Base Chair**

	MODEL	FRAME FINISH	LIST PRICE
3D Beech veneer shell	SL4-3DB	Powder Coat	\$1136
W 20.75 D 19.75 H 31 SH 18		Chrome	\$1207

Optional Glides: Add \$8.00 net per chair for a set of four (4). Optional Glides raise chair height .5 inch.



**Slam Stacking
 4-Leg Base Chair**

	MODEL	LIST PRICE/GRADE	COM/COL	A	B	C	D	E	F	G	H	I	J	K	L
3D Beech veneer shell, upholstered seat onlay	SL4-3BU	Powder Coat	\$1313	1383	1417	1451	1485	1519	1553	1587	1621	1655	1689	1723	1757
		Chrome	\$1386	1456	1491	1526	1561	1596	1631	1666	1701	1736	1771	1806	1841

Optional Glides: Add \$8.00 net per chair for a seat of four (4).

COM Yardage: 1 or 2 seats: .75 yard

Contact Leland Customer Experience for yardage requirements on textiles with repeats.

For COL requirements please contact Leland Customer Experience.



**Slam Stacking
 4-Leg Base Chair**

	MODEL	FRAME FINISH	LIST PRICE
3D Oak veneer shell	SL4-3DO	Powder Coat	\$1313
W 20.75 D 19.75 H 31 SH 18		Chrome	\$1382

Optional Glides: Add \$8.00 net per chair for a seat of four (4).



**Slam Stacking
 4-Leg Base Chair**

	MODEL	LIST PRICE/GRADE	COM/COL	A	B	C	D	E	F	G	H	I	J	K	L
3D Oak veneer shell, upholstered seat onlay	SL4-30U	Powder Coat	\$1491	1560	1595	1630	1665	1700	1735	1770	1805	1840	1875	1910	1945
		Chrome	\$1564	1632	1668	1704	1740	1776	1812	1848	1884	1920	1956	1992	2028

Optional Glides: Add \$8.00 net per chair for a seat of four (4).

COM Yardage: 1 or 2 seats: .75 yard

Contact Leland Customer Experience for yardage requirements on textiles with repeats.

For COL requirements please contact Leland Customer Experience.

To specify:
 Please refer to pages 3-4 for complete specifying information.
 Specify all products by their product code.

Pricing Effective: January 2025

SLAM STACKING ARM CHAIR, 4-LEG BASE
 Design: Lievore Altherr Molina, licensed by Sellex

SL9



Slam Stacking Arm Chair

4-Leg Base

	MODEL	FRAME FINISH	LIST PRICE
Polypropylene shell	SL4A-PO	Powder Coat	\$672
W 25 D 20.75 H 31.75		Chrome with powder coat arm cap	\$745
SH 18 AH 25.5			



Slam Stacking Arm Chair

4-Leg Base

	MODEL	LIST PRICE/GRADE	COM/COL	A	B	C	D	E	F	G	H	I	J	K	L
Polypropylene shell, upholstered seat onlay	SL4A-PU	Powder Coat	\$828	898	935	972	1009	1046	1083	1120	1157	1194	1231	1268	1305
		Chrome with powder coat arm cap	\$900	972	1007	1042	1077	1112	1147	1182	1217	1252	1287	1322	1357
W 25 D 20.75 H 31.75		COM Yardage: 1 or 2 seats: .75 yard													
SH 18.25 AH 25.5		Contact Leland Customer Experience for yardage requirements on textiles with repeats.													



Slam Stacking Arm Chair

4-Leg Base

	MODEL	LIST PRICE/GRADE	COM/COL	A	B	C	D	E	F	G	H	I	J	K	L
Fully upholstered	SL4A-FU	Powder Coat	\$907	1033	1096	1159	1222	1285	1348	1411	1474	1537	1600	1663	1726
		Chrome with powder coat arm cap	\$980	1106	1169	1232	1295	1358	1421	1484	1547	1610	1673	1736	1799
W 25 D 20.75 H 31.75		COM Yardage: 1 seat: 1.5 yards													
SH 18.25 AH 25.5		Contact Leland Customer Experience for yardage requirements on textiles with repeats.													

To specify:

Please refer to pages 3-4 for complete specifying information. Specify all products by their product code.

Pricing Effective: January 2025

SLAM STACKING ARM CHAIR, 4-LEG BASE
 Design: Lievore Altherr Molina, licensed by Sellex

SL10



Slam Stacking Arm Chair

4-Leg Base

	MODEL	FRAME FINISH	LIST PRICE
3D Beech veneer shell	SL4A-3DB	Powder Coat	\$1330
W 25 D 20.75 H 31.75		Chrome with powder coat arm cap	\$1403
SH 18 AH 25.5			



Slam Stacking Arm Chair

4-Leg Base

	MODEL	LIST PRICE/GRADE	COM/COL	A	B	C	D	E	F	G	H	I	J	K	L
3D Beech veneer shell, upholstered seat onlay	SL4A-3BU	Powder Coat	\$1483	1556	1591	1626	1661	1696	1731	1766	1801	1836	1871	1906	1941
		Chrome with powder coat arm cap	\$1559	1631	1667	1703	1739	1775	1811	1847	1883	1919	1955	1991	2027
W 25 D 20.75 H 31.75		Optional Glides: Add \$8.00 net per chair for a seat of four (4).													
SH 18.25 AH 25.5		COM Yardage: 1 or 2 seats: .75 yard													
		Contact Leland Customer Experience for yardage requirements on textiles with repeats.													



Slam Stacking Arm Chair

4-Leg Base

	MODEL	FRAME FINISH	LIST PRICE
3D Oak veneer shell	SL4A-3D0	Powder Coat	\$1512
W 25 D 20.75 H 31.75		Chrome with powder coat arm cap	\$1583
SH 18 AH 25.5			



Slam Stacking Arm Chair

4-Leg Base

	MODEL	LIST PRICE/GRADE	COM/COL	A	B	C	D	E	F	G	H	I	J	K	L
3D Oak veneer shell, upholstered seat onlay	SL4A-30U	Powder Coat	\$1668	1739	1775	1811	1847	1883	1919	1955	1991	2027	2063	2099	2135
		Chrome with powder coat arm cap	\$1742	1812	1849	1886	1923	1960	1997	2034	2071	2108	2145	2182	2219
W 25 D 20.75 H 31.75		Optional Glides: Add \$8.00 net per chair for a seat of four (4).													
SH 18.25 AH 25.5		COM Yardage: 1 or 2 seats: .75 yard													
		Contact Leland Customer Experience for yardage requirements on textiles with repeats.													

To specify:

Please refer to pages 3-4 for complete specifying information. Specify all products by their product code.

Pricing Effective: January 2025

SLAM SIDE CHAIR, BEECH WOOD LEG
 Design: Lievore Altherr Molina, licensed by Sellex

SL11



Slam Side Chair, Beech Wood Leg	MODEL	LIST PRICE
Polypropylene shell, Beech Leg W 22.5 D 21.5 H 31 SH 18	SLW-PO	\$811



Slam Side Chair, Beech Wood Leg	MODEL	COM/COL	A	B	C	D	E	F	G	H	I	J	K	L
Polypropylene shell, Beech Leg upholstered seat onlay W 22.5 D 21.5 H 31 SH 18.25	SLW-PU	\$967	1038	1074	1110	1146	1182	1218	1254	1290	1326	1362	1398	1434
COM Yardage: 1 or 2 seats: .75 yard Contact Leland Customer Experience for yardage requirements on textiles with repeats. For COL requirements please contact Leland Customer Experience.														



Slam Side Chair, Beech Wood Leg	MODEL	COM/COL	A	B	C	D	E	F	G	H	I	J	K	L
Fully upholstered, Beech Leg W 22.5 D 21.5 H 31 SH 18.25	SLW-FU	\$1046	1172	1235	1298	1361	1424	1487	1550	1613	1676	1739	1802	1865
COM Yardage: 1 seat: 1.5 yards Contact Leland Customer Experience for yardage requirements on textiles with repeats. For COL requirements please contact Leland Customer Experience.														

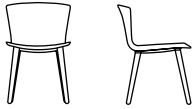

Slam Side Chair, Beech Wood Leg	MODEL	LIST PRICE
3D Beech veneer shell, Beech Leg W 22.5 D 21.5 H 31 SH 18	SLW-3DB	\$1510



Slam Side Chair, Beech Wood Leg	MODEL	COM/COL	A	B	C	D	E	F	G	H	I	J	K	L
3D Beech veneer shell, Beech Leg upholstered seat onlay W 22.5 D 21.5 H 31 SH 18.25	SLW-3BU	\$1709	1779	1816	1853	1890	1927	1964	2001	2038	2075	2112	2149	2186
COM Yardage: 1 or 2 seats: .75 yard Contact Leland Customer Experience for yardage requirements on textiles with repeats. For COL requirements please contact Leland Customer Experience.														

To specify:
 Please refer to pages 3-4 for complete specifying information.
 Specify all products by their product code.

SLAM SIDE CHAIR, OAK WOOD LEG
 Design: Lievore Altherr Molina, licensed by Sellex

SL12



Slam Side Chair, Oak Wood Leg	MODEL	LIST PRICE
Polypropylene shell, Oak Leg W 22.5 D 21.5 H 31 SH 18	SLWO-PO	\$911



Slam Side Chair, Oak Wood Leg	MODEL	COM/COL	A	B	C	D	E	F	G	H	I	J	K	L
Polypropylene shell, Oak Leg upholstered seat only W 22.5 D 21.5 H 31 SH 18.25	SLWO-PU	\$1067	1138	1174	1210	1246	1282	1318	1354	1390	1426	1462	1498	1534
COM Yardage: 1 or 2 seats: .75 yard Contact Leland Customer Experience for yardage requirements on textiles with repeats. For COL requirements please contact Leland Customer Experience.														



Slam Side Chair, Oak Wood Leg	MODEL	COM/COL	A	B	C	D	E	F	G	H	I	J	K	L
Fully upholstered, Oak Leg W 22.5 D 21.5 H 31 SH 18.25	SLWO-FU	\$1146	1272	1334	1396	1458	1520	1582	1644	1706	1768	1830	1892	1954
COM Yardage: 1 seat: 1.5 yards Contact Leland Customer Experience for yardage requirements on textiles with repeats. For COL requirements please contact Leland Customer Experience.														



Slam Side Chair, Oak Wood Leg	MODEL	LIST PRICE
3D Oak veneer shell, Oak Leg W 22.5 D 21.5 H 31 SH 18	SLWO-3DO	\$1852



Slam Side Chair, Oak Wood Leg	MODEL	COM/COL	A	B	C	D	E	F	G	H	I	J	K	L
3D Oak veneer shell, Oak Leg upholstered seat only W 22.5 D 21.5 H 31 SH 18.25	SLWO-3OU	\$2080	2161	2203	2245	2287	2329	2371	2413	2455	2497	2539	2581	2623
COM Yardage: 1 or 2 seats: .75 yard Contact Leland Customer Experience for yardage requirements on textiles with repeats. For COL requirements please contact Leland Customer Experience.														

To specify:
 Please refer to pages 3-4 for complete specifying information.
 Specify all products by their product code.

SLAM STACKING 4-LEG MOBILE BASE CHAIR
 Design: Lievore Altherr Molina, licensed by Sellex

SL13



Slam Stacking

4-Leg Mobile Base Chair

	MODEL	FRAME FINISH	LIST PRICE
Polypropylene shell w/ casters W 20.75 D 19.75 H 31.75 SH 18.25	SLM-PO	Powder Coat	\$810
		Chrome	\$881



Slam Stacking

4-Leg Mobile Base Chair

	MODEL	LIST PRICE/GRADE	COM/COL	A	B	C	D	E	F	G	H	I	J	K	L
Polypropylene shell, upholstered seat onlay, w/ casters W 20.75 D 19.75 H 31.75 SH 18.5	SLM-PU	Powder Coat	\$998	1068	1105	1142	1179	1216	1253	1290	1327	1364	1401	1438	1475
		Chrome	\$1066	1137	1173	1209	1245	1281	1317	1353	1389	1425	1461	1497	1533

COM Yardage: 1 or 2 seats: .75 yard
 Contact Leland Customer Experience for yardage requirements on textiles with repeats.
 For COL requirements please contact Leland Customer Experience.



Slam Stacking

4-Leg Mobile Base Chair

	MODEL	LIST PRICE/GRADE	COM/COL	A	B	C	D	E	F	G	H	I	J	K	L
Fully upholstered w/ casters W 20.75 D 19.75 H 31.75 SH 18.25	SLM-FU	Powder Coat	\$1074	1200	1262	1324	1386	1448	1510	1572	1634	1696	1758	1820	1882
		Chrome	\$1145	1271	1333	1395	1457	1519	1581	1643	1705	1767	1829	1891	1953

COM Yardage: 1 or 2 seats: .75 yard
 Contact Leland Customer Experience for yardage requirements on textiles with repeats.
 For COL requirements please contact Leland Customer Experience.

To specify:

Please refer to pages 3-4 for complete specifying information. Specify all products by their product code.

Pricing Effective: January 2025

SLAM STACKING 4-LEG MOBILE BASE CHAIR
 Design: Lievore Altherr Molina, licensed by Sellex

SL14



Slam Stacking

4-Leg Mobile Base Chair

	MODEL	FRAME FINISH	LIST PRICE
3D Beech veneer shell, w/ casters	SLM-3DB	Powder Coat	\$1468
		Chrome	\$1540

W 20.75 D 19.75 H 31.75
SH 18.25



Slam Stacking

4-Leg Mobile Base Chair

	MODEL	LIST PRICE/GRADE	COM/COL	A	B	C	D	E	F	G	H	I	J	K	L
3D Beech veneer shell, upholstered seat onlay, w/ casters	SLM-3BU	Powder Coat	\$1653	1724	1760	1796	1832	1868	1904	1940	1976	2012	2048	2084	2120
		Chrome	\$1724	1795	1832	1869	1906	1943	1980	2017	2054	2091	2128	2165	2202

COM Yardage: 1 or 2 seats: .75 yard
 Contact Leland Customer Experience for yardage requirements on textiles with repeats.
 For COL requirements please contact Leland Customer Experience.

W 20.75 D 19.75 H 31.75
SH 18.5



Slam Stacking

4-Leg Mobile Base Chair

	MODEL	FRAME FINISH	LIST PRICE
3D Oak veneer shell, w/ casters	SLM-3DO	Powder Coat	\$1650
		Chrome	\$1722

W 20.75 D 19.75 H 31.75
SH 18.25



Slam Stacking

4-Leg Mobile Base Chair

	MODEL	LIST PRICE/GRADE	COM/COL	A	B	C	D	E	F	G	H	I	J	K	L
3D Oak veneer shell, upholstered seat onlay, w/ casters	SLM-3OU	Powder Coat	\$1835	1906	1943	1980	2017	2054	2091	2128	2165	2202	2239	2276	2313
		Chrome	\$1907	1980	2015	2050	2085	2120	2155	2190	2225	2260	2295	2330	2365

COM Yardage: 1 or 2 seats: .75 yard
 Contact Leland Customer Experience for yardage requirements on textiles with repeats.
 For COL requirements please contact Leland Customer Experience.z

W 20.75 D 19.75 H 31.75
SH 18.5

To specify:

Please refer to pages 3-4 for complete specifying information. Specify all products by their product code.

SLAM STACKING MOBILE ARM CHAIR
 Design: Lievore Altherr Molina, licensed by Sellex

SL15



Slam Stacking

4-Leg Mobile Base Chair

	MODEL	FRAME FINISH	LIST PRICE
Polypropylene shell w/ casters	SLMA-PO	Powder Coat	\$969
W 20.75 D 19.75 H 31.75			
SH 18.25			



Slam Stacking

4-Leg Mobile Base Chair

	MODEL	LIST PRICE/GRADE	COM/COL	A	B	C	D	E	F	G	H	I	J	K	L
Polypropylene shell, upholstered seat onlay, w/ casters	SLMA-PU	Powder Coat	\$1157	1227	1264	1301	1338	1375	1412	1449	1486	1523	1560	1597	1634
W 20.75 D 19.75 H 31.75															
SH 18.5															

COM Yardage: 1 or 2 seats: .75 yard
 Contact Leland Customer Experience for yardage requirements on textiles with repeats.
 For COL requirements please contact Leland Customer Experience.



Slam Stacking

4-Leg Mobile Base Chair

	MODEL	LIST PRICE/GRADE	COM/COL	A	B	C	D	E	F	G	H	I	J	K	L
Fully upholstered w/ casters	SLMA-FU	Powder Coat	\$1233	1359	1422	1485	1548	1611	1674	1737	1800	1863	1926	1989	2052
W 20.75 D 19.75 H 31.75															
SH 18.25															

COM Yardage: 1 or 2 seats: .75 yard
 Contact Leland Customer Experience for yardage requirements on textiles with repeats.
 For COL requirements please contact Leland Customer Experience.

To specify:
 Please refer to pages 3-4 for complete specifying information.
 Specify all products by their product code.

Pricing Effective: January 2025

SLAM STACKING MOBILE ARM CHAIR
 Design: Lievore Altherr Molina, licensed by Sellex

SL16



Slam Stacking

4-Leg Mobile Base Chair

	MODEL	FRAME FINISH	LIST PRICE
3D Beech veneer shell, w/ casters W 20.75 D 19.75 H 31.75 SH 18.25	SLMA-3DB	Powder Coat	\$1626



Slam Stacking

4-Leg Mobile Base Chair

	MODEL	LIST PRICE/GRADE	COM/COL	A	B	C	D	E	F	G	H	I	J	K	L
3D Beech veneer shell, upholstered seat onlay, w/ casters W 20.75 D 19.75 H 31.75 SH 18.5	SLMA-3BU	Powder Coat	\$1813	1884	1920	1956	1992	2028	2064	2100	2136	2172	2208	2244	2280
			COM Yardage: 1 or 2 seats: .75 yard												
			Contact Leland Customer Experience for yardage requirements on textiles with repeats.												
			For COL requirements please contact Leland Customer Experience.												



Slam Stacking

4-Leg Mobile Base Chair

	MODEL	FRAME FINISH	LIST PRICE
3D Oak veneer shell, w/ casters W 20.75 D 19.75 H 31.75 SH 18.25	SLMA-3D0	Powder Coat	\$1810



Slam Stacking

4-Leg Mobile Base Chair

	MODEL	LIST PRICE/GRADE	COM/COL	A	B	C	D	E	F	G	H	I	J	K	L
3D Oak veneer shell, upholstered seat onlay, w/ casters W 20.75 D 19.75 H 31.75 SH 18.5	SLMA-30U	Powder Coat	\$1995	2066	2102	2138	2174	2210	2246	2282	2318	2354	2390	2426	2462
			COM Yardage: 1 or 2 seats: .75 yard												
			Contact Leland Customer Experience for yardage requirements on textiles with repeats.												
			For COL requirements please contact Leland Customer Experience.												

To specify:

Please refer to pages 3-4 for complete specifying information. Specify all products by their product code.

Pricing Effective: January 2025

SLAM SIDE CHAIR, ALUMINUM BASE
 Design: Lievore Altherr Molina, licensed by Sellex

SL17



Slam Side Chair
Aluminum Base

	MODEL	FRAME FINISH	LIST PRICE
Polypropylene shell	SLA-PO	Powder Coat	\$833
W 20.75 D 20.75		Polished Aluminum	\$1467
H 31.75 SH 18		Optional Glides: Add \$8.00 net per chair for a set of four (4). Optional Glides raise chair height .5 inch.	



Slam Side Chair
Aluminum Base

	MODEL	LIST PRICE/GRADE	COM/COL	A	B	C	D	E	F	G	H	I	J	K	L
Polypropylene shell, upholstered seat onlay	SLA-PU	Powder Coat	\$990	1063	1099	1135	1171	1207	1243	1279	1315	1351	1387	1423	1459
W 20.75 D 20.75		Polished Aluminum	\$1623	1694	1731	1768	1805	1842	1879	1916	1953	1990	2027	2064	2101
H 31.75 SH 18.25		Optional Glides: Add \$8.00 net per chair for a set of four (4). Optional Glides raise chair height .5 inch.													
		COM Yardage: 1 or 2 seats: .75 yard													
		Contact Leland Customer Experience for yardage requirements on textiles with repeats.													



Slam Side Chair
Aluminum Base

	MODEL	LIST PRICE/GRADE	COM/COL	A	B	C	D	E	F	G	H	I	J	K	L
Fully upholstered	SLA-FU	Powder Coat	\$1069	1194	1257	1320	1383	1446	1509	1572	1635	1698	1761	1824	1887
W 20.75 D 20.75		Polished Aluminum	\$1703	1828	1891	1954	2017	2080	2143	2206	2269	2332	2395	2458	2521
H 31.75 SH 18.25		COM Yardage: 1 seat: 1.5 yards													
		Contact Leland Customer Experience for yardage requirements on textiles with repeats.													

To specify:
 Please refer to pages 3-4 for complete specifying information.
 Specify all products by their product code.

SLAM SIDE CHAIR, ALUMINUM BASE
 Design: Lievore Altherr Molina, licensed by Sellex

SL18



Slam Side Chair

Aluminum Base

	MODEL	FRAME FINISH	LIST PRICE
3D Beech veneer shell, aluminum base	SLA-3DB	Powder Coat	\$1495
		Polished Aluminum	\$2125
W 20.75 D 20.75			
H 31.75 SH 18			



Slam Side Chair

Aluminum Base

	MODEL	LIST PRICE/GRADE	COM/COL	A	B	C	D	E	F	G	H	I	J	K	L
3D Beech veneer shell, upholstered seat onlay, aluminum base	SLA-3BU	Powder Coat	\$1649	1720	1756	1792	1828	1864	1900	1936	1972	2008	2044	2080	2116
		Polished Aluminum	\$2280	2353	2388	2423	2458	2493	2528	2563	2598	2633	2668	2703	2738
W 20.75		D 20.75		Optional Glides: Add \$8.00 net per chair for a seat of four (4).											
H 31.75		SH 18.25		COM Yardage: 1 or 2 seats: .75 yard											
Contact Leland Customer Experience for yardage requirements on textiles with repeats.															



Slam Side Chair

Aluminum Base

	MODEL	FRAME FINISH	LIST PRICE
3D Oak veneer shell	SLA-3DO	Powder Coat	\$1676
		Polished Aluminum	\$2307
W 20.75 D 20.75			
H 31.75 SH 18			



Slam Side Chair

Aluminum Base

	MODEL	LIST PRICE/GRADE	COM/COL	A	B	C	D	E	F	G	H	I	J	K	L
3D Oak veneer shell, upholstered seat onlay, aluminum base	SLA-30U	Powder Coat	\$1829	1900	1936	1972	2008	2044	2080	2116	2152	2188	2224	2260	2296
		Polished Aluminum	\$2463	2534	2569	2604	2639	2674	2709	2744	2779	2814	2849	2884	2919
W 20.75		D 20.75		Optional Glides: Add \$8.00 net per chair for a seat of four (4).											
H 31.75		SH 18.25		COM Yardage: 1 or 2 seats: .75 yard											
Contact Leland Customer Experience for yardage requirements on textiles with repeats.															

To specify:

Please refer to pages 3-4 for complete specifying information. Specify all products by their product code.

SLAM ARM CHAIR, ALUMINUM BASE
 Design: Lievore Altherr Molina, licensed by Sellex

SL19



Slam Arm Chair
Aluminum Base

	MODEL	FRAME FINISH	LIST PRICE
Polypropylene shell	SLAA-PO	Powder Coat	\$933
W 25 D 20.75 H 31.75		Polished Aluminum	\$1620
SH 18 AH 25.5			



Slam Arm Chair
Aluminum Base

	MODEL	LIST PRICE/GRADE	COM/COL	A	B	C	D	E	F	G	H	I	J	K	L
Polypropylene shell, upholstered seat onlay	SLAA-PU	Powder Coat	\$1089	1160	1196	1232	1268	1304	1340	1376	1412	1448	1484	1520	1556
		Polished Aluminum	\$1775	1845	1882	1919	1956	1993	2030	2067	2104	2141	2178	2215	2252
W 25 D 20.75 H 31.75		COM Yardage: 1 or 2 seats: .75 yard													
SH 18.25 AH 25.5		Contact Leland Customer Experience for yardage requirements on textiles with repeats.													



Slam Arm Chair
Aluminum Base

	MODEL	LIST PRICE/GRADE	COM/COL	A	B	C	D	E	F	G	H	I	J	K	L
Fully upholstered	SLAA-FU	Powder Coat	\$1169	1294	1357	1420	1483	1546	1609	1672	1735	1798	1861	1924	1987
W 25 D 20.75 H 31.75		Polished Aluminum	\$1856	1982	2044	2106	2168	2230	2292	2354	2416	2478	2540	2602	2664
SH 18.25 AH 25.5		COM Yardage: 1 seat: 1.5 yards													
		Contact Leland Customer Experience for yardage requirements on textiles with repeats.													

To specify:
 Please refer to pages 3-4 for complete specifying information.
 Specify all products by their product code.

SLAM ARM CHAIR, ALUMINUM BASE
 Design: Lievore Altherr Molina, licensed by Sellex

SL20



Slam Arm Chair

Aluminum Base

	MODEL	FRAME FINISH	LIST PRICE
3D Beech veneer shell	SLAA-3DB	Powder Coat	\$1589
W 25 D 20.75 H 31.75		Polished Aluminum	\$2276
SH 18 AH 25.5			



Slam Arm Chair

Aluminum Base

	MODEL	LIST PRICE/GRADE	COM/COL	A	B	C	D	E	F	G	H	I	J	K	L
3D Beech veneer shell,	SLAA-3BU	Powder Coat	\$1746	1818	1853	1888	1923	1958	1993	2028	2063	2098	2133	2168	2203
upholstered seat onlay, aluminum base		Polished Aluminum	\$2432	2502	2539	2576	2613	2650	2687	2724	2761	2798	2835	2872	2909
W 25 D 20.75 H 31.75		Optional Glides: Add \$8.00 net per chair for a seat of four (4).													
SH 18.25 AH 25.5		COM Yardage: 1 or 2 seats: .75 yard													
		Contact Leland Customer Experience for yardage requirements on textiles with repeats.													



Slam Arm Chair

Aluminum Base

	MODEL	FRAME FINISH	LIST PRICE
3D Oak veneer shell, aluminum base	SLAA-3D0	Powder Coat	\$1774
W 25 D 20.75 H 31.75		Polished Aluminum	\$2456
SH 18 AH 25.5			



Slam Arm Chair

Aluminum Base

	MODEL	LIST PRICE/GRADE	COM/COL	A	B	C	D	E	F	G	H	I	J	K	L
3D Oak veneer shell,	SLAA-30U	Powder Coat	\$1928	1999	2036	2073	2110	2147	2184	2221	2258	2295	2332	2369	2406
upholstered seat onlay,		Polished Aluminum	\$2612	2684	2721	2758	2795	2832	2869	2906	2943	2980	3017	3054	3091
aluminum base		Optional Glides: Add \$8.00 net per chair for a seat of four (4).													
W 25 D 20.75 H 31.75		COM Yardage: 1 or 2 seats: .75 yard													
SH 18.25 AH 25.5		Contact Leland Customer Experience for yardage requirements on textiles with repeats.													

To specify:

Please refer to pages 3-4 for complete specifying information. Specify all products by their product code.

SLAM TASK BASE CHAIR
 Design: Lievore Altherr Molina, licensed by Sellex

SL21

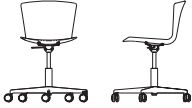

Slam Task Base Chair	MODEL	FRAME FINISH	LIST PRICE
Polypropylene shell	SLTB-PO	Powder Coat	\$939
W 20.75 D 20.75			
H 31.75-35.75 SH 18.25-22.5			



Slam Task Base Chair	MODEL	LIST PRICE/GRADE	COM/COL	A	B	C	D	E	F	G	H	I	J	K	L
Polypropylene shell, upholstered seat onlay	SLTB-PU	Powder Coat	\$1094	1140	1161	1182	1203	1224	1245	1266	1287	1308	1329	1350	1371
W 20.75 D 20.75															
H 31.75-35.75 SH 18.25-22.5															

COM Yardage: 1 or 2 seats: .75 yard
 Contact Leland Customer Experience for yardage requirements on textiles with repeats.

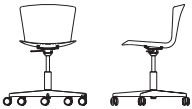

Slam Task Base Chair	MODEL	LIST PRICE/GRADE	COM/COL	A	B	C	D	E	F	G	H	I	J	K	L
Fully upholstered	SLTB-FU	Powder Coat	\$1175	1300	1363	1426	1489	1552	1615	1678	1741	1804	1867	1930	1993
W 20.75 D 20.75															
H 31.75-35.75 SH 18.25-22.5															

COM Yardage: 1 seat: 1.5 yards
 Contact Leland Customer Experience for yardage requirements on textiles with repeats.

To specify:
 Please refer to pages 3-4 for complete specifying information.
 Specify all products by their product code.

SLAM TASK BASE CHAIR
 Design: Lievore Altherr Molina, licensed by Sellex

SL22

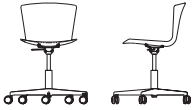

Slam Task Base Chair	MODEL	FRAME FINISH	LIST PRICE
3D Beech veneer shell	SLTB-3DB	Powder Coat	\$1598
W 20.75 D 20.75			
H 31.75-35.75 SH 18.25-22.5			

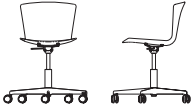

Slam Task Base Chair	MODEL	LIST PRICE/GRADE	COM/COL	A	B	C	D	E	F	G	H	I	J	K	L
3D Beech veneer shell, upholstered seat onlay	SLTB-3BU	Powder Coat	\$1755	1799	1821	1843	1865	1887	1909	1931	1953	1975	1997	2019	2041
W 20.75 D 20.75															
H 31.75-35.75 SH 18.25-22.5															
			COM Yardage: 1 or 2 seats: .75 yard												
			Contact Leland Customer Experience for yardage requirements on textiles with repeats.												

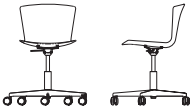

Slam Task Base Chair	MODEL	FRAME FINISH	LIST PRICE
3D Oak veneer shell	SLTB-3DO	Powder Coat	\$1778
W 20.75 D 20.75			
H 31.75-35.75 SH 18.25-22.5			



Slam Task Base Chair	MODEL	LIST PRICE/GRADE	COM/COL	A	B	C	D	E	F	G	H	I	J	K	L
3D Oak veneer shell, upholstered seat onlay	SLTB-3OU	Powder Coat	\$1935	1980	2002	2024	2046	2068	2090	2112	2134	2156	2178	2200	2222
W 20.75 D 20.75															
H 31.75-35.75 SH 18.25-22.5															
			COM Yardage: 1 or 2 seats: .75 yard												
			Contact Leland Customer Experience for yardage requirements on textiles with repeats.												

To specify:
 Please refer to pages 3-4 for complete specifying information.
 Specify all products by their product code.

Pricing Effective: January 2025

SLAM SLED COUNTER CHAIR
 Design: Lievore Altherr Molina, licensed by Sellex

SL23



Slam Sled Counter Chair

	MODEL	FRAME FINISH	LIST PRICE
Polypropylene shell	SLCS-PO	Powder Coat	\$751
W 22 D 20.75 H 39 SH 25		Chrome	\$833

Optional Glides: Add \$8.00 net per chair for a set of four (4). Optional Glides raise chair height .5 inch.



Slam Sled Counter Chair

	MODEL	LIST PRICE/GRADE	COM/COL	A	B	C	D	E	F	G	H	I	J	K	L
Polypropylene shell, upholstered seat onlay	SLCS-PU	Powder Coat	\$908	979	1015	1051	1087	1123	1159	1195	1231	1267	1303	1339	1375
		Chrome	\$990	1063	1099	1135	1171	1207	1243	1279	1315	1351	1387	1423	1459

W 22 D 20.75
 H 39 SH 25.25

COM Yardage: 1 or 2 seats: .75 yard
 Contact Leland Customer Experience for yardage requirements on textiles with repeats.
 Optional Glides: Add \$8.00 net per chair for a set of four (4). Optional Glides raise chair height .5 inch.



Slam Sled Counter Chair

	MODEL	LIST PRICE/GRADE	COM/COL	A	B	C	D	E	F	G	H	I	J	K	L
Fully upholstered	SLCS-FU	Powder Coat	\$986	1112	1175	1238	1301	1364	1427	1490	1553	1616	1679	1742	1805
W 22 D 20.75		Chrome	\$1069	1194	1257	1320	1383	1446	1509	1572	1635	1698	1761	1824	1887

H 39 SH 25.25

COM Yardage: 1 seat: 1.5 yards
 Contact Leland Customer Experience for yardage requirements on textiles with repeats.
 Optional Glides: Add \$8.00 net per chair for a set of four (4). Optional Glides raise chair height .5 inch.

To specify:
 Please refer to pages 3-4 for complete specifying information.
 Specify all products by their product code.

SLAM SLED COUNTER CHAIR
 Design: Lievore Altherr Molina, licensed by Sellex

SL24



Slam Sled Counter Chair

	MODEL	FRAME FINISH	LIST PRICE
3D Beech veneer shell	SLCS-3DB	Powder Coat	\$1409
W 22 D 20.75 H 39 SH 25		Chrome	\$1495

Optional Glides: Add \$8.00 net per chair for a set of four (4). Optional Glides raise chair height .5 inch.



Slam Sled Counter Chair

	MODEL	LIST PRICE/GRADE	COM/COL	A	B	C	D	E	F	G	H	I	J	K	L
3D Beech veneer shell, upholstered seat onlay	SLCS-3BU	Powder Coat	\$1563	1634	1670	1706	1742	1778	1814	1850	1886	1922	1958	1994	2030
		Chrome	\$1649	1720	1756	1792	1828	1864	1900	1936	1972	2008	2044	2080	2116

COM Yardage: 1 or 2 seats: .75 yard

Contact Leland Customer Experience for yardage requirements on textiles with repeats.

Optional Glides: Add \$8.00 net per chair for a set of four (4). Optional Glides raise chair height .5 inch.



Slam Sled Counter Chair

	MODEL	FRAME FINISH	LIST PRICE
3D Oak veneer shell	SLCS-3D0	Powder Coat	\$1589
W 22 D 20.75 H 39 SH 25		Chrome	\$1676

Optional Glides: Add \$8.00 net per chair for a seat of four (4).



Slam Sled Counter Chair

	MODEL	LIST PRICE/GRADE	COM/COL	A	B	C	D	E	F	G	H	I	J	K	L
3D Oak veneer shell, upholstered seat onlay	SLCS-30U	Powder Coat	\$1744	1816	1851	1886	1921	1956	1991	2026	2061	2096	2131	2166	2201
		Chrome	\$1829	1900	1936	1972	2008	2044	2080	2116	2152	2188	2224	2260	2296

COM Yardage: 1 or 2 seats: .75 yard

Contact Leland Customer Experience for yardage requirements on textiles with repeats.

Optional Glides: Add \$8.00 net per chair for a set of four (4). Optional Glides raise chair height .5 inch.

To specify:
 Please refer to pages 3-4 for complete specifying information.
 Specify all products by their product code.

SLAM 4-LEG COUNTER CHAIR
 Design: Lievore Altherr Molina, licensed by Sellex

SL25



Slam 4-Leg Counter Chair

	MODEL	FRAME FINISH	LIST PRICE
Polypropylene shell	SLC4-PO	Powder Coat	\$981
W 22 D 19.75 H 37 SH 25		Chrome	\$1061

Optional Glides: Add \$8.00 net per chair for a set of four (4). Optional Glides raise chair height .5 inch.



Slam 4-Leg Counter Chair

	MODEL	LIST PRICE/GRADE	COM/COL	A	B	C	D	E	F	G	H	I	J	K	L
Polypropylene shell, upholstered seat onlay	SLC4-PU	Powder Coat	\$1135	1207	1243	1279	1315	1351	1387	1423	1459	1495	1531	1567	1603
		Chrome	\$1218	1288	1325	1362	1399	1436	1473	1510	1547	1584	1621	1658	1695

Optional Glides: Add \$8.00 net per chair for a set of four (4). Optional Glides raise chair height .5 inch.

COM Yardage: 1 or 2 seats: .75 yard

Contact Leland Customer Experience for yardage requirements on textiles with repeats.

For COL requirements please contact Leland Customer Experience.



Slam 4-Leg Counter Chair

	MODEL	LIST PRICE/GRADE	COM/COL	A	B	C	D	E	F	G	H	I	J	K	L
Fully upholstered	SLC4-FU	Powder Coat	\$1216	1342	1404	1466	1528	1590	1652	1714	1776	1838	1900	1962	2024
		Chrome	\$1297	1423	1486	1549	1612	1675	1738	1801	1864	1927	1990	2053	2116

Optional Glides: Add \$8.00 net per chair for a set of four (4). Optional Glides raise chair height .5 inch.

COM Yardage: 1 or 2 seats: .75 yard

Contact Leland Customer Experience for yardage requirements on textiles with repeats.

For COL requirements please contact Leland Customer Experience.

To specify:
 Please refer to pages 3-4 for complete specifying information.
 Specify all products by their product code.

Pricing Effective: January 2025

SLAM 4-LEG COUNTER CHAIR
 Design: Lievore Altherr Molina, licensed by Sellex

SL26



Slam 4-Leg Counter Chair

	MODEL	FRAME FINISH	LIST PRICE
3D Beech veneer shell	SLC4-3DB	Powder Coat	\$1639
W 22 D 19.75 H 37 SH 25		Chrome	\$1719

Optional Glides: Add \$8.00 net per chair for a set of four (4). Optional Glides raise chair height .5 inch.



Slam 4-Leg Counter Chair

	MODEL	LIST PRICE/GRADE	COM/COL	A	B	C	D	E	F	G	H	I	J	K	L
3D Beech veneer shell, upholstered seat onlay	SLC4-3BU	Powder Coat	\$1792	1864	1899	1934	1969	2004	2039	2074	2109	2144	2179	2214	2249
		Chrome	\$1874	1947	1983	2019	2055	2091	2127	2163	2199	2235	2271	2307	2343

Optional Glides: Add \$8.00 net per chair for a seat of four (4).

COM Yardage: 1 or 2 seats: .75 yard

Contact Leland Customer Experience for yardage requirements on textiles with repeats.

For COL requirements please contact Leland Customer Experience.



Slam 4-Leg Counter Chair

	MODEL	FRAME FINISH	LIST PRICE
3D Oak veneer shell	SLC4-3D0	Powder Coat	\$1820
W 22 D 19.75 H 37 SH 25		Chrome	\$1900

Optional Glides: Add \$8.00 net per chair for a seat of four (4).



Slam 4-Leg Counter Chair

	MODEL	LIST PRICE/GRADE	COM/COL	A	B	C	D	E	F	G	H	I	J	K	L
3D Oak veneer shell, upholstered seat onlay	SLC4-30U	Powder Coat	\$1975	2045	2082	2119	2156	2193	2230	2267	2304	2341	2378	2415	2452
		Chrome	\$2058	2129	2165	2201	2237	2273	2309	2345	2381	2417	2453	2489	2525

Optional Glides: Add \$8.00 net per chair for a seat of four (4).

COM Yardage: 1 or 2 seats: .75 yard

Contact Leland Customer Experience for yardage requirements on textiles with repeats.

For COL requirements please contact Leland Customer Experience.

To specify:

Please refer to pages 3-4 for complete specifying information. Specify all products by their product code.

SLAM SLED BAR CHAIR
 Design: Lievore Altherr Molina, licensed by Sellex

SL27



Slam Sled Bar Chair		MODEL	FRAME FINISH	LIST PRICE
Polypropylene shell		SLBS-PO	Powder Coat	\$845
W 22	D 20.75		Chrome	\$918
H 43	SH 30	Optional Glides: Add \$8.00 net per chair for a set of four (4). Optional Glides raise chair height .5 inch.		



Slam Sled Bar Chair		MODEL	LIST PRICE/GRADE	COM/COL	A	B	C	D	E	F	G	H	I	J	K	L
Polypropylene shell, upholstered seat onlay		SLBS-PU	Powder Coat	\$939	1012	1047	1082	1117	1152	1187	1222	1257	1292	1327	1362	1397
			Chrome	\$1011	1083	1119	1155	1191	1227	1263	1299	1335	1371	1407	1443	1479
W 22	D 20.75	COM Yardage: 1 or 2 seats: .75 yard														
H 43	SH 30.25	Contact Leland Customer Experience for yardage requirements on textiles with repeats.														
Optional Glides: Add \$8.00 net per chair for a set of four (4). Optional Glides raise chair height .5 inch.																



Slam Sled Bar Chair		MODEL	LIST PRICE/GRADE	COM/COL	A	B	C	D	E	F	G	H	I	J	K	L
Fully upholstered		SLBS-FU	Powder Coat	\$1080	1206	1269	1332	1395	1458	1521	1584	1647	1710	1773	1836	1899
W 22	D 20.75		Chrome	\$1154	1280	1343	1406	1469	1532	1595	1658	1721	1784	1847	1910	1973
H 43	SH 30.25	COM Yardage: 1 seat: 1.5 yards														
Contact Leland Customer Experience for yardage requirements on textiles with repeats.																
Optional Glides: Add \$8.00 net per chair for a set of four (4). Optional Glides raise chair height .5 inch.																

To specify:
 Please refer to pages 3-4 for complete specifying information.
 Specify all products by their product code.

SLAM SLED BAR CHAIR
 Design: Lievore Altherr Molina, licensed by Sellex

SL28



Slam Sled Bar Chair		MODEL	FRAME FINISH	LIST PRICE
3D Beech veneer shell		SLBS-3DB	Powder Coat	\$1503
W 22	D 20.75		Chrome	\$1578
H 43	SH 30		Optional Glides: Add \$8.00 net per chair for a set of four (4). Optional Glides raise chair height .5 inch.	



Slam Sled Bar Chair		MODEL	LIST PRICE/GRADE	COM/COL	A	B	C	D	E	F	G	H	I	J	K	L
3D Beech veneer shell, upholstered seat onlay		SLBS-3BU	Powder Coat	\$1658	1729	1766	1803	1840	1877	1914	1951	1988	2025	2062	2099	2136
			Chrome	\$1853	1924	1960	1996	2032	2068	2104	2140	2176	2212	2248	2284	2320
W 22	D 20.75		COM Yardage: 1 or 2 seats: .75 yard													
H 43	SH 30.25		Contact Leland Customer Experience for yardage requirements on textiles with repeats.													
			Optional Glides: Add \$8.00 net per chair for a set of four (4). Optional Glides raise chair height .5 inch.													



Slam Sled Bar Chair		MODEL	FRAME FINISH	LIST PRICE
3D Oak veneer shell		SLBS-3D0	Powder Coat	\$1685
W 22	D 20.75		Chrome	\$1759
H 43	SH 30		Optional Glides: Add \$8.00 net per chair for a set of four (4).	



Slam Sled Bar Chair		MODEL	LIST PRICE/GRADE	COM/COL	A	B	C	D	E	F	G	H	I	J	K	L
3D Oak veneer shell, upholstered seat onlay		SLBS-30U	Powder Coat	\$1841	1913	1949	1985	2021	2057	2093	2129	2165	2201	2237	2273	2309
			Chrome	\$1672	1743	1779	1815	1851	1887	1923	1959	1995	2031	2067	2103	2139
W 22	D 20.75		COM Yardage: 1 or 2 seats: .75 yard													
H 43	SH 30.25		Contact Leland Customer Experience for yardage requirements on textiles with repeats.													
			Optional Glides: Add \$8.00 net per chair for a set of four (4). Optional Glides raise chair height .5 inch.													

To specify:
 Please refer to pages 3-4 for complete specifying information.
 Specify all products by their product code.

SLAM 4-LEG BAR CHAIR
 Design: Lievore Altherr Molina, licensed by Sellex

SL29



Slam 4-Leg Bar Chair		MODEL	FRAME FINISH	LIST PRICE
Polypropylene shell		SLB4-PO	Powder Coat	\$1000
W 22	D 19.75		Chrome	\$1084
H 43	SH 30	Optional Glides: Add \$8.00 net per chair for a set of four (4). Optional Glides raise chair height .5 inch.		



Slam 4-Leg Bar Chair		MODEL	LIST PRICE/GRADE	COM/COL	A	B	C	D	E	F	G	H	I	J	K	L
Polypropylene shell, upholstered seat onlay		SLB4-PU	Powder Coat	\$1156	1226	1263	1300	1337	1374	1411	1448	1485	1522	1559	1596	1633
			Chrome	\$1237	1308	1344	1380	1416	1452	1488	1524	1560	1596	1632	1668	1704
W 22	D 19.75	Optional Glides: Add \$8.00 net per chair for a set of four (4). Optional Glides raise chair height .5 inch.														
H 43	SH 30.25	COM Yardage: 1 or 2 seats: .75 yard														
Contact Leland Customer Experience for yardage requirements on textiles with repeats.																
For COL requirements please contact Leland Customer Experience.																



Slam 4-Leg Bar Chair		MODEL	LIST PRICE/GRADE	COM/COL	A	B	C	D	E	F	G	H	I	J	K	L
Fully upholstered		SLB4-FU	Powder Coat	\$1235	1361	1424	1487	1550	1613	1676	1739	1802	1865	1928	1991	2054
			Chrome	\$1319	1444	1507	1570	1633	1696	1759	1822	1885	1948	2011	2074	2137
W 22	D 19.75	Optional Glides: Add \$8.00 net per chair for a set of four (4). Optional Glides raise chair height .5 inch.														
H 43	SH 30.25	COM Yardage: 1 seat: 1.5 yards														
Contact Leland Customer Experience for yardage requirements on textiles with repeats.																
For COL requirements please contact Leland Customer Experience.																

To specify:
 Please refer to pages 3-4 for complete specifying information.
 Specify all products by their product code.

Pricing Effective: January 2025

SLAM SLED BAR CHAIR
 Design: Lievore Altherr Molina, licensed by Sellex

SL30



Slam 4-Leg Bar Chair	MODEL	FRAME FINISH	LIST PRICE
3D Beech veneer shell	SLB4-3DB	Powder Coat	\$1654
W 22 D 19.75		Chrome	\$1740
H 43 SH 30		Optional Glides: Add \$8.00 net per chair for a set of four (4). Optional Glides raise chair height .5 inch.	



Slam 4-Leg Bar Chair	MODEL	LIST PRICE/GRADE	COM/COL	A	B	C	D	E	F	G	H	I	J	K	L
3D Beech veneer shell, upholstered seat onlay	SLB4-3BU	Powder Coat	\$1814	1886	1921	1956	1991	2026	2061	2096	2131	2166	2201	2236	2271
W 22 D 19.75		Chrome	\$1896	1966	2003	2040	2077	2114	2151	2188	2225	2262	2299	2336	2373
H 43 SH 30.25		Optional Glides: Add \$8.00 net per chair for a set of four (4). Optional Glides raise chair height .5 inch.													
		COM Yardage: 1 or 2 seats: .75 yard													
		Contact Leland Customer Experience for yardage requirements on textiles with repeats.													
		For COL requirements please contact Leland Customer Experience.													



Slam 4-Leg Bar Chair	MODEL	FRAME FINISH	LIST PRICE
3D Oak veneer shell	SLB4-3D0	Powder Coat	\$1836
W 22 D 19.75		Chrome	\$1920
H 43 SH 30		Optional Glides: Add \$8.00 net per chair for a seat of four (4).	



Slam 4-Leg Bar Chair	MODEL	LIST PRICE/GRADE	COM/COL	A	B	C	D	E	F	G	H	I	J	K	L
3D Oak veneer shell, upholstered seat onlay	SLB4-30U	Powder Coat	\$1996	2067	2104	2141	2178	2215	2252	2289	2326	2363	2400	2437	2474
W 22 D 19.75		Chrome	\$2076	2148	2183	2218	2253	2288	2323	2358	2393	2428	2463	2498	2533
H 43 SH 30.25		Optional Glides: Add \$8.00 net per chair for a set of four (4). Optional Glides raise chair height .5 inch.													
		COM Yardage: 1 seat: 1.5 yards													
		Contact Leland Customer Experience for yardage requirements on textiles with repeats.													
		For COL requirements please contact Leland Customer Experience.													

To specify:
 Please refer to pages 3-4 for complete specifying information.
 Specify all products by their product code.

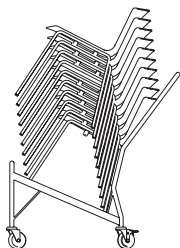

**Slam Transport/
Stacking Dolly**

	MODEL	LIST PRICE
Black powder coat finish	SLD	\$2302
W 25 D 41.25 H 42 (Dimensions of dolly when empty)		Slam Transport/Stacking Dolly capacity: 4-Leg Base: 10 high on dolly (8 high on floor)
W 26 D 45 H 55 (Dimensions with stack)		4-Leg Mobile Base: 8 high on dolly (4 high on floor) **Sled and Aluminum Base does not stack

To specify:
 Please refer to pages 3-4 for complete specifying information.
 Specify all products by their product code.

SLAM LOUNGE CHAIR
 Design: Lievore Altherr Molina, licensed by Sellex

SL32



Slam Lounge

Sled Base

	MODEL	LIST PRICE/GRADE	COM/COL	A	B	C	D	E	F	G	H	I	J	K	L
Fully upholstered	SLL-S	Powder Coat	\$1264	1363	1418	1473	1528	1583	1638	1693	1748	1803	1858	1913	1968
W 27.5 D 27.5		Chrome	\$1345	1444	1499	1554	1609	1664	1719	1774	1829	1884	1939	1994	2049

H 30 SH 17

Optional Glides: Add \$8.00 net per chair for a set of four (4). Optional Glides raise chair height .5 inch.

COM Yardage: 1.75 yards per chair

Contact Leland Customer Experience for yardage requirements on textiles with repeats.

For COL requirements please contact Leland Customer Experience.



Slam Lounge

Pyramidal Base

	MODEL	LIST PRICE/GRADE	COM/COL	A	B	C	D	E	F	G	H	I	J	K	L
Fully upholstered	SLL-P	Powder Coat	\$1833	1933	1988	2043	2098	2153	2208	2263	2318	2373	2428	2483	2538
W 27.5 D 26		Polished Aluminum	\$2531	2630	2683	2736	2789	2842	2895	2948	3001	3054	3107	3160	3213

H 30 SH 17

Optional Glides: Add \$8.00 net per chair for a set of four (4). Optional Glides raise chair height .5 inch.

COM Yardage: 1.75 yards per chair

Contact Leland Customer Experience for yardage requirements on textiles with repeats.

For COL requirements please contact Leland Customer Experience.

To specify:

Please refer to pages 3-4 for complete specifying information.

Specify all products by their product code.

Pricing Effective: January 2024

5695 Eagle Drive, SE
Grand Rapids,
Michigan 49512
616-975-9260
lelandfurniture.com

Valeri Seating

January 2025 Price List



Valeri

Table of Contents	VS2
Specification Information	VS3
Specification Example	VS4
Guest Chair, Lounge Chair, Settee	VS5

Chair Model

DESCRIPTION	CODE
Valeri guest chair	VG
Valeri lounge chair	VL
Valeri settee	VS

Frame Finish

DESCRIPTION	CODE
Brushed stainless steel	SS

Upholstery Selection

Please refer to Leland Textile Program which features textiles and leathers from the following partners:

- Camira
- Carnegie
- CF Stinson
- Green Hides
- Maharam
- Unika Vaev

The complete grade list can be found at lelandinternational.com/ecatalog or you can specify COM/COL. Due to the design of this product, it is recommended that all non pre-approved textile be tested for compatibility.

Glides

Valeri glides are steel swivel with nylon bottom.

Freight Note

Due to the size and nature of Valeri Seating, the Freight Program does not apply to this product. Please contact Customer Experience for a quote.

Specifications required to create the product code

- Model
- Frame Finish
- Upholstery Selection



MODEL

Valeri Lounge Chair (VL)

FRAME FINISH

Brushed Stainless Steel (SS)

UPHOLSTERY SELECTION

Enter upholstery grade, COM or COL. Grade J (J)





Valeria Guest Chair

			MODEL	LIST PRICE/GRADE	COM/COL	A	B	C	D	E	F	G	H	I	J	K	L
W 21.5	D 23	H 29	VG		\$1713	1828	1888	1948	2008	2068	2128	2188	2248	2308	2368	2428	2488
SH 18	AH 24.5																

COM Yardage: 1 or 2 seats: 1.75 yard

Contact Leland Customer Experience for yardage requirements on textiles with repeats.

For COL requirements please contact Leland Customer Experience.

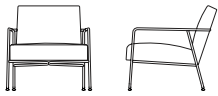

Valeria Lounge Chair

			MODEL	LIST PRICE/GRADE	COM/COL	A	B	C	D	E	F	G	H	I	J	K	L
W 27.5	D 23	H 29	VL		\$2430	2597	2682	2767	2852	2937	3022	3107	3192	3277	3362	3447	3532
SH 18	AH 24.5																

COM Yardage: 1 chair: 2.5 yards; 2 chairs: 3 yards; 3 or 4 chairs: 6 yards; 5 chairs: 6.5 yards

Contact Leland Customer Experience for yardage requirements on textiles with repeats.

For COL requirements please contact Leland Customer Experience.

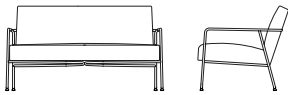

Valeria Settee

			MODEL	LIST PRICE/GRADE	COM/COL	A	B	C	D	E	F	G	H	I	J	K	L
W 50	D 29.5	H 27	VS		\$3801	4136	4304	4472	4640	4808	4976	5144	5312	5480	5648	5816	5984
SH 15	AH 21																

COM Yardage: 1 settee: 3 yards

Due to upholstery requirements, Valeri Settee textile can only be upholstered railroaded.

Please consider when specifying upholstery with a pattern or repeat.

Contact Leland Customer Experience for yardage requirements on textiles with repeats.

For COL requirements please contact Leland Customer Experience.

To specify:

Please refer to pages 3-4 for complete specifying information.

Specify all products by their product code.

5695 Eagle Drive, SE
Grand Rapids,
Michigan 49512
616-975-9260
lelandfurniture.com