

---

LELAND

# Price List

## July 2022



Pricing Effective: July 2022

**July 2022 Pricelist**

Terms & Conditions: Table of Contents	2
Ordering Information	4
Terms, Conditions & General Information	6
Freight Program	9

<b>Amadeus Pricelist</b>	AM
<b>Back Bench Pricelist</b>	BK
<b>Brit Bench Pricelist</b>	BBM
<b>Cambre Table Pricelist</b>	CA
<b>Café Parfait Pricelist</b>	CP
<b>Ease Pricelist</b>	ES
<b>Ebb Fully Upholstered Bench Pricelist</b>	EB
<b>Ebb Veneer Bench Pricelist</b>	EW
<b>Fast Table Pricelist</b>	FT
<b>Fixed Table Pricelist</b>	FXT
<b>Fly Table Pricelist</b>	FLY
<b>Hammok Pricelist</b>	HS
<b>Handy Stool Pricelist</b>	HA
<b>Hifi Table Pricelist</b>	HFT
<b>Leah Table Pricelist</b>	LT
<b>M2 Seating Pricelist</b>	M2S
<b>M3 Table Pricelist</b>	M3T
<b>Marquette Seating Pricelist</b>	MQ

<b>Marquette Table Pricelist</b>	MT
<b>Mass Chair Pricelist</b>	MA
<b>Omena Pricelist</b>	OM
<b>Parfait II Pricelist</b>	PII
<b>Parfait Table Pricelist</b>	PT
<b>Pâtisserie Pricelist</b>	PS
<b>Pluto Bench Pricelist</b>	PB
<b>Quarry Pricelist</b>	QR
<b>Rapson Forty-Eight Chair Pricelist</b>	RP48-C
<b>Rapson Thirty-Nine Bench Pricelist</b>	RP39-B
<b>Rapson Thirty-Nine Guest Pricelist</b>	RP39-G
<b>Rapson Thirty-Nine Lounge Pricelist</b>	RP39-L
<b>Slam Pricelist</b>	SL
<b>Slam Beam Pricelist</b>	SB
<b>Valeri Pricelist</b>	VS

## Orders

---

All orders must be submitted in writing either by fax or e-mail. Specify each item by its product code and the corresponding model description, finish, upholstery and options offered in the price list. If the customer's current product order must match a previous order, Leland International must be notified. A sample product from the original order must be submitted at the expense of the customer to assure uniformity of finish and construction. Orders with missing or incorrect information such as model, finish, color, pricing, etc. will be scheduled upon receipt of correct and complete information.

Leland products are specified for and installed in a variety of end user applications. It is the responsibility of the purchasing party to understand the end user's intent and purchase products appropriate for that application. Leland takes no responsibility for incorrect specifications. Acceptance and fulfillment of any purchase order does not imply that the product is suitable for a certain application. Leland will only warranty products that have been installed in applications for which they were designed.

If multiple delivery schedules are required, the customer must submit separate purchase orders for each delivery date.

## Acknowledgement

---

Orders are only accepted by issuance of our formal acknowledgment. It is the purchaser's responsibility to check acknowledgements and invoices for accuracy. If there is any discrepancy, the customer must notify Leland International within 72 hours. Failure to notify Leland International within this time period will constitute acceptance of the order as acknowledged, and our acknowledgment is final and binding.

All acknowledgments will contain an estimated ship date. If for some reason the furniture must not ship earlier than the estimated ship date, please specify a "Do not ship before date" in your purchase order. We are not responsible for delays in scheduling or failure to make scheduled ship date due to strikes, lockouts or other labor complications, war, riots, Acts of God, fires, accidents, restraints affecting shipment or credit, reduced supply or excessive cost of fuel or raw material, delays from suppliers, compliance with government regulations or other unforeseen contingencies.

## Wood Finishes

---

Wood finishes can be light sensitive; therefore, care should

be taken to avoid placing chairs in areas exposed to intense natural light. Due to variations common to all wood species,

the color and grain characteristics of the finish samples may not exactly match that of the finished product. Custom finishes must meet factory approval and are subject to a \$100.00 minimum net mixing charge. Please allow up to three weeks to prepare the custom wood finish match sample. Orders will not be scheduled or acknowledged until finish match approval is received in writing.

Due to limitations of the raw materials and the natural background color of wood, not all colors can be successfully reproduced. The suitability of a color for custom finish matching cannot always be determined beforehand. This is especially true in the case of custom colors submitted on non-wood products. If we are unable to produce a commercial match to your custom color, you will be notified at the earliest possible date, and no charge will be levied.

## Laminates

---

The following laminates with the manufacturers noted are considered to be standard and are usually in stock.

### FORMICA®

[www.formica.com/en/us/trade-products](http://www.formica.com/en/us/trade-products) or call 800.367.6422

Select solid colors, wood grains or patterns  
 Select number/name  
 Select standard finishes  
 Laminates with -58 (matte finish) are standard

### WILSONART®

[www.wilsonartcontract.com/pattern-availability/](http://www.wilsonartcontract.com/pattern-availability/)  
 or call 800.433.3222

Select laminate finish,  
 Select Leland standard finish -38 (fine velvet texture)  
 or -60 (matte)

### PIONITE®

[www.pionite.com/pionite/pages\\_pionite/pionite\\_colors.html](http://www.pionite.com/pionite/pages_pionite/pionite_colors.html)  
 or call 800.746.6483

Select colors

**Customer's Own Information (COM)**

Leland International reserves the right of preliminary approval of all COM, prior to order acceptance. Even after such preliminary approval, Leland International reserves the right to reject COM if, upon physical inspection of the COM, it proves unacceptable for use on Leland International products. When this occurs, the customer will be notified in writing with an explanation of the problem. A written release from the customer will be required for the order to be processed.

It is recommended that all COM textile be tested for compatibility with Leland's products prior to sending COM to Leland for application. Please contact Customer Experience to request the COM Approval Form with instructions for COM submittal.

Choosing not to have COM textile tested for compatibility may result in the COM being rejected at the expense of the customer.

Leland International cannot assume responsibility for durability, appearance or other qualities of customer's own material on the finished product and does not give any warranty with respect to COM. At Leland International's discretion,

additional yardage, labor charges, or handling surcharges may be required as a condition of COM acceptance. COM delivered to Leland International without proper identification may be refused, and Leland International shall have no responsibility for loss or any other claims. Excess textile will not be returned unless specifically requested in writing.

Please contact the Leland Customer Experience Department for yardage requirements on all COM textiles which are patterned or narrower than 54 inches wide.

Orders using COM may be rescheduled if the COM has not been received two (2) weeks prior to the original ship date. Every effort will be made to avoid a delay and to complete the customer's order within the standard lead time.

All shipments of COM to Leland International must be sent prepaid. COM should be sent to:

LELAND INTERNATIONAL  
5695 Eagle Drive SE  
Grand Rapids, Michigan 49512

COM packages must include the following information:

- Name of customer

- Purchase order number to which the material is to be applied and Leland Sales Order, if known.

Purchase orders specifying COM must include the following:

- Indicate which side of the textile is to be exposed (manufacturer's implied face will be used if no side is indicated by the customer).
- If textile is a stripe or pattern, specify vertical or horizontal upholstered application (textile will be applied off the bolt if no direction is indicated by the customer).
- COM suppliers' name, textile number and quantities of pieces to which the material is to be applied.

**California Technical Bulletin 133 [TB 133]**

TB 133 is a full scale fire performance test of complete articles of seating furniture. Some Leland International products in combination with a variety of upholstery textiles have been tested and are in compliance with TB 133. Test documentation is available upon request. If you wish to specify Leland products that have not been tested for compliance with TB 133 please consult Leland Customer Experience Department for TB 133 testing cost information.

In order for Leland products to comply with TB 133 the foam must be protected with a fire blocker or a special fire retardant foam must be used. For those products that must comply with TB 133 there will be a net charge per chair for fire blocker laminating or fire retardant foam. Please contact Leland International for a CAL 133 quotation on all seating.

Since TB 133 tests furniture and not components, there are no TB 133 approved textiles. Textiles comprised solely or in any combination of the following fibers are more likely to be suitable components for chairs that must comply with TB 133.

Acrylic	Nylon	
Vinyl	Animal Hairs	Polyester
Wool		Virgin
Cordura	Rayon	
Viscose	Cotton	
SEF Modacrylic	Wool	
Leather	Silk	
Worsted Wool	Modacrylic	
Spun Nylon	Mohair	
Trevira		

---

## Prices

All prices are list prices F.O.B. our factory in Grand Rapids, Michigan 49512. Our pricing includes packing and corrugated cartoning for common carrier shipments. List prices do not include freight, storage, taxes or additional packaging required for certain carriers and are subject to change without notice.

We reserve the right to change quotation prices prior to acceptance by the buyer. Quotation prices must be accepted within 30 days unless otherwise specified in writing on the quotation. Pricing on orders specifying shipment 90 days or more after the formal date of acknowledgment will be based on pricing prevailing at time of shipment.

---

## Resale Rights

Leland International reserves the right to reject any order placed by any customer for any reason, irrespective of whether orders have been previously accepted from such customer, without incurring liability to such customer. No customer shall have a continuing right to buy products from the company except pursuant to a formal dealer agreement or other written agreement covering future supply executed by the company and the reseller. Distribution of the price list or catalog does not itself constitute an offer to sell.

---

## Credit and Payment Terms

An open account may be established for new customers. One bank and three trade references will be required and must be faxed to Leland International, attention:

Accounting. Credit will be established upon review and approval of your application.

Allow up to four weeks delay for credit approval. To avoid this delay, orders on new accounts must be accompanied by a 50% deposit. If credit is approved by the time the order is ready for shipment, the balance must be paid within terms. Accounts that are inactive for a twelve month period will automatically be closed and are subject to the above conditions for new accounts. Leland International may change or cancel credit at its discretion and may request advance payment at any time.

Upon establishment of an open account, terms are "Net 15 Days" after date of invoice with a credit limit established on a per customer basis. 1½% per month service charge will be added to all past due accounts. Orders will not be processed for past due accounts until the amount due, including any

service charge, is paid in full. All custom orders will require a down payment of 50% and will not be scheduled for production until the down payment is received.

Leland International reserves the right to revoke the terms of any customer at any time for any reason.

Orders for customers that have pre-paid terms require payment in full in (7) seven business days prior to the scheduled ship date. Payment not received by this day may result in the order being rescheduled.

---

## Changes and Cancellations

Orders are not subject to change or cancellation without factory approval. Leland International will make every reasonable effort to stop production scheduling, shipment, etc., upon receipt of written notification of changes, cancellations or deferments stipulated as follows. Approved cancellations, changes, and delivery date extensions may be subject to charges.

---

## Cancellations

Cancellations received prior to production will be assessed a \$100 net cancellation charge. Cancellations received after production has been started will be assessed the total accumulated cost of the project plus a \$100 net cancellation charge.

---

## Deferred Shipments

If the order is complete or in the production cycle, charges will be assessed from the completion date in accordance with policy for "Storage by the Manufacturer."

---

### Storage by the Manufacturer

If the customer cannot accept delivery when merchandise is ready, according to the terms of our acknowledgment, we reserve the right to transfer goods to storage at the customer's expense, and the order will be invoiced at the time of storage. Payment of this invoice will be due on the original terms given to the customer. Storage charges and freight charges for delivery will be invoiced separately upon release of the merchandise from storage and will be due upon receipt of the invoice. Orders put into storage require payment in full and all incurred storage charges must be paid prior to the order being shipped.

---

### Shipping

We will ship in accordance with the customer's written instructions. If customer omits specific shipping instructions, we will ship in the manner that we consider to be the best way. All shipments are sent F.O.B. Grand Rapids, Michigan 49512. Leland International's liability ends when received by the carrier at Leland International's dock. Title of the goods and risk of loss transfers to the buyer at that time. Freight shall be paid by the buyer unless otherwise acknowledged in writing by Leland International. We make every effort to ship orders complete and on schedule. We reserve the right to make partial shipments as merchandise is ready. Failure to deliver all the merchandise at one time does not relieve the customer of the obligation to accept and pay for merchandise received.

---

### Damage Claims

All Leland International products are thoroughly inspected prior to shipment from our factory and packed to comply with carrier requirements. Customers must carefully inspect all items upon arrival and note any damage on the delivery receipt. Phrasing such as "Subject to Inspection" does not constitute a note of damage and will not be accepted as grounds for honoring a freight claim. A written claim must be filed within 15 days of receipt with the carrier if any obvious or subsequent

concealed damage is discovered and still does not guarantee the honoring of freight claim. Caution: When a clear receipt is obtained by a carrier, Leland International, nor the carrier, are any longer responsible for damages or shortages. Processing claims for damage and shortages are the responsibility of the buyer unless otherwise specified in writing by Leland International. At no time can claims be deducted from our invoices.

---

### Delivery Charges

Charges incurred by Leland International complying with any non-standard shipment request such as inside delivery, expediting, redelivery, weekend delivery, unpacking, straight trucks, specific driver requests, or temporary holding will be invoiced to the purchaser.

---

### Storage by Owner

Due to the inherent nature of wood products, we cannot guarantee any product stored or set in place in an environment where temperature and humidity are not controlled. Temperatures must be maintained within a range of 50°-80° F (10°-27° C); the relative humidity must be maintained between 25% and 40%. These conditions are also recommended for human health standards.

---

### Product Discrepancy

Errors in products including color, size, other variations, or missing components must be reported to Leland International within thirty (30) days of delivery. Failure by the purchaser to report any product inaccuracies within thirty (30) days of delivery shall constitute acceptance of the product.

---

### Miscellaneous

All costs for furniture installation, removal from service and reinstallation due to damage claims, partial shipments, shipping errors or warranty claims is the responsibility of the customer. Leland International will not be liable for costs associated with any of the above conditions.

Sizes and weights are considered to be approximate. Leland International reserves the right to make changes in design and construction or discontinue products without notice. Due to conditions beyond our control all wood products, textiles and vinyls are subject to variations in color, texture and grain.

Price list specifications supersede all other specifications whether verbal or written, and may not be altered without the written consent of an officer of Leland International. All clerical errors on any agreement, publication, correspondence, price list, or product literature pieces are subject to correction at any time.

## MAINTENANCE

---

Since chairs and tables are installed and used under a variety of conditions, users must make inspections no less than every six months to look for damage or signs of structural fatigue incurred in daily handling, use and abuse. Examinations must include welds, machine screw assemblies and the shell to base fasteners. If problems are discovered that could compromise the structural safety of a chair, it should be immediately removed from service and Leland International should be notified. Coats and other articles should not be hung on the back of chairs. This practice may cause chairs to be unstable. Chairs are not designed to be placed seat down on table surfaces. Chairs stored in this manner are unstable. The shock of chairs falling from table tops may compromise the structural integrity of the shell/base attachment.

signs of structural fatigue incurred in daily handling, use, or abuse. Inspections must include, but are not limited to, the tightening of bolts and fasteners, and the lubrication of mechanisms. Failure to properly maintain Leland products will void this warranty.

Leland International will not be liable for loss of time, inconvenience, commercial loss, or incidental or consequential damages that may result from a warranty claim.

## Warranty

---

All merchandise is manufactured in accordance with our high industrial and design standards and is warranted to be free from defects of material and workmanship for a period of (5) five years from the date of delivery or placement in storage. This warranty covers goods under normal use and is in service under conditions for which the merchandise is designed. Leland International considers normal use to be (5) five days per week (8) eight hours per day. Extended use (multiple shifts, 24 hour facilities, etc) will reduce this warranty to (2) two years. We offer no warranty on chair upholstery materials, plastic laminate table surfaces and operating components other than those expressed by the manufacturer of those components.

Our obligation during this warranty period is limited to repair or replacement at our option. This warranty becomes null and void on any goods repaired or altered by any person not so authorized by Leland International or any merchandise which has been subject to misuse, improper storage, including placing chairs seat down on tables, negligence, or accident. We make no other warranties either expressed or implied as to any matter whatsoever, including without limitation, the condition of the merchandise, its merchantability, or its fitness for any particular user or purpose.

All claims will be processed by the Customer Experience Department. All returns must be authorized in writing. Merchandise authorized for return and subsequent repair or replacement merchandise shall be removed from service. All shipping, packaging, and installation charges shall be at the expense of the customer. Since furniture is installed and used under a variety of conditions, users are required to make inspections every six months to look for damage or



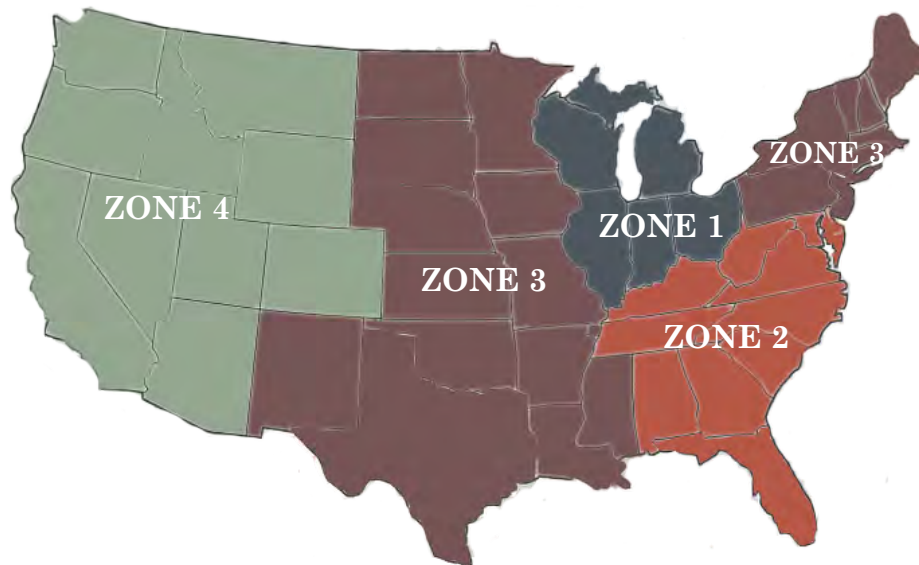

Zone 1 (4%)	Zone 2 (5%)	Zone 3 (6%)	Zone 3 (6%) CONT.	Zone 4 (7%)
Indiana	Alabama	Arkansas	New Hampshire	Arizona
Illinois	Delaware	Connecticut	New Jersey	California
Michigan	Florida	Iowa	New Mexico	Colorado
Ohio	Georgia	Kansas	New York	Idaho
Wisconsin	Kentucky	Louisiana	North Dakota	Montana
	Maryland	Maine	Oklahoma	Nevada
	North Carolina	Massachusetts	Pennsylvania	Oregon
	South Carolina	Minnesota	Rhode Island	Utah
	Tennessee	Mississippi	South Dakota	Washington
	Virginia	Missouri	Texas	Wyoming
	Washington DC	Nebraska	Vermont	
	West Virginia			

**Overview**

Leland Furniture's Freight Program is offered to all customers for convenient and competitive freight prices in the continental United States.

**How It Works**

1. Determine the LIST value of your order.
2. Determine the zone to which the freight will be shipping (Zones 1-4)
3. Calculate your freight charges by multiplying the list price and applicable zone charges (e.g.: \$10,000 LIST order shipping to Arizona is \$10,000 x 0.07 = \$700 NET freight).
4. Verify that your calculated charges meet or exceed minimums.
5. Note on your PO "Freight determined by Leland Freight Program".

**Zone Percentages and Minimums**

Zone 1	4%	Minimum \$350
Zone 2	5%	Minimum \$350
Zone 3	6%	Minimum \$350
Zone 4	7%	Minimum \$350

**Remember**

Freight percentages are based on LIST price of order.

Leland Furniture Freight Program is based on dockside delivery only. Residential Delivery, Inside Delivery, etc. will incur additional charges; please contact Leland Customer Service for current prices.

Freight is FOB Grand Rapids, MI 49512; the receiving company is responsible for noting any damage at the time of delivery on the Delivery Receipt. Leland Furniture assumes no responsibility for freight damage, either noted on delivery receipt or concealed.

As fuel prices fluctuate, Leland Furniture reserves the right to add necessary fuel surcharges.

Leland Furniture reserves the right to change or discontinue the Freight Program at any time.

# Amadeus

## July 2022 Price List



# Amadeus

Table of Contents	AM2
Specification Information	AM3
Specification Example	AM4
Stacking/ganging sled base	AM5
Stacking Chair Tapered Four Leg Base	AM7
Arm Chair, Tapered Four Leg Base	AM9
Side Chair, Wood Base	AM11
Counter Chair, Sled base	AM13
Counter Chair, Wood Base	AM15
Bar Chair, Sled base	AM17
Bar Chair, Wood Base	AM19

## Chair Model

DESCRIPTION	CODE
AMADEUS stacking/ganging sled base	AMS
AMADEUS stacking chair, tapered four leg base	AM4
AMADEUS arm chair, tapered four leg base	AMA
AMADEUS side chair, wood base	AMSW
AMADEUS counter chair	AMCS
AMADEUS counter chair, wood base	AMCW
AMADEUS bar chair	AMBS
AMADEUS bar chair, wood base	AMBW

## Shell Selection

DESCRIPTION	CODE
Polypropylene	PO
Polypropylene with Upholstered Seat Only	PU
Fully Upholstered	FU
3D Beech Veneer	3DB
3D Beech Veneer with Upholstered Seat Only	3BU
3D American Walnut Veneer	3DW
3D American Walnut Veneer with Upholstered Seat Only	3WU

## Shell Finish/Color

### POLYPROPYLENE SHELL:

DESCRIPTION	CODE	DESCRIPTION	CODE
White	WT	Arctic	AR
Black	BK	Caribbean	CB
Soda Red	SR	Ink	IN
Dolphin	DL	Limelight	LL
Oxford	OX	Tangerine	TN
Ice Blue	IB		

### CUSTOM POLYPROPYLENE COLORS

Custom color match is available upon request.  
Please contact [hello@lelandfurniture.com](mailto:hello@lelandfurniture.com) for further information

### BEECH 3D VENEER SHELL:

DESCRIPTION	CODE
Natural Beech	09

### STANDARD LELAND COLORS

### AMERICAN WALNUT 3D VENEER SHELL:

DESCRIPTION	CODE
Natural Walnut Matte	08M

## Fully Upholstered or Only Selection

Please refer to Leland Textile Program which features textiles and leathers from the following partners:

- Camira
- Green Hides
- Carnegie
- Maharam
- CF Stinson
- Unika Vaev

The complete grade list can be found on our website or you can specify COM/COL. Due to the design of this product, it is recommended that all non pre-approved textile be tested for compatibility.

## Frame Finishes

### SLED BASE & TAPERED FOUR LEG BASE:

DESCRIPTION	CODE
Sterling	ST
Warm Grey	WG
Cool Grey	CG
Black	B
White	W
Matte Gold Rush	MGR
Matte Mercury	MMR
Matte Mineral	MMN
Matte Burnish	MBN
Matte Foundry	MFN
Chrome	C

### TEXTURED

DESCRIPTION	CODE
White Textured Powder coat	WT
Black Textured Powder coat	BT
Grey Textured Powder coat	GT
Soda Red Textured	SRT
Dolphin Textured	DLT
Oxford Textured	OXT
Tangerine Textured	TNT
Ice Blue Textured	IBT
Artic Textured	ART
Caribbean Textured	CBT
Limelight Textured	LLT
Ink Textured	INT

## Glide or Caster Type

### STANDARD GLIDES:

DESCRIPTION	CODE
Poly (Sled base)	S
Nylon (Tapered Four leg Base) & Wood Base	S

### OPTIONAL GLIDES:

DESCRIPTION	CODE
Felt	FC

\*Please note that optional glides for four leg models raise the chair height .5 inch.

## Stacking note

Amadeus side chair, armless models stack as follows: (including upholstered)

### SLED BASE:

ARMLESS:  
Floor: 15 High  
Dolly: 20 High

### TAPERED FOUR LEG BASE:

ARMLESS:  
Floor: 10 High  
Dolly: 12 High

**Specifications required to create the product code**

- Model
- Shell Selection
- Shell Finish/Color
- Upholstered Onlay Selection (when applicable)
- Frame Finish (or foot ring where applicable)
- Glide Type

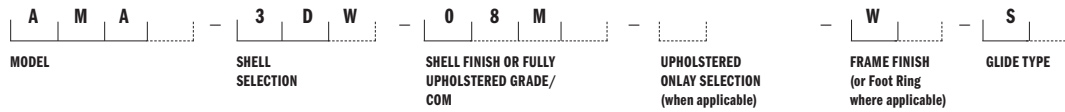

**MODEL**

Amadeus arm chair, Tapered four leg base (AMA)

**SHELL SELECTION**

3D American Walnut Veneer (3DW)

**SHELL FINISH/COLOR**

Natural Walnut Matte (08M)

**UPHOLSTERED ONLAY SELECTION**

When applicable, enter upholstery grade, COM

**FRAME FINISH (OR FOOT RING WHERE APPLICABLE)**

White (W)

**GLIDE TYPE**

Standard Nylon (S)



AMADEUS STACKING/GANGING SLED BASE  
Design: Martin Ballendat

AM5



Amadeus Sled Base Chair	MODEL	FRAME FINISH	LIST PRICE
Polypropylene shell	AMS-PO	Powder Coat	\$381
W 21 D 21.75 H 31.75 SH 18		Chrome	\$441

Optional Glides: Add \$8.00 net per chair for a set of four (4).



Amadeus Sled Base Chair	MODEL	LIST PRICE/GRADE	COM/COL	A	B	C	D	E	F	G	H	I	J	K	L
Polypropylene shell upholstered seat onlay	AMS-PU	Powder Coat	\$512	554	574	595	616	636	658	678	699	719	741	761	782
		Chrome	\$571	613	633	654	675	696	716	737	758	778	800	820	841

W 21 D 21.75 H 32 SH 19

COM Yardage: 1 or 2 seats: .75 yard  
Contact Leland Customer Experience for yardage requirements on textiles with repeats.  
Optional Glides: Add \$8.00 net per chair for a set of four (4).



Amadeus Sled Base Chair	MODEL	LIST PRICE/GRADE	COM/COL	A	B	C	D	E	F	G	H	I	J	K	L
Fully upholstered	AMS-FU	Powder Coat	\$690	782	829	876	922	970	1017	1064	1110	1158	1205	1252	1299
		Chrome	\$755	849	895	942	989	1036	1084	1130	1177	1224	1272	1319	1365

W 21 D 21.75 H 32 SH 18

COM Yardage: 1 seat: 1.5 yards  
Contact Leland Customer Experience for yardage requirements on textiles with repeats.  
Optional Glides: Add \$8.00 net per chair for a set of four (4).

To specify:  
Please refer to pages 3-4 for complete specifying information.  
Specify all products by their product code.

Pricing Effective: February 2022

---

---



**Amadeus  
Tapered Four Leg Base Chair**

	MODEL	FRAME FINISH	LIST PRICE
Polypropylene shell	AM4-PO	Powder Coat	\$439
W 21 D 22 H 32 SH 18		Chrome	\$500

Optional Glides: Add \$8.00 net per chair for a set of four (4).



**Amadeus  
Tapered Four Leg Base Chair**

	MODEL	LIST PRICE/GRADE	COM/COL	A	B	C	D	E	F	G	H	I	J	K	L
Polypropylene shell, upholstered seat onlay	AM4-PU	Powder Coat	\$570	612	632	653	674	694	715	736	757	777	798	819	840
		Chrome	\$630	671	692	713	733	755	775	796	817	838	858	880	900

W 21.5 D 22 H 32 SH 19

COM Yardage: 1 or 2 seats: .75 yard  
Contact Leland Customer Experience for yardage requirements on textiles with repeats.  
Optional Glides: Add \$8.00 net per chair for a set of four (4).



**Amadeus  
Tapered Four Leg Base Chair**

	MODEL	LIST PRICE/GRADE	COM/COL	A	B	C	D	E	F	G	H	I	J	K	L
Fully upholstered	AM4-FU	Powder Coat	\$754	847	894	941	988	1035	1083	1129	1176	1223	1271	1317	1364
		Chrome	\$821	916	963	1009	1057	1103	1150	1196	1244	1291	1338	1384	1431

W 21.5 D 22 H 32 SH 18

COM Yardage: 1 seat: 1.5 yards  
Contact Leland Customer Experience for yardage requirements on textiles with repeats.  
Optional Glides: Add \$8.00 net per chair for a set of four (4).

To specify:  
Please refer to pages 3-4 for complete specifying information.  
Specify all products by their product code.





**Amadeus  
Tapered Four Leg Base Chair**

	MODEL	FRAME FINISH	LIST PRICE
3D Beech veneer shell	AM4-3DB	Powder Coat	\$798
W 21.5 D 22 H 32 SH 18		Chrome	\$861

Optional Glides: Add \$8.00 net per chair for a set of four (4).



**Amadeus  
Tapered Four Leg Base Chair**

	MODEL	LIST PRICE/GRADE	COM/COL	A	B	C	D	E	F	G	H	I	J	K	L
3D Beech veneer shell, upholstered seat onlay	AM4-3BU	Powder Coat	\$937	983	1004	1027	1049	1072	1093	1117	1138	1161	1184	1206	1228
		Chrome	\$1001	1045	1069	1090	1113	1135	1157	1179	1202	1224	1246	1270	1291

W 21.5 D 22 H 32 SH 19

COM Yardage: 1 or 2 seats: .75 yard  
Contact Leland Customer Experience for yardage requirements on textiles with repeats.  
Optional Glides: Add \$8.00 net per chair for a set of four (4).



**Amadeus  
Tapered Four Leg Base Chair**

	MODEL	FRAME FINISH	LIST PRICE
3D Walnut veneer shell	AM4-3DW	Powder Coat	\$1124
W 21.5 D 22 H 32 SH 18		Chrome	\$1190

Optional Glides: Add \$8.00 net per chair for a set of four (4).



**Amadeus  
Tapered Four Leg Base Chair**

	MODEL	LIST PRICE/ GRADE	COM/COL	A	B	C	D	E	F	G	H	I	J	K	L
3D Walnut veneer shell upholstered seat onlay	AM4-3WU	Powder Coat	\$1265	1309	1332	1355	1377	1399	1422	1444	1466	1489	1511	1533	1557
		Chrome	\$1330	1375	1396	1419	1442	1464	1486	1509	1531	1552	1576	1597	1620

W 21.5 D 22 H 32 SH 19

COM Yardage: 1 or 2 seats: .75 yard  
Contact Leland Customer Experience for yardage requirements on textiles with repeats.  
Optional Glides: Add \$8.00 net per chair for a set of four (4).

**To specify:  
Please refer to pages 3-4 for  
complete specifying information.  
Specify all products by their  
product code.**

AMADEUS ARM CHAIR, TAPERED FOUR LEG BASE  
Design: Martin Ballendat

AM9



**Amadeus Arm Chair  
Tapered Four Leg Base Chair**

	MODEL	FRAME FINISH	LIST PRICE
Polypropylene shell	AMA-PO	Powder Coat	\$547
W 23.5 D 21.75 H 32 SH 18 AH 26		Chrome	\$650

Optional Glides: Add \$8.00 net per chair for a set of four (4).



**Amadeus Arm Chair  
Tapered Four Leg Base Chair**

	MODEL	LIST PRICE/GRADE	COM/COL	A	B	C	D	E	F	G	H	I	J	K	L
Polypropylene shell, upholstered seat onlay	AMA-PU	Powder Coat	\$697	745	769	794	818	841	866	889	912	937	960	984	1007
		Chrome	\$781	829	853	876	902	925	949	972	997	1020	1044	1068	1091

W 23.75 D 22 H 32  
SH 19 AH 26

COM Yardage: 1 or 2 seats: .75 yard  
Contact Leland Customer Experience for yardage requirements on textiles with repeats.  
Optional Glides: Add \$8.00 net per chair for a set of four (4).



**Amadeus  
Tapered Four Leg Base Chair**

	MODEL	LIST PRICE/GRADE	COM/COL	A	B	C	D	E	F	G	H	I	J	K	L
Fully upholstered	AMA-FU	Powder Coat	\$907	1013	1067	1121	1175	1227	1281	1335	1389	1442	1493	1547	1601
		Chrome	\$1000	1106	1160	1214	1267	1321	1374	1428	1481	1535	1589	1643	1694

W 23.5 D 21.75 H 32  
SH 18 H 26

COM Yardage: 1 seat: 1.5 yards  
Contact Leland Customer Experience for yardage requirements on textiles with repeats.  
Optional Glides: Add \$8.00 net per chair for a set of four (4).

To specify:  
Please refer to pages 3-4 for complete specifying information.  
Specify all products by their product code.

Pricing Effective: February 2022

AMADEUS ARM CHAIR, TAPERED FOUR LEG BASE  
Design: Martin Ballendat

AM10



**Amadeus Arm Chair  
Tapered Four Leg Base**

	MODEL	FRAME FINISH	LIST PRICE
3D Beech veneer shell	AMA-3DB	Powder Coat	\$991
W 23.75 D 22 H 32 SH 19 AH 26		Chrome	\$1101

Optional Glides: Add \$8.00 net per chair for a set of four (4).



**Amadeus Arm Chair  
Tapered Four Leg Base Chair**

	MODEL	LIST PRICE/ GRADE	COM/COL	A	B	C	D	E	F	G	H	I	J	K	L
3D Beech veneer shell, upholstered seat onlay	AMA-3BU	Powder Coat	\$1150	1202	1226	1253	1278	1303	1329	1354	1379	1404	1431	1455	1481
		Chrome	\$1227	1279	1305	1330	1356	1381	1408	1432	1457	1483	1508	1534	1558

W 23.75 D 22 H 32  
SH 19 AH 26

COM Yardage: 1 or 2 seats: .75 yard  
Contact Leland Customer Experience for yardage requirements on textiles with repeats.  
Optional Glides: Add \$8.00 net per chair for a set of four (4).



**Amadeus Arm Chair  
Tapered Four Leg Base**

	MODEL	FRAME FINISH	LIST PRICE
3D Walnut veneer shell	AMA-3DW	Powder Coat	\$1401
W 23.5 D 21.75 H 32 SH 18 AH 26		Chrome	\$1512

Optional Glides: Add \$8.00 net per chair for a set of four (4).



**Amadeus Arm Chair  
Tapered Four Leg Base**

	MODEL	LIST PRICE/ GRADE	COM/COL	A	B	C	D	E	F	G	H	I	J	K	L
3D Walnut veneer shell, upholstered seat onlay	AMA-3WU	Powder Coat	\$1562	1612	1639	1664	1689	1714	1741	1765	1791	1817	1842	1867	1894
		Chrome	\$1668	1720	1744	1769	1796	1820	1846	1872	1898	1922	1949	1973	1999

W 23.5 D 22 H 32  
SH 19 H 26

COM Yardage: 1 or 2 seats: .75 yard  
Contact Leland Customer Experience for yardage requirements on textiles with repeats.  
Optional Glides: Add \$8.00 net per chair for a set of four (4).

To specify:  
Please refer to pages 3-4 for  
complete specifying information.  
Specify all products by their  
product code.

AMADEUS SIDE CHAIR, POLY SHELL, WOOD BASE  
 Design: Martin Ballendat

AM11

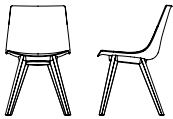

**Amadeus Side Chair**

Wood Base	MODEL	FRAME FINISH	LIST PRICE
Polypropylene shell	AMSW-PO		\$801
W 19 D 22 H 32 SH 18		Optional Glides: Add \$8.00 net per chair for a set of four (4).	

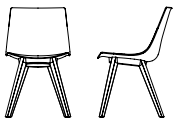

**Amadeus Side Chair**

Wood Base	MODEL	LIST PRICE/GRADE	COM/COL	A	B	C	D	E	F	G	H	I	J	K	L
Polypropylene shell, upholstered seat onlay	AMSW-PU		\$931	972	994	1014	1035	1056	1076	1097	1118	1139	1159	1181	1201
W 19 D 22 H 32 SH 19		COM Yardage: 1 or 2 seats: .75 yard Contact Leland Customer Experience for yardage requirements on textiles with repeats. Optional Glides: Add \$8.00 net per chair for a set of four (4)													

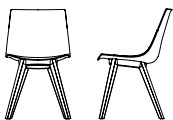

**Amadeus Side Chair**

Wood Base	MODEL	LIST PRICE/GRADE	COM/COL	A	B	C	D	E	F	G	H	I	J	K	L
Fully upholstered	AMSW-FU		\$1162	1256	1303	1349	1396	1444	1491	1537	1585	1631	1677	1724	1772
W 19 D 22 H 32.5 SH 18		COM Yardage: 1 seat: 1.5 yards Contact Leland Customer Experience for yardage requirements on textiles with repeats. Optional Glides: Add \$8.00 net per chair for a set of four (4)													

To specify:  
 Please refer to pages 3-4 for complete specifying information.  
 Specify all products by their product code.

Pricing Effective: February 2022

AMADEUS SIDE CHAIR, WOOD BASE  
Design: Martin Ballendat

AM12

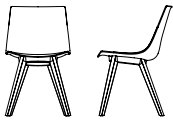

**Amadeus Side Chair  
Wood Base**

	MODEL	FRAME FINISH	LIST PRICE
3D beech veneer shell	AMSW-3DB		\$1603
W 19 D 22 H 32 SH 18		Optional Glides: Add \$8.00 net per chair for a set of four (4).	

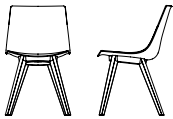

**Amadeus Side Chair  
Wood Base**

	MODEL	LIST PRICE/ GRADE	COM/ COL	A	B	C	D	E	F	G	H	I	J	K	L
3D beech veneer shell, upholstered seat onlay	AMSW-3BU		\$1744	1788	1809	1833	1854	1877	1900	1922	1944	1967	1989	2011	2034
W 19 D 22 H 32 SH 18		COM Yardage: 1 or 2 seats: .75 yard Contact Leland Customer Experience for yardage requirements on textiles with repeats. Optional Glides: Add \$8.00 net per chair for a set of four (4)													

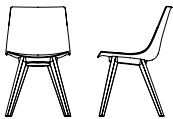

**Amadeus Side Chair  
Wood Base**

	MODEL	FRAME FINISH	LIST PRICE
3D american walnut veneer shell	AMSW-3DW		\$1931
W 19 D 22 H 32 SH 18		Optional Glides: Add \$8.00 net per chair for a set of four (4).	

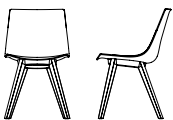

**Amadeus Side Chair  
Wood Base**

	MODEL	LIST PRICE/ GRADE	COM/ COL	A	B	C	D	E	F	G	H	I	J	K	L
3D american walnut veneer shell, upholstered seat onlay	AMSW-3WU		\$2070	2115	2138	2160	2182	2205	2227	2249	2273	2294	2317	2339	2362
W 19 D 22 H 32 SH 18		COM Yardage: 1 or 2 seats: .75 yard Contact Leland Customer Experience for yardage requirements on textiles with repeats. Optional Glides: Add \$8.00 net per chair for a set of four (4)													

To specify:  
Please refer to pages 3-4 for  
complete specifying information.  
Specify all products by their  
product code.

Pricing Effective: February 2022

AMADEUS COUNTER CHAIR, SLED BASE  
Design: Martin Ballendat

AM13

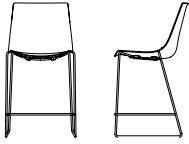

**Amadeus Counter Chair,  
Sled Base**

	MODEL	FRAME FINISH	LIST PRICE
Polypropylene shell	AMCS-PO	Powder Coat	\$603
W 20.5 D 21.5 H 38.5 SH 26		Chrome	\$675

Optional Glides: Add \$8.00 net per chair for a set of four (4).

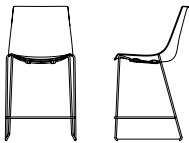

**Amadeus Counter Chair,  
Sled Base**

	MODEL	LIST PRICE/GRADE	COM/COL	A	B	C	D	E	F	G	H	I	J	K	L
Polypropylene shell, upholstered seat onlay	AMCS-PU	Powder Coat	\$733	775	796	817	838	858	880	900	920	942	962	983	1003
		Chrome	\$805	847	868	888	910	930	951	971	993	1013	1033	1055	1075

W 20.5 D 21.5 H 38.5 SH 26

COM Yardage: 1 or 2 seats: .75 yard  
Contact Leland Customer Experience for yardage requirements on textiles with repeats.  
For COL requirements please contact Leland Customer Experience.  
Optional Glides: Add \$8.00 net per chair for a set of four (4).

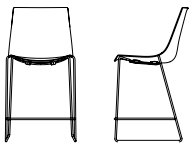

**Amadeus Counter Chair,  
Sled Base**

	MODEL	LIST PRICE/GRADE	COM/ COL	A	B	C	D	E	F	G	H	I	J	K	L
Fully upholstered	AMCS-FU	Powder Coat	\$938	1033	1080	1127	1174	1221	1269	1315	1362	1408	1454	1501	1548
		Chrome	\$1019	1113	1160	1207	1255	1302	1348	1395	1443	1490	1536	1582	1630

W 20.5 D 21.5 H 38.5 SH 26

COM Yardage: 1 seat: 1.5 yards  
Contact Leland Customer Experience for yardage requirements on textiles with repeats.  
For COL requirements please contact Leland Customer Experience.  
Optional Glides: Add \$8.00 net per chair for a set of four (4).

To specify:  
Please refer to pages 3-4 for complete specifying information.  
Specify all products by their product code.

AMADEUS COUNTER CHAIR, SLED BASE  
Design: Martin Ballendat

AM14

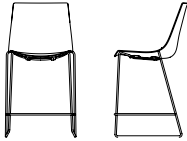

**Amadeus Counter Chair,  
Sled Base**

	MODEL	FRAME FINISH	LIST PRICE
3D Beech veneer shell	AMCS-3DB	Powder Coat	\$1267
W 21 D 21.5 H 38.5 SH 26		Chrome	\$1344

Optional Glides: Add \$8.00 net per chair for a set of four (4).

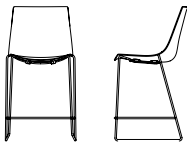

**Amadeus Counter Chair,  
Sled Base**

	MODEL	LIST PRICE/ GRADE	COM/COL	A	B	C	D	E	F	G	H	I	J	K	L
3D Beech veneer shell, upholstered seat onlay	AMCS-3BU	Powder Coat	\$1407	1451	1474	1496	1518	1542	1563	1586	1608	1631	1652	1674	1697
		Chrome	\$1484	1529	1550	1574	1595	1618	1639	1663	1685	1707	1730	1751	1774

W 20.5 D 21.5 H 38.5 SH 26

COM Yardage: 1 or 2 seats: .75 yard  
Contact Leland Customer Experience for yardage requirements on textiles with repeats.  
Optional Glides: Add \$8.00 net per chair for a set of four (4).

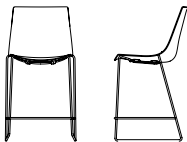

**Amadeus Counter Chair,  
Sled Base**

	MODEL	FRAME FINISH	LIST PRICE
3D Walnut veneer shell	AMCS-3DW	Powder Coat	\$1437
W 20.5 D 21.5 H 38.5 SH 26		Chrome	\$1513

Optional Glides: Add \$8.00 net per chair for a set of four (4).

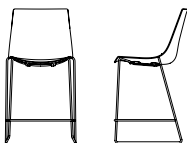

**Amadeus Sled Base Chair**

	MODEL	LIST PRICE/GRADE	COM/ COL	A	B	C	D	E	F	G	H	I	J	K	L
3D Walnut veneer shell, upholstered seat onlay	AMCS-3WU	Powder Coat	\$1577	1621	1644	1666	1688	1711	1733	1755	1778	1801	1822	1846	1867
		Chrome	\$1652	1697	1719	1742	1764	1787	1808	1832	1853	1876	1898	1921	1943

W 20.5 D 21.5 H 38.5 SH 26

COM Yardage: 1 or 2 seats: .75 yard  
Contact Leland Customer Experience for yardage requirements on textiles with repeats.  
Optional Glides: Add \$8.00 net per chair for a set of four (4).

To specify:

Please refer to pages 3-4 for complete specifying information.  
Specify all products by their product code.

AMADEUS COUNTER CHAIR, WOOD BASE  
Design: Martin Ballendat

AM15

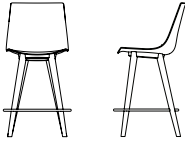

**Amadeus Counter Chair**

**Wood Base**

	MODEL	FRAME FINISH	LIST PRICE
Polypropylene shell	AMCW-PO		\$1158
W 20 D 22.5 H 40 SH 25.5		Optional Glides: Add \$8.00 net per chair for a set of four (4).	

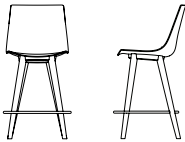

**Amadeus Counter Chair**

**Wood Base**

	MODEL	LIST PRICE/ GRADE	COM/ COL	A	B	C	D	E	F	G	H	I	J	K	L
Polypropylene shell, upholstered seat onlay	AMCW-PU		\$1288	1330	1351	1372	1393	1413	1435	1455	1476	1497	1518	1538	1560
W 20 D 22.5 H 40 SH 25.5			COM Yardage: 1 or 2 seats: .75 yard Contact Leland Customer Experience for yardage requirements on textiles with repeats. Optional Glides: Add \$8.00 net per chair for a set of four (4)												

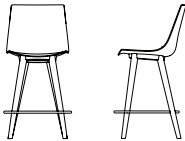

**Amadeus Counter Chair**

**Wood Base**

	MODEL	LIST PRICE/ GRADE	COM/ COL	A	B	C	D	E	F	G	H	I	J	K	L
Fully upholstered	AMCW-FU		\$1565	1660	1706	1753	1801	1848	1894	1941	1989	2035	2081	2129	2176
W 20 D 22.5 H 40 SH 25.5			COM Yardage: 1 seat: 1.5 yards Contact Leland Customer Experience for yardage requirements on textiles with repeats. Optional Glides: Add \$8.00 net per chair for a set of four (4).												

**To specify:**

Please refer to pages 3-4 for complete specifying information. Specify all products by their product code.



AMADEUS COUNTER CHAIR, WOOD BASE  
Design: Martin Ballendat

AM16

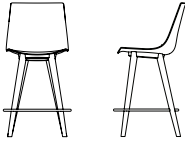

**Amadeus Counter Chair**

Wood Base	MODEL	FRAME FINISH	LIST PRICE
3D Beech veneer shell	AMCW-3DB		\$1988
W 20 D 22.5 H 40 SH 25.5		Optional Glides: Add \$8.00 net per chair for a set of four (4).	

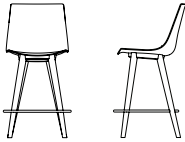

**Amadeus Counter Chair**  
**Wood Base**

MODEL	LIST PRICE/ GRADE	COM/ COL	A	B	C	D	E	F	G	H	I	J	K	L
3D Beech veneer shell, upholstered seat onlay	AMCW-3BU	\$2127	2173	2195	2217	2240	2262	2283	2307	2328	2351	2374	2396	2418
W 20 D 22.5 H 40 SH 26		COM Yardage: 1 or 2 seats: .75 yard Contact Leland Customer Experience for yardage requirements on textiles with repeats. Optional Glides: Add \$8.00 net per chair for a set of four (4)												

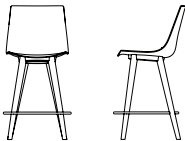

**Amadeus Counter Chair**  
**Wood Base**

MODEL	FRAME FINISH	LIST PRICE
3D American walnut veneer shell	AMCW-3DW	\$2259
W 20 D 22.5 H 40 SH 25.5	Optional Glides: Add \$8.00 net per chair for a set of four (4).	

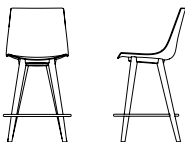

**Amadeus Counter Chair**  
**Wood Base**

MODEL	LIST PRICE/ GRADE	COM/ COL	A	B	C	D	E	F	G	H	I	J	K	L
3D American walnut veneer shell, upholstered seat onlay	AMCW-3WU	\$2398	2443	2465	2488	2510	2533	2554	2578	2599	2622	2645	2667	2689
W 20 D 22.5 H 40 SH 26		COM Yardage: 1 or 2 seats: .75 yard Contact Leland Customer Experience for yardage requirements on textiles with repeats. Optional Glides: Add \$8.00 net per chair for a set of four (4)												

To specify:  
Please refer to pages 3-4 for  
complete specifying information.  
Specify all products by their  
product code.

AMADEUS BAR CHAIR, SLED BASE  
Design: Martin Ballendat

AM17

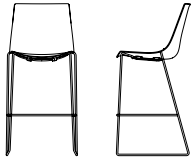

**Amadeus Bar Chair  
Sled Base**

	MODEL	FRAME FINISH	LIST PRICE
Polypropylene shell	AMBS-PO	Powder Coat	\$685
W 20.5 D 21.5 H 43.75 SH 29		Chrome	\$747

Optional Glides: Add \$8.00 net per chair for a set of four (4).

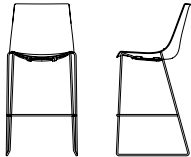

**Amadeus Bar Chair  
Sled Base**

	MODEL	LIST PRICE/GRADE	COM/COL	A	B	C	D	E	F	G	H	I	J	K	L
Polypropylene shell upholstered seat onlay	AMBS-PU	Powder Coat	\$816	857	877	899	919	940	961	982	1002	1024	1044	1065	1086
		Chrome	\$877	919	940	961	982	1002	1024	1044	1065	1086	1107	1127	1149

W 21 D 21.5 H 44 SH 30

COM Yardage: 1 or 2 seats: .75 yard  
Contact Leland Customer Experience for yardage requirements on textiles with repeats.  
For COL requirements please contact Leland Customer Experience.  
Optional Glides: Add \$8.00 net per chair for a set of four (4).

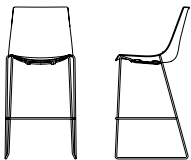

**Amadeus Bar Chair  
Sled Base**

	MODEL	LIST PRICE/ GRADE	COM/COL	A	B	C	D	E	F	G	H	I	J	K	L
Fully upholstered	AMBS-FU	Powder Coat	\$1032	1126	1173	1220	1267	1314	1360	1406	1452	1500	1547	1594	1642
		Chrome	\$1102	1195	1243	1290	1336	1382	1430	1477	1524	1571	1618	1665	1712

W 20.5 D 21.5 H 43.75  
SH 29

COM Yardage: 1 seat: 1.5 yards  
Contact Leland Customer Experience for yardage requirements on textiles with repeats.  
For COL requirements please contact Leland Customer Experience.  
Optional Glides: Add \$8.00 net per chair for a set of four (4).

To specify:  
Please refer to pages 3-4 for  
complete specifying information.  
Specify all products by their  
product code.

AMADEUS BAR CHAIR, SLED BASE  
Design: Martin Ballendat

AM18

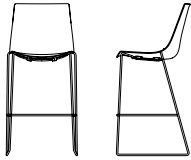

**Amadeus Bar Chair  
Sled Base**

	MODEL	FRAME FINISH	LIST PRICE
3D Beech veneer shell	AMBS-3DB	Powder Coat	\$1355
W 20.5 D21.5 H 43.75 SH 29		Chrome	\$1421

Optional Glides: Add \$8.00 net per chair for a set of four (4).

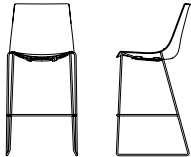

**Amadeus Bar Chair  
Sled Base**

	MODEL	LIST PRICE/ GRADE	COM/COL	A	B	C	D	E	F	G	H	I	J	K	L
3D Beech veneer shell, upholstered onlay	AMBS-3BU	Powder Coat	\$1495	1540	1562	1583	1607	1629	1651	1673	1696	1718	1740	1763	1786
		Chrome	\$1561	1605	1628	1650	1672	1695	1717	1739	1762	1785	1806	1830	1851

W 21 D 21.5 H 44 SH 30

COM Yardage: 1 or 2 seats: .75 yard  
Contact Leland Customer Experience for yardage requirements on textiles with repeats.  
For COL requirements please contact Leland Customer Experience.  
Optional Glides: Add \$8.00 net per chair for a set of four (4).

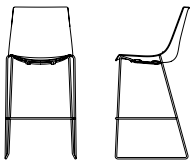

**Amadeus Bar Chair  
Sled Base**

	MODEL	FRAME FINISH	LIST PRICE
3D Walnut veneer shell	AMBS-3DW	Powder Coat	\$1525
W 21 D21.5 H 44 SH 29.5		Chrome	\$1591

Optional Glides: Add \$8.00 net per chair for a set of four (4).

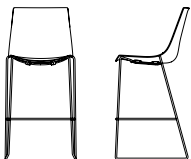

**Amadeus Bar Chair  
Sled Base**

	MODEL	LIST PRICE/ GRADE	COM/ COL	A	B	C	D	E	F	G	H	I	J	K	L
3D Walnut veneer shell upholstered seat onlay	AMBS-3WU	Powder Coat	\$1665	1710	1732	1754	1776	1800	1821	1844	1866	1888	1910	1933	1955
		Chrome	\$1731	1775	1798	1820	1841	1865	1887	1909	1932	1954	1976	2000	2021

W 21 D 21.5 H 44 SH 30

COM Yardage: 1 or 2 seats: .75 yard  
Contact Leland Customer Experience for yardage requirements on textiles with repeats.  
For COL requirements please contact Leland Customer Experience.  
Optional Glides: Add \$8.00 net per chair for a set of four (4).

**To specify:  
Please refer to pages 3-4 for  
complete specifying information.  
Specify all products by their  
product code.**

AMADEUS BAR CHAIR, WOOD BASE  
Design: Martin Ballendat

AM19



**Amadeus Bar Chair**

**Wood Base**

	MODEL	FRAME FINISH	LIST PRICE
Polypropylene shell	AMBW-PO		\$1342
W 20 D 22.5 H 44 SH 29		Optional Glides: Add \$8.00 net per chair for a set of four (4).	



**Amadeus Bar Chair**

**Wood Base**

	MODEL	LIST PRICE/ GRADE	COM/ COL	A	B	C	D	E	F	G	H	I	J	K	L
Polypropylene shell upholstered seat onlay	AMBW-PU		\$1472	1514	1535	1555	1577	1597	1618	1639	1660	1680	1702	1722	1742
W 20 D 22.5 H 44 SH 29.5		COM Yardage: 1 or 2 seats: .75 yard Contact Leland Customer Experience for yardage requirements on textiles with repeats. Optional Glides: Add \$8.00 net per chair for a set of four (4)													

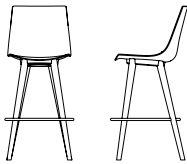

**Amadeus Bar Chair**

**Wood Base**

	MODEL	LIST PRICE/ GRADE	COM/ COL	A	B	C	D	E	F	G	H	I	J	K	L
Fully upholstered	AMBW-FU		\$1773	1866	1914	1960	2007	2054	2102	2148	2195	2242	2290	2336	2382
W 20 D 22.5 H 44 SH 29.5		COM Yardage: 1 seat: 1.5 yards Contact Leland Customer Experience for yardage requirements on textiles with repeats. Optional Glides: Add \$8.00 net per chair for a set of four (4)													

To specify:  
Please refer to pages 3-4 for  
complete specifying information.  
Specify all products by their  
product code.

Pricing Effective: February 2022

AMADEUS BAR CHAIR, WOOD BASE  
Design: Martin Ballendat

AM20



**Amadeus Bar Chair**

**Wood Base**

	MODEL	FRAME FINISH	LIST PRICE
3D beech veneer shell	AMBW-3DB		\$2183
W 20 D 22.5 H 44 SH 29		Optional Glides: Add \$8.00 net per chair for a set of four (4).	

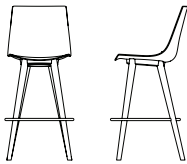

**Amadeus Bar Chair**

**Wood Base**

	MODEL	LIST PRICE/ GRADE	COM/ COL	A	B	C	D	E	F	G	H	I	J	K	L
3D beech veneer shell upholstered seat onlay	AMBW-3BU	\$2324		2368	2391	2413	2435	2459	2480	2503	2525	2548	2569	2592	2614
W 20 D 22.5 H 44 SH 29.5		COM Yardage: 1 or 2 seats: .75 yard Contact Leland Customer Experience for yardage requirements on textiles with repeats. Optional Glides: Add \$8.00 net per chair for a set of four (4)													



**Amadeus Bar Chair**

**Wood Base**

	MODEL	FRAME FINISH	LIST PRICE
3D american walnut veneer shell	AMBW-3DW		\$2511
W 20 D 22.5 H 44 SH 29		Optional Glides: Add \$8.00 net per chair for a set of four (4).	



**Amadeus Bar Chair**

**Wood Base**

	MODEL	LIST PRICE/ GRADE	COM/ COL	A	B	C	D	E	F	G	H	I	J	K	L
3D american walnut veneer shell, upholstered seat onlay	AMBW-3WU	\$2652		2697	2719	2740	2764	2785	2808	2829	2853	2875	2897	2920	2942
W 20 D 22.5 H 44 SH 29.5		COM Yardage: 1 or 2 seats: .75 yard Contact Leland Customer Experience for yardage requirements on textiles with repeats. Optional Glides: Add \$8.00 net per chair for a set of four (4)													

To specify:

Please refer to pages 3-4 for complete specifying information. Specify all products by their product code.

Pricing Effective: February 2022

# AMADEUS TRANSPORT/STACKING DOLLY

Design: Martin Ballendat

# AM21

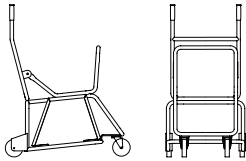

## Amadeus

### Sled Base

#### Transport/Stacking Dolly

MODEL

FRAME FINISH

LIST PRICE

Black powder coat finish

AMD-SB

\$757

W 23.5 D37.5 H 43  
(Dimensions of dolly when empty)

Sled Base: 20 high on dolly (15 high on floor)

Weight with 20 high on dolly: 470 lbs

For use with all Amadeus sled base, side chairs with poly shells, wood shells, and upholstered onlay

\*\*Arm, Counter, & Bar models do not stack

W 23.5 D37.5 H 70  
(Dimensions with 20 poly or wood shell chairs stacked)

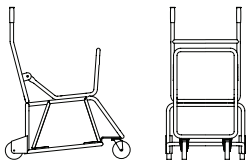

## Amadeus

### Four Leg Base

#### Transport/Stacking Dolly

MODEL

FRAME FINISH

LIST PRICE

Black powder coat finish

AMD-4L

\$1078

W 23.5 D37.5 H 43  
(Dimensions of dolly when empty)

Four Leg Base: 12 high on dolly

Weight with 12 high on dolly: 350 lbs

For use with all shell types

\*\*Arm, Counter, & Bar models do not stack

W 23.5 D37.5 H 65  
(Dimensions with 12 poly or wood shell chairs stacked )

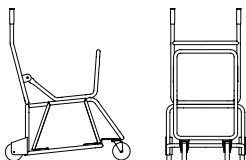

## Amadeus

### Sled Base, Fully Upholstered

#### Transport/Stacking Dolly

MODEL

FRAME FINISH

LIST PRICE

Black powder coat finish

AMD-SBFU

\$1334

W 23.5 D37.5 H 78  
(Dimensions with 20 fully upholstered chairs stacked)

Sled Base: 20 high on dolly (15 high on floor)

Weight with 20 high on dolly: 530 lbs

For use with fully upholstered shell only

\*\*Arm, Counter, & Bar models do not stack

To specify:

Please refer to pages 3-4 for complete specifying information.

Specify all products by their product code.

Pricing Effective: February 2022

---

**5695 Eagle Drive, SE  
Grand Rapids,  
Michigan 49512  
616-975-9260  
lelandfurniture.com**

---

**5695 Eagle Drive, SE**  
**Grand Rapids,**  
**Michigan 49512**  
**616-975-9260**  
**[lelandfurniture.com](http://lelandfurniture.com)**



freshcoast collection  
**BEACH STONES**

2022 Price List

Pricing Effective July 2022



freshcoast  
by LELAND

**beach stones price list**

---

+ beach stones: table of contents.....	BSC2
+ beach stones specification information .....	BSC3
+ beach stones specification example.....	BSC4
+ beach stones seating .....	BSC5
+ beach stone table.....	BSC6

## model

DESCRIPTION	CODE
Beach Stone E	BSE
Beach Stone F	BSF
Beach Stone G	BSG
Beach Stone H	BSH
Beach Stone I	BSI
Beach Stone J	BSJ
Beach Stone K	BSK
Beach Stone L	BSL

## upholstery selection

Please refer to freshcoast Textile Program which features textiles and leathers from the following partners:

- Camira
- Carnegie
- CF Stinson
- Green Hides
- Maharam
- Unika Vaev

The complete grade list can be found at [www.fc.studio/textile-partners](http://www.fc.studio/textile-partners) or you can specify COM/COL. Due to the design of this product, it is recommended that all non pre-approved textile be tested for compatibility.

Contact freshcoast for yardage requirements on textiles with repeats.

## base finish

Black textured powder coat

## table top finish

### LAMINATE

DESCRIPTION	CODE
Black Laminate	LBK
White Laminate	LWH

### SOLID SURFACE

DESCRIPTION	CODE
Black Corian®	CB
White Corian®	CW
Grey Corian®	CG

### GLASS

DESCRIPTION	CODE
Black Back painted Glass	BG
White Back painted Glass	WG

## product weights

DESCRIPTION	LBS
Beach Stone E - BSE	50
Beach Stone F - BSF	50
Beach Stone G - BSG	50
Beach Stone H - BSH	50
Beach Stone I - BSI	50
Beach Stone J - BSJ	50
Beach Stone K - BSK	50
Beach Stone L - BSL	50

SPECIFICATIONS REQUIRED TO CREATE THE PRODUCT CODE

---

- + Model
- + Upholstery Selection
- + Table Top Finish (when applicable)



model

---

Beach Stone E (BSE)

upholstery selection  
Upholstered (COM)



TABLE TOP FINISH  
When applicable

seating



beach stone e	model	com/col	a	b	c	d	e	f	g	h	i	j	k	l
<b>fully upholstered</b>	BSE	\$1398	1564	1647	1731	1814	1897	1980	2063	2146	2229	2312	2396	2479
W32 D24 H25 SH18		COM yardage: 2.5 yds. Contact freshcoast customer care for COL requirements, textile testing requirements and yardage requirements for textiles with repeats.												



beach stone F	model	com/col	a	b	c	d	e	f	g	h	i	j	k	l
<b>fully upholstered</b>	BSF	\$1375	1541	1624	1708	1791	1874	1957	2040	2123	2206	2289	2373	2456
W32 D24 H26 SH18		COM yardage: 2.5 yds. Contact freshcoast customer care for COL requirements, textile testing requirements and yardage requirements for textiles with repeats.												



beach stone G	model	com/col	a	b	c	d	e	f	g	h	i	j	k	l
<b>fully upholstered</b>	BSG	\$1392	1559	1642	1725	1808	1891	1974	2057	2140	2224	2307	2390	2473
W32 D24 H31 SH18		COM yardage: 2.5 yds. Contact freshcoast customer care for COL requirements, textile testing requirements and yardage requirements for textiles with repeats.												



beach stone H	model	com/col	a	b	c	d	e	f	g	h	i	j	k	l
<b>fully upholstered</b>	BSH	\$927	1093	1176	1260	1343	1426	1509	1592	1675	1758	1841	1925	2008
W48 D18 H18		COM yardage: 2.5 yds. Contact freshcoast customer care for COL requirements, textile testing requirements and yardage requirements for textiles with repeats.												



beach stone I	model	com/col	a	b	c	d	e	f	g	h	i	j	k	l
<b>fully upholstered</b>	BSI	\$835	946	1001	1056	1112	1167	1223	1278	1333	1389	1444	1500	1555
W33 D22 H18		COM yardage: 1.75 yds. Contact freshcoast customer care for COL requirements, textile testing requirements and yardage requirements for textiles with repeats.												

to specify: please refer to pages 3-4 for complete specifying information. Specify all products by their product code.

tables

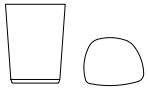

beach stone J	model	top finish	com/col	a	b	c	d	e	f	g	h	i	j	k	l
upholstered w/ table	BSJ	Laminate	\$976	1031	1059	1086	1114	1142	1170	1197	1225	1253	1280	1308	1336
		Corian	\$1464	1547	1589	1629	1671	1713	1755	1796	1838	1880	1920	1962	2004

W17 D13 H22

COM yardage: 1 yd.

Contact freshcoast customer care for COL requirements, textile testing requirements and yardage requirements for textiles with repeats.

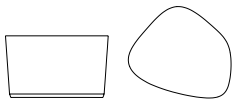

beach stone K	model	top finish	com/col	a	b	c	d	e	f	g	h	i	j	k	l
upholstered w/ table	BSK	Laminate	\$976	1086	1142	1197	1253	1308	1363	1419	1474	1530	1585	1641	1696
		Corian	\$1464	1629	1713	1796	1880	1962	2045	2129	2211	2295	2378	2462	2544

W30 D27 H18

COM yardage: 2 yds.

Contact freshcoast customer care for COL requirements, textile testing requirements and yardage requirements for textiles with repeats.

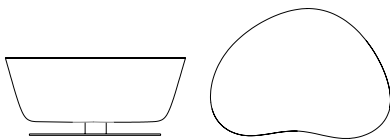

beach stone L	model	top finish	com/col	a	b	c	d	e	f	g	h	i	j	k	l
upholstered w/ table	BSL	Laminate	\$3053	3219	3302	3385	3468	3551	3634	3717	3801	3884	3967	4050	4133
		Corian	\$4580	4829	4953	5078	5202	5327	5451	5576	5702	5826	5951	6075	6200

W47 D34 H20

COM yardage: 3 yds.

Contact freshcoast customer care for COL requirements, textile testing requirements and yardage requirements for textiles with repeats.

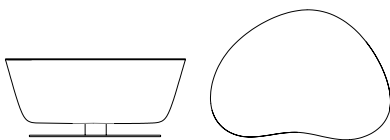

beach stone L	model	com/col	a	b	c	d	e	f	g	h	i	j	k	l
upholstered w/ backpainted glass	BSL	\$3331	3497	3580	3663	3746	3829	3913	3996	4079	4162	4245	4328	4411

W47 D34 H20

COM yardage: 3 yds.

Contact freshcoast customer care for COL requirements, textile testing requirements and yardage requirements for textiles with repeats.

to specify: please refer to pages 3-4 for complete specifying information. Specify all products by their product code.

# Brit Bench Metallic

## February 2022 Price List

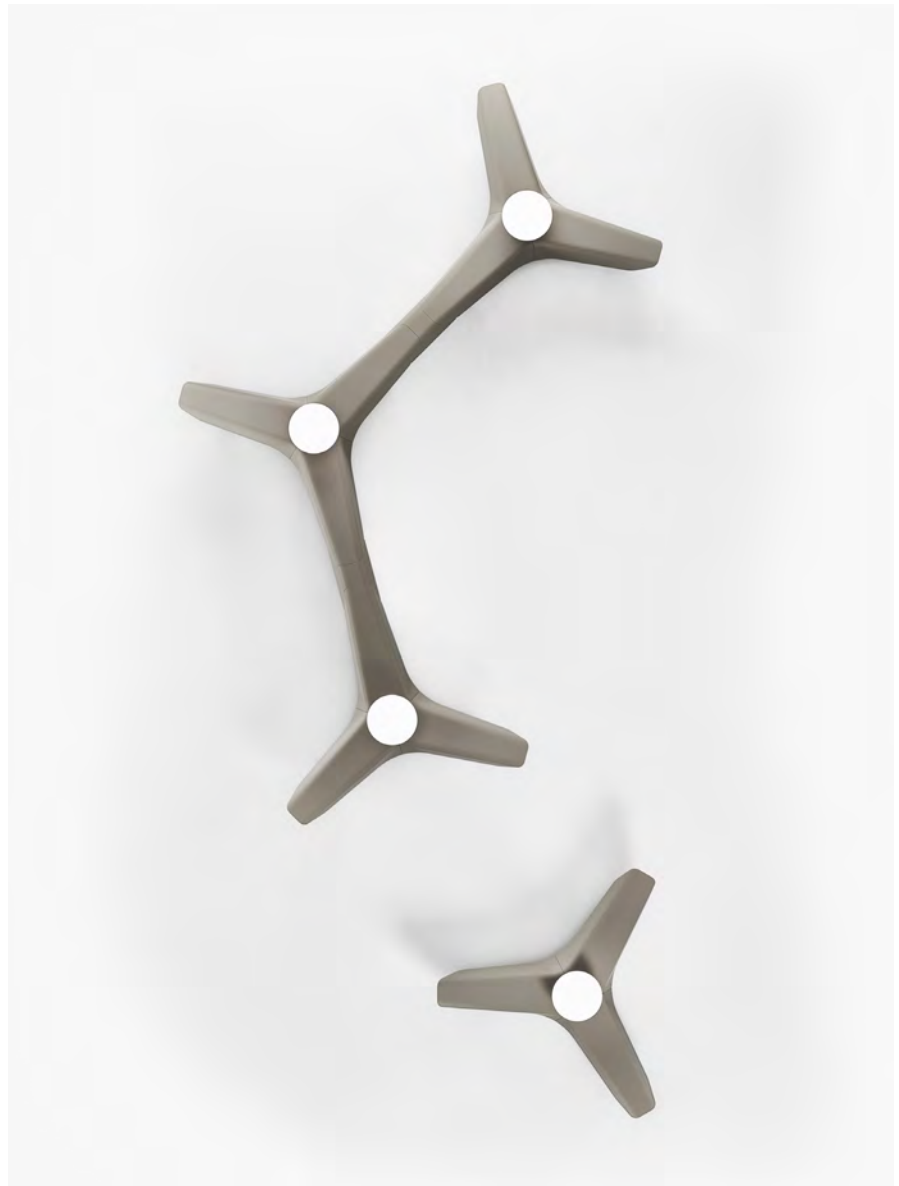

# Brit Bench Metallic

Table of Contents	BBM2
Specification Information	BBM3
Specification Example	BBM4
Powder Coat Steel, Upholstered Seat Onlay	BBM5
Auxiliary Options	BBM6
Link Specification Information	BBM7
Link Specification Example	BBM8
Brit Bench Metallic Link	BBM9
Auxiliary Options	BBM10



## Bench Model

DESCRIPTION	CODE
Brit Bench metallic powder coat steel	BBPC
Brit Bench metallic powder coat steel, with powder coat steel table	BBPCT
Brit Bench metallic powder coat steel, upholstered onlay	BBPCU with
Brit Bench metallic powder coat steel, with powder steel table, with upholstered onlay	BBPCTU coat

## Leg Finish

DESCRIPTION	CODE
Brushed Stainless Steel	BSS
Black Powder Coat	BPC

## Powder Coat Steel Finish

DESCRIPTION	CODE
Black Textured Powder Coat	BT
Grey Textured Powder Coat	GT
Soda Red Textured	SRT
Dolphin Textured	DLT
Oxford Textured	OXT
Tangerine Textured	TNT
Ice Blue Textured	IBT
Artic Textured	ART
Caribbean Textured	CBT
Limelight Textured	LLT
Ink Textured	IN

## Upholstered Onlay Selection

Please refer to Leland Textile Program which features textiles and leathers from the following partners:

- Camira
- Carnegie
- CF Stinson
- Green Hides
- Maharam
- Unika Vaev

The complete grade list can be found on our website or you can specify COM/COL. Due to the design of this product, it is recommended that all non pre-approved textile be tested for compatibility.

Upholstered onlay is not an option for the Brit Bench Metallic link.

## Table Top Surface

DESCRIPTION	CODE
Corian® Solid Surface Solid with 0.5" square edge	SSS

Contact Corian® Solid Surface for current solid and pattern availability. A custom quote is required for all solid surface. Please contact Leland Customer Experience to request a custom quote.

## Auxiliary Options

DESCRIPTION	CODE
Brit Bench Electrical outlets, (with table)	BBE0
Brit Bench Floor Mount	BBFM
Brit Bench Security Pan	BSP
Outdoor Treatment	OT

## Glides

Brit Bench glides are nylon.

## Product Specification

Brit Bench product layout is required at the quotation stage and order stage to ensure accurate product specifications. Contact Leland Customer Experience for CAD symbols.

## Shipment Detail

Please note that Brit Bench products will be shipped unassembled. Please contact Customer Experience if assembled shipment is desired as additional charges will apply.

**Specifications required to create the product code**

**BRIT BENCH METALLIC (WITHOUT TABLE)**

- Model
- Leg Finish
- Powder Coat Steel Finish (when applicable)
- Upholstery Selection (when applicable)
- Auxiliary Options (when applicable)



**BRIT BENCH METALLIC (WITH TABLE)**

- Model
- Leg Finish
- Powder Coat Steel Finish (when applicable)
- Upholstered Onlay Selection (when applicable)
- Table Top Surface
- Surface Color (when applicable)
- Auxiliary Options (when applicable)



**MODEL**

Brit Bench Metallic Powder Coat Steel, with Powder Coat Steel Table (BBPCT)

**LEG FINISH**

Brushed Stainless Steel (BPC)

**POWDER COAT STEEL FINISH**

Soda Red Textured (SRT)

**UPHOLSTERED ONLAY SELECTION**

When applicable, enter upholstery grade, COM or COL

**TABLE TOP SURFACE**

SSS

**TOP SURFACE COLOR**

Corian® White Solid Surface (CW)

**AUXILIARY OPTIONS**

When applicable, enter auxiliary option code

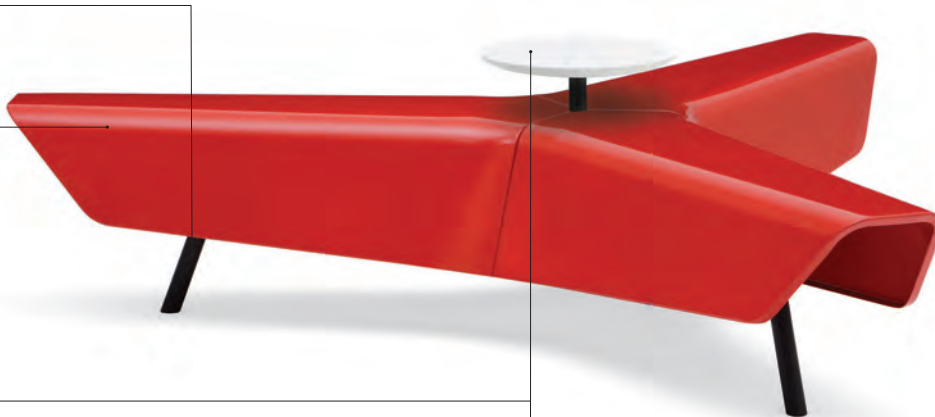

**BRIT BENCH METALLIC POWDER COAT STEEL**  
Design: Simon Pengelly

**BBM5**



<b>Brit Bench Metallic</b>	<b>MODEL</b>	<b>LIST PRICE</b>
Powder coat steel	BBPC 1-3 units	\$9173
W 81 SH 18.5	BBPC 4+ units	\$7901

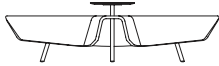

<b>Brit Bench Metallic</b>	<b>MODEL</b>	<b>LIST PRICE</b>
Powder coat steel, table	BBPCT 1-3 units	\$10530
W 81 SH 18.5	BBPCT 4+ units	\$9256

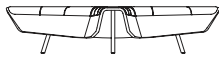

<b>Brit Bench Metallic</b>	<b>MODEL</b>	<b>LIST PRICE/GRADE</b>	<b>COM/ COL</b>	<b>A</b>	<b>B</b>	<b>C</b>	<b>D</b>	<b>E</b>	<b>F</b>	<b>G</b>	<b>H</b>	<b>I</b>	<b>J</b>	<b>K</b>	<b>L</b>
Powder coat steel upholstered seat onlay	BBPCU 1-3 units	\$ 9816	10097	10241	10381	10523	10666	10807	10949	11091	11233	11374	11517	11658	
	BBPCU 4+ units	\$ 8542	8825	8966	9108	9250	9392	9533	9676	9817	9959	10102	10243	10385	

W 81 SH 19.5

COM Yardage: 1 bench: 4 yards  
For COL requirements please contact Leland Customer Experience.



<b>Brit Bench Metallic</b>	<b>MODEL</b>	<b>LIST PRICE/ GRADE</b>	<b>COM/ COL</b>	<b>A</b>	<b>B</b>	<b>C</b>	<b>D</b>	<b>E</b>	<b>F</b>	<b>G</b>	<b>H</b>	<b>I</b>	<b>J</b>	<b>K</b>	<b>L</b>
Powder coat steel, table upholstered seat onlay	BBPCTU 1-3 units	\$ 11169	11452	11594	11737	11878	12020	12162	12304	12445	12588	12729	12871	13012	
	BBPCTU 4+ units	\$ 9898	10180	10321	10464	10605	10747	10890	11030	11172	11314	11456	11597	11740	

W 81 SH 19.5

COM Yardage: 1 bench: 4 yards  
For COL requirements please contact Leland Customer Experience.

<b>Brit Bench Table Top</b>	<b>MODEL</b>
Corian® Solid Surface Circular Top	SSS

Contact Corian® Solid Surface for current solid and pattern availability. A custom quote is required for all solid surface. Please contact Leland Customer Experience to request a custom quote.

**To specify:**  
Please refer to pages 3-4 for complete specifying information. Specify all products by their product code.

**Pricing Effective: February 2022**

# BRIT BENCH METALLIC AUXILIARY OPTIONS

Design: Simon Pengelly

# BBM6

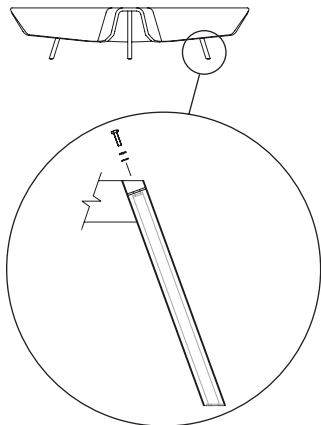

Brit Bench Floor Mount	MODEL	LIST PRICE
	BBFM	\$191
<p>Due to the variety of floor surfaces on which the Brit Bench may be installed, floor mount fasteners are not supplied by Leland International. The Brit Bench floor mount feature consists of legs with floor mount brackets designed to use .3125 thread diameter fasteners. Responsibility of fastener choice is the customers. Brit Bench Floor Mount must be specified at the time of purchasing. The Floor Mount cannot be added later in the field.</p>		

Brit Bench Security Pan	MODEL	LIST PRICE
	BBSP	\$1601

Brit Bench Electrical Outlet	MODEL	LIST PRICE
For table	BBEO	\$1060
<p>Brit Bench electrical outlet option is not standard for all Brit Bench tables. Electrical outlet is located under the table edge, therefore a Brit Bench with table must be specified when specifying electrical outlet option. Brit Bench electrical outlet option features one 120v AC receptacle.</p>		

Outdoor Treatment	MODEL	LIST PRICE
powder coat steel bench	OT	\$353

**To specify:**  
 Please refer to pages 3-4 for complete specifying information.  
 Specify all products by their product code.

## Link Model

---

DESCRIPTION	CODE
Brit Bench Metallic Link powder coat steel	BBLPC

## Powder Coat Steel Finish

---

DESCRIPTION	CODE
White Textured Powder Coat	WT
Black Textured Powder Coat	BT
Grey Textured Powder Coat	GT
Soda Red Textured	SRT
Dolphin Textured	DLT
Oxford Textured	OXT
Tangerine Textured	TNT
Ice Blue Textured	IBT
Artic Textured	ART
Caribbean Textured	CBT
Limelight Textured	LLT
Ink Textured	IN

## Auxiliary Options

---

DESCRIPTION	CODE	DESCRIPTION	CODE
Brit Bench Link Security Pan			BBLSP
Outdoor Treatment			OT

## Product Specification

---

Brit Bench product layout is required at the quotation stage and order stage to ensure accurate product specifications. Contact Leland Customer Experience for CAD symbols.

## Shipment Details

---

Please note that Brit Bench products will be shipped unassembled.  
Please contact Customer Experience if assembled shipment is desired as additional charges will apply.

**Specifications required to create the product code**

- Model
- Powder Coat Steel Finish (when applicable)
- Upholstery Selection (when applicable)
- Outdoor Treatment (when applicable)
- Auxiliary Options (when applicable)



**MODEL**

Brit Bench Metallic Link Powder Coat Steel (BBLPC)

**POWDER COAT STEEL FINISH**

Artic Textured (ART)

**OUTDOOR TREATMENT**

When applicable

**AUXILIARY OPTIONS**

When applicable, enter auxiliary option code

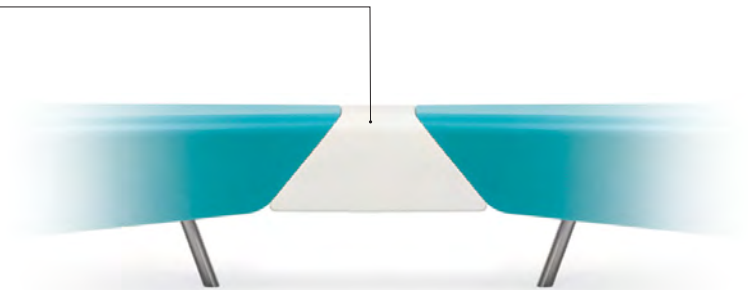

**BRIT BENCH METALLIC LINK**  
Design: Simon Pengelly

# BBM9

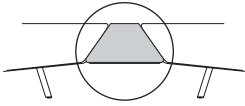

<b>Brit Bench Metallic Link</b>	<b>MODEL</b>	<b>FRAME FINISH</b>	<b>LIST PRICE</b>
powder coat steel link	BBLPC		\$1076

W 7.875

Upholstered onlay is not an option for the Brit Bench Metallic Powder Coat Steel Link.

**To specify:**  
Please refer to pages 3-4 for complete specifying information.  
Specify all products by their product code.

**Pricing Effective: February 2022**

<b>Brit Bench Link Security Pan</b>	<b>MODEL</b>	<b>FRAME FINISH</b>	<b>LIST PRICE</b>
	BBLSP		\$360

Brit Bench Link Security Pan must be specified at the time of purchasing.  
The Link Security Pan cannot be added later in the field.

<b>Outdoor Treatment</b>	<b>MODEL</b>	<b>FRAME FINISH</b>	<b>LIST PRICE</b>
powder coat steel link	OT		\$118

To specify:  
Please refer to pages 3-4 for  
complete specifying information.  
Specify all products by their  
product code.



---

**5695 Eagle Drive, SE  
Grand Rapids,  
Michigan 49512  
616-975-9260  
lelandfurniture.com**

# Café Parfait

## February 2022 Price List



# Café Parfait

Table of Contents	CP2
Specification Information	CP3
Specification Example	CP4
Side Chair	CP5
Counter Chair	CP6
Bar Chair	CP7
Transport/Stacking Dolly	CP8

**Chair Model**

DESCRIPTION	CODE
Café Parfait side chair, upholstered seat, wood back	CPSUW
Café Parfait side chair, wood seat, wood back	CPSWW
Café Parfait counter chair, upholstered seat, wood back	CPCUW
Café Parfait counter chair, wood seat, wood back	CPCWW
Café Parfait bar chair, upholstered seat, wood back	CPBUW
Café Parfait bar chair, wood seat, wood back	CPBWW

**Upholstery Selection****POLYPROPYLENE SHELL:**

Please refer to Leland Textile Program which features textiles and leathers from the following partners:

- Camira
- Green Hides
- Carnegie
- Maharam
- CF Stinson
- Unika Vaev

The complete grade list can be found on our website or you can specify COM/COL. Due to the design of this product, it is recommended that all non pre-approved textile be tested for compatibility.

**Seat and Back Wood Finish****STANDARD LELAND COLORS**

**CUSTOM** Specify Custom (01)

\*Please note that Café Parfait is NOT AVAILABLE in the following finishes:

Natural Walnut Matte (08M), Natural Beech (09), Natural White Oak Matte (12M)

**Frame Finishes**

DESCRIPTION	CODE
Sterling	ST
Warm Grey	WG
Cool Grey	CG
Black	B
White	W
Matte Gold Rush	MGR
Matte Mercury	MMR
Matte Mineral	MMN
Matte Burnish	MBN
Matte Foundry	MFN

**TEXTURED**

DESCRIPTION	CODE
Soda Red Textured	SRT
Dolphin Textured	DLT
Oxford Textured	OXT
Tangerine Textured	TNT
Ice Blue Textured	IBT
Artic Textured	ART
Caribbean Textured	CBT
Limelight Textured	LLT
Ink Textured	INT

**Glide Type****STANDARD:**

DESCRIPTION	CODE
Nylon	S

**OPTIONAL:**

DESCRIPTION	CODE
Felt	FC
Floor Saver™ (for VCT type floors)	FS
Metal	M
Rubber	R

Please note that optional glides raise the chair height .5 inch.

**Specifications required to create the product code**

- Model
- Seat Upholstery or Finish
- Back Finish
- Frame Finish
- Glide Type

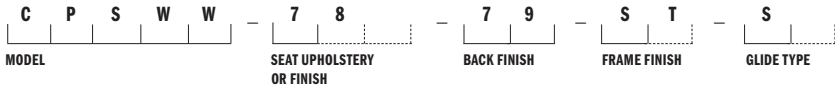

**MODEL**

Café Parfait Side Chair -  
wood seat, wood back  
(CPSWW)

**SEAT UPHOLSTERY OR FINISH**

Aegean (78)

**BACK FINISH**

Sea Grass (79)

**FRAME FINISH**

Sterling (ST)



CAFÉ PARFAIT SIDE CHAIR  
 Design: Leland Design Group

CP5



Café Parfait Side Chair	MODEL	LIST PRICE
Wood seat wood back,	CPSWW	\$632

W 19 D 20 H 31 SH 19

Optional Glides: Add \$8.00 net per chair for a set of four (4). Optional Glides raise chair height .5 inch.



Café Parfait Side Chair	MODEL	LIST PRICE/GRADE	COM/COL	A	B	C	D	E	F	G	H	I	J	K	L
3D Beech veneer shell, upholstered seat onlay	CPSUW		\$589	619	636	652	669	685	703	719	736	752	769	785	802

W 19 D 20 H 31 SH 19

Optional Glides: Add \$8.00 net per chair for a set of four (4). Optional Glides raise chair height .5 inch.  
 COM Yardage: 1 or 2 seats: .75 yard; 3 or 4 seats: 1.25 yards  
 Contact Leland Customer Experience for yardage requirements on textiles with repeats.  
 For COL requirements please contact Leland Customer Experience.

To specify:  
 Please refer to pages 3-4 for  
 complete specifying information.  
 Specify all products by their  
 product code.

**CAFÉ PARFAIT COUNTER CHAIR**  
 Design: Leland Design Group

**CP6**

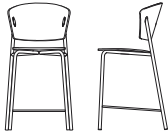

<b>Café Parfait Counter Chair</b>	<b>MODEL</b>	<b>LIST PRICE</b>
Wood seat wood back,	CPCWW	\$874

W 18.5 D 23 H 37.75 SH 25

Optional Glides: Add \$8.00 net per chair for a set of four (4). Optional Glides raise chair height .5 inch.

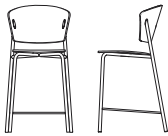

<b>Café Parfait Counter Chair</b>	<b>MODEL</b>	<b>LIST PRICE/GRADE</b>	<b>COM/COL</b>	<b>A</b>	<b>B</b>	<b>C</b>	<b>D</b>	<b>E</b>	<b>F</b>	<b>G</b>	<b>H</b>	<b>I</b>	<b>J</b>	<b>K</b>	<b>L</b>
3D Beech veneer shell, upholstered seat onlay	CPCUW		\$835	864	881	897	914	930	947	964	981	997	1014	1030	1047

W 18.5 D 23 H 37.75  
 SH 25.5

Optional Glides: Add \$8.00 net per chair for a set of four (4). Optional Glides raise chair height .5 inch.  
 COM Yardage: 1 or 2 seats: .75 yard; 3 or 4 seats: 1.25 yards  
 Contact Leland Customer Experience for yardage requirements on textiles with repeats.  
 For COL requirements please contact Leland Customer Experience.

**To specify:**  
 Please refer to pages 3-4 for  
 complete specifying information.  
 Specify all products by their  
 product code.

**Pricing Effective: February 2022**

**CAFÉ PARFAIT BAR CHAIR**  
 Design: Leland Design Group

**CP7**

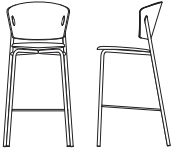

<b>Café Parfait Bar Chair</b>	<b>MODEL</b>	<b>LIST PRICE</b>
Wood seat wood back,  W 19 D 20 H 43 SH 29.5	CPBWW	\$893

Optional Glides: Add \$8.00 net per chair for a set of four (4). Optional Glides raise chair height .5 inch.

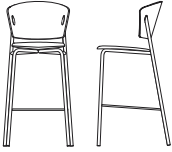

<b>Café Parfait Bar Chair</b>	<b>MODEL</b>	<b>LIST PRICE/GRADE</b>	<b>COM/COL</b>	<b>A</b>	<b>B</b>	<b>C</b>	<b>D</b>	<b>E</b>	<b>F</b>	<b>G</b>	<b>H</b>	<b>I</b>	<b>J</b>	<b>K</b>	<b>L</b>
3D Beech veneer shell, upholstered seat onlay  W 19 D 20 H 43 SH 30	CPBUW		\$851	881	897	914	930	947	964	981	997	1014	1030	1047	1063

Optional Glides: Add \$8.00 net per chair for a set of four (4). Optional Glides raise chair height .5 inch.  
 COM Yardage: 1 or 2 seats: .75 yard; 3 or 4 seats: 1.25 yards  
 Contact Leland Customer Experience for yardage requirements on textiles with repeats.  
 For COL requirements please contact Leland Customer Experience.

**To specify:**  
 Please refer to pages 3-4 for  
 complete specifying information.  
 Specify all products by their  
 product code.

**Pricing Effective: February 2022**



CAFÉ PARFAIT TRANSPORT/STACKING DOLLY  
Design: Leland Design Group

CP8

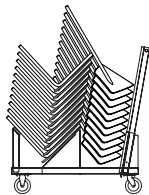

**Café Parfait Transport/  
Stacking Dolly**

	MODEL		LIST PRICE
W 19 D 43 H 45 (Empty)	CPD	Black Finish	\$942
W 19 D 43 H 67 (With 10 side chairs)		Café Parfait Transport/Stacking Dolly handles up to 10 Café Parfait side chairs.	

To specify:

Please refer to pages 3-4 for  
complete specifying information.

Specify all products by their  
product code.

Pricing Effective: February 2022

---

**5695 Eagle Drive, SE**  
**Grand Rapids,**  
**Michigan 49512**  
**616-975-9260**  
**[lelandfurniture.com](http://lelandfurniture.com)**

# Cambre Table

## February 2022 Price List

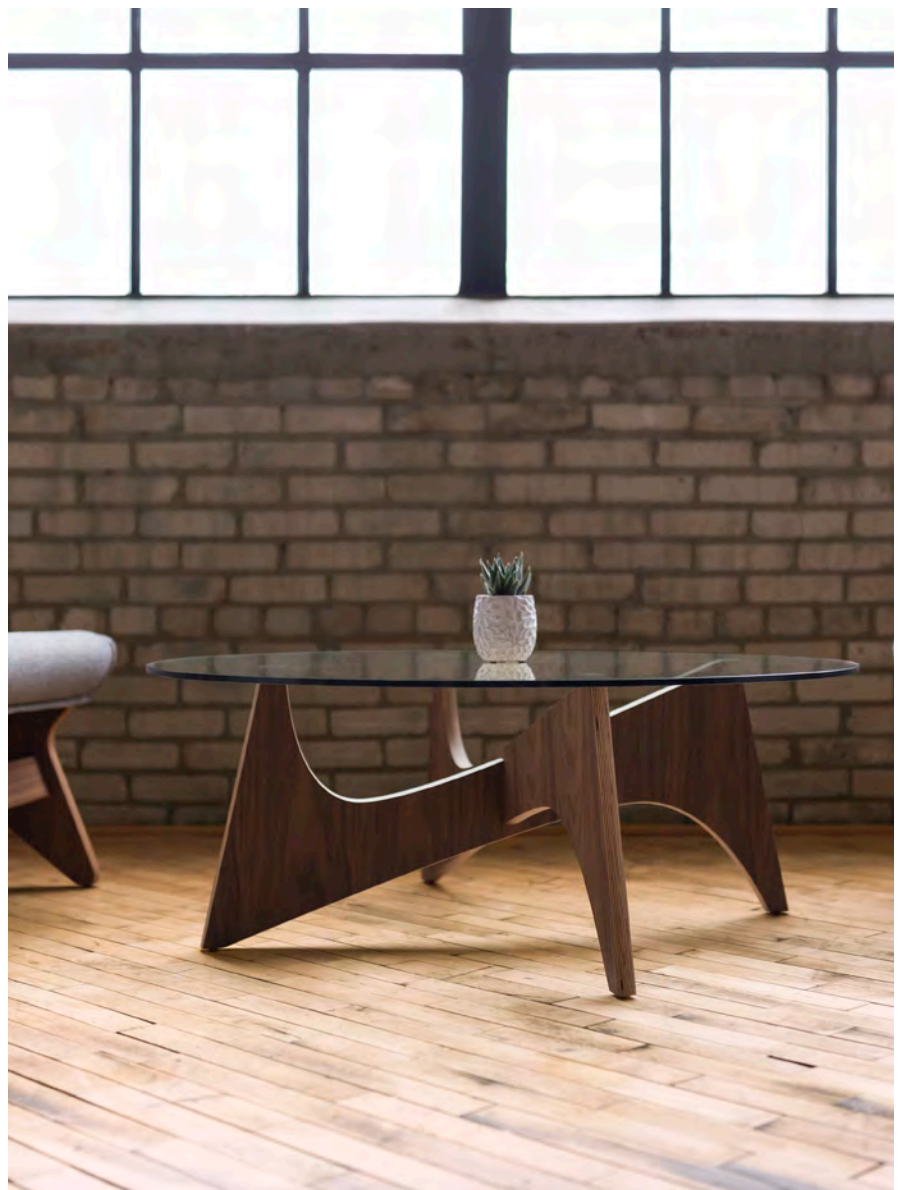

# Cambre Table

Table of Contents	CA2
Specification Information	CA3
Specification Example	CA4
Table 16"	CA5
Table 22"	CA5

**Table Model**

DESCRIPTION	CODE
Cambre Table	CA

**Table Height**

DESCRIPTION	CODE
16"	16H
22"	22H

**Base Finish**

DESCRIPTION	CODE
Natural Walnut	08M
Natural Ash	07M

Maple in Standard Leland Colors

**LELAND COLORS****Top Size**

DESCRIPTION	CODE
16" H Table	
42" Round	42D
34" Square	3434
22" H Table	
18" Round	18D
16" Square	1616

**Top Surface Option**

DESCRIPTION	CODE
16" H Table	
Clear Glass	G
22" H Table	
Clear Glass	G

**Glide Selection**

DESCRIPTION	CODE
Nylon (standard)	S
Felt	F

**Specifications required to create the product code**

- Model
- Table Height
- Base Finish Selection
- Top Size
- Top Surface
- Glide Selection

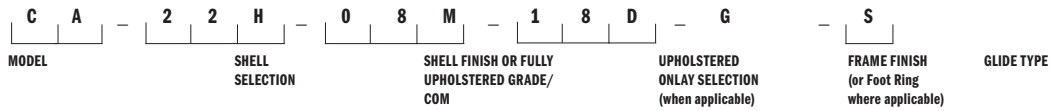

**MODEL**

Cambre Table (CA)

**TABLE HEIGHT**

22" (22H)

**BASE FINISH**

Natural Walnut (08M)

**TOP SIZE**

18" Round (18D)

**TOP SURFACE**

Glass (G)

**GLIDE SELECTION**

Nylon (S)



**CAMBRE TABLE**  
Design: Bruce Sienkowski

**CA5**

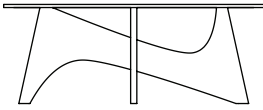

<b>Cambre</b>	<b>MODEL</b>	<b>CLEAR GLASS</b>
Cambre Occasional Table, 42" Round Top	CA-16H-42D	\$2132
W 42 D 42 H 16	Optional Glides: Add \$8.00 net per chair for a set of four (4).	

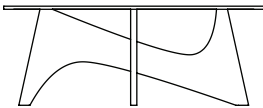

<b>Cambre</b>	<b>MODEL</b>	<b>CLEAR GLASS</b>
Cambre Occasional Table, 34" Square Top	CA-16H-3434	\$1686
W 34 D 34 H 16	Optional Glides: Add \$8.00 net per chair for a set of four (4).	

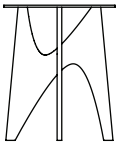

<b>Cambre</b>	<b>MODEL</b>	<b>CLEAR GLASS</b>
Cambre Side Table, 18" Round Top	CA-22H-18D	\$1699
W 18 D 18 H 22	Optional Glides: Add \$8.00 net per chair for a set of four (4).	

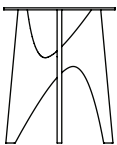

<b>Cambre</b>	<b>MODEL</b>	<b>CLEAR GLASS</b>
Cambre Side Table, 16" Square Top	CA-22H-1616	\$1339
W 16 D 16 H 22	Optional Glides: Add \$8.00 net per chair for a set of four (4).	

**To specify:**  
Please refer to pages 3-4 for complete specifying information. Specify all products by their product code.

---

**5695 Eagle Drive, SE  
Grand Rapids,  
Michigan 49512  
616-975-9260  
lelandfurniture.com**



# Ease

## February 2022 Price List



# Ease

Table of Contents	ES2
Specification Information	ES3
Specification Example	ES4
Side Chair	ES5
Transport/Stacking Dolly	ES7

**Chair Model**

DESCRIPTION	CODE
Ease side chair, upholstered seat, wood back	ESSUW
Ease side chair ganging, upholstered seat , wood back	ESSGUW
Ease side chair, upholstered seat, wood back upholstered back onlay	ESSUWU
Ease side chair ganging, upholstered seat wood back, upholstered back onlay	ESSGUWU
Ease side chair, wood seat, wood back	ESSWW
Ease side chair ganging, wood seat wood back	ESSGWW

**Seat and Back Wood Finish****STANDARD LELAND COLORS****CUSTOM** Specify Custom (01)

\*Please note that Ease is NOT AVAILABLE in the following finishes:

**Upholstery Selection**

Please refer to Leland Textile Program which features textiles and leathers from the following partners:

- Camira
- Carnegie
- CF Stinson
- Green Hides
- Maharam
- Unika Vaev

The complete grade list can be found on our website or you can specify COM/COL. Due to the design of this product, it is recommended that all non pre-approved textile be tested for compatibility.

**Frame Finish: Powdercoat and Chrome**

DESCRIPTION	CODE
Sterling	ST
Warm Grey	WG
Cool Grey	CG
Black	B
White	W
Matte Gold Rush	MGR
Matte Mercury	MMR
Matte Mineral	MMN
Matte Burnish	MBN
Matte Foundry	MFN
Chrome	C
Artic Textured	ART
Caribbean Textured	CBT
Limelight Textured	LLT
Ink Textured	INT

**Auxiliary Options****GLIDES**

DESCRIPTION	CODE
Polycarbonate	P
Felt	F

Please note that adding glides raises the chair height.25 inch.

**Specifications required to create the product code**

- Model
- Seat Upholstery or Finish
- Back Finish
- Upholstered Back Onlay (when applicable)
- Frame Finish
- Auxiliary Options (when applicable)



**MODEL**

Ease Side Chair, upholstered seat, wood back, upholstered back onlay (ESSUWU)

**SEAT UPHOLSTERY OR FINISH**

Grade H (H)

**BACK FINISH**

Natural (11)

**UPHOLSTERED BACK ONLAY**

Grade H (H)

**FRAME FINISH**

Chrome (C)



**EASE SIDE CHAIR**  
Design: Leland Design Group

**ES5**



**Ease Side Chair**

	MODEL	LIST PRICE/GRADE	COM/COL	A	B	C	D	E	F	G	H	I	J	K	L
Upholstered seat, wood back	ESSUW		\$567	597	613	629	645	660	676	692	707	723	739	754	770
W 19.5 D 21.75 H 31 SH 18.5															
Glides: Add \$8.00 net per chair for a set of four (4). COM Yardage: 1 or 2 seats: .75 yard, 3 or 4 seats: 1.5 yards, 5 or 6 seats: 2.25 yards. Contact Leland Customer Experience for yardage requirements on textiles with repeats. For COL requirements please contact Leland Customer Experience.															



**Ease Side Chair, Ganging**

	MODEL	LIST PRICE/GRADE	COM/COL	A	B	C	D	E	F	G	H	I	J	K	L
Upholstered seat, wood back	ESSGUW		\$613	643	659	675	690	706	722	738	753	769	785	800	816
W 19.5 D 21.75 H 31 SH 18.5															
Glides: Add \$8.00 net per chair for a set of four (4). COM Yardage: 1 or 2 seats: .75 yard, 3 or 4 seats: 1.5 yards, 5 or 6 seats: 2.25 yards. Contact Leland Customer Experience for yardage requirements on textiles with repeats. For COL requirements please contact Leland Customer Experience.															



**Ease Side Chair**

	MODEL	LIST PRICE/GRADE	COM/COL	A	B	C	D	E	F	G	H	I	J	K	L
Upholstered seat, wood back upholstered back onlay	ESSUWU		\$601	631	647	662	678	694	710	725	741	757	772	788	805
W 19.5 D 21.75 H 31 SH 18.5															
Glides: Add \$8.00 net per chair for a set of four (4). COM Yardage: 1 seat and back: .75 yard, 6 seats and backs: 3.5 yards Contact Leland Customer Experience for yardage requirements on textiles with repeats. For COL requirements please contact Leland Customer Experience.															



**Ease Side Chair, Ganging**

	MODEL	LIST PRICE/GRADE	COM/COL	A	B	C	D	E	F	G	H	I	J	K	L
Upholstered seat, wood back upholstered back onlay	ESSGUWU		\$712	742	758	773	790	806	822	837	853	869	884	900	916
W 19.5 D 21.75 H 31 SH 18.5															
Glides: Add \$8.00 net per chair for a set of four (4). COM Yardage: 1 seat and back: .75 yard, 6 seats and backs: 3.5 yards Contact Leland Customer Experience for yardage requirements on textiles with repeats. For COL requirements please contact Leland Customer Experience.															

To specify:

Please refer to pages 3-4 for complete specifying information.  
Specify all products by their product code.

Pricing Effective: February 2022

EASE SIDE CHAIR  
Design: Leland Design Group

ES6



<b>Ease Side Chair</b>	<b>MODEL</b>	<b>LIST PRICE</b>
Wood seat wood back,	ESSWW	\$582
W 19.5 D 21.75 H 31 SH 18	Glides: Add \$8.00 net per chair for a set of four (4).	



<b>Ease Side Chair, Ganging</b>	<b>MODEL</b>	<b>LIST PRICE</b>
Wood seat wood back,	ESSGWW	\$613
W 19.5 D 21.75 H 31 SH 18	Glides: Add \$8.00 net per chair for a set of four (4).	

To specify:  
Please refer to pages 3-4 for  
complete specifying information.  
Specify all products by their  
product code.

Pricing Effective: February 2022

EASE TRANSPORT/STACKING DOLLY  
Design: Leland Design Group

ES7

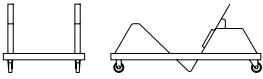

**Ease Transport/  
Stacking Dolly**

	MODEL	LIST PRICE
W 22.75 D 46.5 H 14.25 (empty)	ESSNDB	\$1005

Ease Transport/Stacking Dolly handles up to 25 side chairs in wood or 15 side chairs upholstered.

To specify:  
Please refer to pages 3-4 for  
complete specifying information.  
Specify all products by their  
product code.

Pricing Effective: February 2022

---

**5695 Eagle Drive, SE**  
**Grand Rapids,**  
**Michigan 49512**  
**616-975-9260**  
**[lelandfurniture.com](http://lelandfurniture.com)**



# Ebb Bench Fully Upholstered

February 2022 Price List



# Ebb Fully Upholstered

Table of Contents	EB2
Specification Information	EB3
Specification Example	EB4
Two Closed Ends	EB5
One Linking End	EB6
Two Linking Ends	EB7
Auxiliary Options	EB8
Hub Specification Information	EB9
Hub Specification Example	EB10
Hub	EB11
Hub Auxiliary Options	EB12
Pod Specification Information	EB13
Pod Specification Example	EB14
Pod	EB15
Pod Auxiliary Options	EB16

**Bench Model**

DESCRIPTION	CODE
Ebb fully upholstered bench, two closed ends	EBFUCC
Ebb fully upholstered bench, one linking end	EBFUCL
Ebb fully upholstered bench, two linking ends	EBFULL

**Bench Length**

DESCRIPTION	CODE
30" Long	30
48" Long	48
72" Long	72
96" Long	96
120" Long	120

**Fully Upholstered Selection**

Please refer to Leland Textile Program which features textiles and leathers from the following partners:

- Camira
- Carnegie
- CF Stinson
- Green Hides
- Maharam
- Unika Vaev

The complete grade list can be found at [www.lelandfurniture.com/resources](http://www.lelandfurniture.com/resources) or you can specify COM/COL. All non pre-approved textiles need be tested for compatibility.

Due to upholstery requirements, the Ebb product line can only be upholstered railroaded. Please consider when specifying textiles with a pattern. Untested COM or COL textiles will not be accepted.

**Leg Finish**

Ebb fully upholstered linking benches have black powder coat skirts.

DESCRIPTION	CODE
Sterling	ST
Warm Grey	WG
Cool Grey	CG
Black	B
White	W
Matte Gold Rush	MGR
Matte Mercury	MMR
Matte Mineral	MMN
Matte Burnish	MBN
Matte Foundry	MFN
Black Textured	BT
Grey Textured	GT
White Textured	WT
Chrome	C

**Auxiliary Options**

Auxiliary Options must be specified at the time of the order.

**SKIRT:**

DESCRIPTION	CODE
Ebb Fully Upholstered Bench Skirt	SK

**FLOOR MOUNT:**

DESCRIPTION	CODE
Ebb Fully Upholstered Bench Floor Mount	FM
*Floor Mount requires Skirt.	

**Glides**

Ebb glides are nylon

**Product Specification**

Ebb layout is required at the quotation stage and order stage to ensure accurate product specifications. Contact Leland Customer Experience for CAD drawings.

## Specifications required to create the product code

- Model
- Bench Length
- Upholstery Selection
- Leg Finish
- Skirt (when applicable)
- Floor Mount (when applicable)



### MODEL

Ebb Fully Upholstered Bench  
Two Closed Ends (EBFUCC)

### BENCH LENGTH

72" (72)

### UPHOLSTERY SELECTION

Enter upholstery grade,  
COM or COL (COM)

### LEG FINISH

Specify Standard Powder Coat

### SKIRT

When Applicable, enter skirt code

### FLOOR MOUNT

When Applicable, enter Ebb floor  
mount code. Floor Mount requires Skirt.



# EBB FULLY UPHOLSTERED BENCH TWO CLOSED ENDS

Design: Mark Gabbartas

# EB5

Ebb Fully Upholstered Bench Two Closed Ends Skirt must be specified at the time of ordering. Skirt cannot be added later in the field.



## Ebb Fully Upholstered Bench

### Two Closed Ends

	MODEL	LIST PRICE/GRADE	COM/COL	A	B	C	D	E	F	G	H	I	J	K	L
30" long	EBFUCC-30		\$2107	2293	2423	2558	2697	2838	2986	3137	3293	3453	3619	3790	3965

W 17.5 L 18.5

COM Yardage: 1.75 yards  
For COL requirements please contact Leland Customer Care.



## Ebb Fully Upholstered Bench

### Two Closed Ends

	MODEL	LIST PRICE/GRADE	COM/COL	A	B	C	D	E	F	G	H	I	J	K	L
48" long	EBFUCC-48		\$2776	3036	3215	3401	3591	3787	3989	4197	4412	4633	4860	5095	5336

W 17.5 L 18.5

COM Yardage: 2.75 yards  
For COL requirements please contact Leland Customer Care.

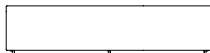

## Ebb Fully Upholstered Bench

### Two Closed Ends

	MODEL	LIST PRICE/GRADE	COM/COL	A	B	C	D	E	F	G	H	I	J	K	L
72" long	EBFUCC-72		\$3445	3769	3992	4223	4460	4703	4955	5214	5481	5756	6039	6330	6630

W 17.5 L 18.5

COM Yardage: 4.25 yards  
For COL requirements please contact Leland Customer Care.



## Ebb Fully Upholstered Bench

### Two Closed Ends

	MODEL	LIST PRICE/GRADE	COM/COL	A	B	C	D	E	F	G	H	I	J	K	L
96" long	EBFUCC-96		\$4113	4524	4804	5092	5389	5695	6010	6335	6669	7013	7368	7733	8110

W 17.5 L 18.5

COM Yardage: 5.5 yards  
For COL requirements please contact Leland Customer Care.



## Ebb Fully Upholstered Bench

### Two Closed Ends

	MODEL	LIST PRICE/GRADE	COM/COL	A	B	C	D	E	F	G	H	I	J	K	L
120" long	EBFUCC-120		\$4782	5276	5610	5955	6309	6674	7050	7437	7835	8246	8670	9106	9554

W 17.5 L 18.5

COM Yardage: 7 yards  
For COL requirements please contact Leland Customer Care.

To specify:

Please refer to pages 3-4 for complete specifying information. Specify all products by their product code.

Pricing Effective: February 2022

# EBB FULLY UPHOLSTERED BENCH ONE LINKING END

Design: Mark Gabbartas

# EB6



## Ebb Fully Upholstered Bench One Linking End

	MODEL	LIST PRICE/GRADE	COM/COL	A	B	C	D	E	F	G	H	I	J	K	L
30" long	EBFUCL-30		\$2145	2331	2463	2598	2738	2882	3031	3183	3341	3502	3670	3842	4019

W 17.5 L 18.5

COM Yardage: 1.75 yards  
For COL requirements please contact Leland Customer Care.  
Unit comes with skirt.



## Ebb Fully Upholstered Bench One Linking End

	MODEL	LIST PRICE/GRADE	COM/COL	A	B	C	D	E	F	G	H	I	J	K	L
48" long	EBFUCL-48		\$2814	3075	3256	3442	3634	3831	4034	4244	4460	4682	4912	5147	5390

W 17.5 L 18.5

COM Yardage: 2.75 yards  
For COL requirements please contact Leland Customer Care.  
Unit comes with skirt.



## Ebb Fully Upholstered Bench One Linking End

	MODEL	LIST PRICE/GRADE	COM/COL	A	B	C	D	E	F	G	H	I	J	K	L
72" long	EBFUCL-72		\$3481	3807	4031	4263	4501	4746	4998	5259	5526	5803	6087	6380	6683

W 17.5 L 18.5

COM Yardage: 4.25 yards  
For COL requirements please contact Leland Customer Care.  
Unit comes with skirt.



## Ebb Fully Upholstered Bench One Linking End

	MODEL	LIST PRICE/GRADE	COM/COL	A	B	C	D	E	F	G	H	I	J	K	L
96" long	EBFUCL-96		\$4149	4561	4842	5131	5430	5737	6054	6379	6715	7060	7417	7783	8161

W 17.5 L 18.5

COM Yardage: 5.5 yards  
For COL requirements please contact Leland Customer Care.  
Unit comes with skirt.

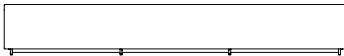

## Ebb Fully Upholstered Bench One Linking End

	MODEL	LIST PRICE/GRADE	COM/COL	A	B	C	D	E	F	G	H	I	J	K	L
120" long	EBFUCL-120		\$4818	5312	5645	5988	6341	6704	7079	7464	7862	8271	8693	9126	9573

W 17.5 L 18.5

COM Yardage: 7 yards  
For COL requirements please contact Leland Customer Care.  
Unit comes with skirt.

To specify:

Please refer to pages 3-4 for complete specifying information. Specify all products by their product code.

Pricing Effective: February 2022

EBB FULLY UPHOLSTERED BENCH TWO LINKING ENDS  
 Design: Mark Gabbartas

EB7



**Ebb Fully Upholstered Bench  
 Two Linking Ends**

	MODEL	LIST PRICE/GRADE	COM/COL	A	B	C	D	E	F	G	H	I	J	K	L
30" long	EBFULL-30		\$2180	2368	2500	2637	2778	2923	3072	3227	3385	3548	3717	3890	4069

W 17.5 L 18.5

COM Yardage: 1.75 yards  
 For COL requirements please contact Leland Customer Care.  
 Unit comes with skirt.



**Ebb Fully Upholstered Bench  
 Two Linking Ends**

	MODEL	LIST PRICE/GRADE	COM/COL	A	B	C	D	E	F	G	H	I	J	K	L
48" long	EBFULL-48		\$2847	3110	3292	3479	3672	3871	4075	4286	4503	4727	4956	5194	5438

W 17.5 L 18.5

COM Yardage: 2.75 yards  
 For COL requirements please contact Leland Customer Care.  
 Unit comes with skirt.



**Ebb Fully Upholstered Bench  
 Two Linking Ends**

	MODEL	LIST PRICE/GRADE	COM/COL	A	B	C	D	E	F	G	H	I	J	K	L
72" long	EBFULL-72		\$3520	3845	4071	4303	4543	4790	5044	5305	5574	5852	6138	6433	6736

W 17.5 L 18.5

COM Yardage: 4.25 yards  
 For COL requirements please contact Leland Customer Care.  
 Unit comes with skirt.



**Ebb Fully Upholstered Bench  
 Two Linking Ends**

	MODEL	LIST PRICE/GRADE	COM/COL	A	B	C	D	E	F	G	H	I	J	K	L
96" long	EBFULL-96		\$4186	4599	4881	5172	5471	5779	6096	6424	6762	7108	7466	7834	8213

W 17.5 L 18.5

COM Yardage: 5.5 yards  
 For COL requirements please contact Leland Customer Care.  
 Unit comes with skirt.

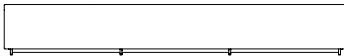

**Ebb Fully Upholstered Bench  
 Two Linking Ends**

	MODEL	LIST PRICE/GRADE	COM/COL	A	B	C	D	E	F	G	H	I	J	K	L
120" long	EBFULL-120		\$4855	5351	5688	6034	6390	6758	7136	7526	7928	8341	8767	9206	9659

W 17.5 L 18.5

COM Yardage: 7 yards  
 For COL requirements please contact Leland Customer Care.  
 Unit comes with skirt.

To specify:  
 Please refer to pages 3-4 for complete specifying information.  
 Specify all products by their product code.

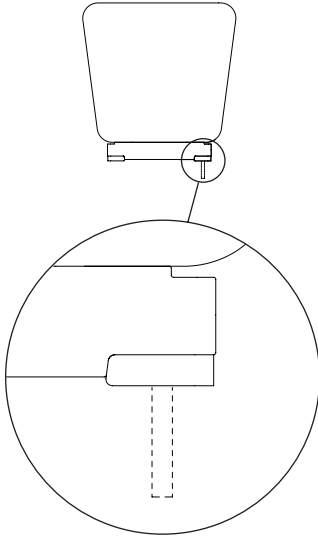

**Ebb Fully Upholstered Bench  
Floor Mount**

MODEL

LIST PRICE

FM

\$234

Due to the variety of floor surfaces on which Ebb products may be installed, floor mount fasteners are not supplied by Leland International. The Ebb product floor mount option consists of feet with floor mount brackets designed to use .5" thread diameter fasteners. Responsibility of fastener choice is the customers.

Floor Mount requires a skirt and both must be specified at the time of ordering. The Floor Mount cannot be added later in the field.



**Ebb Fully Upholstered Bench  
Two Closed Ends Skirt**

MODEL

LIST PRICE

Black Powdercoat Finish

SK

\$146

Ebb Fully Upholstered Bench Two Closed Ends Skirt must be specified at the time of ordering. Skirt cannot be added later in the field. Linking Ebb Benches come standard with skirts..

To specify:

Please refer to pages 3-4 for complete specifying information.

Specify all products by their product code.



**Hub Model**

DESCRIPTION	CODE
Ebb Hub, upholstered, one linking end	EBH1L
Ebb Hub, upholstered, two linking ends, 240 degrees	EBH2L
Ebb Hub, upholstered, two linking ends, 180 degrees	EBH3L
Ebb Hub, upholstered, three linking ends	EBH4L

**Upholstery Selection**

Please refer to Leland Textile Program which features textiles and leathers from the following partners:

- Camira
- Carnegie
- CF Stinson
- Green Hides
- Maharam
- Unika Vaev

The complete grade list can be found at [www.lelandfurniture.com/resources](http://www.lelandfurniture.com/resources) or you can specify COM/COL. All non pre-approved textiles need to be tested for compatibility.

Due to upholstery requirements, the Ebb product line can only be upholstered railroaded. Please consider when specifying textiles with a pattern. Untested COM or COL textiles will not be accepted.

**Powder Coat Frame Finishes**

Ebb Fully Upholstered Hubs have black powder coat skirts.

DESCRIPTION	CODE
Sterling	ST
Warm Grey	WG
Cool Grey	CG
Black	B
White	W
Matte Gold Rush	MGR
Matte Mercury	MMR
Matte Mineral	MMN
Matte Burnish	MBN
Matte Foundry	MFN
Black Textured	BT
Grey Textured	GT
White Textured	WT
Chrome	C

**Auxiliary Options**

Auxiliary Options must be specified at the time of the order.

DESCRIPTION	CODE
Ebb Fully Upholstered Hub Floor Mount	FM

**Glides**

Ebb glides are nylon.

**Product Specification**

Ebb layout is required at the quotation stage and order stage to ensure accurate product specifications. Contact Leland Customer Care for CAD drawings.

## Specifications required to create the product code

- Model
- Model
- Upholstery Selection
- Leg Finish
- Floor Mount (when applicable)



### MODEL

Ebb Fully Upholstered Hub -  
One Linking End (EBH1L)

### UPHOLSTERY SELECTION

Enter upholstery grade,  
COM or COL. Grade J (J)

### LEG FINISH

Specify Standard Powder Coat

### FLOOR MOUNT

When Applicable, enter Ebb  
floor mount code



**EBB FULLY UPHOLSTERED HUB**  
Design: Mark Gabbartas

# EB11

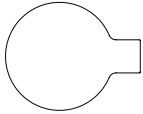

**Ebb Fully Upholstered Hub**

MODEL	LIST PRICE/GRADE	COM/COL	A	B	C	D	E	F	G	H	I	J	K	L
One linking end	EBH1L	\$6718	7444	7928	8428	8942	9473	10020	10581	11161	11757	12372	13005	13657

DIA 60 EXT 15

COM Yardage: 5.25 yards  
For COL requirements please contact Leland Customer Care.  
Unit comes with skirt.

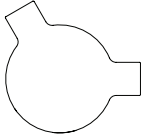

**Ebb Fully Upholstered Hub**

MODEL	LIST PRICE/ GRADE	COM/COL	A	B	C	D	E	F	G	H	I	J	K	L
Two linking ends, 240 degrees	EBH2L	\$7075	7902	8445	9005	9582	10176	10788	11419	12068	12736	13425	14135	14866

DIA 60 EXT 15

COM Yardage: 5.75 yards  
For COL requirements please contact Leland Customer Care.  
Unit comes with skirt.

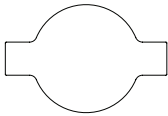

**Ebb Fully Upholstered Hub**

MODEL	LIST PRICE/ GRADE	COM/COL	A	B	C	D	E	F	G	H	I	J	K	L
Two linking ends, 180 degrees	EBH3L	\$7075	7902	8445	9005	9582	10176	10788	11419	12068	12736	13425	14135	14866

DIA 60 EXT 15

COM Yardage: 7 yards  
For COL requirements please contact Leland Customer Care.  
Unit comes with skirt.

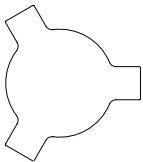

**Ebb Fully Upholstered Hub**

MODEL	LIST PRICE/ GRADE	COM/COL	A	B	C	D	E	F	G	H	I	J	K	L
Three linking ends	EBH4L	\$7433	8354	8954	9572	10209	10864	11539	12235	12950	13687	14448	15230	16036

DIA 60 EXT 15

COM Yardage: 8 yards  
For COL requirements please contact Leland Customer Care.  
Unit comes with skirt.

**To specify:**  
Please refer to pages 9-10 for complete specifying information.  
Specify all products by their product code.

EBB FULLY UPHOLSTERED HUB AUXILIARY OPTIONS

Design: Mark Gabbartas

# EB12

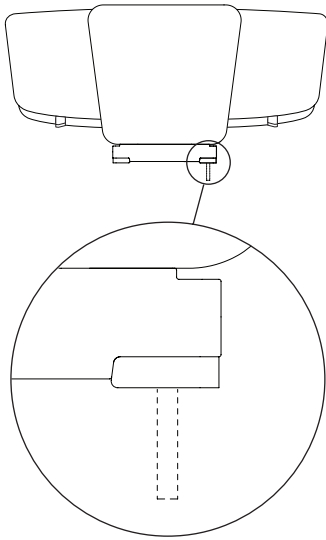

**Ebb Fully Upholstered Hub  
Floor Mount**

MODEL

LIST PRICE

FM

\$234

Due to the variety of floor surfaces on which Ebb products may be installed, floor mount fasteners are not supplied by Leland International. The Ebb product floor mount option consists of feet with floor mount brackets designed to use .5" thread diameter fasteners. Responsibility of fastener choice is the customers.

Floor Mount must be specified at the time of ordering.

The Floor Mount cannot be added later in the field.

To specify:

Please refer to pages 9-10 for complete specifying information.

Specify all products by their product code.

Pricing Effective: February 2022

## Pod Model

DESCRIPTION	CODE
Ebb Fully Upholstered Pod	EBH5

## Upholstery Selection

Please refer to Leland Textile Program which features textiles and leathers from the following partners:

- Camira
- Green Hides
- Carnegie
- Maharam
- CF Stinson
- Unika Vaev

The complete grade list can be found at [www.lelandfurniture.com/resources](http://www.lelandfurniture.com/resources) or you can specify COM/COL.

Due to upholstery requirements, the Ebb product line can only be upholstered railroaded. Please consider when specifying textiles with a pattern. Untested COM or COL textiles will not be accepted.

## Leg Finish

DESCRIPTION	CODE
Sterling	ST
Warm Grey	WG
Cool Grey	CG
Black	B
White	W
Matte Gold Rush	MGR
Matte Mercury	MMR
Matte Mineral	MMN
Matte Burnish	MBN
Matte Foundry	MFN
Black Textured	BT
Grey Textured	GT
White Textured	WT
Chrome	C

## Auxiliary Options

Auxiliary Options must be specified at the time of the order.

### SKIRT:

DESCRIPTION	CODE
Ebb Fully Upholstered Pod Skirt	SK

### FLOOR MAT:

DESCRIPTION	CODE
Ebb Fully Upholstered Pod Floor Mount	FM
Floor Mount requires Skirt.	

## Glides

Ebb glides are nylon.

## Product Specification

Ebb layout is required at the quotation stage and order stage to ensure accurate product specifications. Contact Leland Customer Experience for CAD drawings.

## Specifications required to create the product code

- Model
- Upholstery Selection
- Leg Finish
- Skirt (when applicable)
- Floor Mount (when applicable)



### MODEL

Ebb Fully Upholstered Pod (EBH5)

### UPHOLSTERY SELECTION

Enter upholstery grade, COM or COL. Grade J (J)

### LEG FINISH

Specify Standard Powder Coat

### SKIRT

Skirt (SK)

### FLOOR MOUNT

When applicable, enter Ebb floor mount code. Floor Mount requires Skirt.



EBB FULLY UPHOLSTERED POD  
Design: Mark Gabbartas

# EB15

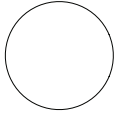

<b>Ebb Fully Upholstered Pod</b>	<b>MODEL</b>	<b>LIST PRICE/GRADE</b>	<b>COM/COL</b>	<b>A</b>	<b>B</b>	<b>C</b>	<b>D</b>	<b>E</b>	<b>F</b>	<b>G</b>	<b>H</b>	<b>I</b>	<b>J</b>	<b>K</b>	<b>L</b>
No linking end	EBH5		\$6213	6924	7395	7879	8379	8893	9423	9969	10531	11111	11706	12321	12953

DIA 54 SH 18.5

COM Yardage: 6 yards  
For COL requirements please contact Leland Customer Care.

To specify:  
Please refer to pages 13-14 for complete specifying information.  
Specify all products by their product code.

Pricing Effective: February 2022

**EBB FULLY UPHOLSTERED POD AUXILIARY OPTIONS**

Design: Mark Gabbartas

# EB16

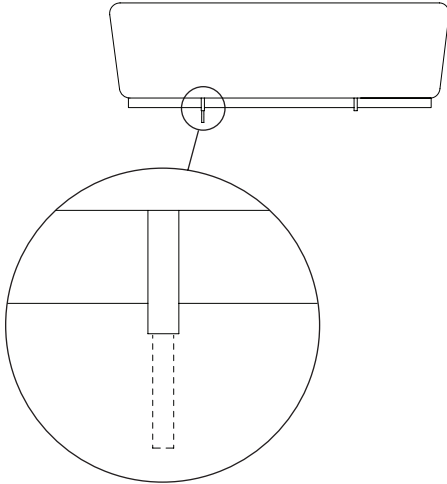

**Ebb Fully Upholstered Pod  
Floor Mount**

	MODEL	LIST PRICE
	FM	\$234

Due to the variety of floor surfaces on which Ebb products may be installed, floor mount fasteners are not supplied by Leland International. The Ebb product floor mount option consists of feet with floor mount brackets designed to use .5" thread diameter fasteners. Responsibility of fastener choice is the customers.

Floor Mount requires a skirt and both must be specified at the time of ordering. The Floor Mount cannot be added later in the field.



**Ebb Fully Upholstered Pod  
Skirt**

	MODEL	LIST PRICE
Black Powdercoat Finish	SK	\$146

Ebb Fully Upholstered Bench Two Closed Ends Skirt must be specified at the time of ordering. Skirt cannot be added later in the field.

**To specify:**  
Please refer to pages 13-14 for complete specifying information. Specify all products by their product code.

**Pricing Effective: February 2022**



---

**5695 Eagle Drive, SE  
Grand Rapids,  
Michigan 49512  
616-975-9260  
lelandfurniture.com**

---

**5695 Eagle Drive, SE**  
**Grand Rapids,**  
**Michigan 49512**  
**616-975-9260**  
**[lelandfurniture.com](http://lelandfurniture.com)**













# Fast Table

## February 2022 Price List



# Fast Table

Table of Contents	FT2
Visual Reference	FT3
Table Top Specification Information	FT4
Table Top Specification Example	FT5
Table Tops	FT6
Table Base Specification Information	FT7
Table Base Specification Example	FT8
Table Bases	FT9
Modesty Panel Specification Information	FT10
Modesty Panel Specification Example	FT11
Modesty Panel	FT12
Transport Trolley Specification Information	FT13
Transport Trolley Specification Example	FT14
Transport Trolley	FT15

TABLE MODEL	TABLE TOP SIZES			BASE	PAGE
Size A	Round	Sqaure	Rectangle	Powdercoat	Top: Page 6 Base: Page 9
	 48 DIA 54 DIA	 42 x 42	 24 x 48 30 x 48		
Size B	Round	Sqaure	Rectangle	Powdercoat	Top: Page 6 Base: Page 9
	 60 DIA	 48 x 48	 24 x 60 30 x 60		
Size C	Round	Sqaure	Rectangle	Powdercoat	Top: Page 6 Base: Page 9
	 72 DIA	 54 x 54	 24 x 72 30 x 72		

To specify:  
Please refer to pages 3-4 for complete specifying information.  
Specify all products by their product code.

Due to the design intent of Fast, table tops and table bases are sold separately. This page is for specifying the table top only.

**Table Top Model**

ROUND	FITS BASE	CODE
48 DIA	A	F48A
54 DIA	A	F54A
60 DIA	B	F60B
72 DIA	C	F72C
<b>SQUARE</b>		
42x42	A	F4242A
48x48	B	F4848B
54x54	C	F5454C
<b>RECTANGLE</b>		
24x48	A	F2448A
30x48	A	F3048A
24x60	B	F2460B
30x60	B	F3060B
24x72	C	F2472C
30x72	C	F3072C

**Top Surface**

**LAMINATE TOPS:**

DESCRIPTION	CODE
Identify manufacturer, laminate code, & color	L

Please refer to the Leland Terms and Conditions Guide for a listing of standard laminates. For table pricing in laminates not listed, please contact Leland's Customer Experience Department for a quotation.

**Edge Type**

**V7 VINYL EDGE:**

.75" 3mm PVC



**Edge Color**

**V7 VINYL EDGE COLORS:**

DESCRIPTION	CODE
Black	B
Grey	G
Pewter	PW
Saddle	SL
Stone	SN
Truffle	TF
White	W

**Attachment Color**

DESCRIPTION	CODE
Black	B

**Auxiliary Options**

DESCRIPTION	CODE
Ganging Device (two per set)	GD

**Product Weights**

BASES	LBS
FBA	15
FBB	20
FBC	25

ROUND	FITS BASE	LBS
48 DIA	A	50
54 DIA	A	60
60 DIA	B	65
72 DIA	C	75

SQUARE	FITS BASE	LBS
42x42	A	50
48x48	B	60
54x54	C	70

RECTANGLE	FITS BASE	LBS
24x48	A	30
30x48	A	40
24x60	B	35
30x60	B	45
24x72	C	45
30x72	C	55

**Specifications required to create the product code**

- Model
- Top Surface
- Edge Color
- Attachment Color
- Auxiliary Options (when applicable)



**MODEL**

Fast 30 x 60 Rectangle Table Top (F3060B)

**TOP SURFACE**

Laminate (L)

**EDGE COLOR**

Grey (G)

**ATTACHMENT COLOR**

Black (B)

**AUXILIARY OPTIONS**



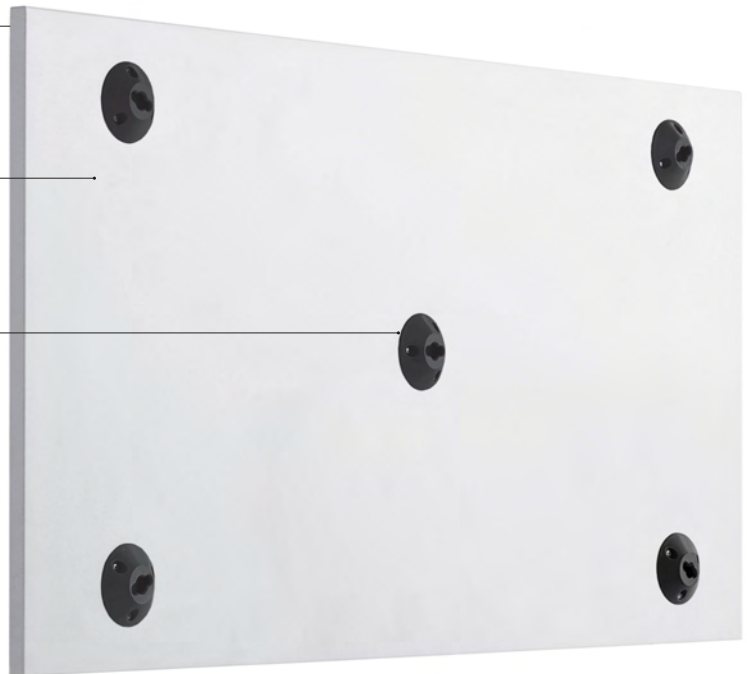





When applicable



# FAST TABLE TOPS

Design: Carlos Tíscar, licensed by Sellex

# FT6

Fast Table Top	MODEL	FRAME FINISH	LIST PRICE
Laminate Top			
Top sizes for base A	F48A	48 DIA	\$1232
  	F54A	54 DIA	\$1255
Round	F60B	60 DIA	\$1281
48 DIA	F72C	72 DIA	\$3412
54 DIA	F4242A	42x42	\$946
	F4848B	48x48	\$974
Top sizes for base B	F5454C	54x54	\$1400
  	F2448A	24x48	\$526
Round	F3048A	30x48	\$621
60 DIA	F2460B	24x60	\$647
	F3060B	30x60	\$749
	F2472C	24x72	\$732
Top sizes for base C	F3072C	30x72	\$875
  			
Square			
72 DIA			

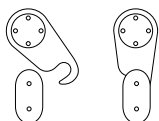

Ganging Device	MODEL	LIST PRICE
two per set	GD	\$173

To specify:  
 Please refer to pages 3-4 for  
 complete specifying information.  
 Specify all products by their  
 product code.

Pricing Effective: February 2022



Due to the design intent of Fast, table tops and table bases are sold separately. This page is for specifying the table bases only.

### Table Base Model

---

DESCRIPTION	CODE
Base A (fits 48 Dia, 54 Dia, 42x42, 24x48 and 30x48)	FBA
Base B (fits 60 Dia, 48x48, 24x60 and 30x60)	FBB
Base C (fits 72 Dia, 54x54, 24x72 and 30x72)	FBC

### Base Finish

---

DESCRIPTION	CODE
Sterling	ST
Warm Grey	WG
Cool Grey	CG
Black	B
White	W
Matte Gold Rush	MGR
Matte Mercury	MMR
Matte Mineral	MMN
Matte Burnish	MBN
Matte Foundry	MFN
Matte New Penny	MNP

### Glide and Attachment Color

---

DESCRIPTION	CODE
Black	B

### Freight Note

---

Due to the size and nature of Fast Tables, the Freight Program does not apply to this product. Please contact Customer Experience for a quote.

**Specifications required to create the product code**

- Model
- Base Finish
- Glide and Attachment Color

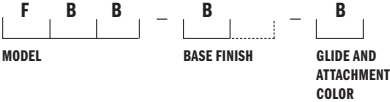

**MODEL**

Fast Size B Table Base (FBB)

**BASE FINISH**

Black (B)

**GLIDE AND ATTACHMENT COLOR**

Black (B)



# FAST TABLE BASES

Design: Carlos Tíscar, licensed by Sellex

# FT9



Base Size A	MODEL	LIST PRICE
W 46.7 H 27.4	FBA	\$1183

Fits Top Sizes:



Round  
48 DIA  
54 DIA



Square  
42 x 42



Rectangle  
24 x 48  
30 x 48

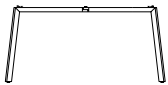

Base Size B	MODEL	LIST PRICE
W 57.8 H 27.4	FBB	\$1206

Fits Top Sizes:



Round  
60 DIA



Square  
48 x 48



Rectangle  
24 x 60  
30 x 60

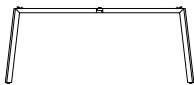

Base Size C	MODEL	LIST PRICE
W 68 H 27.4	FBC	\$1232

Fits Top Sizes:



Round  
72 DIA



Square  
54 x 54



Rectangle  
24 x 72  
30 x 72

**To specify:**

**Please refer to table bases on pages 4-5 and table tops on pages 7-8 for complete specifying information.**

**Specify all products by their product code.**

**Model**

---

DESCRIPTION	FITS BASE	CODE
Modesty panel for 24x48 table	A	FM2448
Modesty panel for 30x48 table	A	FM3048
Modesty panel for 24x60 table	B	FM2460
Modesty panel for 30x60 table	B	FM3060
Modesty panel for 24x72 table	C	FM2472
Modesty panel for 30x72 table	C	FM3072

**Modesty Panel Cover**

---

DESCRIPTION	CODE
Grey	G

**Optional Modesty Panel Cover (Orders of 20+ Units)**

---

DESCRIPTION	CODE
Black	B
White	W

**Specifications required to create the product code**

- Model
- Modesty Panel Color

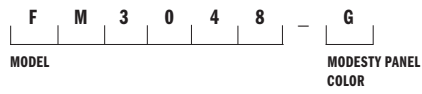

**MODEL**

Fast Modesty Panel for 30 x 48  
Table (FM3048)

**MODESTY PANEL COVER**

Grey (G)



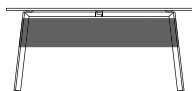

Modesty Panel	MODEL	SIZE	LIST PRICE
		Base A	
	FM2448	24x48	\$259
	FM3048	30x48	\$259
		Base B	
	FM2460	24x60	\$272
	FM3060	30x60	\$272
		Base C	
	FM2472	24x72	\$287
	FM3072	30x72	\$287

**To specify:**

Please refer to table bases on pages 4-5, table tops on pages 7-8 and modesty panels on pages 10-11 for complete specifying information. Specify all products by their product code.

**Model**

---

DESCRIPTION	CODE
Fast Transport Trolley	FTT

**Specifications required to create the product code**

Model



**MODEL**

Fast Transport Trolley (FTT)





**FAST TRANSPORT TROLLEY**  
 Design: Carlos Tíscar, licensed by Sellex

# FT15

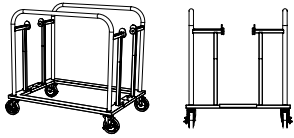

Fast Transport Trolley	MODEL	LIST PRICE
Black powder coat finish	FTT	\$2143
W 38.75 D 29.5 H 37.5		

The Fast Transport Trolley can hold up to 6 table bases and 6 table tops.

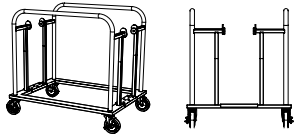

Fast Transport Trolley	MODEL	LIST PRICE
Black powder coat finish	FTT-72	\$2357
W 38.75 D 29.5 H 37.5		

The Fast Transport Trolley can hold up to (6) C table bases and (4) 72 DIA table tops.

**To specify:**  
 Please refer to page 13-14 for complete  
 specifying information. Specify all products by  
 their product code.

---

**5695 Eagle Drive, SE**  
**Grand Rapids,**  
**Michigan 49512**  
**616-975-9260**  
**[lelandfurniture.com](http://lelandfurniture.com)**

# Fixed Table

## February 2022 Price List



# Fixed Table

Table of Contents	FXT2
Visual Reference	FXT3
Specification Information	FXT4
Specification Example	FXT5
Power Planning	FXT6
Round Table	FXT7
Square Table	FXT8
Rectangular Table	FXT9
Counter Height Rectangular Tables	FXT11
Rectangular Bar Height Table	FXT13
Auxiliary Options	FXT15

TABLE MODEL	TABLE TOP SIZES	OPTIONAL POWER	PAGE
Round table	Round  42 DIA 48 DIA 54 DIA 60 DIA	1 Simplex Dual USB	6

TABLE MODEL	TABLE TOP SIZES	OPTIONAL POWER	PAGE
Square table	Square  42 x 42 48 x 48 54 x 54 60 x 60	1 Simplex Dual USB	7

TABLE MODEL	TABLE TOP SIZES	OPTIONAL POWER	PAGE
Rectangular table	Rectangle  30 x 60    36 x 72    42 x 84 30 x 72    36 x 84    42 x 96 30 x 84    36 x 96    42 x 120 36 x 120	2 Simplex units, 1 Dual USB 1 Simplex Dual USB	8

TABLE MODEL	TABLE TOP SIZES	OPTIONAL POWER	PAGE
Rectangular table Counter height	Rectangle  30 x 60    36 x 72    42 x 84 30 x 72    36 x 84    42 x 96 30 x 84    36 x 96    42 x 120 36 x 120	2 Simplex units, 1 Dual USB 1 Simplex Dual USB	9

TABLE MODEL	TABLE TOP SIZES	OPTIONAL POWER	PAGE
Rectangular table Bar height	Rectangle  30 x 60    36 x 72    42 x 84 30 x 72    36 x 84    42 x 96 30 x 84    36 x 96    42 x 120 36 x 120	2 Simplex units, 1 Dual USB 1 Simplex Dual USB	9

## Table Model

DESCRIPTION	CODE
Fixed Table	FXT

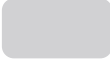
## Top Selection

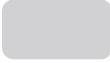
ROUND		SQUARE	
DESCRIPTION	CODE	DESCRIPTION	CODE
42D	42D-29	42x42	4242-29
48D	48D-29	48x48	4848-29
54D	54D-29	54x54	5454-29
60D	60D-29	60x60	6060-29

RECTANGULAR		COUNTER HEIGHT RECTANGULAR	
DESCRIPTION	CODE	DESCRIPTION	CODE
30x60	3060-29	30x60	3060-36
30x72	3072-29	30x72	3072-36
30x84	3084-29	30x84	3084-36
36x72	3672-29	36x72	3672-36
36x84	3684-29	36x84	3684-36
36x96	3696-29	36x96	3696-36
36x120	36120-29	36x120	36120-36
42x84	4284-29	42x84	4284-36
42x96	4296-29	42x96	4296-36
42x120	42120-29	42x120	42120-36

BAR HEIGHT RECTANGULAR	
DESCRIPTION	CODE
30x60	3060-42
30x72	3072-42
30x84	3084-42
36x72	3672-42
36x84	3684-42
36x96	3696-42
36x120	36120-42
42x84	4284-42
42x96	4296-42
42x120	42120-42

## Top and Edge Finish

### HPL (HIGH PRESSURE LAMINATE)

DESCRIPTION	CODE
Platinum Wilsonart® (D315-60)	LGP
Black Pionite® (SE101)	LBK
White Wilsonart® (D354-60)	LWH

Edge finish options: Matching ABS (V5), natural (11) plywood (W2)  
 Please refer to the Leland Terms and Conditions Guide for a listing of standard laminates.  
 For table pricing in laminates not listed, please contact Leland's Customer Experience Department for a quotation.

### FORBO

DESCRIPTION	CODE
Pearl	4157
Mauve	4172
Pebble	4175
Smokey Blue	4179
Olive	4184

Edge finish options: natural (11) plywood (W2)

**Pricing Effective: February 2022**

## Top and Edge Finish (cont.)

### CORIAN



DESCRIPTION	CODE
Silverite	CG
Nocturne	CB
Cameo White	CW
Domino Terrazzo	CDT
Basalt Terrazzo	CBT
Pebble Terrazzo	CPT

Edge finish options: S1 Edge (CG, CB, & CW) and S2 Edge (CDT, CBT, & CPT)

## Leg Finish

DESCRIPTION	CODE
White Textured Powder coat	WT
Black Textured Powder coat	BT
Grey Textured Powder coat	GT

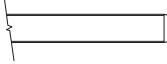
## Edge Type

DESCRIPTION	CODE	DESCRIPTION	CODE
3/4" flat PVC	V5	1" flat plywood	W2
	1" square (Solid Color Corian Tops)	S1	1" bullnose (Terrazzo Corian Tops)
			

## Glide Type

DESCRIPTION
Standard (Black nylon adjustable leveling)

## Power Options

DESCRIPTION	CODE
Single Simplex Unit (centered)	PWR
Dual USB Unit (centered)	USB
Power Kit	KIT
*(2) Single Simplex & (1) Dual USB (only available on rectangular tables)	

## Auxiliary Options

DESCRIPTION	CODE
Storage Caddy	SC
*only available on rectangular tables	

**Specifications required to create the product code**

- Model
- Top Selection
- Top Finish
- Leg Finish
- Edge Type
- Power (if applicable)
- Auxiliary Option (if applicable)
- Glide Type



**MODEL**

Fixed Table (FXT)

**TOP SELECTION**

Counter Height Rectangular  
(3060-36)

**TOP FINISH**

Black Laminate (LBK)

**LEG FINISH**

Black Textured Powder coat (BT)

**EDGE TYPE**

1" flat plywood (W2)

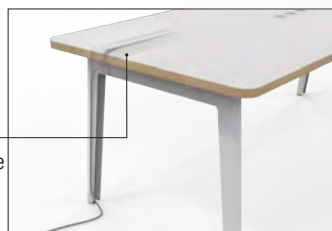

**POWER**

When applicable enter power option (see page FXT6 for options)

**AUXILIARY OPTION**

Storage Caddy (SC)

**GLIDE**

Standard (S)



## Options

- Single Simplex Unit (centered, includes 120" plug-in infeed) (PWR)
- Dual USB Unit (centered) (USB)
- Power Kit (KIT)
- \*(2) Single Simplex & (1) Dual USB (only available on rectangular tables, centered)



Single Simplex Unit



Dual USB



Wire Management

## Power Kit (-KIT)

- \*(2) Single Simplex & (1) Dual USB (only available on rectangular tables, centered)





**FIXED TABLE ROUND**  
 Design: 2B Studio, Justin Burton

# FXT7



**Fixed Table Round**

	MODEL	TOP SIZE/CODE	LIST PRICE/EDGE CODES:	V5	W2
Powder coat base	FXT-	Laminate Top			
H 29		42D		\$2023	2327
		48D		\$2076	2450
		54D		\$2130	2556
Round		60D		\$2191	2673
42 DIA					
48 DIA		Forbo Top			W2
54 DIA		42D			\$2429
60 DIA		48D			\$2493
		54D			\$2557
		60D			\$2635
		Corian Top	S1		
		42D	\$5044		
		48D	\$5224		
		54D	\$5394		
		60D	\$5551		
		Terrazzo Corian Top	S2		
		42D	\$6962		
		48D	\$8090		
		54D	\$8822		
		60D	\$9547		

To specify:  
 Please refer to pages 3-4 for complete specifying information.  
 Specify all products by their product code.

**Pricing Effective: February 2022**

**FIXED TABLE SQUARE**  
 Design: 2B Studio, Justin Burton

**FXT8**

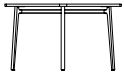

<b>Fixed Table Square</b>	<b>MODEL</b>	<b>TOP SIZE/CODE</b>	<b>LIST PRICE/EDGE CODES:</b>	<b>V5</b>	<b>W2</b>
Powder coat base	FXT-	Laminate Top			
H 29		42x42		\$2023	2327
		48x48		\$2076	2450
		54x54		\$2130	2556
	Square	60x60		\$2191	2673
42x42					
48x48		Forbo Top			<b>W2</b>
54x54		42x42			\$2429
60x60		48x48			\$2493
		54x54			\$2557
		60x60			\$2635
		Corian Top	<b>S1</b>		
		42x42	\$5044		
		48x48	\$2022		
		54x54	\$5394		
		60x60	\$5551		
		Terrazzo Corian Top	<b>S2</b>		
		42x42	\$6962		
		48x48	\$8090		
		54x54	\$8822		
		60x60	\$9547		

**To specify:**  
 Please refer to pages 3-4 for complete specifying information.  
 Specify all products by their product code.

**Pricing Effective: February 2022**

**FIXED TABLE RECTANGULAR**  
 Design: 2B Studio, Justin Burton

# FXT9



<b>Fixed Table Rectangular</b>	<b>MODEL</b>	<b>TOP SIZE/CODE</b>	<b>LIST PRICE/EDGE CODES:</b>	<b>V5</b>	<b>W2</b>
Powder coat base	FXT-	Laminate Top			
H 29		30x60		\$2130	2449
		30x72		\$2295	2640
		30x84		\$2450	2891
Rectangle		36x72		\$2626	3099
30x60		36x84		\$2877	3452
30x72		36x96		\$3047	3716
30x84		36x120		\$3467	4333
36x84		42x84		\$3169	3927
36x96		42x96		\$3292	4082
36x120		42x120		\$3538	4392
42x84					
42x96		Forbo Top			<b>W2</b>
42x120		30x60			\$2619
		30x72			\$2824
		30x84			\$3016
		36x72			\$3230
		36x84			\$3512
		36x96			\$3717
		36x120			\$4204
		42x84			\$3877
		42x96			\$4032
		42x120			\$4342

**To specify:**  
 Please refer to pages 3-4 for complete specifying information.  
 Specify all products by their product code.

**Pricing Effective: February 2022**

**FIXED TABLE RECTANGULAR cont.**  
 Design: 2B Studio, Justin Burton

**FXT10**



**Fixed Table Rectangular**

	MODEL	TOP SIZE/CODE	LIST PRICE/EDGE CODES:
Powder coat base	FXT-	Corian Top	<b>S1</b>
H 29		30x60	\$5175
		30x72	\$5319
		30x84	\$5495
		36x72	\$5652
		36x84	\$5804
		36x96	\$5930
		36x120	\$6208
		42x84	\$6079
		42x96	\$6192
		42x120	\$6416
		Terrazzo Corian Top	<b>S2</b>
		30x60	\$6560
		30x72	\$7062
		30x84	\$7530
		36x72	\$8065
		36x84	\$8825
		36x96	\$9338
		36x120	\$10612
		42x84	\$9721
		42x96	\$10204
		42x120	\$11171

**To specify:**  
 Please refer to pages 3-4 for complete specifying information.  
 Specify all products by their product code.

**Pricing Effective: February 2022**

**FIXED TABLE COUNTER HEIGHT RECTANGULAR**  
 Design: 2B Studio, Justin Burton

**FXT11**

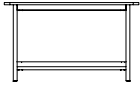

**Fixed Table Counter Height  
 Rectangular**

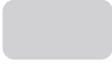
	MODEL	TOP SIZE/CODE	LIST PRICE/EDGE CODES:	V5	W2
Powder coat base	FXT-	Laminate Top			
H 36		30x60		\$3240	3726
		30x72		\$3363	3866
		30x84		\$3485	4112
	Rectangle	36x72		\$3592	4238
30x60		36x84		\$3699	4439
30x84		36x96		\$3795	4554
36x72		36x120		\$3998	4870
36x84		42x84		\$3934	4798
36x96		42x96		\$3987	4862
36x120		42x120		\$4094	4991
42x84					
42x96		Forbo Top			<b>W2</b>
42x120		30x60			\$3372
		30x72			\$3498
		30x84			\$3625
		36x72			\$3736
		36x84			\$3848
		36x96			\$3948
		36x120			\$4159
		42x84			\$4092
		42x96			\$4135
		42x120			\$4223

**To specify:**  
 Please refer to pages 3-4 for complete specifying information.  
 Specify all products by their product code.

**Pricing Effective: February 2022**

**FIXED TABLE COUNTER HEIGHT RECTANGULAR cont.**  
 Design: 2B Studio, Justin Burton

**FXT12**



**Fixed Table Counter Height  
 Rectangular**

	MODEL	TOP SIZE/CODE	LIST PRICE/EDGE CODES:
Powder coat base	FXT-	Corian Top	<b>S1</b>
H 36		30x60	\$5969
		30x72	\$6059
		30x84	\$6178
		36x72	\$6292
		36x84	\$6400
		36x96	\$6540
		36x120	\$6787
		42x84	\$6645
		42x96	\$6811
		42x120	\$7142
		Terrazzo Corian Top	<b>S2</b>
		30x60	\$8863
		30x72	\$9194
		30x84	\$9526
		36x72	\$9815
		36x84	\$10211
		36x96	\$10363
		36x120	\$10912
		42x84	\$10767
		42x96	\$10883
		42x120	\$11116

**To specify:**  
 Please refer to pages 3-4 for complete specifying information.  
 Specify all products by their product code.

**Pricing Effective: February 2022**

**FIXED TABLE BAR HEIGHT RECTANGULAR**  
 Design: 2B Studio, Justin Burton

**FXT13**

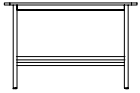

**Fixed Table Bar Height  
 Rectangular**

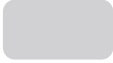
	MODEL	TOP SIZE/CODE	LIST PRICE/EDGE CODES:	V5	W2
Powder coat base	FXT-	Laminate Top			
H 42		30x60		\$3267	3757
		30x72		\$3389	3897
		30x84		\$3512	4144
Rectangle		36x72		\$3619	4269
30x60		36x84		\$3726	4471
30x72		36x96		\$3822	4586
36x72		36x120		\$4024	4903
36x84		42x84		\$3960	4832
36x96		42x96		\$4014	4897
36x120		42x120		\$4121	5027
42x84					
42x96		Forbo Top			<b>W2</b>
42x120		30x60			\$3399
		30x72			\$3525
		30x84			\$3652
		36x72			\$3763
		36x84			\$3875
		36x96			\$3964
		36x120			\$4164
		42x84			\$4118
		42x96			\$4162
		42x120			\$4250

**To specify:**  
 Please refer to pages 3-4 for complete specifying information.  
 Specify all products by their product code.

**Pricing Effective: February 2022**

**FIXED TABLE BAR HEIGHT RECTANGULAR cont.**  
 Design: 2B Studio, Justin Burton

**FXT14**

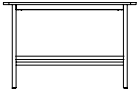

**Fixed Table Bar Height  
 Rectangular**

	MODEL	TOP SIZE/CODE	LIST PRICE/EDGE CODES:
Powder coat base	FXT-	Corian Top	<b>S1</b>
H 42		30x60	\$6053
		30x72	\$6154
		30x84	\$6195
		36x72	\$6311
		36x84	\$6422
		36x96	\$6542
		36x120	\$6772
		42x84	\$6670
		42x96	\$6832
		42x120	\$7157
		Terrazzo Corian Top	<b>S2</b>
		30x60	\$8828
		30x72	\$9160
		30x84	\$9491
		36x72	\$9780
		36x84	\$10069
		36x96	\$10329
		36x120	\$10878
		42x84	\$10704
		42x96	\$11011
		42x120	\$11626

To specify:  
 Please refer to pages 3-4 for  
 complete specifying information.  
 Specify all products by their  
 product code.

**Pricing Effective: February 2022**



<b>Single Simplex Unit</b>	<b>MODEL</b>	<b>LIST PRICE</b>
	PWR	\$127

<b>Dual USB Unit</b>	<b>MODEL</b>	<b>LIST PRICE</b>
	USB	\$227

<b>Power Kit</b>	<b>MODEL</b>	<b>LIST PRICE</b>
	KIT	\$1407

<b>Fixed Table Storage Caddy</b>	<b>MODEL</b>	<b>LIST PRICE</b>
	SC	\$413

To specify:  
Please refer to pages 3-4 for  
complete specifying information.  
Specify all products by their  
product code.

---

**5695 Eagle Drive, SE  
Grand Rapids,  
Michigan 49512  
616-975-9260  
lelandfurniture.com**

# Fly Table

## February 2022 Price List



# Fly Table

Table of Contents	FLY2
Specification Information	FLY3
Specification Example	FLY4
Textured Paint	FLY5
HPL	FLY5
Wood Veneer	FLY6

## Table Model

DESCRIPTION	CODE
Fly Table	FLY

## Top Collection

RECTANGLE		ROUND	
DESCRIPTION	CODE	DESCRIPTION	CODE
30x60	3060	30D	30D
36x72	3672	36D	36D
42x84	4284	42D	42D
		48D	48D

LEFT HAND 'L'		OVAL	
DESCRIPTION	CODE	DESCRIPTION	CODE
40x55	4055L	30x60	30600
46x63	4663L	36x72	36720
52x72	5272L	42x84	42840
		48x96	48960

RIGHT HAND 'L'	
DESCRIPTION	CODE
40x55	4055R
46x63	4663R
52x72	5272R

VISUAL REFERENCE:



Left and right hand designations are as seated.

## Top and Edge Finish

WOOD VENEER TEXTURED PAINT			
DESCRIPTION	CODE	DESCRIPTION	CODE
Rift Cut Oak	O	White	WT
Walnut	W	Black	BT
		Grey	GT

Edge finish options:

Natural	11	Edge finish painted to match
Oak stain match	O	
Walnut stain match	W	

HPL (HIGH PRESSURE LAMINATE)	
DESCRIPTION	CODE
Grey	Platinum Wilsonart® (D315-60)
Black	Black Pionite® (SE101)
White Designer	White Wilsonart® (D354-60)

Edge Finish Natural (11) Plywood only

## Leg Selection

DESCRIPTION	CODE
Powder coat Legs	P
Polished Aluminum Legs	PA

## Leg Finish (when applicable)

DESCRIPTION	CODE
White Textured Powder coat	WT
Black Textured Powder coat	BT
Grey Textured Powder coat	GT

\*Please Note: Leg finish specification is required ONLY for Powder coat (P) legs

## Edge Type

STANDARD EDGE:  
reverse back bevel

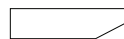

## Glide Type

DESCRIPTION	CODE
Black Rubber Glide	S

## Auxiliary Options

DESCRIPTION	CODE	DESCRIPTION	CODE
Power Flip Top Grommet	PT	Front Divider Screen	FD
Cable Duct	CD	Side Divider Screen	SD
Textile Cable Tray	CT	Courtesy Screen	CS
Ganging	G		

Auxiliary options are priced upon request. Please contact Customer Experience (800) 859-7510 for pricing.

## Specifications required to create the product code

---

- Table Model
- Top Selection
- Top Finish
- Leg Selection
- Leg Finish
- Glide Selection

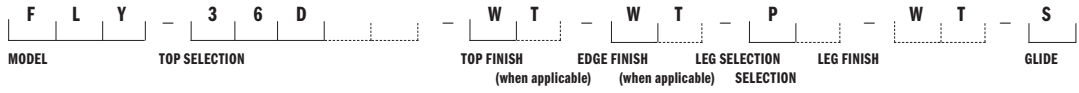

---

### MODEL

Fly Table (FLY)

### TOP SELECTION

36 Diameter Round (36D)

### TOP FINISH

White Textured Paint (WT)

### EDGE FINISH

White Textured Paint (WT)

### LEG SELECTION

Powder coat (P)

### LEG FINISH

White Textured Paint (WT)

### GLIDE SELECTION

Standard Glide (S)







# FLY TABLE





Design: Lievore Altherr Molina, licensed by Sellex

# FLY5

## Textured Paint Top

			TOP SHAPE	TOP SIZE	POWDERCOAT LEGS	POLISHED ALUMINUM LEGS	
H 29.5	Top Shape		Rectangle	30x60	\$1853	1972	
				36x72	\$2116	2233	
				42x84	\$2426	2544	
			L - Table	40x55	\$1988	2105	
				46x63	\$2218	2335	
				52x72	\$2498	2615	
			Round	30D	\$1555	1674	
				36D	\$1686	1803	
				42D	\$1840	1959	
				48D	\$2020	2137	
				Oval	30x60	\$1920	2038
					36x72	\$2209	2327
				48x96	\$2549	2668	

## HPL Top (High Pressure Laminate)

			TOP SHAPE	TOP SIZE	POWDERCOAT LEGS	POLISHED ALUMINUM LEGS
H 29.5	Top Shape		Rectangle	30x60	\$1918	2036
				36x72	\$2207	2325
				42x84	\$2547	2666
			L - Table	40x55	\$2065	2181
				46x63	\$2320	2436
				52x72	\$2626	2743
			Round	30D	\$1591	1708
				36D	\$1735	1852
				42D	\$1907	2023
				48D	\$2102	2219
			Oval	30x60	\$1992	2109
				36x72	\$2309	2426
				42x84	\$2685	2802
				48x96	\$2854	2972





**To specify:**  
 Please refer to pages 3-4 for complete specifying information.  
 Specify all products by their product code.

# FLY TABLE

Design: Lievore Altherr Molina, licensed by Sellex

# FLY6

## Wood Veneer Top

		TOP SHAPE	TOP SIZE	POWDERCOAT LEGS	POLISHED ALUMINUM LEGS	
H 29.5	Top Shape		Rectangle	30x60	\$2008	2126
				36x72	\$2353	2469
				42x84	\$2759	2877
			L - Table	40x55	\$2181	2299
				46x63	\$2486	2604
				52x72	\$2853	2971
			Round	30D	\$1635	1753
				36D	\$1807	1925
				42D	\$2011	2130
				48D	\$2351	2468
			Oval	30x60	\$2091	2209
				36x72	\$2469	2585
				42x84	\$2916	3035
				48x96	\$3135	3253

**To specify:**

Please refer to pages 3-4 for complete specifying information.

Specify all products by their product code.



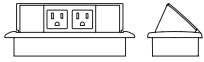

**Power - Flip Top Grommet**

LIST PRICE

2- 110v, 1 USB

\$1027



**Ganging**

LIST PRICE

Link tops frontally or on the side

\$160



**Textile Cable Tray**

LIST PRICE

2- 110v, 1 USB

\$160

**Cable Duct**

LIST PRICE

2- 110v, 1 USB

\$160

To specify:  
Please refer to pages 3-4 for  
complete specifying information.  
Specify all products by their  
product code.



**Front Divider Panel**

LIST PRICE

47.25W

\$854

Divider material is a rigid polyurethane, textured and laquered in your choice of Matte White, Black, or Grey.



**Side Divider Panel**

LIST PRICE

23.5W

\$534

Divider material is a rigid polyurethane, textured and laquered in your choice of Matte White, Black, or Grey.

To specify:  
Please refer to pages 3-4 for  
complete specifying information.  
Specify all products by their  
product code.

---

**5695 Eagle Drive, SE**  
**Grand Rapids,**  
**Michigan 49512**  
**616-975-9260**  
**[lelandfurniture.com](http://lelandfurniture.com)**

# Gemma

## October 2021 Price List



# Gemma

Table of Contents	GM2
Specification Information	GM3
Specification Example	GM4
Sled Base, Birch Shell	GM5
Sled Base, Oak Shell	GM6
Sled Base, Walnut Shell	GM7
Wood Base, Birch	GM8
Wood Base, Oak	GM9
Wood Base, Walnut	GM10

**Chair Model**

DESCRIPTION	CODE
Gemma sled base	GEMS
Gemma sled base, upholstered seat	GEMSU
Gemma sled base, upholstered seat and back	GEMSUU
Gemma wood base	GEMW
Gemma wood base, upholstered seat	GEMWU
Gemma wood base, upholstered seat and back	GEMWUU

**Shell Veneer**

DESCRIPTION	CODE
Birch	B
Oak	O
Walnut	W

**Wood Shell & Wood Base Finishes**

\*Wood bases default to specified shell type

**STANDARD SHELL/LEG (BIRCH):**

DESCRIPTION	CODE
Natural	11
Graphite	25
Transparent Black	29
White Wash II	30
Blue Sky	100M
Forest	101M
Sienna	106M
Willow	108M

**OAK SHELL/LEG:**

DESCRIPTION	CODE
Natural White Oak	12
Morel	66M

**WALNUT SHELL/LEG:**

DESCRIPTION	CODE
Natural Walnut	08M

**Sled Base Finishes**

DESCRIPTION	CODE
Black	B
White	W
Black Textured	BT
White Textured	WT
Matte Mercury	MMR
Matte Mineral	MMn
Matte Burnish	MBN
Matte Foundry	MFN
Matte Blue Sky	MBS
Matte Forest	MFO
Matte Willow	MWL
Matte Sienna	MSN
Chrome	C

**Upholstery Selection**

Please refer to Leland Textile Program which features textiles and leathers from the following partners:

- Camira
- Carnegie
- CF Stinson
- Green Hides
- Maharam
- Unika Vaev

The complete grade list can be found on our website or you can specify COM/COL. Due to the design of this product, it is recommended that all non pre-approved textile be tested for compatibility.

**Glide Type****STANDARD:**

DESCRIPTION	CODE
Nylon	S

**OPTIONAL:**

DESCRIPTION	CODE
Felt	FC

**Stacking note**

The Gemma chair does not stack.

**Specifications required to create the product code**

- Model
- Wood Species
- Shell Finish
- Seat upholstery selection (when applicable)
- Leg Finish
- Back Upholstery Selection (when applicable)
- Glide Type



**MODEL**

Gemma Wood Base Chair (GEMW)

**WOOD SPECIES**

Oak (0)

**SHELL FINISH**

Natural White Oak (12)

**SEAT UPHOLSTERY SELECTION**

When applicable, enter upholstery grade, COM

**LEG FINISH**

Natural White Oak (12)

**SEAT AND/OR BACK UPHOLSTERY SELECTION**

When applicable, enter upholstery grade, COM



GEMMA SLED BASE CHAIR, BIRCH SHELL  
Design: Altherr Désile Park

GM5



Gemma Sled Base Chair	MODEL		LIST PRICE
Birch shell	GEMS-B	Powder Coat	\$920
W 22 D H SH		Chrome	\$975

Optional Felt Glides: Add \$8.00 net per chair for a set of four (4).



Gemma Sled Base Chair	MODEL	LIST PRICE/GRADE	COM/COL	A	B	C	D	E	F	G	H	I	J	K	L
Birch shell, upholstered seat	GEMSU-B	Powder Coat	\$1035	1080	1103	1126	1149	1172	1195	1218	1241	1264	1287	1310	1312
W 22 D H SH		Chrome	\$1090	1135	1158	1181	1204	1227	1250	1273	1296	1319	1342	1365	1388

Optional Felt Glides: Add \$8.00 net per chair for a set of four (4).

COM Yardage: .75 Yard

Contact Leland Customer Experience for yardage requirements on textiles with repeats.

For COL requirements please contact Leland Customer Experience.



Gemma Sled Base Chair	MODEL	LIST PRICE/ GRADE	COM/COL	A	B	C	D	E	F	G	H	I	J	K	L
Birch shell, upholstered seat and back	GEMSUU-B	Powder Coat	\$1155	1210	1264	1318	1372	1426	1480	1534	1588	1642	1696	1750	1804
W 22 D H SH		Chrome	\$1210	1265	1319	1373	1427	1481	1535	1589	1643	1697	1751	1805	1859

Optional Felt Glides: Add \$8.00 net per chair for a set of four (4).

COM Yardage: 1.25 Yards

Contact Leland Customer Experience for yardage requirements on textiles with repeats.

For COL requirements please contact Leland Customer Experience.

Due to the curvature of the chair shell, we are not able to pattern match on the chair back and seat. If a directional fabric is being specified, add \$56 LIST for a pattern match in the center of the seat and back only.

To specify:

Please refer to pages 3-4 for complete specifying information.

Specify all products by their product code.

Pricing Effective: October 2021



GEMMA SLED BASE CHAIR, OAK SHELL  
Design: Altherr Désile Park

GM6



Gemma Sled Base Chair	MODEL		LIST PRICE
Oak shell	GEMS-O	Powder Coat	\$1045
W 22 D H SH		Chrome	\$1100

Optional Felt Glides: Add \$8.00 net per chair for a set of four (4).



Gemma Sled Base Chair	MODEL	LIST PRICE/GRADE	COM/COL	A	B	C	D	E	F	G	H	I	J	K	L
Oak shell, upholstered seat	GEMSU-O	Powder Coat	\$1160	1205	1228	1251	1274	1297	1320	1343	1366	1389	1412	1435	1458
W 22 D H SH		Chrome	\$1215	1260	1283	1306	1329	1352	1375	1398	1421	1444	1467	1490	1513

Optional Felt Glides: Add \$8.00 net per chair for a set of four (4).

COM Yardage: .75 Yard

Contact Leland Customer Experience for yardage requirements on textiles with repeats.

For COL requirements please contact Leland Customer Experience.



Gemma Sled Base Chair	MODEL	LIST PRICE/ GRADE	COM/COL	A	B	C	D	E	F	G	H	I	J	K	L
Oak shell, upholstered seat and back	GEMSUU-O	Powder Coat	\$1280	1335	1389	1443	1497	1551	1605	1659	1713	1767	1821	1875	1929
W 22 D H SH		Chrome	\$1335	1390	1444	1498	1552	1606	1660	1714	1768	1822	1876	1930	1984

Optional Felt Glides: Add \$8.00 net per chair for a set of four (4).

COM Yardage: 1.25 Yards

Contact Leland Customer Experience for yardage requirements on textiles with repeats.

For COL requirements please contact Leland Customer Experience.

Due to the curvature of the chair shell, we are not able to pattern match on the chair back and seat. If a directional fabric is being specified, add \$56 LIST for a pattern match in the center of the seat and back only.

To specify:

Please refer to pages 3-4 for complete specifying information.

Specify all products by their product code.

Pricing Effective: October 2021

GEMMA SLED BASE CHAIR, WALNUT SHELL  
 Design: Altherr Désile Park

GM7



Gemma Sled Base Chair	MODEL		LIST PRICE
Walnut shell	GEMS-W	Powder Coat	\$1220
W 22 D H SH		Chrome	\$1275

Optional Felt Glides: Add \$8.00 net per chair for a set of four (4).



Gemma Sled Base Chair	MODEL	LIST PRICE/GRADE	COM/COL	A	B	C	D	E	F	G	H	I	J	K	L
Walnut shell, upholstered seat	GEMSU-W	Powder Coat	\$1335	1380	1403	1426	1449	1472	1495	1518	1541	1564	1587	1610	1633
W 22 D H SH		Chrome	\$1390	1435	1458	1481	1504	1527	1550	1573	1596	1619	1642	1665	1688

Optional Felt Glides: Add \$8.00 net per chair for a set of four (4).

COM Yardage: .75 Yard

Contact Leland Customer Experience for yardage requirements on textiles with repeats.

For COL requirements please contact Leland Customer Experience.



Gemma Sled Base Chair	MODEL	LIST PRICE/ GRADE	COM/COL	A	B	C	D	E	F	G	H	I	J	K	L
Walnut shell, upholstered seat and back	GEMSUU-W	Powder Coat	\$1455	1510	1564	1618	1672	1726	1731	1785	1839	1893	1947	2001	2055
W 22 D H SH		Chrome	\$1510	1565	1619	1673	1727	1781	1835	1889	1943	1997	2051	2105	2159

Optional Felt Glides: Add \$8.00 net per chair for a set of four (4).

COM Yardage: 1.25 Yard

Contact Leland Customer Experience for yardage requirements on textiles with repeats.

For COL requirements please contact Leland Customer Experience.

Due to the curvature of the chair shell, we are not able to pattern match on the chair back and seat. If a directional fabric is being specified, add \$56 LIST for a pattern match in the center of the seat and back only.

To specify:

Please refer to pages 3-4 for complete specifying information.

Specify all products by their product code.

Pricing Effective: October 2021

GEMMA WOOD BASE CHAIR, BIRCH  
Design: Altherr Désile Park

GM8



Gemma Wood Base Chair	MODEL	LIST PRICE
Birch shell/base	GEMW-B	\$1170
W 22 D 21 H SH 18	Optional Felt Glides: Add \$8.00 net per chair for a set of four (4).	



Gemma Wood Base Chair	MODEL	LIST PRICE/GRADE	COM/COL	A	B	C	D	E	F	G	H	I	J	K	L
Birch shell/base, upholstered seat	GEMWU-B		\$1285	1330	1353	1376	1399	1422	1445	1468	1491	1514	1537	1560	1583
W 22 D 21 H SH 18	Optional Felt Glides: Add \$8.00 net per chair for a set of four (4). COM Yardage: .75 Yard Contact Leland Customer Experience for yardage requirements on textiles with repeats. For COL requirements please contact Leland Customer Experience.														



Gemma Wood Base Chair	MODEL	LIST PRICE/ GRADE	COM/COL	A	B	C	D	E	F	G	H	I	J	K	L
Birch shell/base, upholstered seat and back	GEMWUU-B		\$1395	1450	1504	1558	1612	1666	1720	1774	1828	1882	1936	1990	2044
W 22 D 21 H SH 18	Optional Felt Glides: Add \$8.00 net per chair for a set of four (4). COM Yardage: 1.25 Yards Contact Leland Customer Experience for yardage requirements on textiles with repeats. For COL requirements please contact Leland Customer Experience. Due to the curvature of the chair shell, we are not able to pattern match on the chair back and seat. If a directional fabric is being specified, add \$56 LIST for a pattern match in the center of the seat and back only.														

To specify:  
Please refer to pages 3-4 for complete specifying information.  
Specify all products by their product code.

Pricing Effective: October 2021

GEMMA WOOD BASE CHAIR, OAK  
Design: Altherr Désile Park

GM9



Gemma Wood Base Chair	MODEL	LIST PRICE
Oak shell/base	GEMW-0	\$1295
W 22 D 21 H SH 18	Optional Felt Glides: Add \$8.00 net per chair for a set of four (4).	



Gemma Wood Base Chair	MODEL	LIST PRICE/GRADE	COM/COL	A	B	C	D	E	F	G	H	I	J	K	L
Oak shell/base, upholstered seat	GEMWU-0		\$1410	1455	1478	1501	1524	1547	1570	1593	1616	1639	1662	1685	1708
W 22 D 21 H SH 18	Optional Felt Glides: Add \$8.00 net per chair for a set of four (4). COM Yardage: .75 Yard Contact Leland Customer Experience for yardage requirements on textiles with repeats. For COL requirements please contact Leland Customer Experience.														



Gemma Wood Base Chair	MODEL	LIST PRICE/ GRADE	COM/COL	A	B	C	D	E	F	G	H	I	J	K	L
Oak shell/base, upholstered seat and back	GEMWUU-0		\$1530	1585	1639	1693	1747	1801	1855	1909	1963	2017	2071	2125	2179
W 22 D 21 H SH 18	Optional Felt Glides: Add \$8.00 net per chair for a set of four (4). COM Yardage: 1.25 Yards Contact Leland Customer Experience for yardage requirements on textiles with repeats. For COL requirements please contact Leland Customer Experience. Due to the curvature of the chair shell, we are not able to pattern match on the chair back and seat. If a directional fabric is being specified, add \$56 LIST for a pattern match in the center of the seat and back only.														

To specify:  
Please refer to pages 3-4 for complete specifying information.  
Specify all products by their product code.

Pricing Effective: October 2021

GEMMA WOOD BASE CHAIR, WALNUT  
Design: Altherr Désile Park

GM10



Gemma Wood Base Chair	MODEL	LIST PRICE
Walnut shell/base	GEMW-W	\$1470
W 22 D 21 H SH 18	Optional Felt Glides: Add \$8.00 net per chair for a set of four (4).	



Gemma Wood Base Chair	MODEL	LIST PRICE/GRADE	COM/COL	A	B	C	D	E	F	G	H	I	J	K	L
Walnut shell/base, upholstered seat	GEMWU-W		\$1585	1630	1653	1676	1699	1722	1745	1768	1791	1814	1837	1860	1883
W 22 D 21 H SH 18	Optional Felt Glides: Add \$8.00 net per chair for a set of four (4). COM Yardage: .75 Yard Contact Leland Customer Experience for yardage requirements on textiles with repeats. For COL requirements please contact Leland Customer Experience.														



Gemma Wood Base Chair	MODEL	LIST PRICE/GRADE	COM/COL	A	B	C	D	E	F	G	H	I	J	K	L
Walnut shell/base, upholstered seat and back	GEMWUU-W		\$1705	1760	1814	1868	1922	1976	2030	2084	2136	2192	2246	2300	2354
W 22 D 21 H SH 18	Optional Felt Glides: Add \$8.00 net per chair for a set of four (4). COM Yardage: 1.25 Yards Contact Leland Customer Experience for yardage requirements on textiles with repeats. For COL requirements please contact Leland Customer Experience. Due to the curvature of the chair shell, we are not able to pattern match on the chair back and seat. If a directional fabric is being specified, add \$56 LIST for a pattern match in the center of the seat and back only.														

To specify:  
Please refer to pages 3-4 for complete specifying information.  
Specify all products by their product code.

Pricing Effective: October 2021

---

**5695 Eagle Drive, SE**  
**Grand Rapids,**  
**Michigan 49512**  
**616-975-9260**  
**[lelandfurniture.com](http://lelandfurniture.com)**

# Gemma Stitch

## August 2022 Price List



# Gemma Stitch

Table of Contents	GS2
Specification Information	GS3
Specification Example	GS4
Gemma Stitch	GS5
Gemma Stitch Handle	GS5
Gemma Stitch Return Swivel	GS5



## Chair Model

---

DESCRIPTION	CODE
Gemma Stitch	GEML

## Upholstery Selection

---

Please refer to Leland Textile Program which features textiles and leathers from the following partners:

- Camira
- Green Hides
- Carnegie
- Maharam
- CF Stinson
- Unika Vaev

The complete grade list can be found at Leland's website or you can specify COM/COL. Due to the design of this product, it is recommended that all non pre-approved textile be tested for compatibility.

## Optional

---

DESCRIPTION	CODE
Gemma Stitch Handle	GH
Gemma Stitch Return Swivel	RS

\*Handle not available on return swivel base model

## Product Weight

---

DESCRIPTION	LBS
Gemma Stitch Wood Base	39

**Specifications required to create the product code**

- Model
- Upholstery Selection
- Handle (If Applicable)



**MODEL**

Gemma Stitch (GEML)

**UPHOLSTERY SELECTION**

Enter upholstery grade or COM

**GEMMA STITCH HANDLE**

When applicable, enter GH



GEMMA STITCH  
Design: Altherr Désile Park

GS5

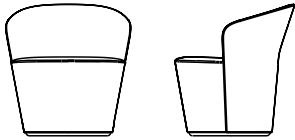

**Gemma Stitch**

W 24.5 D 26 H 30  
SH 18

MODEL	LIST PRICE/ GRADE	COM/COL	A	B	C	D	E	F	G	H	I	J	K	L
GEML		\$2325	2475	2573	2671	2769	2884	2999	3114	3244	3374	3504	3634	3764

COM Yardage: 3.25 Yards  
Contact Leland Customer Experience for yardage requirements on textiles with repeats.  
For COL requirements please contact Leland Customer Experience.

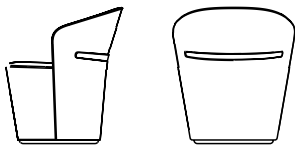

**Gemma Stitch Handle**

MODEL	LIST PRICE
GH	\$45



**Gemma Stitch,  
Return Swivel Base**

W 24.5 D 26 H 30  
SH 18

MODEL	LIST PRICE/ GRADE	COM/COL	A	B	C	D	E	F	G	H	I	J	K	L
GEML-RS		\$2536	2686	2784	2882	2980	3095	3210	3325	3455	3585	3715	3845	3975

COM Yardage: 3.25 Yards  
Contact Leland Customer Experience for yardage requirements on textiles with repeats.  
For COL requirements please contact Leland Customer Experience.

To specify:  
Please refer to pages 3-4 for complete specifying information.  
Specify all products by their product code.

---

**5695 Eagle Drive, SE  
Grand Rapids,  
Michigan 49512  
616-975-9260  
lelandfurniture.com**

# Gemma Table

## August 2022 Price List



# Gemma Table

Table of Contents	GT2
Visual Reference	GT3
Specification Information	GT4
Specification Example	GT5
Power Planning	GT6
Totem Base	GT7
Wood Base	GT7

TABLE MODEL		TOP SIZES & HEIGHT	BASE	PAGE
Totem Base (GETT)		42 DIA, 29H 48 DIA, 29H	Powder Coat	Page GT7

TABLE MODEL		TOP SIZES & HEIGHT	BASE	PAGE
Wood Base, Round Top (GETD)		42 DIA, 29H 48 DIA, 29H	Beech Walnut Oak	Page GT7

TABLE MODEL		TOP SIZES & HEIGHT	BASE	PAGE
Wood Base, Soft Square Top (GETD)		42x42, 29H 48x48, 29H	Beech Walnut Oak	Page GT7

TABLE MODEL		TOP SIZES & HEIGHT	BASE	PAGE
Wood Base, Soft Rectangle Top (GETD)		60x36, 29H 72x36, 29H 84x42, 29H 96x42, 29H	Beech Walnut Oak	Page GT7

**Model**

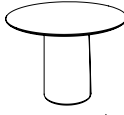
DESCRIPTION	CODE
Gemma table, totem base	GETT
Gemma table, wood base	GETD

**Top Size & Base Height**

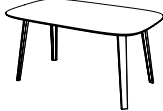
**TOTEM BASE:**

DESCRIPTION	CODE
42D, 29H	42D
48D, 29H	48D

**WOOD BASE:**

DESCRIPTION	CODE
42x42, 29H	4242
42D, 29H	42D
48x48, 29H	4848
48D, 29H	48D
60x36, 29H	6036
72x36, 29H	7236
84x42, 29H	8442
96x42, 29H	9642

**Top Material**

**WOOD**

DESCRIPTION	CODE
Beech	B
Oak	O
Walnut	W
Forbo	F
Laminate	L

**Top & Wood Base Finishes**

\*Wood bases default to specified top type except Laminate and Forbo which pair with Beech bases, unless otherwise specified.

**BEECH FINISH OPTIONS**

DESCRIPTION	CODE
Natural	11
Graphite	25
Transparent Black	29
White Wash II	30
Blue Sky	100M
Forest	101M
Sienna	106M
Willow	108M

**OAK FINISH OPTIONS**

DESCRIPTION	CODE
Natural White Oak	12
Morel	66M

**WALNUT FINISH OPTIONS**

DESCRIPTION	CODE
Natural Walnut	08M

**FORBO FINISH OPTIONS**

DESCRIPTION	CODE
Smokey Blue	4179
Powder	4185
Pebble	4175
Olive	4184
Mauve	4172

**LAMINATE FINISH OPTIONS**

DESCRIPTION	CODE
Designer White Wilsonart	D354-60
Black Pionite	SE101
Platinum Wilsonart	D315-60

**Totem Base Finishes**

DESCRIPTION	CODE
Black	B
White	W
Black Textured	BT
White Textured	WT
Matte Mercury	MMR
Matte Mineral	MMN
Matte Burnish	MBN
Matte Foundry	MFN
Matte Blue Sky	MBS
Matte Forest	MFO
Matte Willow	MWL
Matte Sienna	MSN

**Power Option**

1 Simplex, 1 USB A+C

DESCRIPTION	CODE
Edge Mounted, White	PEM-W
Edge Mounted, Black	PEM-B
In-Surface, White	PIS-W
In-Surface, Black	PIS-B

\*Totem base models with power must choose from in-surface power options

**Edge Types**

DESCRIPTION	CODE
Wood Edge	W7
Flat PVC Edge	V6

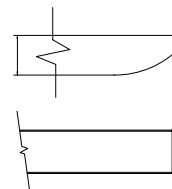

\*W7 edge on Beech, Oak, Walnut, and Forbo tops only.

^V6 edge on Laminate tops only.



**Specifications required to create the product code**

- Model
- Top Size
- Top Type
- Top Finish
- Base Finish
- Power Option (Optional)



**MODEL**

Gemma Table, Wood Base (GETD)

**TOP SIZE**

42 DIA (42D)

**TOP TYPE**

Oak (0)

**TOP FINISH**

Natural White Oak (12)

**BASE HEIGHT**

29 Inches

**BASE FINISH**

Natural White Oak (12)



**Options**

- 1 Simplex, 1 USB A+C, braided cord
- Edge Mounted and In-Surface options available on Wood Base Models
- In-Surface options available on Totem Base Models
- Cord Length: Differs based on table size. All tables will have approximately 2' of additional cord from the base of the leg.

**Edge Mounted Power**



**Wire Management**



**In-Surface Power**

**Gemma Table,  
Power Options**

	MODEL	LIST PRICE
1 Simplex, 1 USB A+C Braided Cord	PEM-W Edge Mounted, White	\$168
	PEM-B Edge Mounted, Black	\$168
	PIS-W In-Surface, White	\$275
	PIS-B In Surface, Black	\$275

GEMMA TABLE  
Design: Altherr Désile Park

GT7

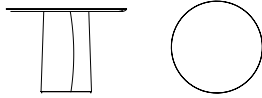

**Gemma Table,  
Totem Base**

	MODEL	BASE	LAMINATE TOP	BEECH TOP	OAK TOP	WALNUT TOP	FORBO TOP
42" DIA, 29" Height	GETT-42D	Powder Coat	\$3532	3789	3876	3876	3876
48" DIA, 29" Height	GETT-48D	Powder Coat	\$3846	4102	4190	4190	4190

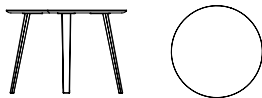

**Gemma Table,  
Wood Base**

	MODEL	BASE	LAMINATE TOP	BEECH TOP	OAK TOP	WALNUT TOP	FORBO TOP
42" DIA, 29" Height	GETD-42D	Wood Base	\$2926	3183	3269	3269	3269
48" DIA, 29" Height	GETD-48D	Wood Base	\$3240	3497	3585	3585	3585

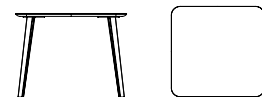

**Gemma Table,  
Wood Base**

	MODEL	BASE	LAMINATE TOP	BEECH TOP	OAK TOP	WALNUT TOP	FORBO TOP
42"x42", 29" Height	GETD-4242	Wood Base	\$2926	3183	3269	3269	3269
48"x48", 29" Height	GETD-4848	Wood Base	\$3240	3497	3585	3585	3585



**Gemma Table,  
Wood Base**

	MODEL	BASE	LAMINATE TOP	BEECH TOP	OAK TOP	WALNUT TOP	FORBO TOP
60"x36", 29" Height	GETD-6036	Wood Base	\$3602	3859	3947	3947	3947
72"x36", 29" Height	GETD-7236	Wood Base	\$3966	4223	4309	4309	4309
84"x42", 29" Height	GETD-8442	Wood Base	\$4616	4873	4959	4959	4959
96"x42", 29" Height	GETD-9642	Wood Base	\$4724	4981	5067	5067	5067

To specify:

Please refer to pages 3-5 for complete specifying information.

Specify all products by their product code.

Pricing Effective: August 2022

---

**5695 Eagle Drive, SE  
Grand Rapids,  
Michigan 49512  
616-975-9260  
lelandfurniture.com**

# Gemma Occasional Table

August 2022 Price List



# Gemma Occasional Table

Table of Contents	GT2
Visual Reference	GT3
Specification Information	GT4
Specification Example	GT5
Power Planning	GT6
Sled Base	GT7
Wood Base	GT7
Totem Base	GT8
Height Adjustable Base	GT8

TABLE MODEL		TABLE TOP SIZES & BASE HEIGHT	BASE	PAGE
Sled Base (GETS)		32 DIA, 18H	Powder Coat	Page GT6
		20 DIA, 22H		
		20 DIA, 26H		

TABLE MODEL		TABLE TOP SIZES	BASE	PAGE
Wood Base (GETW)		32 DIA, 15H	Birch	Page GT6
		32 DIA, 18H	Walnut	
		20 DIA, 22H	Oak	
		20 DIA, 26H	Painted Wood	

TABLE MODEL		TABLE TOP SIZES	BASE	PAGE
Totem Base (GETT)		32 DIA, 15H	Powder Coat	Page GT6
		32 DIA, 18H		
		20 DIA, 22H		
		20 DIA, 26H		

TABLE MODEL		TABLE TOP SIZES	BASE	PAGE
Height Adjustable (GETH)		32 DIA, 23-29H	Powder Coat	Page GT6

**Model**

DESCRIPTION	CODE
Gemma occasional table, sled base	GETS
Gemma occasional table, wood base	GETW
Gemma occasional table, totem base	GETT
Gemma occasional table, height adjustable base	GETH

**Top Size & Base Height**

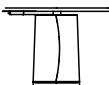
**SLED BASE:**

DESCRIPTION	CODE
32D, 15H	3215
32D, 18H	3218
20D, 22H	2022
20D, 26H	2026

**WOOD BASE:**

DESCRIPTION	CODE
32D, 15H	3215
32D, 18H	3218
20D, 22H	2022
20D, 26H	2026

**TOTEM BASE:**

DESCRIPTION	CODE
32D, 15H	3215
32D, 18H	3218
20D, 22H	2022
20D, 26H	2026

**HEIGHT ADJUSTABLE BASE:**

DESCRIPTION	CODE
32D, 23-29H	3229

**Top Type**

**WOOD**

DESCRIPTION	CODE
Birch	B
Oak	O
Walnut	W
Painted Wood	P

**Top & Wood Base Finishes**

\*Wood bases default to specified top type except Painted Tops which pair with oak bases.

**BIRCH FINISH OPTIONS**

DESCRIPTION	CODE
Natural	11
Graphite	25
Transparent Black	29
White Wash II	30
Blue Sky	100M
Forest	101M
Sienna	106M
Willow	108M

**OAK FINISH OPTIONS**

DESCRIPTION	CODE
Natural White Oak	12
Morel	66M

**WALNUT FINISH OPTIONS**

DESCRIPTION	CODE
Natural Walnut	08M

**TEXTURED PAINT (TOPS ONLY)**

DESCRIPTION	CODE
White	WT
Black	BT

**Sled & Totem Base Finishes**

DESCRIPTION	CODE
Black	B
White	W
Black Textured	BT
White Textured	WT
Matte Mercury	MMR
Matte Mineral	MMN
Matte Burnish	MBN
Matte Foundry	MFN
Matte Blue Sky	MBS
Matte Forest	MFO
Matte Willow	MWL
Matte Sienna	MSN
Chrome (Sled Base Only)	C

**Power Option**

DESCRIPTION	CODE
Dual USB Unit	USB

\*Available only on 22H and 26H Totem Base



## Specifications required to create the product code

- Model
- Top Size
- Top Type
- Top Finish
- Base Height
- Base Finish



### MODEL

Height Adjustable (GETH)

### TOP SIZE

32 DIA (32)

### TOP TYPE

Oak (0)

### TOP FINISH

Natural White Oak (12)

### BASE HEIGHT

23-29" (29)

### BASE FINISH

Matte Willow Powder Coat (MWL)



**Options**

- Dual USB Unit (USB), standard cord

\*Available only on 22H and 26H Totem Base



**Dual USB**



**Gemma Occasional Table,  
Power Options**

	MODEL	LIST PRICE
Available on 22" Height and 26" Height Totem Base	USB Dual USB Unit	\$213

GEMMA OCCASIONAL TABLE  
Design: Altherr Désile Park

GT7



**Gemma Occasional Table,  
Sled Base**

	MODEL		TEXTURED PAINT TOP	BIRCH TOP	OAK TOP	WALNUT TOP
32" DIA, Up Edge 15" Height	GETS-3215	Powder Coat	\$1050	1140	1245	1350
	GETS-3215	Chrome	\$1214	1318	1438	1559
32" DIA Top, Up Edge 18" Height	GETS-3218	Powder Coat	\$1100	1190	1295	1400
	GETS-3218	Chrome	\$1264	1368	1488	1609
20" DIA Top, Waterfall Edge 22" Height	GETS-2022	Powder Coat	\$670	710	760	805
	GETS-2022	Chrome	\$770	816	873	925
20" DIA Top, Waterfall Edge 26" Height	GETS-2026	Powder Coat	\$900	950	1100	1250
	GETS-2026	Chrome	\$1034	1092	1264	1437



**Gemma Occasional Table,  
Wood Base**

	MODEL		TEXTURED PAINT TOP, OAK BASE	BIRCH TOP, BIRCH BASE	OAK TOP, OAK BASE	WALNUT TOP, WALNUT BASE
32" DIA Top, Up Edge 15" Height	GETW-3215	Wood Base	\$1190	1260	1370	1480
32" DIA Top, Waterfall Edge 18" Height	GETW-3218	Wood Base	\$1140	1210	1320	1430
20" DIA Top, Waterfall Edge 22" Height	GETW-2022	Wood Base	\$705	745	795	840
20" DIA Top, Waterfall Edge 26" Height	GETW-2026	Wood Base	\$1050	1100	1300	1500

**To specify:**  
Please refer to pages 3-5 for complete specifying information.  
Specify all products by their product code.

**Pricing Effective: August 2022**

GEMMA OCCASIONAL TABLE  
Design: Altherr Désile Park

GT8



**Gemma Occasional Table,  
Totem Base**

	MODEL		TEXTURED PAINT TOP	BIRCH TOP	OAK TOP	WALNUT TOP
32" DIA Top, Up Edge 18" Height	GETT-3215	Powder Coat	\$1192	1282	1342	1402
32" DIA Top, Up Edge 18" Height	GETT-3218	Powder Coat	\$1300	1390	1450	1510
20" DIA Top, Waterfall Edge 22" Height	GETT-2022	Powder Coat	\$755	795	940	1085
20" DIA Top, Waterfall Edge 26" Height	GETT-2026	Powder Coat	\$1350	1400	1525	1650

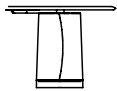

**Gemma Occasional Table,  
Height Adjustable**

	MODEL		TEXTURED PAINT TOP	BIRCH TOP	OAK TOP	WALNUT TOP
32" DIA Top, Waterfall Edge 23" - 29" Height Adjustable	GETH-3229	Powder Coat	\$2530	2620	2680	2740

**To specify:**  
Please refer to pages 3-5 for complete specifying information.  
Specify all products by their product code.

**Pricing Effective: August 2022**

---

**5695 Eagle Drive, SE  
Grand Rapids,  
Michigan 49512  
616-975-9260  
lelandfurniture.com**

# Hammok

## February 2022 Price List



# Hammok

Table of Contents	HS2
Specification Information	HS3
Specification Example	HS4
Cantilever Chair	HS5
Cantilever Chair, Upholstered Onlay	HS5

**Chair Model**

DESCRIPTION	CODE
Hammok cantilever chair	HC
Hammok cantilever chair, upholstered onlay	HCU

**Shell Finish****STANDARD LELAND COLORS****CUSTOM** Specify Custom (01)

\*Please note that Hammok is NOT AVAILABLE in the following finishes:  
Natural Walnut Matte (08M), Natural (11), Natural White Oak Matte (12M)

**Frame Finish**

DESCRIPTION	CODE
Sterling	ST
Warm Grey	WG
Cool Grey	CG
Black	B
White	W
Matte Gold Rush	MGR
Matte Mercury	MMR
Matte Mineral	MMN
Matte Burnish	MBN
Matte Foundry	MFN
Brushed Stainless Steel (Cantilever only)	BSS

**Upholstered Onlay Selection**

Please refer to Leland Textile Program which features textiles and leathers from the following partners:

- Camira
- Carnegie
- CF Stinson
- Green Hides
- Maharam
- Unika Vaev

The complete grade list can be found on our website or you can specify COM/COL. Due to the design of this product, it is recommended that all non pre-approved textile be tested for compatibility.

**Arm Finish**

Black molded ABS

**Glide Type****STANDARD**

DESCRIPTION	CODE
Nylon (Cantilever only)	S

**Freight Note**

Due to the size and nature of Hammok chairs, the Freight Program does not apply to this product. Please contact Customer Experience for a quote.



**Specifications required to create the product code**

- Model
- Shell Finish
- Frame Finish
- Upholstered Onlay Selection (when applicable)
- Glide Type



**MODEL**

Hammok Cantilever, upholstered onlay (HCU)

**SHELL FINISH**

Natural (11)

**FRAME FINISH**

Sterling (ST)

**UPHOLSTERED ONLAY SELECTION**

When applicable, enter upholstery grade, COM or COL.  
Grade J (J)



**HAMMOK CANTILEVER CHAIR**  
Design: Burkhard Vogtherr

**HS5**

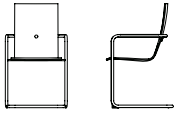

Hammok Cantilever Chair	MODEL	LIST PRICE
Powder coat frame	HC - ___	\$1016
W 22 D 22 H 34.5 SH 17.75 AH 25.875		

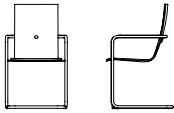

Hammok Cantilever Chair	MODEL	LIST PRICE
Brushed stainless steel frame	HC-BSS	\$1223
W 22 D 22 H 34.5 SH 17.75 AH 25.875		

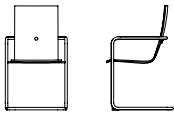

Hammok Cantilever	MODEL	LIST PRICE/ GRADE	COM/ COL	A	B	C	D	E	F	G	H	I	J	K	L
Powder coat frame, upholstered only	HCU - ___	\$1097	1163	1196	1228	1261	1293	1327	1360	1392	1425	1457	1491	1523	
COM Yardage: 1 or 2 chairs: 1.25 yards; 3 or 4 chairs: 2.5 yards Contact Leland Customer Experience for yardage requirements on textiles with repeats. For COL requirements please contact Leland Customer Experience.															
W 22 D 22 H 34.5 SH 17.75 AH 25.875															

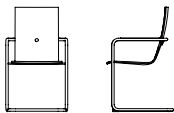

Hammok Cantilever	MODEL	LIST PRICE/ GRADE	COM/ COL	A	B	C	D	E	F	G	H	I	J	K	L
brushed stainless steel frame, upholstered only	HCU-BSS	\$1439	1505	1538	1570	1603	1635	1669	1701	1734	1766	1799	1833	1865	
COM Yardage: 1 or 2 chairs: 1.25 yards; 3 or 4 chairs: 2.5 yards Contact Leland Customer Experience for yardage requirements on textiles with repeats. For COL requirements please contact Leland Customer Experience.															
W 22 D 22 H 34.5 SH 17.75 AH 25.875															

**To specify:**  
Please refer to pages 3-4 for complete specifying information.  
Specify all products by their product code.

---

**5695 Eagle Drive, SE  
Grand Rapids,  
Michigan 49512  
616-975-9260  
lelandfurniture.com**

# Handy Stool

## February 2022 Price List



# Handy Stool

Table of contents	HA2
Specification Information	HA3
Specification Example	HA4
Handy Stool	HA5
Transport/Stacking Dolly	HA8

## Model

DESCRIPTION	CODE
Handy Polypropylene	HYS-P
Handy Polypropylene Shell, Upholstered Onlay	HYS-U
Handy Polypropylene Shell, Wood Onlay	HYS-W
Handy Stool Transport Dolly, Single	HYD-S
Handy Stool Transport Dolly, Double	HYD-D

## Shell Finish/Color

### POLYPROPYLENE SHELL:

DESCRIPTION	CODE
White	WT
Recycled Black	RB
Grey	G
Pistachio	PS

### CUSTOM POLYPROPYLENE COLORS

Custom color match is available upon request. Please contact [hello@lelandfurniture.com](mailto:hello@lelandfurniture.com) for further information.

## Upholstered Onlay Selection

Please refer to Leland Textile Program which features textiles and leathers from the following partners:

- Camira
- Green Hides
- Carnegie
- Maharam
- CF Stinson
- Unika Vaev

The complete grade list can be found on our website or you can specify COM/COL. Due to the design of this product, it is recommended that all non pre-approved textiles be tested for compatibility.

## Wood Onlay Selection

DESCRIPTION	CODE
Natural Walnut	08M
Natural White Oak	12

**LELAND COLORS** (on maple)

## Stacking Note

For Handy, ALL models stack as follows: (including upholstered and wood onlay)



Stack of 10: 44"H  
Stack of 5: 29.5"H

## Product Weight

DESCRIPTION	LBS
Handy Polypropylene - HYS-P	7
Handy Polypropylene Shell, Upholstered Onlay - HYS-U	8
Handy Polypropylene Shell, Wood Onlay - HYS-W	8

**Specifications required to create the product code**

- Model
- Shell Finish
- Wood Finish Species (when applicable)
- Wood Finish Code (when applicable)
- Upholstery Option (when applicable)

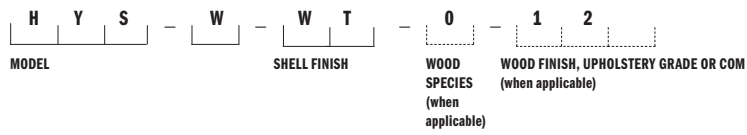

**MODEL**

Handy Stool (HYS)

**ONLAY SELECTION**

Wood (W)

**SPECIES**

Natural White Oak (12)

**UPHOLSTERED ONLAY SELECTION**

When applicable, enter upholstery grade, COM

**POLYPROPYLENE SHELL FINISH**

White (W)



# HANDY STOOL

Design: Stephen Philips (ARUP), licensed by Sellex

# HA5



## PRICING FOR QUANTITIES 1-49

<b>Handy Stool</b>	<b>MODEL</b>	<b>LIST PRICE</b>
Polypropylene shell	HYS-P	\$244
W 16 D 14.5 H 17.5		



## PRICING FOR QUANTITIES 50-99

<b>Handy Stool</b>	<b>MODEL</b>	<b>LIST PRICE</b>
Polypropylene shell	HYS-P	\$200
W 16 D 14.5 H 17.5		

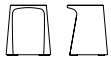

## PRICING FOR QUANTITIES 100+

<b>Handy Stool</b>	<b>MODEL</b>	<b>LIST PRICE</b>
Polypropylene shell	HYS-P	\$178
W 16 D 14.5 H 17.5		

**To specify:**

**Please refer to pages 3-4 for complete specifying information. Specify all products by their product code.**

**Pricing Effective: February 2022**



# HANDY STOOL

Design: Stephen Philips (ARUP), licensed by Sellex

# HA6



### PRICING FOR QUANTITIES 1-49

#### Handy Stool

polypropylene shell,  
upholstered seat onlay

W 16 D 14.5 H 18.25

MODEL	LIST PRICE/GRADE	COM/COL	A	B	C	D	E	F	G	H	I	J	K	L
HYS-U		\$357	380	391	402	413	424	435	446	457	468	479	490	501

COM Yardage: 1 or 2 seats: .75 yard; 3 or 4 seats: 1.5 yards; 5 or 6 seats: 2.25 yards  
Contact Leland Customer Experience for yardage requirements on textiles with repeats.  
For COL requirements please contact Leland Customer Experience.



### PRICING FOR QUANTITIES 50-99

#### Handy Stool

polypropylene shell,  
upholstered seat onlay

W 16 D 14.5 H 18.25

MODEL	LIST PRICE/GRADE	COM/COL	A	B	C	D	E	F	G	H	I	J	K	L
HYS-U		\$313	335	346	357	367	378	389	399	410	421	431	442	453

COM Yardage: 1 or 2 seats: .75 yard; 3 or 4 seats: 1.5 yards; 5 or 6 seats: 2.25 yards  
Contact Leland Customer Experience for yardage requirements on textiles with repeats.  
For COL requirements please contact Leland Customer Experience.



### PRICING FOR QUANTITIES 100+

#### Handy Stool

polypropylene shell,  
upholstered seat onlay

W 16 D 14.5 H 18.25

MODEL	LIST PRICE/GRADE	COM/COL	A	B	C	D	E	F	G	H	I	J	K	L
HYS-U		\$291	314	325	335	346	357	367	378	389	399	410	421	431

COM Yardage: 1 or 2 seats: .75 yard; 3 or 4 seats: 1.5 yards; 5 or 6 seats: 2.25 yards  
Contact Leland Customer Experience for yardage requirements on textiles with repeats.  
For COL requirements please contact Leland Customer Experience.

To specify:

Please refer to pages 3-4 for complete specifying information.  
Specify all products by their product code.

Pricing Effective: February 2022

# HANDY STOOL

Design: Stephen Philips (ARUP), licensed by Sellex

# HA7



## PRICING FOR QUANTITIES 1-49

### Handy Stool

MODEL

LIST PRICE

Wood onlay

HYS-W

\$385

W 16 D 14.5 H 18.5



## PRICING FOR QUANTITIES 50-99

### Handy Stool

MODEL

LIST PRICE

Wood onlay

HYS-W

\$341

W 16 D 14.5 H 18.5



## PRICING FOR QUANTITIES 100+

### Handy Stool

MODEL

LIST PRICE

Wood onlay

HYS-W

\$319

W 16 D 14.5 H 18.5

#### To specify:

Please refer to pages 3-4 for complete specifying information. Specify all products by their product code.

Pricing Effective: February 2022

# HANDY STOOL DOLLY

Design: Stephen Philips (ARUP), licensed by Sellex

# HA8



Handy Stool	MODEL	LIST PRICE
Single	HYD-S	\$773
W 20.75 D 20.75 H 3.75	*Product stacks 10 high on a single dolly.	



Handy Stool	MODEL	LIST PRICE
Double	HYD-D	\$1081
W 37 D 20.75 H 3.75	*Product stacks 10 high, 2 stacks on a double dolly.	

To specify:  
Please refer to pages 3-4 for complete specifying information.  
Specify all products by their product code.

Pricing Effective: February 2022

---

**5695 Eagle Drive, SE**  
**Grand Rapids,**  
**Michigan 49512**  
**616-975-9260**  
**[lelandfurniture.com](http://lelandfurniture.com)**

# Leah Table

## February 2022 Price List

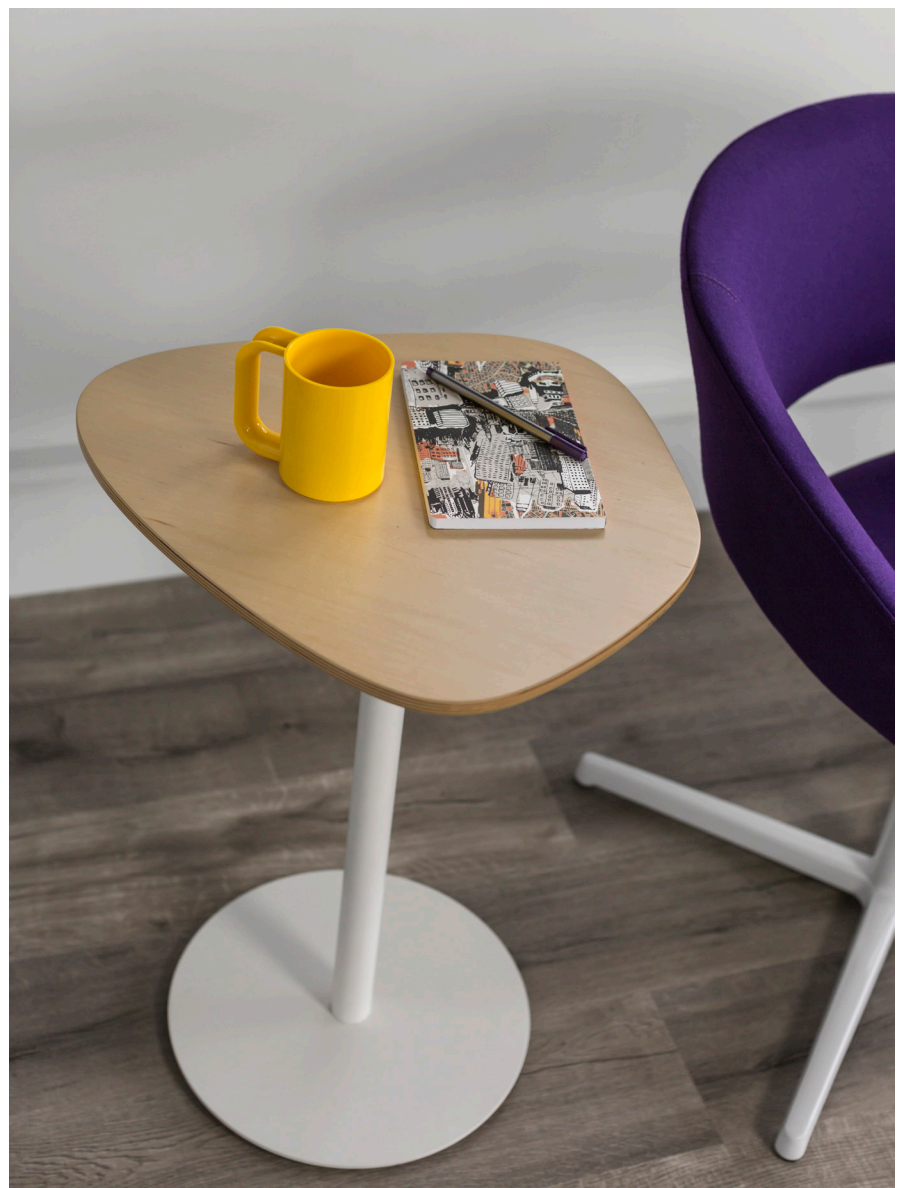

# Leah Table

Table of Contents	LT2
Visual Reference	LT3
Specification Information	LT4
Specification Example	LT5
Ripple Table	LT6
Pond Table	LT7
Puddle Table	LT8
Soft Square Table	LT9
Round Table	LT10

TABLE MODEL		TABLE TOP SIZES	BASE	PAGE
Ripple (LTRP)		18x18 22x22 24x24 30x30	Powder Coat	Page LT6

TABLE MODEL		TABLE TOP SIZES	BASE	PAGE
Pond (LTPN)		22.5x15 45x30	Powder Coat	Page LT7



TABLE MODEL		TABLE TOP SIZES	BASE	PAGE
Puddle (LTPL)		22.5x15 45x30	Powder Coat	Page LT8

TABLE MODEL		TABLE TOP SIZES	BASE	PAGE
Soft Square (LTSS)		18x18 24x24 30x30	Powder Coat	Page LT9

**Model**

DESCRIPTION	CODE
Ripple	LTRP
Pond	LTPN
Puddle	LTPL
Soft Square	LTSS
Round	LTRD

**Top Size****RIPPLE: POND/PUDDLE:**

DESCRIPTION	CODE	DESCRIPTION	CODE
18x18	1818	22.5x15	2315
22x22	2222	45x30	4530
24x24	2424		
30x30	3030		

**SOFT SQUARE: ROUND:**

DESCRIPTION	CODE	DESCRIPTION	CODE
18x18	1818	18D	18D
24x24	2424	24D	24D
30x30	3030	30D	30D

**Top Finish****LELAND COLORS**

DESCRIPTION	CODE
Ash	A
Walnut	W

**TEXTURED PAINT**

DESCRIPTION	CODE
White	WT
Black	BT
Grey	GT

**SOLID SURFACE**

DESCRIPTION	CODE
Cameo White Corian®	CW
Silverite Corian®	CG
Nocturne Corian®	CB

**BACK PAINTED GLASS**

DESCRIPTION	CODE
White	WG
Black	BG

**LAMINATE**

DESCRIPTION	CODE
Maple Laminate	LMP
Walnut Laminate	LWN
Black Laminate	LBK
White Laminate	LWH

**Base Height**

DESCRIPTION	CODE
14"	14H
18"	18H
22"	22H
28" (Available with 18x18 Ripple, 18x18 Soft Square, and 18D and 24D Round Tops only)	28H

**Base Finish**

DESCRIPTION	CODE	DESCRIPTION	CODE
White Textured	WT	Grey Textured	GT
Black Textured	BT	Sterling	ST

**Glide Type**

DESCRIPTION
Black HDPE Glide Plate

**Edge Type**

DESCRIPTION	DESCRIPTION
6mm Glass Top	1/2" Wood Top
1/2" Laminate Top	1/2" Solid Surface Top

**Edge Options****LAMINATE EDGE FINISH**

DESCRIPTION	CODE
Natural 11	



**Specifications required to create the product code**

- Model
- Top Size
- Top Finish
- Edge Type
- Edge Finish
- Base Height
- Base Finish



**MODEL**

Ripple (LTRP)

**TOP SIZE**

24x24 (2424)

**TOP FINISH**

Silverite Corian® (CG)

**EDGE TYPE**

Not applicable

**EDGE FINISH**

Not applicable

**BASE HEIGHT**

22" Base (22H)

**BASE FINISH**

Grey Textured Powder coat (GT)

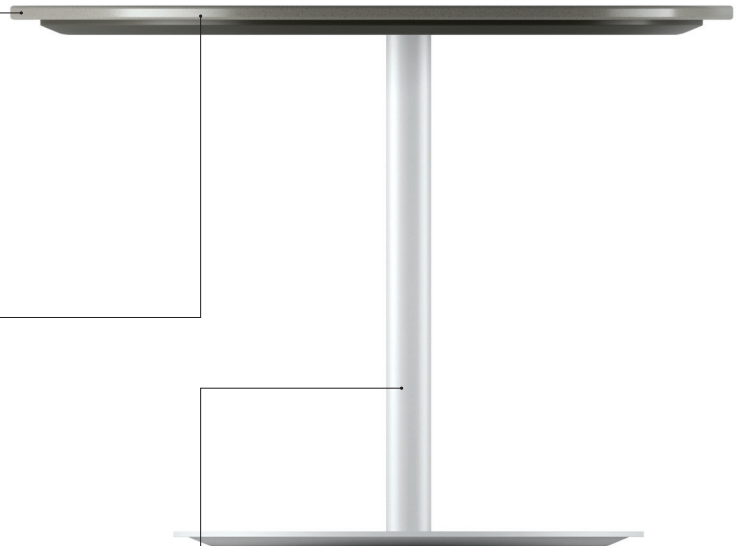

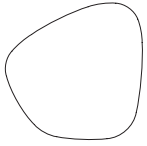

**18" Ripple,**

**Powder Coat Base**

	MODEL	TOP FINISH	TEXTURED PAINT	MAPLE	ASH	WALNUT	LAMINATE	BLACK PAINTED GLASS	SOLID SURFACE
18x18" Top	LTRP-1818	14" Base	\$956	1053	1053	1104	1161	1300	1325
		18" Base	\$965	1060	1060	1112	1172	1309	1335
		22" Base	\$975	1069	1069	1121	1182	1316	1344
		28" Base	\$995	1089	1089	1139	1200	1326	1354

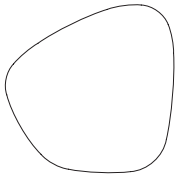

**22" Ripple,**

**Powder Coat Base**

	MODEL	TOP FINISH	TEXTURED PAINT	MAPLE	ASH	WALNUT	LAMINATE	BLACK PAINTED GLASS	SOLID SURFACE
22x22" Top	LTRP-2222	14" Base	\$1050	1152	1152	1216	1274	1618	1649
		18" Base	\$1058	1160	1160	1225	1283	1626	1660
		22" Base	\$1065	1171	1171	1234	1294	1634	1667

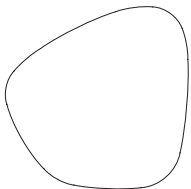

**24" Ripple,**

**Powder Coat Base**

	MODEL	TOP FINISH	TEXTURED PAINT	MAPLE	ASH	WALNUT	LAMINATE	BLACK PAINTED GLASS	SOLID SURFACE
24x24" Top	LTRP-2424	14" Base	\$1137	1248	1248	1315	1333	1734	1768
		18" Base	\$1143	1256	1256	1324	1341	1742	1777
		22" Base	\$1151	1265	1265	1334	1350	1751	1787

To specify:

Please refer to pages 4-5 for complete specifying information.

Specify all products by their product code.

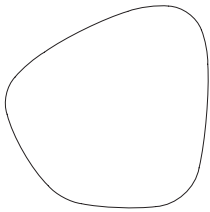

**30" Ripple,  
Powder Coat Base**

	MODEL	TOP FINISH	TEXTURED PAINT	MAPLE	ASH	WALNUT	LAMINATE	BLACK PAINTED GLASS	SOLID SURFACE
30x30" Top	LTRP-3030	14" Base	\$1277	1401	1401	1485	1546	2248	2293
		18" Base	\$1284	1412	1412	1496	1553	2257	2302
		22" Base	\$1294	1421	1421	1504	1562	2264	2311

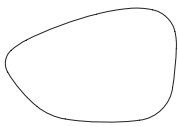

**22.5" Pond,  
Powder Coat Base**

	MODEL	TOP FINISH	TEXTURED PAINT	MAPLE	ASH	WALNUT	LAMINATE	BLACK PAINTED GLASS	SOLID SURFACE
22.5x15" Top	LTPN-2315	14" Base	\$1061	1166	1166	1230	1355	1689	1719
		18" Base	\$1069	1174	1174	1238	1362	1694	1726
		22" Base	\$1075	1183	1183	1248	1373	1705	1737

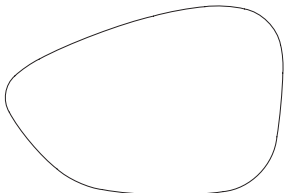

**45" Pond,  
Powder Coat Base**

	MODEL	TOP FINISH	TEXTURED PAINT	MAPLE	ASH	WALNUT	LAMINATE	BLACK PAINTED GLASS	SOLID SURFACE
45x30" Top	LTPN-4530	14" Base	\$1666	1830	1830	1938	2017	3091	3152
		18" Base	\$1674	1837	1837	1947	2027	3099	3162
		22" Base	\$1680	1848	1848	1955	2036	3107	3170

To specify:  
Please refer to pages 4-5 for complete specifying information.  
Specify all products by their product code.

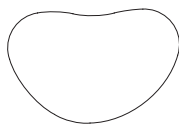

**22.5" Puddle,**

<b>Powder Coat Base</b>	<b>MODEL</b>	<b>TOP FINISH</b>	<b>TEXTURED PAINT</b>	<b>MAPLE</b>	<b>ASH</b>	<b>WALNUT</b>	<b>LAMINATE</b>	<b>BLACK PAINTED GLASS</b>	<b>SOLID SURFACE</b>
22.5x15" Top	LTPL-2315	14" Base	\$1061	1166	1166	1230	1355	1689	1719
		18" Base	\$1069	1174	1174	1238	1362	1694	1726
		22" Base	\$1075	1183	1183	1248	1373	1705	1737

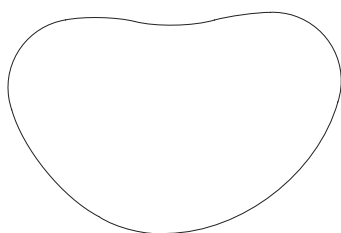

**45" Puddle,**

<b>Powder Coat Base</b>	<b>MODEL</b>	<b>TOP FINISH</b>	<b>TEXTURED PAINT</b>	<b>MAPLE</b>	<b>ASH</b>	<b>WALNUT</b>	<b>LAMINATE</b>	<b>BLACK PAINTED GLASS</b>	<b>SOLID SURFACE</b>
45x30" Top	LTPL-4530	14" Base	\$1666	1830	1830	1938	2017	3091	3152
		18" Base	\$1674	1837	1837	1947	2027	3099	3162
		22" Base	\$1680	1848	1848	1955	2036	3107	3170

To specify:  
Please refer to pages 4-5 for complete specifying information.  
Specify all products by their product code.

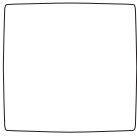

**18" Soft Square,  
Powder Coat Base**

	MODEL	TOP FINISH	TEXTURED PAINT	MAPLE	ASH	WALNUT	LAMINATE	BLACK PAINTED GLASS	SOLID SURFACE
18x18" Top	LTSS-1818	14" Base	\$1055	1156	1156	1214	1271	1429	1458
		18" Base	\$1061	1167	1167	1224	1282	1439	1469
		22" Base	\$1071	1177	1177	1234	1294	1450	1478
		28" Base	\$1081	1187	1187	1246	1306	1465	1491

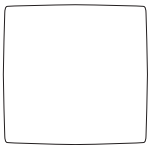

**24" Soft Square,  
Powder Coat Base**

	MODEL	TOP FINISH	TEXTURED PAINT	MAPLE	ASH	WALNUT	LAMINATE	BLACK PAINTED GLASS	SOLID SURFACE
24x24" Top	LLTSS-2424	14" Base	\$1251	1373	1373	1446	1464	1908	1946
		18" Base	\$1259	1382	1382	1457	1472	1916	1954
		22" Base	\$1266	1391	1391	1467	1482	1926	1964

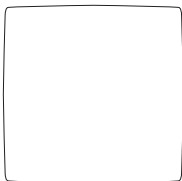

**30" Soft Square,  
Powder Coat Base**

	MODEL	TOP FINISH	TEXTURED PAINT	MAPLE	ASH	WALNUT	LAMINATE	BLACK PAINTED GLASS	SOLID SURFACE
30x30" Top	LTSS-3030	14" Base	\$1404	1543	1543	1634	1693	2473	2524
		18" Base	\$1414	1552	1552	1643	1704	2483	2532
		22" Base	\$1422	1562	1562	1652	1711	2492	2542

To specify:  
Please refer to pages 4-5 for complete specifying information.  
Specify all products by their product code.

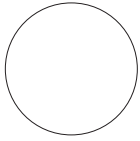

**18" Round,**

**Powder Coat Base**

	MODEL	TOP FINISH	TEXTURED PAINT	MAPLE	ASH	WALNUT	LAMINATE	BLACK PAINTED GLASS	SOLID SURFACE
18" Round Top	LTRD-18D	14" Base	\$1055	1156	1156	1214	1271	1429	1458
		18" Base	\$1061	1167	1167	1224	1282	1439	1469
		22" Base	\$1071	1177	1177	1234	1294	1450	1478
		28" Base	\$1088	1198	1198	1255	1313	1471	1501

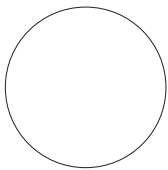

**24" Round,**

**Powder Coat Base**

	MODEL	TOP FINISH	TEXTURED PAINT	MAPLE	ASH	WALNUT	LAMINATE	BLACK PAINTED GLASS	SOLID SURFACE
24" Round Top	LTRD-24D	14" Base	\$1251	1373	1373	1446	1464	1908	1946
		18" Base	\$1259	1382	1382	1457	1472	1916	1954
		22" Base	\$1266	1391	1391	1467	1482	1926	1964
		28" Base	\$1284	1412	1412	1489	1505	1947	1987

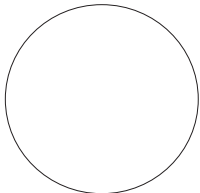

**30" Round,**

**Powder Coat Base**

	MODEL	TOP FINISH	TEXTURED PAINT	MAPLE	ASH	WALNUT	LAMINATE	BLACK PAINTED GLASS	SOLID SURFACE
30" Round Top	LTRD-30D	14" Base	\$1404	1543	1543	1634	1693	2473	2524
		18" Base	\$1414	1552	1552	1643	1704	2483	2532
		22" Base	\$1422	1562	1562	1652	1711	2492	2542

To specify:

Please refer to pages 4-5 for complete specifying information.

Specify all products by their product code.

---

**5695 Eagle Drive, SE  
Grand Rapids,  
Michigan 49512  
616-975-9260  
lelandfurniture.com**

# M2 Seating

## February 2022 Price List

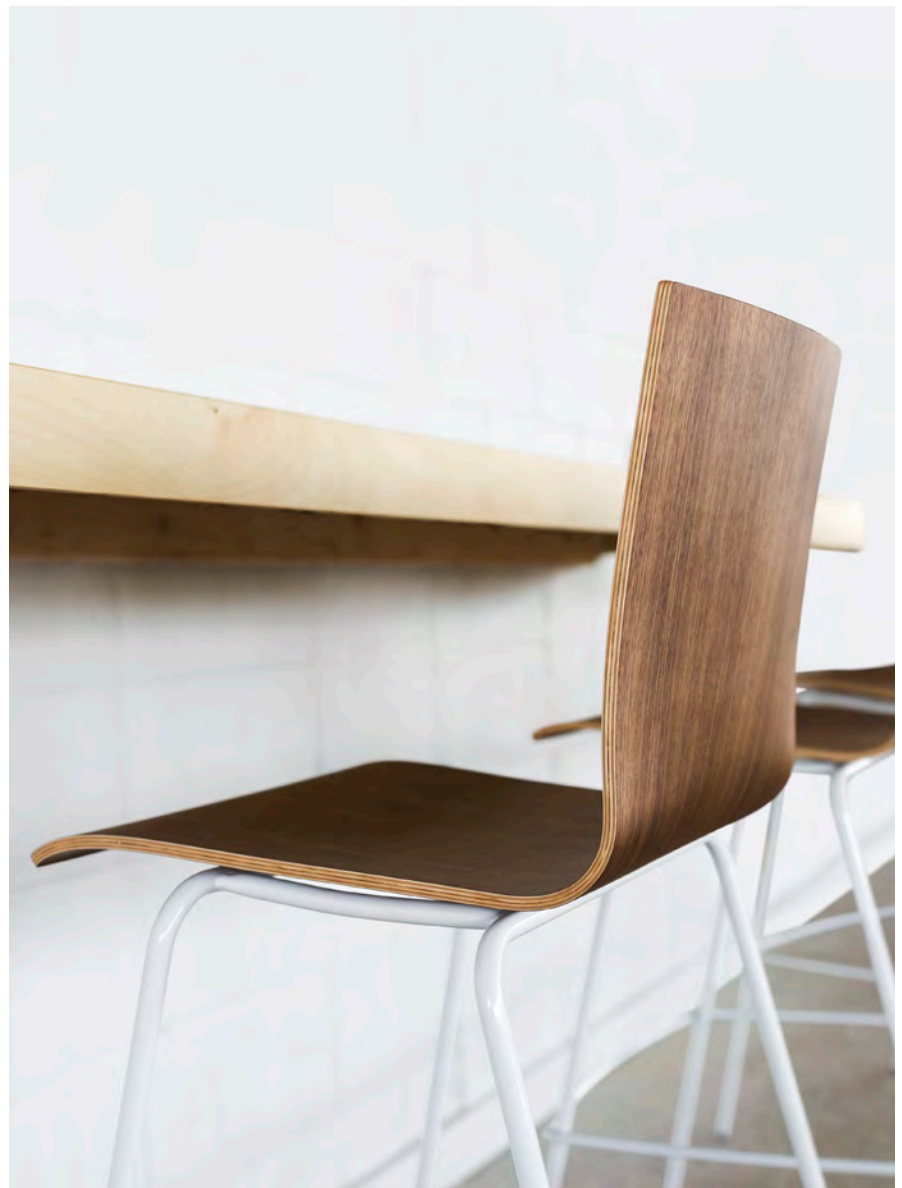



# M2 Seating

Table of Contents	M2S2
Specification Information	M2S3
Specification Example	M2S4
Side Chair	M2S5
Stacking Side Chair	M2S6
Counter Chair	M2S7
Stacking Counter Chair	M2S8
Bar Chair	M2S9
Stacking Bar Chair	M2S10
Transport/Stacking Dolly	M2S11





## Chair Model

DESCRIPTION	CODE
M2 side chair	M2S
M2 side chair, upholstered seat	M2SU
M2 stacking side chair	M2SS
M2 stacking side chair, upholstered seat	M2SSU
M2 counter chair	M2C
M2 counter chair, upholstered seat	M2CU
M2 stacking counter chair	M2CS
M2 stacking counter chair, upholstered seat	M2CSU
M2 bar chair	M2B
M2 bar chair, upholstered seat	M2BU
M2 stacking bar chair	M2BS
M2 stacking bar chair, upholstered seat	M2BSU

## Shell Veneer

DESCRIPTION	CODE
Standard	S
Walnut	W

## Shell Cut Out

DESCRIPTION	CODE	DESCRIPTION	CODE
 Plain	1	 Square	7
 Circle	2	 Soft Square	9
 Rectangle	8		

## Shell Finish

### STANDARD SHELL:

### STANDARD LELAND COLORS

### CUSTOM SPECIFY Custom (01)

\*Please note that M2 Standard Shell is NOT AVAILABLE in the following finishes:  
 Natural Walnut Matte (08M), Natural Beech (09), Natural White Oak Matte (12M)

### WALNUT SHELL:

DESCRIPTION	CODE
Natural Walnut	08

### TWO-TONE SHELL:

DESCRIPTION	CODE
Black/Natural	BKC
White/Natural	WHC

Please note that the product is only available in the Natural Finishes listed above.

## Frame Finish: Powder Coat and Chrome

DESCRIPTION	CODE
Sterling	ST
Warm Grey	WG
Cool Grey	CG
Black	B
White	W
Matte Gold Rush	MGR
Matte Mercury	MMR
Matte Mineral	MMN
Matte Burnish	MBN
Matte Foundry	MFN
<b>TEXTURED C</b>	<b>ODE</b>
Soda Red Textured	SRT
Dolphin Textured	DLT
Oxford Textured	OXT
Tangerine Textured	TNT
Ice Blue Textured	IBT
Artic Textured	ART
Caribbean Textured	CBT
Limelight Textured	LLT
Ink Textured	INT

## Upholstered Onlay Selection

Please refer to Leland Textile Program which features textiles and leathers from the following partners:

- Camira
- Green Hides
- Carnegie
- Maharam
- CF Stinson
- Unika Vaev

The complete grade list can be found on our website or you can specify COM/COL. Due to the design of this product, it is recommended that all non pre-approved textile be tested for compatibility.

## Glide Type

### STANDARD:

DESCRIPTION	CODE
Nylon	S

### OPTIONAL:

Please note that optional glides raise the chair height .5 inch.

DESCRIPTION	CODE
Felt	FC
Floor Saver™ (for VCT type floors)	FS
Metal	M
Rubber	R

## Specifications required to create the product code

- Model
- Shell Veneer
- Cut Out
- Shell Finish
- Frame Finish
- Upholstery Selection (when applicable)
- Glide Type



### MODEL

M2 Side Chair (M2S)

### SHELL VENEER

Standard (S)

### CUT OUT

Rectangle (8)

### SHELL FINISH

Red/Natural (RDC)

### FRAME FINISH

Chrome (C)

### UPHOLSTERY SELECTION

When applicable, enter upholstery grade, COM or COL



M2 SIDE CHAIR  
Design: Leland Design Group

# M2S5



M2 Side Chair	MODEL	FRAME FINISH	LIST PRICE
Standard shell  W 22 D 21.5 H 32.25 SH 17.5	M2S-S	Powder Coat	\$554
		Chrome	\$600

Optional Glides: Add \$8.00 net per chair for a set of four (4). Optional Glides raise chair height .5 inch.



M2 Side Chair	MODEL	LIST PRICE/GRADE	COM/COL	A	B	C	D	E	F	G	H	I	J	K	L
Standard Shell Upholstered seat  W 22 D 21.5 H 32.25 SH 18.5	M2SU-S	Powder Coat	\$630	674	696	719	741	764	786	809	831	854	877	899	923
		Chrome	\$675	719	741	764	786	809	831	854	877	899	923	944	968

Optional Glides: Add \$8.00 net per chair for a set of four (4). Optional Glides raise chair height .5 inch.

COM Yardage: 1 to 4 Seats: 1.5 yards

Contact Leland Customer Experience for yardage requirements on textiles with repeats.

For COL requirements please contact Leland Customer Experience..



M2 Side Chair	MODEL	FRAME FINISH	LIST PRICE
Walnut shell  W 22 D 21.5 H 32.25 SH 18.5	M2S-W	Powder Coat	\$630
		Chrome	\$675

Optional Glides: Add \$8.00 net per chair for a set of four (4). Optional Glides raise chair height .5 inch.



M2 Side Chair	MODEL	LIST PRICE/GRADE	COM/COL	A	B	C	D	E	F	G	H	I	J	K	L
Walnut Shell, Upholstered seat  W 22 D 21.5 H 32.25 SH 18.5	M2SU-W	Powder Coat	\$706	750	772	795	817	840	863	885	908	930	953	975	998
		Chrome	\$752	796	819	841	864	886	909	931	954	976	999	1023	1045

Optional Glides: Add \$8.00 net per chair for a set of four (4). Optional Glides raise chair height .5 inch.

COM Yardage: 1 to 4 Seats: 1.5 yards

Contact Leland Customer Experience for yardage requirements on textiles with repeats.

For COL requirements please contact Leland Customer Experience.

**To specify:**

**Please refer to pages 3-5 for complete specifying information.**

**Specify all products by their product code.**

M2 STACKING SIDE CHAIR  
Design: Leland Design Group

# M2S6



M2 Stacking Side Chair	MODEL	FRAME FINISH	LIST PRICE
Standard shell  W 22 D 21.5 H 32.25 SH 17.5	M2SS-S	Powder Coat	\$583
		Chrome	\$630

Optional Glides: Add \$8.00 net per chair for a set of four (4). Optional Glides raise chair height .5 inch.



M2 Stacking Side Chair	MODEL	LIST PRICE/GRADE	COM/COL	A	B	C	D	E	F	G	H	I	J	K	L
Standard Shell Upholstered seat  W 22 D 21.5 H 32.25 SH 18.5	M2SSU-S	Powder Coat	\$661	705	727	750	772	795	817	840	863	885	908	930	953
		Chrome	\$706	750	772	795	817	840	863	885	908	930	953	975	998

Optional Glides: Add \$8.00 net per chair for a set of four (4). Optional Glides raise chair height .5 inch.  
COM Yardage: 1 to 4 Seats: 1.5 yards  
Contact Leland Customer Experience for yardage requirements on textiles with repeats.  
For COL requirements please contact Leland Customer Experience.



M2 Stacking Side Chair	MODEL	FRAME FINISH	LIST PRICE
Walnut shell  W 22 D 21.5 H 32.25 SH 18.5	M2SS-W	Powder Coat	\$661
		Chrome	\$706

Optional Glides: Add \$8.00 net per chair for a set of four (4). Optional Glides raise chair height .5 inch.



M2 Stacking Side Chair	MODEL	LIST PRICE/GRADE	COM/COL	A	B	C	D	E	F	G	H	I	J	K	L
Walnut Shell, Upholstered seat  W 22 D 21.5 H 32.25 SH 18.5	M2SSU-W	Powder Coat	\$736	780	802	825	848	870	893	915	938	960	983	1005	1028
		Chrome	\$783	827	850	872	895	917	940	962	985	1008	1030	1053	1075

Optional Glides: Add \$8.00 net per chair for a set of four (4). Optional Glides raise chair height .5 inch.  
COM Yardage: 1 to 4 Seats: 1.5 yards  
Contact Leland Customer Experience for yardage requirements on textiles with repeats.  
For COL requirements please contact Leland Customer Experience.

**To specify:**  
Please refer to pages 3-5 for complete specifying information.  
Specify all products by their product code.

M2 COUNTER CHAIR  
Design: Leland Design Group

# M2S7

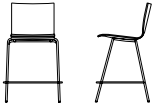

M2 Counter Chair	MODEL	FRAME FINISH	LIST PRICE
Standard shell	M2C-S	Powder Coat	\$822
W 21.5 D 21 H 37 SH 24.5		Chrome	\$870

Optional Glides: Add \$8.00 net per chair for a set of four (4). Optional Glides raise chair height .5 inch.



M2 Counter Chair	MODEL	LIST PRICE/GRADE	COM/COL	A	B	C	D	E	F	G	H	I	J	K	L
Standard Shell	M2CU-S	Powder Coat	\$901	944	968	990	1013	1035	1058	1081	1103	1126	1148	1171	1193
Upholstered seat		Chrome	\$948	992	1015	1038	1060	1083	1105	1128	1150	1173	1195	1218	1241

W 21.5 D 21 H 37 SH 25.5

Optional Glides: Add \$8.00 net per chair for a set of four (4). Optional Glides raise chair height .5 inch.  
COM Yardage: 1 to 4 Seats: 1.5 yards  
Contact Leland Customer Experience for yardage requirements on textiles with repeats.  
For COL requirements please contact Leland Customer Experience.



M2 Counter Chair	MODEL	FRAME FINISH	LIST PRICE
Walnut shell	M2C-W	Powder Coat	\$901
W 21.5 D 21 H 37 SH 24.5		Chrome	\$948

Optional Glides: Add \$8.00 net per chair for a set of four (4). Optional Glides raise chair height .5 inch.



M2 Counter Chair	MODEL	LIST PRICE/GRADE	COM/COL	A	B	C	D	E	F	G	H	I	J	K	L
Walnut Shell,	M2CU-W	Powder Coat	\$981	1025	1047	1070	1092	1115	1137	1160	1183	1205	1228	1250	1273
Upholstered seat		Chrome	\$1028	1072	1094	1117	1140	1162	1185	1207	1230	1252	1275	1297	1321

W 21.5 D 21 H 37 SH 25.5

Optional Glides: Add \$8.00 net per chair for a set of four (4). Optional Glides raise chair height .5 inch.  
COM Yardage: 1 to 4 Seats: 1.5 yards  
Contact Leland Customer Experience for yardage requirements on textiles with repeats.  
For COL requirements please contact Leland Customer Experience.

**To specify:**  
Please refer to pages 3-5 for complete specifying information.  
Specify all products by their product code.

M2 STACKING COUNTER CHAIR  
Design: Leland Design Group

# M2S8

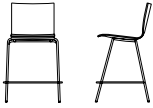

M2 Stacking Counter Chair	MODEL	FRAME FINISH	LIST PRICE
Standard shell	M2CS-S	Powder Coat	\$854
W 21.5 D 21 H 37 SH 24.5		Chrome	\$902

Optional Glides: Add \$8.00 net per chair for a set of four (4). Optional Glides raise chair height .5 inch.



M2 Stacking Counter Chair	MODEL	LIST PRICE/ GRADE	COM/COL	A	B	C	D	E	F	G	H	I	J	K	L
Standard Shell	M2CSU-S	Powder Coat	\$936	980	1002	1025	1047	1070	1092	1115	1137	1160	1183	1205	1228
Upholstered seat		Chrome	\$981	1025	1047	1070	1092	1115	1137	1160	1183	1205	1228	1250	1273

W 21.5 D 21 H 37 SH 25.5

Optional Glides: Add \$8.00 net per chair for a set of four (4). Optional Glides raise chair height .5 inch.

COM Yardage: 1 to 4 Seats: 1.5 yards

Contact Leland Customer Experience for yardage requirements on textiles with repeats.

For COL requirements please contact Leland Customer Experience.



M2 Stacking Counter Chair	MODEL	FRAME FINISH	LIST PRICE
Walnut shell	M2CS-W	Powder Coat	\$936
W 21.5 D 21 H 37 SH 24.5		Chrome	\$981

Optional Glides: Add \$8.00 net per chair for a set of four (4). Optional Glides raise chair height .5 inch.



M2 Stacking Counter Chair	MODEL	LIST PRICE/ GRADE	COM/COL	A	B	C	D	E	F	G	H	I	J	K	L
Walnut Shell,	M2CSU-W	Powder Coat	\$1015	1059	1082	1104	1127	1149	1172	1194	1217	1239	1262	1285	1307
Upholstered seat		Chrome	\$1062	1106	1129	1151	1174	1196	1219	1242	1264	1288	1310	1333	1355

W 21.5 D 21 H 37 SH 25.5

Optional Glides: Add \$8.00 net per chair for a set of four (4). Optional Glides raise chair height .5 inch.

COM Yardage: 1 to 4 Seats: 1.5 yards

Contact Leland Customer Experience for yardage requirements on textiles with repeats.

For COL requirements please contact Leland Customer Experience.

**To specify:**

**Please refer to pages 3-5 for complete specifying information. Specify all products by their product code.**

M2 BAR CHAIR  
Design: Martin Ballendat

# M2S9



M2 Bar Chair	MODEL	FRAME FINISH	LIST PRICE
Standard shell	M2B-S	Powder Coat	\$837
W 21.5 D 22 H 41.5 SH 29.5		Chrome	\$885

Optional Glides: Add \$8.00 net per chair for a set of four (4).



M2 Bar Chair	MODEL	LIST PRICE/GRADE	COM/COL	A	B	C	D	E	F	G	H	I	J	K	L
Standard shell, upholstered seat onlay	M2BU-S	Powder Coat	\$916	960	983	1005	1028	1050	1073	1096	1118	1141	1163	1186	1208
		Chrome	\$966	1010	1032	1056	1078	1101	1123	1146	1169	1191	1214	1236	1259

W 21.5 D 22 H 41.5 SH 30.5

Optional Glides: Add \$8.00 net per chair for a set of four (4). Optional Glides raise chair height .5 inch.  
COM Yardage: 1 to 4 Seats: 1.5 yards  
Contact Leland Customer Experience for yardage requirements on textiles with repeats.  
For COL requirements please contact Leland Customer Experience.



M2 Bar Chair	MODEL	FRAME FINISH	LIST PRICE
Walnut shell	M2B-W	Powder Coat	\$916
W 21.5 D 22 H 41.5 SH 29.5		Chrome	\$966

Optional Glides: Add \$8.00 net per chair for a set of four (4). Optional Glides raise chair height .5 inch.



M2 Bar Chair	MODEL	LIST PRICE/GRADE	COM/ COL	A	B	C	D	E	F	G	H	I	J	K	L
Walnut shell, upholstered seat onlay	M2BU-W	Powder Coat	\$998	1042	1064	1087	1111	1133	1156	1178	1201	1223	1246	1268	1291
		Chrome	\$1046	1090	1113	1135	1158	1180	1203	1225	1248	1271	1293	1316	1338

W 21.5 D 22 H 41.5 SH 30.5

Optional Glides: Add \$8.00 net per chair for a set of four (4). Optional Glides raise chair height .5 inch.  
COM Yardage: 1 to 4 Seats: 1.5 yards  
Contact Leland Customer Experience for yardage requirements on textiles with repeats.  
For COL requirements please contact Leland Customer Experience.

**To specify:**  
Please refer to pages 3-5 for complete specifying information.  
Specify all products by their product code.



M2 STACKING BAR CHAIR  
Design: Martin Ballendat

# M2S10



M2 Stacking Bar Chair	MODEL	FRAME FINISH	LIST PRICE
Standard shell	M2BS-S	Powder Coat	\$871
W 21.5 D 22 H 41.5 SH 29.5		Chrome	\$917

Optional Glides: Add \$8.00 net per chair for a set of four (4).



M2 Stacking Bar Chair	MODEL	LIST PRICE/GRADE	COM/COL	A	B	C	D	E	F	G	H	I	J	K	L
Standard shell, upholstered seat onlay	M2BSU-S	Powder Coat	\$951	995	1017	1040	1062	1085	1107	1130	1152	1175	1198	1220	1244
		Chrome	\$999	1043	1067	1089	1112	1134	1157	1179	1202	1224	1247	1269	1292

W 21.5 D 22 H 41.5 SH 30.5

Optional Glides: Add \$8.00 net per chair for a set of four (4). Optional Glides raise chair height .5 inch.  
COM Yardage: 1 to 4 Seats: 1.5 yards  
Contact Leland Customer Experience for yardage requirements on textiles with repeats.  
For COL requirements please contact Leland Customer Experience.



M2 Stacking Bar Chair	MODEL	FRAME FINISH	LIST PRICE
Walnut shell	M2BS-W	Powder Coat	\$951
W 21.5 D 22 H 41.5 SH 29.5		Chrome	\$999

Optional Glides: Add \$8.00 net per chair for a set of four (4). Optional Glides raise chair height .5 inch.



M2 Stacking Bar Chair	MODEL	LIST PRICE/GRADE	COM/COL	A	B	C	D	E	F	G	H	I	J	K	L
Walnut shell, upholstered seat onlay	M2BSU-W	Powder Coat	\$1031	1075	1098	1120	1144	1165	1189	1211	1234	1257	1279	1302	1324
		Chrome	\$1079	1123	1146	1169	1191	1214	1236	1259	1281	1304	1326	1349	1371

W 21.5 D 22 H 41.5 SH 30.5

Optional Glides: Add \$8.00 net per chair for a set of four (4). Optional Glides raise chair height .5 inch.  
COM Yardage: 1 to 4 Seats: 1.5 yards  
Contact Leland Customer Experience for yardage requirements on textiles with repeats.  
For COL requirements please contact Leland Customer Experience.

**To specify:**  
Please refer to pages 3-5 for complete specifying information.  
Specify all products by their product code.



**M2 Chair Transport/  
Stacking Dolly**

	MODEL	FRAME FINISH	LIST PRICE
W 23 D 33 H 6 (empty)	M2D	Powder Coat	\$1160

To specify:  
Please refer to pages 3-5 for  
complete specifying information.  
Specify all products by their  
product code.

---

**5695 Eagle Drive, SE**  
**Grand Rapids,**  
**Michigan 49512**  
**616-975-9260**  
**[lelandfurniture.com](http://lelandfurniture.com)**

# M3 Table

## February 2022 Price List



# M3 Table

Table of Contents	M3T2
Soft Square Pedestal Table Base Visual Reference	M3T4
Soft Square Counter & Bar Base Visual Reference	M3T5
Circle Pedestal Table Base Visual Reference	M3T6
Circle Counter & Bar Table Base Visual Reference	M3T7
Specification Information	M38
Specification Example	M3T10
Small Soft Square Base	M3T11
Medium Soft Square Base	M3T12
Large Soft Square Base	M3T13
Extra Large Soft Square Base	M3T14
Small Soft Square Counter Base	M3T15
Large Soft Square CounterBase	M3T16
Small Soft Square Bar Base	M3T17
Large Soft Square Bar Base	M3T18
Extra Small Circle Base	M3T19
Small Circle Base	M3T20
Medium Circle Base	M3T21
Large Circle Base	M3T22
Extra Large Circle Base	M3T23
Extra-Extra Large Circle Base	M3T24
Extra Small Circle Counter Base	M3T25
Small Circle Counter Base	M3T26
Medium Circle Counter Base	M3T27

# M3 Table

---

Extra Small Circle Bar Base	M3T28
Small Circle Bar Base	M3T29
Large Circle Bar Base	M3T30

---













TABLE MODEL	TABLE TOP SIZES			BASE	COLUMN/BASE	PAGE
Small Soft Square Pedestal Table Base	 24 DIA 30 DIA	 24 x 24 30 x 30	 24 x 30	18" Soft Square	Powder Coat/Powder Coat	Page M3T11
						
Medium Soft Square Pedestal Table Base	 36 DIA	 36 x 36		20" Soft Square	Powder Coat/Powder Coat	Page M3T12
						
Large Soft Square Pedestal Table Base	 42 DIA	 42 x 42		22" Soft Square	Powder Coat/Powder Coat	Page M3T13
						
Extra Large Soft Square Pedestal Table Base	 48 DIA	 48 x 48		24" Soft Square	Powder Coat/Powder Coat	Page M3T14
						











TABLE MODEL	TABLE TOP SIZES			BASE	COLUMN/BASE	PAGE
Small Soft Square Counter Table Base	 24 DIA 30 DIA	 24 x 24 30 x 30	 24 x 30	18" Soft Square	Powder Coat/Powder Coat	Page M3T15
Large Soft Square Counter Table Base	 36 DIA	 36 x 36		24" Soft Square	Powder Coat/Powder Coat	Page M3T16
Small Soft Square Bar Table Base	 24 DIA 30 DIA	 24 x 24 30 x 30	 24 x 30	18" Soft Square	Powder Coat/Powder Coat	Page M3T17
Large Soft Square Bar Table Base	 36 DIA	 36 x 36		24" Soft Square	Powder Coat/Powder Coat	Page M3T18





















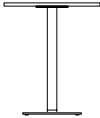



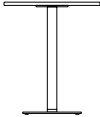

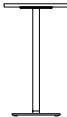

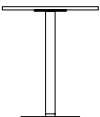



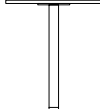

TABLE MODEL	TABLE TOP SIZES		BASE	COLUMN/BASE	PAGE
Extra Small Circle Pedestal Table Base 	Round   24 DIA	Square   24 x 24	18"-Diameter	Powder Coat/Powder Coat	Page M3T19
Small Circle Pedestal Table Base 	Round   30 DIA	Rectangle   24 x 30	20"-Diameter	Powder Coat/Powder Coat	Page M3T20
Medium Circle Pedestal Table Base 	Round   36 DIA	Square   30 x 30	22"-Diameter	Powder Coat/Powder Coat	Page M3T21
Large Circle Pedestal Table Base 	Round   42 DIA	Square   36 x 36	26"-Diameter	Powder Coat/Powder Coat	Page M3T22
Extra Large Circle Pedestal Table Base 	Round   48 DIA	Square   42 x 42	28"-Diameter	Powder Coat/Powder Coat	Page M3T23
Extra-Extra Large Circle Pedestal Table Base 		Square   48 x 48	30"-Diameter	Powder Coat/Powder Coat	Page M3T24

TABLE MODEL	TABLE TOP SIZES			BASE	COLUMN/BASE	PAGE
Extra Small Circle Counter Table Base 	Round  24 DIA			18"-Diameter	Powder Coat/Powder Coat	Page M3T25
Small Circle Counter Table Base 	Round  30 DIA	Square  24 x 24	Rectangle  24 x 30	20"-Diameter	Powder Coat/Powder Coat	Page M3T26
Medium Circle Counter Table Base 	Round  36 DIA	Square  30 x 30		22"-Diameter	Powder Coat/Powder Coat	Page M3T27
Extra Small Circle Bar Table Base 	Round  24 DIA			18"-Diameter	Powder Coat/Powder Coat	Page M3T28
Small Circle Bar Table Base 	Round  30 DIA	Square  24 x 24	Rectangle  24 x 30	20"-Diameter	Powder Coat/Powder Coat	Page M3T29
Medium Circle Bar Table Base 	Round  36 DIA	Square  30 x 30		22"-Diameter	Powder Coat/Powder Coat	Page M3T30

## Table Model

DESCRIPTION	CODE
M3 pedestal table, small soft square base	M3SB
M3 pedestal table, medium soft square base	M3MB
M3 pedestal table, large soft square base	M3LB
M3 pedestal table, extra large soft square base	M3XLB
M3 pedestal table, small counter soft square base	M3SCB
M3 pedestal table, large counter soft square base	M3LCB
M3 pedestal table, small bar soft square base	M3SBB
M3 pedestal table, large bar soft square base	M3LBB
M3 pedestal table, extra small circle base	M3CXSB
M3 pedestal table, small circle base	M3CSB
M3 pedestal table, medium circle base	M3CMB
M3 pedestal table, large circle base	M3CLB
M3 pedestal table, extra large circle base	M3CXLB
M3 pedestal table, extra-extra large circle base	M3CXLB
M3 pedestal table, extra small counter circle base	M3CXSCB
M3 pedestal table, small bar circle base	M3CSCB
M3 pedestal table, medium bar circle base	M3CMCB
M3 pedestal table, extra small bar circle base	M3CXSB
M3 pedestal table, small bar circle base	M3CSBB
M3 pedestal table, medium bar circle base	M3CMBB

## Base Finish: Powder Coat

DESCRIPTION	CODE
Black Textured	BT
White Textured	WT
Grey Textured	GT
Sterling	ST
Matte Gold Rush	MGR
Matte Mercury	MMR
Matte Mineral	MMN
Matte Burnish	MBN
Matte Foundry	MFN

## Top Sizes

ROUND	CODE	SQUARE	CODE	RECTANGLE	CODE
24 DIA	24D	24x24	2424	24x30	2430
30 DIA	30D	30x30	3030		
36 DIA	36D	36x36	3636		
42 DIA	42D	2x42	4242		
48 DIA	48D	48x48	4848		

## Top Finish or Color

### WOOD TOPS:

### STANDARD LELAND COLORS

**CUSTOM SPECIFY** custom (01)

\*Please note that M3 Tables are NOT AVAILABLE in the following finishes:  
Natural Walnut Matte (08M), Natural Beech (09), Natural White Oak Matte (12M)

### LAMINATE TOPS:

DESCRIPTION	CODE
Grey Laminate Slate Grey Wilsonart®	LGY
Black Laminate Black Pionite®	LBK
White Laminate Designer White Wilsonart®	LWH

Please refer to the Leland Terms and Conditions Guide for a listing of standard laminates.  
For table pricing in laminates not listed, please contact Leland's Customer Experience Department for a quotation.

### FORBO

DESCRIPTION	CODE
Pearl	4157
Mauve	4172
Pebble	4175
Smokey Blue	4179
Olive	4184

Edge finish options: natural (11) plywood (W2)

## Edge Type

---

### VINYL EDGES:

DESCRIPTION	CODE
1 3/16" flat PVC	V2



3/4" flat PVC	V5
---------------	----

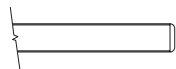

### WOOD EDGES:

DESCRIPTION	CODE
1" beveled plywood	W6

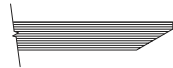

1" flat plywood	W2
-----------------	----



## Edge Finish or Color

---

### VINYL EDGE COLORS:

DESCRIPTION	CODE
Black	B
White	W
Grey	G

### WOOD EDGE COLORS:

#### STANDARD LELAND COLORS

**CUSTOM SPECIFY** Custom (01)

\*Please note that M3 Tables are NOT AVAILABLE in the following finishes:  
Natural Walnut Matte (08M), Natural Beech (09), Natural White Oak Matte (12M)

For laminate tops, edge can be specified in any standard Leland finish. Wood tops and edges must be specified in the same standard Leland finish.

**Specifications required to create the product code**

- Model
- Base Column Finish
- Base Plate Finish
- Top Size
- Top Finish Or Color
- Edge Type
- Edge Finish Or Color



**MODEL**

M3 Pedestal Table,  
Medium Circle Base (M3CMB)

**BASE CENTER**

White (W)

**TOP SIZE**

42" Diameter (42D)

**TOP COLOR OR FINISH**

White Laminate (LWH)

**EDGE TYPE**

1" Flat Plywood (W2)

**EDGE FINISH OR COLOR**

Natural Maple (11)





M3 PEDESTAL TABLE, SMALL SOFT SQUARE BASE  
 Design: Leland Design Group

M3T11



**M3 Pedestal Table,  
 Powder Coat Base**

	MODEL	TOP SIZE/CODE	LIST PRICE/EDGE CODES:	V2	V5	W6	W2
Small soft square	M3SB-P-P	Wood Top					
		24 DIA - 24D		\$1366	1327	1687	1687
H 29		30 DIA - 30D		\$1782	1744	2283	2283
		24x24 - 2424		\$1366	1327	1687	1687
Round	Square	30x30 - 3030		\$1782	1744	2283	2283
		24x30 - 2430		\$1546	1507	1974	1974
24 DIA	24 x 24	Laminate Top					
30 DIA	30 x 30	24 DIA - 24D		\$1219	1181	1485	1485
		30 DIA - 30D		\$1573	1535	1993	1993
		24x24 - 2424		\$1219	1181	1484	1484
		30x30 - 3030		\$1573	1535	1993	1993
		24x30 - 2430		\$1647	1609	2006	2006
		Forbo Top					
		24 DIA - 24D				\$1769	1769
		30 DIA - 30D				\$2123	2123
		24x24 - 2424				\$1769	1769
		30x30 - 3030				\$2123	2123
		24x30 - 2430				\$2197	2197

To specify:  
 Please refer to pages 6-8 for complete specifying information.  
 Specify all products by their product code.

M3 PEDESTAL TABLE, MEDIUM SOFT SQUARE BASE  
 Design: Leland Design Group

# M3T12

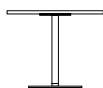

**M3 Pedestal Table,  
 Powder Coat Base**

	MODEL	TOP SIZE/CODE	LIST PRICE/EDGE CODES:	V2	V5	W6	W2
Medium soft square	M3MB-P-P	Wood Top					
		36 DIA - 36D		\$1880	1842	2380	2380
H 29		36x36 - 3636		\$1880	1842	2380	2380
		Laminate Top					
Round		36 DIA - 36D		\$1656	1617	2076	2076
36 DIA		36x36 - 3636		\$1656	1617	2076	2076
Square		Forbo Top					
		36 DIA - 36D				\$2206	2206
		36x36 - 3636				\$2206	2206

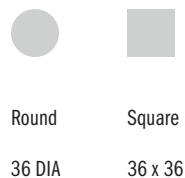



To specify:  
 Please refer to pages 6-8 for complete specifying information.  
 Specify all products by their product code.

M3 PEDESTAL TABLE, LARGE SOFT SQUARE BASE  
 Design: Leland Design Group

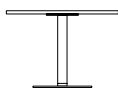
# M3T13



**M3 Pedestal Table,  
 Powder Coat Base**

	MODEL	TOP SIZE/CODE	LIST PRICE/EDGE CODES:	V2	W6	W2
Large soft square	M3LB-P-P	Wood Top				
		42 DIA - 42D		\$2575	3075	3075
H 29		42x42 - 4242		\$2575	3075	3075
		Laminate Top				
Round	Square	42 DIA - 42D		\$2247	2666	2666
42 DIA	42 x 42	42x42 - 4242		\$2247	2666	2666
		Forbo Top				
		42 DIA - 42D			\$3072	3072
		42x42 - 4242			\$3072	3072

To specify:  
 Please refer to pages 6-8 for complete specifying information.  
 Specify all products by their product code.



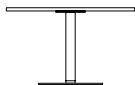

M3 PEDESTAL TABLE, EXTRA LARGE SOFT SQUARE BASE  
 Design: Leland Design Group

# M3T14



**M3 Pedestal Table,  
 Powder Coat Base**

	MODEL	TOP SIZE/CODE	LIST PRICE/EDGE CODES:	V2	W6	W2
Extra Large soft square	M3XLB-P-P	Wood Top				
		48 DIA - 48D		\$2680	3130	3075
H 29		48x48 - 4848		\$2630	3130	3075
 		Laminate Top				
Round		48 DIA - 48D		\$2291	2710	2710
48 DIA		48x48 - 4848		\$2291	2710	2710
Square		Forbo Top				
		48 DIA - 48D			\$3535	3535
		48x48 - 4848			\$3535	3535



To specify:  
 Please refer to pages 6-8 for complete specifying information.  
 Specify all products by their product code.

M3 PEDESTAL TABLE, SMALL SOFT SQUARE COUNTER BASE  
 Design: Leland Design Group

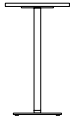
# M3T15



**M3 Pedestal Table,  
 Powder Coat Base**

	MODEL	TOP SIZE/CODE	LIST PRICE/EDGE CODES:	V2	V5	W6	W2
Small soft square counter	M3SCB-P-P	Wood Top					
		24 DIA - 24D		\$1428	1390	1749	1749
H 36		30 DIA - 30D		\$1845	1807	2345	2345
		24x24 - 2424		\$1428	1390	1749	1749
		30x30 - 3030		\$1845	1807	2345	2345
Round	Square	24x30 - 2430		\$1614	1570	2036	2036
24 DIA	24 x 24						
30 DIA	30 x 30						
		Rectangle					
		24 x 30					
		Laminate Top					
		24 DIA - 24D		\$1288	1249	1554	1554
		30 DIA - 30D		\$1642	1603	2062	2062
		24x24 - 2424		\$1288	1249	1554	1554
		30x30 - 3030		\$1642	1603	2062	2062
		24x30 - 2430		\$1715	1671	2074	2074
		Forbo Top					
		24 DIA - 24D				\$1870	1870
		30 DIA - 30D				\$2224	2224
		24x24 - 2424				\$1870	1870
		30x30 - 3030				\$2224	2224
		24x30 - 2430				\$2308	2308

To specify:  
 Please refer to pages 6-8 for complete specifying information.  
 Specify all products by their product code.

M3 PEDESTAL TABLE, LARGE SOFT SQUARE COUNTER BASE  
 Design: Leland Design Group

# M3T16

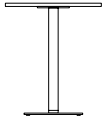

**M3 Pedestal Table,  
 Powder Coat Base**

	MODEL	TOP SIZE/CODE	LIST PRICE/EDGE CODES:	V2	V5	W6	W2
Large soft square counter	M3LCB-P-P	Wood Top					
		36 DIA - 36D		\$1937	1904	2443	2443
H 36		36x36 - 3636		\$1937	1904	2443	2443
		Laminate Top					
Round		36 DIA - 36D		\$1724	1686	2144	2144
36 DIA		36x36 - 3636		\$1724	1686	2144	2144
Square							
36 x 36							
		Forbo Top					
		36 DIA - 36D				\$2307	2307
		36x36 - 3636				\$2307	2307



Round      Square  
 36 DIA    36 x 36

To specify:  
 Please refer to pages 6-8 for complete specifying information.  
 Specify all products by their product code.



Pricing Effective: February 2022

M3 PEDESTAL TABLE, SMALL SOFT SQUARE BAR BASE  
 Design: Leland Design Group

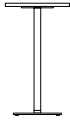
# M3T17



**M3 Pedestal Table,  
 Powder Coat Base**

	MODEL	TOP SIZE/CODE	LIST PRICE/EDGE CODES:	V2	V5	W6	W2
Small soft square bar	M3SBB-P-P	Wood Top					
		24 DIA - 24D		\$1489	1450	1810	1810
H 42		30 DIA - 30D		\$1905	1867	2406	2406
		24x24 - 2424		\$1489	1450	1810	1810
Round	Square	30x30 - 3030		\$1905	1867	2406	2406
		24x30 - 2430		\$1669	1631	2097	2097
24 DIA	24 x 24	Laminate Top					
30 DIA	30 x 30	24 DIA - 24D		\$1343	1304	1609	1609
		30 DIA - 30D		\$1697	1658	2117	2117
		24x24 - 2424		\$1343	1304	1609	1609
		30x30 - 3030		\$1697	1658	2117	2117
		24x30 - 2430		\$1770	1732	2129	2129
		Forbo Top					
		24 DIA - 24D				\$1892	1892
		30 DIA - 30D				\$2246	2246
		24x24 - 2424				\$1892	1892
		30x30 - 3030				\$2246	2246
		24x30 - 2430				\$2330	2330

To specify:  
 Please refer to pages 6-8 for complete specifying information.  
 Specify all products by their product code.

M3 PEDESTAL TABLE, LARGE SOFT SQUARE BAR BASE  
 Design: Leland Design Group

# M3T18

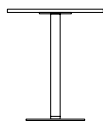

**M3 Pedestal Table,  
 Powder Coat Base**

	MODEL	TOP SIZE/CODE	LIST PRICE/EDGE CODES:	V2	V5	W6	W2
Large soft square bar	M3LBB-P-P	Wood Top					
		36 DIA - 36D		\$2003	1965	2504	2504
H 42		36x36 - 3636		\$2003	1965	2504	2504
		Laminate Top					
Round	Square	36 DIA - 36D		\$1779	1741	2199	2199
36 DIA	36 x 36	36x36 - 3636		\$1779	1741	2199	2199
		Forbo Top					
		36 DIA - 36D				\$2329	2329
		36x36 - 3636				\$2329	2329

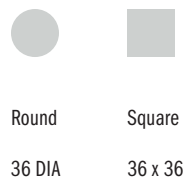

To specify:  
 Please refer to pages 6-8 for complete specifying information.  
 Specify all products by their product code.

M3 PEDESTAL TABLE, EXTRA SMALL CIRCLE BASE  
 Design: Leland Design Group

# M3T19



**M3 Pedestal Table,  
 Powder Coat Base**

	MODEL	TOP SIZE/CODE	LIST PRICE/EDGE CODES:	V2	V5	W6	W2
Extra small circle	M3CXSB-P-P	Wood Top					
		24 DIA - 24D		\$1366	1327	1687	1687
H 29		24x24 - 2424		\$1366	1327	1687	1687
		Laminate Top					
Round	Square	24 DIA - 24D		\$1219	1181	1485	1485
24 DIA	24 x 24	24x24 - 2424		\$1219	1181	1485	1485
		Forbo Top					
		24 DIA - 24D				\$1769	1769
		24x24 - 2424				\$1769	1769



Round

Square

24 DIA

24 x 24

To specify:

Please refer to pages 6-8 for complete specifying information.

Specify all products by their product code.

Pricing Effective: February 2022

M3 PEDESTAL TABLE, SMALL CIRCLE BASE  
 Design: Leland Design Group

# M3T20



**M3 Pedestal Table,  
 Powder Coat Base**

	MODEL	TOP SIZE/CODE	LIST PRICE/EDGE CODES:	V2	V5	W6	W2
Small circle	M3CSB-P-P	Wood Top					
		30 DIA - 30D		\$1782	1744	2283	2283
H 29		24x30 - 2430		\$1546	1507	1974	1974
		Laminate Top					
Round		30 DIA - 30D		\$1573	1535	1993	1993
30 DIA		24x30 - 2430		\$1647	1609	2006	2006
		Forbo Top					
		30 DIA - 30D				\$2123	2123
		24x30 - 2430				\$2197	2197



Round      Rectangle

30 DIA      24 x 30

**To specify:**  
 Please refer to pages 6-8 for complete specifying information.  
 Specify all products by their product code.



**Pricing Effective: February 2022**

M3 PEDESTAL TABLE, MEDIUM CIRCLE BASE  
 Design: Leland Design Group

# M3T21



**M3 Pedestal Table,  
 Powder Coat Base**

	MODEL	TOP SIZE/CODE	LIST PRICE/EDGE CODES:	V2	V5	W6	W2
Medium circle	M3CMB-P-P	Wood Top					
		36 DIA - 36D		\$1880	1842	2380	2380
H 29		30x30 - 3030		\$1782	1744	2283	2283
		Laminate Top					
Round	Square	36 DIA - 36D		\$1656	1617	2076	2076
36 DIA	30 x 30	30x30 - 3030		\$1573	1535	1993	1993
		Forbo Top					
		36 DIA - 36D				\$2206	2206
		30x30 - 3030				\$2123	2123

To specify:  
 Please refer to pages 6-8 for complete specifying information.  
 Specify all products by their product code.





M3 PEDESTAL TABLE, LARGE CIRCLE BASE  
 Design: Leland Design Group

# M3T22



**M3 Pedestal Table,  
 Powder Coat Base**

	MODEL	TOP SIZE/CODE	LIST PRICE/EDGE CODES:	V2	V5	W6	W2
Large circle	M3CLB-P-P	Wood Top					
		42 DIA - 42D		\$2575	2537	3075	3075
H 29		36x36 - 3636		\$1880	1842	2380	2380
		Laminate Top					
Round	Square	42 DIA - 42D		\$2247	2209	2666	2666
42 DIA	36 x 36	36x36 - 3636		\$1656	1617	2076	2076
		Forbo Top					
		42 DIA - 42D				\$3072	3072
		36x36 - 3636				\$2206	2206



To specify:  
 Please refer to pages 6-8 for complete specifying information.  
 Specify all products by their product code.

M3 PEDESTAL TABLE, EXTRA LARGE CIRCLE BASE  
 Design: Leland Design Group

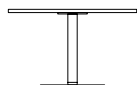
# M3T23



**M3 Pedestal Table,  
 Powder Coat Base**

	MODEL	TOP SIZE/CODE	LIST PRICE/EDGE CODES:	V2	V5	W6	W2
Extra large circle	M3CXLB-P-P	Wood Top					
		48 DIA - 48D		\$2680	2641	3130	3075
H 29		42x42 - 4242		\$2575	2537	3075	3075
 		Laminate Top					
Round	Square	48 DIA - 48D		\$2291	2253	2710	2710
48 DIA	42 x 42	42x42 - 4242		\$2247	2209	2666	2666
		Forbo Top					
		48 DIA - 48D				\$3116	3116
		42x42 - 4242				\$3072	3072

To specify:  
 Please refer to pages 6-8 for complete specifying information.  
 Specify all products by their product code.

M3 PEDESTAL TABLE, EXTRA-EXTRA LARGE CIRCLE BASE  
 Design: Leland Design Group

# M3T24

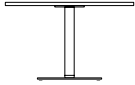

**M3 Pedestal Table,  
 Powder Coat Base**

	MODEL	TOP SIZE/CODE	LIST PRICE/EDGE CODES:	V2	V5	W6	W2
Extra-extra large circle	M3CXXLB-P-P	Wood Top					
		48x48 - 4848		\$2630	2592	3130	3075
H 29		Laminate Top					
		48x48 - 4848		\$2291	2253	2710	2710
Square		Forbo Top					
		48x48 - 4848				\$3116	3116

To specify:  
 Please refer to pages 6-8 for complete specifying information.  
 Specify all products by their product code.

Pricing Effective: February 2022

M3 PEDESTAL TABLE, EXTRA SMALL CIRCLE  
COUNTER BASE

Design: Leland Design Group

# M3T25

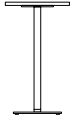

**M3 Pedestal Table,  
Powder Coat Base**

	MODEL	TOP SIZE/CODE	LIST PRICE/EDGE CODES:	V2	V5	W6	W2
Extra small circle counter	M3CXSCB-P-P	Wood Top					
		24 DIA - 24D		\$1428	1390	1749	1749
H 36		Laminate Top					
		24 DIA - 24D		\$1288	1249	1554	1554
Circle		Forbo Top					
		24 DIA - 24D				\$1870	1870



Circle

24 DIA



To specify:  
Please refer to pages 6-8 for complete specifying information.  
Specify all products by their product code.

M3 PEDESTAL TABLE, SMALL CIRCLE COUNTER BASE  
 Design: Leland Design Group

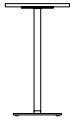
# M3T26



**M3 Pedestal Table,  
 Powder Coat Base**

	MODEL	TOP SIZE/CODE	LIST PRICE/EDGE CODES:	V2	V5	W6	W2
Small circle counter	M3CSCB-P-P	Wood Top					
		30 DIA - 30D		\$1845	1807	2345	2345
H 36		24x24 - 2424		\$1428	1390	1749	1749
		24x30 - 2430		\$1614	1570	2036	2036
  		Laminate Top					
Round		30 DIA - 30D		\$1642	1603	2062	2062
Square		24x24 - 2424		\$1288	1249	1554	1554
Rectangle		24x30 - 2430		\$1715	1671	2074	2074
30 DIA		Forbo Top					
		30 DIA - 30D				\$2224	2224
		24x24 - 2424				\$1870	1870
		24x30 - 2430				\$2308	2308

To specify:  
 Please refer to pages 6-8 for complete specifying information.  
 Specify all products by their product code.

M3 PEDESTAL TABLE, MEDIUM CIRCLE COUNTER BASE  
 Design: Leland Design Group

# M3T27

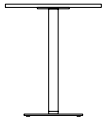

**M3 Pedestal Table,  
 Powder Coat Base**

	MODEL	TOP SIZE/CODE	LIST PRICE/EDGE CODES:	V2	V5	W6	W2
Medium circle counter	M3CMCB-P-P	Wood Top					
		30X30 - 3030		\$1845	1807	2345	2345
H 36		Laminate Top					
		30X30 - 3030		\$1642	1603	2062	2062
Square		Forbo Top					
30 x 30		30X30 - 3030				\$2224	2224

To specify:  
 Please refer to pages 6-8 for complete specifying information.  
 Specify all products by their product code.

M3 PEDESTAL TABLE, EXTRA SMALL CIRCLE BAR BASE  
 Design: Leland Design Group

# M3T28



**M3 Pedestal Table,  
 Powder Coat Base**

	MODEL	TOP SIZE/CODE	LIST PRICE/EDGE CODES:	V2	V5	W6	W2
Extra small circle bar	M3CXSBP-P-P	Wood Top					
		24 DIA - 24D		\$1489	1450	1810	1810
H 42		Laminate Top					
		24 DIA - 24D		\$1343	1304	1609	1609
Circle		Forbo Top					
24 DIA		24 DIA - 24D				\$1892	1892



To specify:  
 Please refer to pages 6-8 for complete specifying information.  
 Specify all products by their product code.

M3 PEDESTAL TABLE, SMALL CIRCLE BAR BASE  
 Design: Leland Design Group

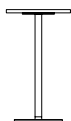
# M3T29



**M3 Pedestal Table,  
 Powder Coat Base**

	MODEL	TOP SIZE/CODE	LIST PRICE/EDGE CODES:	V2	V5	W6	W2
Small circle bar	M3CSBB-P-P	Wood Top					
		30 DIA - 30D		\$1905	1867	2406	2406
H 42		24x24 - 2424		\$1489	1450	1810	1810
		24x30 - 2430		\$1669	1631	2097	2097
  		Laminate Top					
Round		30 DIA - 30D		\$1697	1658	2117	2117
Square		24x24 - 2424		\$1343	1304	1609	1609
Rectangle		24x30 - 2430		\$1770	1732	2129	2129
30 DIA		Forbo Top					
		30 DIA - 30D				\$2246	2246
		24x24 - 2424				\$1892	1892
		24x30 - 2430				\$2330	2330

To specify:  
 Please refer to pages 6-8 for complete specifying information.  
 Specify all products by their product code.



M3 PEDESTAL TABLE, MEDIUM CIRCLE BAR BASE  
 Design: Leland Design Group

# M3T30

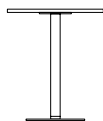

**M3 Pedestal Table,  
 Powder Coat Base**

	MODEL	TOP SIZE/CODE	LIST PRICE/EDGE CODES:	V2	V5	W6	W2
Medium circle bar	M3CMBB-P-P	Wood Top					
		30X30 - 3030		\$1905	1867	2406	2406
H 42		Laminate Top					
		30X30 - 3030		\$1697	1658	2117	2117
Square		Forbo Top					
30 x 30		30X30 - 3030				\$2246	2246

To specify:  
 Please refer to pages 6-8 for complete specifying information.  
 Specify all products by their product code.

---

**5695 Eagle Drive, SE**  
**Grand Rapids,**  
**Michigan 49512**  
**616-975-9260**  
**[lelandfurniture.com](http://lelandfurniture.com)**

---

**5695 Eagle Drive, SE**  
**Grand Rapids,**  
**Michigan 49512**  
**616-975-9260**  
**[lelandfurniture.com](http://lelandfurniture.com)**

# Marquette Seating

## February 2022 Price List



# Marquette Seating

Table of Contents	MQ2
Specification Information	MQ3
Specification Example	MQ4
Stacking Side Chair, Sled Base	MQ5
Counter Chair, Sled Base	MQ6
Bar Chair, Sled Base	MQ7
Little Marquette Side Chair	MQ8
Marquette Transport/Stacking Dolly	MQ9

**Chair Model**

**SLED BASE:**

DESCRIPTION	CODE
Marquette side chair	MQS
Marquette side chair, upholstered seat	MQSU
Marquette counter chair	MQC
Marquette counter chair, upholstered seat	MQCU
Marquette bar chair	MQB
Marquette bar chair, upholstered seat	MQBU
Little Marquette chair	MQL

**Shell Finish**

**STANDARD LELAND COLORS**

**CUSTOM SPECIFY** Custom (01)

\*Please note that Marquette Chair is NOT AVAILABLE in the following finishes:  
 Natural Walnut Matte (08M), Natural Beech (09), Natural White Oak Matte (12M)















**Shell Style**

SHELL	CODE	SHELL	CODE
Linear	L	Arc	A





**Back Cut Out**

LINEAR CUT OUTS	CODE	ARC CUT OUTS	CODE
Plain back	1	Plain back	1
Circle 	2	Circle 	2
Diamond 	4	Diamond 	4
Grid 	5	Grid 	5
Perforated 	3	Slotted 	6
Dots 	10	Dots 	10
Squares 	11	Reeds 	13
Reeds 	13	Mosaic 	15
Custom cut out	00	Custom cut out	00

**Frame Finish**

DESCRIPTION	CODE
Black	B
Chrome	C
Sterling	ST

TEXTURED	CODE
Soda Red Textured	SRT
Dolphin Textured	DLT
Oxford Textured	OXT
Tangerine Textured	TNT
Ice Blue Textured	IBT
Artic Textured	ART
Caribbean Textured	CBT
Limelight Textured	LLT
Ink Textured	INT

**Upholstery Selection**

Please refer to Leland Textile Program which features textiles and leathers from the following partners:

- Camira
- Carnegie
- CF Stinson
- Green Hides
- Maharam
- Unika Vaev

The complete grade list can be found on our website or you can specify COM/COL. Due to the design of this product, it is recommended that all non pre-approved textile be tested for compatibility.

**Glide Type**

STANDARD:	DESCRIPTION	CODE
	Poly	S

OPTIONAL:	DESCRIPTION	CODE
	Felt	FC

Specifications required to create the product code

- Model
- Shell Style
- Back Cut Out
- Shell Finish
- Frame Finish
- Upholstery selection (when applicable)
- Glide Type



MODEL

Marquette Side Chair, Upholstered Seat, Sled Base (MQSU)

SHELL STYLE

Linear (L)

BACK CUT OUT

Grid (5)

SHELL FINISH

Natural (11)

FRAME FINISH

Chrome (C)

UPHOLSTERY

When applicable: Upholstery— Enter Leland textile code or COM/COL

ARM CAP FINISH

When applicable, enter Leland Color code



MARQUETTE STACKING SIDE CHAIR, SLED BASE  
Design: Leland Design Group

MQ5

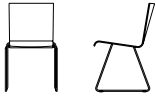

Marquette Side Chair	MODEL	FRAME FINISH	LIST PRICE
Sled base, linear shell	MQS-L	Powder Coat	\$455
W 19.75 D 21 H 34 SH 18.5		Chrome	\$507

Optional Glides: Add \$8.00 net per chair for a set of four (4).

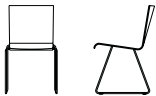

Marquette Side Chair	MODEL	LIST PRICE/GRADE	COM/COL	A	B	C	D	E	F	G	H	I	J	K	L
Sled base, linear shell upholstered seat onlay	MQSU-L	Powder Coat	\$542	566	578	590	603	615	626	638	650	662	674	685	697
		Chrome	\$595	620	632	644	655	667	680	692	704	715	727	739	751

W 19.75 D 21 H 34 SH 18.75

COM Yardage: 1-2 seats: .75 yard; 3-4 seats: 1.25 yards; 5-6 seats: 1.75 yards  
Contact Leland Customer Service for yardage requirements on textiles with repeats.  
For COL requirements please contact Leland Customer Experience.



Marquette Side Chair	MODEL	FRAME FINISH	LIST PRICE
Sled base, arc shell	MQS-A	Powder Coat	\$455
W 19.75 D 21 H 34 SH 18.5		Chrome	\$507

Optional Glides: Add \$8.00 net per chair for a set of four (4).



Marquette Side Chair	MODEL	LIST PRICE/GRADE	COM/COL	A	B	C	D	E	F	G	H	I	J	K	L
Sled base, arc shell upholstered seat onlay	MQSU-A	Powder Coat	\$542	566	578	590	603	615	626	638	650	662	674	685	697
		Chrome	\$595	620	632	644	655	667	680	692	704	715	727	739	751

W 19.75 D 21 H 34 SH 18.75

COM Yardage: 1-2 seats: .75 yard; 3-4 seats: 1.25 yards; 5-6 seats: 1.75 yards  
Contact Leland Customer Service for yardage requirements on textiles with repeats.  
For COL requirements please contact Leland Customer Experience.

To specify:  
Please refer to pages 3-5 for complete specifying information.  
Specify all products by their product code.



MARQUETTE COUNTER CHAIR, SLED BASE  
Design: Leland Design Group

MQ6

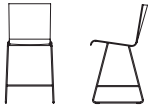

Marquette Counter Chair	MODEL	FRAME FINISH	LIST PRICE
Sled base, linear shell  W 19.25 D 22.5 H 39.75 SH 25.25	MQC-L	Powder Coat	\$750
		Chrome	\$821

Optional Glides: Add \$8.00 net per chair for a set of four (4). Optional Glides raise chair height .5 inch.

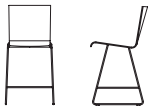

Marquette Counter Chair	MODEL	LIST PRICE/GRADE	COM/COL	A	B	C	D	E	F	G	H	I	J	K	L
Sled base, linear shell upholstered seat onlay  W 19.25 D 22.5 H 39.75 SH 25.5	MQCU-L	Powder Coat	\$844	870	882	894	906	917	929	941	953	965	976	988	1001
		Chrome	\$915	940	952	964	975	987	999	1012	1024	1035	1047	1059	1071

COM Yardage: 1-2 seats: .75 yard; 3-4 seats: 1.25 yards; 5-6 seats: 1.75 yards  
Contact Leland Customer Service for yardage requirements on textiles with repeats.  
For COL requirements please contact Leland Customer Experience.

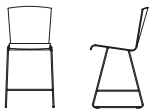

Marquette Counter Chair	MODEL	FRAME FINISH	LIST PRICE
Sled base, arc shell  W 19.25 D 22.5 H 39.75 SH 25.25	MQC-A	Powder Coat	\$750
		Chrome	\$821

Optional Glides: Add \$8.00 net per chair for a set of four (4). Optional Glides raise chair height .5 inch.



Marquette Counter Chair	MODEL	LIST PRICE/GRADE	COM/COL	A	B	C	D	E	F	G	H	I	J	K	L
Sled base, arc shell upholstered seat onlay  W 19.25 D 22.5 H 39.75 SH 25.5	MQCU-A	Powder Coat	\$844	870	882	894	906	917	929	941	953	965	976	988	1001
		Chrome	\$915	940	952	964	975	987	999	1012	1024	1035	1047	1059	1071

COM Yardage: 1-2 seats: .75 yard; 3-4 seats: 1.25 yards; 5-6 seats: 1.75 yards  
Contact Leland Customer Service for yardage requirements on textiles with repeats.  
For COL requirements please contact Leland Customer Experience.

**To specify:**  
Please refer to pages 3-5 for complete specifying information.  
Specify all products by their product code.

**MARQUETTE BAR CHAIR, SLED BASE**  
Design: Leland Design Group

**MQ7**

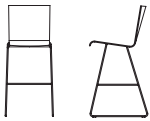

Marquette Bar Chair	MODEL	FRAME FINISH	LIST PRICE
sled base, linear shell	MQB-L	Powder Coat	\$765
W 19.5 D 23 H 44 SH 30.25		Chrome	\$851

Optional Glides: Add \$8.00 net per chair for a set of four (4). Optional Glides raise chair height .5 inch.

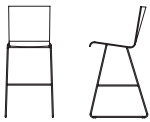

Marquette Bar Chair	MODEL	LIST PRICE/GRADE	COM/COL	A	B	C	D	E	F	G	H	I	J	K	L
Sled base, linear shell upholstered seat onlay	MQBU-L	Powder Coat	\$859	884	896	908	919	931	943	955	968	980	991	1003	1015
		Chrome	\$947	972	984	996	1008	1019	1031	1043	1056	1068	1079	1091	1103

W 19.5 D 23 H 44 SH 30.5

COM Yardage: 1-2 seats: .75 yard; 3-4 seats: 1.25 yards; 5-6 seats: 1.75 yards  
Contact Leland Customer Service for yardage requirements on textiles with repeats.  
For COL requirements please contact Leland Customer Experience.

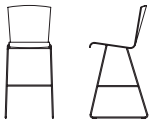

Marquette Bar Chair	MODEL	FRAME FINISH	LIST PRICE
Sled base, arc shell	MQB-A	Powder Coat	\$765
W 19.5 D 23 H 44 SH 30.25		Chrome	\$851

Optional Glides: Add \$8.00 net per chair for a set of four (4). Optional Glides raise chair height .5 inch.



Marquette Bar Chair	MODEL	LIST PRICE/ GRADE	COM/COL	A	B	C	D	E	F	G	H	I	J	K	L
Sled base, arc shell upholstered seat onlay	MQBU-A	Powder Coat	\$859	884	896	908	919	931	943	955	968	980	991	1003	1015
		Chrome	\$947	972	984	996	1008	1019	1031	1043	1056	1068	1079	1091	1103

W 19.5 D 23 H 44 SH 30.5

COM Yardage: 1-2 seats: .75 yard; 3-4 seats: 1.25 yards; 5-6 seats: 1.75 yards  
Contact Leland Customer Service for yardage requirements on textiles with repeats.  
For COL requirements please contact Leland Customer Experience.

**To specify:**  
Please refer to pages 3-5 for complete specifying information.  
Specify all products by their product code.

LITTLE MARQUETTE SIDE CHAIR  
Design: Leland Design Group

MQ8



**Little Marquette  
Side Chair**

	MODEL	FRAME FINISH	LIST PRICE
Sled base, arc shell	MQL-A	Powder Coat	\$520
W 16 D 19 H 28 SH 15		Chrome	\$554

Optional Glides: Add \$8.00 net per chair for a set of four (4).  
Powder Coat: Black or Sterling only.



**Little Marquette  
Side Chair**

	MODEL	FRAME FINISH	LIST PRICE
Sled base, crescent shell	MQL-C	Powder Coat	\$520
W 16 D 19 H 28 SH 15		Chrome	\$554

Optional Glides: Add \$8.00 net per chair for a set of four (4).  
Powder Coat: Black or Sterling only.

**BACK CUT OUTS AVAILABLE FOR THE LITTLE MARQUETTE:**

SWAMP THINGS SERIES	CODE	GEOMETRIC SERIES	CODE	PETROGLYPH SERIES	CODE	CELESTIAL SERIES	CODE
Lizard	1S	Shapes	1G	Deer	1P	Saturn	1C
Tree Frog	2S	Circle	2G	Antelope	2P	Shooting Star	2C
Turtle	3S	Square	3G	Ram	3P	Starry Night	3C
Snake	4S	Triangle	4G	Horse	4P	Moon	4C

To specify:  
Please refer to pages 3-5 for complete specifying information.  
Specify all products by their product code.

Pricing Effective: February 2022

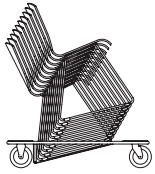

**Marquette Transport/  
Stacking Dolly**

	MODEL	FRAME FINISH	LIST PRICE
W 23 D 33 H 6 (empty)	MQD	Powder Coat	\$991
W 23 D 33 H 38 (with 10 side chairs)		Marquette Transport/Stacking Dolly handles up to 10 Marquette side chairs	

**PROPER STACKING OF MARQUETTE SLED BASE CHAIRS  
(10 CHAIRS MAXIMUM)**

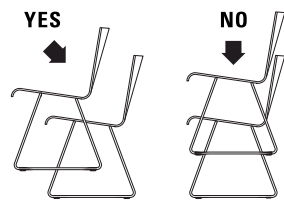

To specify:  
 Please refer to pages 3-5 for complete specifying information.  
 Specify all products by their product code.

---

**5695 Eagle Drive, SE**  
**Grand Rapids,**  
**Michigan 49512**  
**616-975-9260**  
**[lelandfurniture.com](http://lelandfurniture.com)**

# Mass

## February 2022 Price List



# Mass

Table of Contents	MA2
Specification Information	MA3
Specification Example	MA4
Stacking Side Chair	MA5
Stacking Side Chair, Upholstered Seat	MA6
Stacking Arm Chair	MA7
Stacking Arm Chair, Upholstered Seat	MA8
Stacking Counter Chair	MA9
Stacking Counter Chair, Upholstered Seat	MA10
Stacking Bar Chair	MA11
Stacking Bar Chair, Upholstered Seat	MA12
Transport/Stacking Dolly	MA13
Ganging Device	MA13

**Chair Model**

DESCRIPTION	CODE
Mass stacking side chair	Mass
Mass stacking side chair, upholstered seat	MassU
Mass stacking arm chair	MASA
Mass stacking arm chair, upholstered seat	MASAU
Mass stacking counter chair	MASC
Mass stacking counter chair, upholstered seat	MASCU
Mass stacking bar chair	MASB
Mass stacking bar chair, upholstered seat	MASBU
Mass transport/stacking dolly	MASD

**Seat/Back Color**

**POLYPROPYLENE SHELL:**

DESCRIPTION	CODE
White	WT
Recycled Black	RB
Grey	G
Pistachio	PS

**CUSTOM POLYPROPYLENE COLORS**

Custom color match is available upon request. Please contact hello@lelandfurniture.com for further information

**Onlay Selection**

Please refer to Leland Textile Program which features textiles and leathers from the following partners:

- Camira
- Carnegie
- CF Stinson
- Green Hides
- Maharam
- Unika Vaev

The complete grade list can be found at [www.lelandfurniture.com/resources](http://www.lelandfurniture.com/resources) or you can specify COM/COL. Due to the design of this product, it is recommended that all non pre-approved textile be tested for compatibility.

**Frame Finish**

DESCRIPTION	CODE
Chrome	C
Sterling	ST
White Textured	WT
Black Textured	BT
Grey Textured	GT
Black	B
White	W

**Glide Type**

**STANDARD GLIDE:**

DESCRIPTION	CODE
Felt	F

**Stacking Note**

Mass side chair, arm chair and bar chair models stack as follows (includes upholstered):

**SIDE CHAIR:**

Floor: 15 High  
Dolly: 40 High

**ARM CHAIR:**

Floor: 12 High  
Dolly: 40 High

**BAR & COUNTER CHAIR:**

Floor: 8 High

**Chair Weight**

**SIDE CHAIR:** 12 lbs

**ARM CHAIR:** 14 lbs



**Specifications required to create the product code**

- Model
- Shell Finish
- Upholstered Onlay Selection (when applicable)
- Frame Finish
- Glide or Caster Type

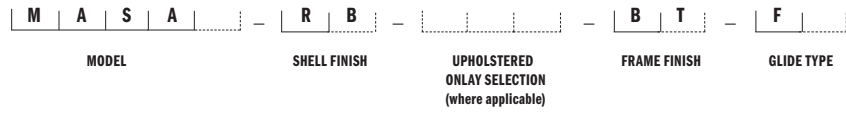

**MODEL**

Mass stacking arm chair (MASA)

**SHELL FINISH**

Recycled Black (RB)

**UPHOLSTERED ONLAY SELECTION**

When applicable, enter upholstery grade, COM



**FRAME FINISH**

Black Textured (BT)

**GLIDE TYPE**

Standard Felt (F)



**MASS STACKING SIDE CHAIR**  
 Design: ITEMdesignworks, licensed by Sellex

**MA5**



**PRICING FOR QUANTITIES 1-99**

<b>Mass Stacking Side Chair</b>	<b>MODEL</b>	<b>FRAME FINISH</b>	<b>LIST PRICE</b>
Polypropylene shell	MASS	Powder Coat	\$347
W 20.5 D 20.5 H 32.25 SH 18.75		Chrome	\$407



**PRICING FOR QUANTITIES 100-299**

<b>Mass Stacking Side Chair</b>	<b>MODEL</b>	<b>FRAME FINISH</b>	<b>LIST PRICE</b>
Polypropylene shell	MASS	Powder Coat	\$331
W 20.5 D 20.5 H 32.25 SH 18.75		Chrome	\$384



**PRICING FOR QUANTITIES 300+**

<b>Mass Stacking Side Chair</b>	<b>MODEL</b>	<b>FRAME FINISH</b>	<b>LIST PRICE</b>
Polypropylene shell	MASS	Powder Coat	\$310
W 20.5 D 20.5 H 32.25 SH 18.75		Chrome	\$363

**To specify:**  
 Please refer to pages 3-4 for complete specifying information.  
 Specify all products by their product code.

**Pricing Effective: February 2022**

MASS STACKING SIDE CHAIR, UPHOLSTERED SEAT  
 Design: ITEMdesignworks, licensed by Sellex

MA6



PRICING FOR QUANTITIES 1-99

Mass Stacking Side Chair	MODEL	LIST PRICE/GRADE	COM/COL	A	B	C	D	E	F	G	H	I	J	K	L
Polypropylene shell, upholstered seat onlay	MASSU	Powder Coat	\$478	511	544	578	611	644	677	710	743	776	809	842	875
		Chrome	\$538	571	604	637	670	703	737	770	803	836	869	902	935

W 20.5 D 20.5 H 32.25 SH 18.75

COM Yardage: 1-3 seats: .5 yard  
 Contact Leland Customer Experience for yardage requirements on textiles with repeats.  
 For COL requirements please contact Leland Customer Experience.



PRICING FOR QUANTITIES 100-299

Mass Stacking Side Chair	MODEL	LIST PRICE/GRADE	COM/COL	A	B	C	D	E	F	G	H	I	J	K	L
Polypropylene shell, upholstered seat onlay	MASSU	Powder Coat	\$450	484	517	550	583	616	649	682	715	748	781	815	848
		Chrome	\$507	540	573	606	639	673	706	739	772	805	838	871	904

W 20.5 D 20.5 H 32.25 SH 18.75

COM Yardage: 1-3 seats: .5 yard  
 Contact Leland Customer Experience for yardage requirements on textiles with repeats.  
 For COL requirements please contact Leland Customer Experience.



PRICING FOR QUANTITIES 300+

Mass Stacking Side Chair	MODEL	LIST PRICE/GRADE	COM/COL	A	B	C	D	E	F	G	H	I	J	K	L
Polypropylene shell, upholstered seat onlay	MASSU	Powder Coat	\$426	459	492	525	558	591	624	658	691	724	757	790	823
		Chrome	\$479	512	545	579	612	645	678	711	744	777	810	843	876

W 20.5 D 20.5 H 32.25 SH 18.75

COM Yardage: 1-3 seats: .5 yard  
 Contact Leland Customer Experience for yardage requirements on textiles with repeats.  
 For COL requirements please contact Leland Customer Experience.

To specify:  
 Please refer to pages 3-4 for  
 complete specifying information.  
 Specify all products by their  
 product code.

Pricing Effective: February 2022

**MASS STACKING ARM CHAIR**  
 Design: ITEMdesignworks, licensed by Sellex

**MA7**



**PRICING FOR QUANTITIES 1-99**

<b>Mass Stacking Arm Chair</b>	<b>MODEL</b>	<b>FRAME FINISH</b>	<b>LIST PRICE</b>
Polypropylene shell	MASA	Powder Coat	\$480
W 20.5 D 20.5 H 32.25 SH 18.75		Chrome	\$539



**PRICING FOR QUANTITIES 100-299**

<b>Mass Stacking Arm Chair</b>	<b>MODEL</b>	<b>FRAME FINISH</b>	<b>LIST PRICE</b>
Polypropylene shell	MASA	Powder Coat	\$450
W 20.5 D 20.5 H 32.25 SH 18.75		Chrome	\$511



**PRICING FOR QUANTITIES 300+**

<b>Mass Stacking Arm Chair</b>	<b>MODEL</b>	<b>FRAME FINISH</b>	<b>LIST PRICE</b>
Polypropylene shell	MASA	Powder Coat	\$427
W 20.5 D 20.5 H 32.25 SH 18.75		Chrome	\$479

**To specify:**  
 Please refer to pages 3-4 for complete specifying information.  
 Specify all products by their product code.

**Pricing Effective: February 2022**

**MASS STACKING ARM CHAIR, UPHOLSTERED SEAT**  
 Design: ITEMdesignworks, licensed by Sellex

**MA8**



**PRICING FOR QUANTITIES 1-99**

**Mass Stacking Arm Chair**

MODEL	LIST PRICE/GRADE	COM/COL	A	B	C	D	E	F	G	H	I	J	K	L
MASAU	Powder Coat	\$560	594	627	660	693	726	759	792	825	858	891	924	958
	Chrome	\$622	655	689	722	755	788	821	854	887	920	953	986	1019

W 20.5 D 20.5 H 32.25 SH 18.75

COM Yardage: 1-3 seats: .5 yard  
 Contact Leland Customer Experience for yardage requirements on textiles with repeats.  
 For COL requirements please contact Leland Customer Experience.



**PRICING FOR QUANTITIES 100-299**

**Mass Stacking Arm Chair**

MODEL	LIST PRICE/GRADE	COM/COL	A	B	C	D	E	F	G	H	I	J	K	L
MASAU	Powder Coat	\$529	563	596	629	662	695	728	761	794	827	860	893	927
	Chrome	\$588	621	654	687	721	754	787	820	853	886	919	952	985

W 20.5 D 20.5 H 32.25 SH 18.75

COM Yardage: 1-3 seats: .5 yard  
 Contact Leland Customer Experience for yardage requirements on textiles with repeats.  
 For COL requirements please contact Leland Customer Experience.



**PRICING FOR QUANTITIES 300+**

**Mass Stacking Arm Chair**

MODEL	LIST PRICE/GRADE	COM/COL	A	B	C	D	E	F	G	H	I	J	K	L
MASAU	Powder Coat	\$500	533	566	599	632	665	698	731	764	797	831	864	897
	Chrome	\$554	587	620	653	686	719	753	786	819	852	885	918	951

W 20.5 D 20.5 H 32.25 SH 18.75

COM Yardage: 1-3 seats: .5 yard  
 Contact Leland Customer Experience for yardage requirements on textiles with repeats.  
 For COL requirements please contact Leland Customer Experience.

**To specify:**  
 Please refer to pages 3-4 for complete specifying information.  
 Specify all products by their product code.

**MASS STACKING COUNTER CHAIR**  
 Design: ITEMdesignworks, licensed by Sellex

**MA9**



**PRICING FOR QUANTITIES 1-99**

<b>Mass Stacking Counter Chair</b>	<b>MODEL</b>	<b>FRAME FINISH</b>	<b>LIST PRICE</b>
Polypropylene shell	MASC	Powder Coat	\$620
W 21.75 D 20.5 H 40.75 SH 25		Chrome	\$680



**PRICING FOR QUANTITIES 100-299**

<b>Mass Stacking Counter Chair</b>	<b>MODEL</b>	<b>FRAME FINISH</b>	<b>LIST PRICE</b>
Polypropylene shell	MASC	Powder Coat	\$586
W 21.75 D 20.5 H 40.75 SH 25		Chrome	\$643



**PRICING FOR QUANTITIES 300+**

<b>Mass Stacking Counter Chair</b>	<b>MODEL</b>	<b>FRAME FINISH</b>	<b>LIST PRICE</b>
Polypropylene shell	MASC	Powder Coat	\$552
W 21.75 D 20.5 H 40.75 SH 25		Chrome	\$587

**To specify:**  
 Please refer to pages 3-4 for complete specifying information.  
 Specify all products by their product code.

**Pricing Effective: February 2022**

**MASS STACKING COUNTER CHAIR, UPHOLSTERED SEAT**  
 Design: ITEMdesignworks, licensed by Sellex

**MA10**



**PRICING FOR QUANTITIES 1-99**

**Mass Stacking Counter Chair**

MODEL	LIST PRICE/GRADE	COM/COL	A	B	C	D	E	F	G	H	I	J	K	L
MASCU	Powder Coat	\$744	777	809	841	873	905	937	969	1001	1033	1065	1097	1129
	Chrome	\$805	837	869	901	933	965	997	1029	1061	1093	1125	1157	1190

W 21.75 D 20.5 H 40.75 SH 25

COM Yardage: 1-3 seats: .5 yard  
 Contact Leland Customer Experience for yardage requirements on textiles with repeats.  
 For COL requirements please contact Leland Customer Experience.

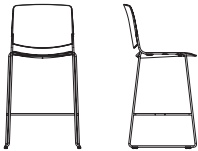

**PRICING FOR QUANTITIES 100-299**

**Mass Stacking Counter Chair**

MODEL	LIST PRICE/GRADE	COM/COL	A	B	C	D	E	F	G	H	I	J	K	L
MASCU	Powder Coat	\$702	734	766	798	831	863	895	927	959	991	1023	1055	1088
	Chrome	\$761	793	825	857	889	921	953	985	1018	1050	1082	1114	1146

W 21.75 D 20.5 H 40.75 SH 25

COM Yardage: 1-3 seats: .5 yard  
 Contact Leland Customer Experience for yardage requirements on textiles with repeats.  
 For COL requirements please contact Leland Customer Experience.

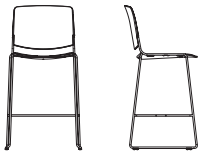

**PRICING FOR QUANTITIES 300+**

**Mass Stacking Counter Chair**

MODEL	LIST PRICE/GRADE	COM/COL	A	B	C	D	E	F	G	H	I	J	K	L
MASCU	Powder Coat	\$662	694	726	758	790	822	854	886	918	950	983	1015	1047
	Chrome	\$715	747	779	811	844	876	908	940	972	1005	1037	1069	1101

W 21.75 D 20.5 H 40.75 SH 25

COM Yardage: 1-3 seats: .5 yard  
 Contact Leland Customer Experience for yardage requirements on textiles with repeats.  
 For COL requirements please contact Leland Customer Experience.

**To specify:**  
 Please refer to pages 3-4 for complete specifying information.  
 Specify all products by their product code.

**Pricing Effective: February 2022**

**MASS STACKING BAR CHAIR**  
 Design: ITEMdesignworks, licensed by Sellex

**MA11**



**PRICING FOR QUANTITIES 1-99**

<b>Mass Stacking Bar Chair</b>	<b>MODEL</b>	<b>FRAME FINISH</b>	<b>LIST PRICE</b>
Polypropylene shell	MASB	Powder Coat	\$639
W 21.75 D 20.5 H 40.75 SH 29		Chrome	\$701



**PRICING FOR QUANTITIES 100-299**

<b>Mass Stacking Bar Chair</b>	<b>MODEL</b>	<b>FRAME FINISH</b>	<b>LIST PRICE</b>
Polypropylene shell	MASB	Powder Coat	\$604
W 21.75 D 20.5 H 40.75 SH 29		Chrome	\$663



**PRICING FOR QUANTITIES 300+**

<b>Mass Stacking Bar Chair</b>	<b>MODEL</b>	<b>FRAME FINISH</b>	<b>LIST PRICE</b>
Polypropylene shell	MASB	Powder Coat	\$569
W 21.75 D 20.5 H 40.75 SH 29		Chrome	\$605

**To specify:**  
 Please refer to pages 3-4 for complete specifying information.  
 Specify all products by their product code.

**Pricing Effective: February 2022**



**MASS STACKING BAR CHAIR, UPHOLSTERED SEAT**  
 Design: ITEMdesignworks, licensed by Sellex

**MA12**



**PRICING FOR QUANTITIES 1-99**

**Mass Stacking Bar Chair**

MODEL	LIST PRICE/GRADE	COM/COL	A	B	C	D	E	F	G	H	I	J	K	L
MASBU	Powder Coat	\$768	801	834	867	900	933	966	999	1032	1065	1098	1132	1165
	Chrome	\$829	863	896	929	962	995	1028	1061	1094	1127	1160	1193	1227

W 21.75 D 20.5 H 40.75 SH 29

COM Yardage: 1-3 seats: .5 yard  
 Contact Leland Customer Experience for yardage requirements on textiles with repeats.  
 For COL requirements please contact Leland Customer Experience.



**PRICING FOR QUANTITIES 100-299**

**Mass Stacking Bar Chair**

MODEL	LIST PRICE/GRADE	COM/COL	A	B	C	D	E	F	G	H	I	J	K	L
MASBU	Powder Coat	\$724	757	790	823	856	889	922	955	989	1022	1055	1088	1121
	Chrome	\$785	818	851	884	917	950	983	1016	1049	1082	1116	1149	1182

W 21.75 D 20.5 H 40.75 SH 29

COM Yardage: 1-3 seats: .5 yard  
 Contact Leland Customer Experience for yardage requirements on textiles with repeats.  
 For COL requirements please contact Leland Customer Experience.



**PRICING FOR QUANTITIES 300+**

**Mass Stacking Bar Chair**

MODEL	LIST PRICE/GRADE	COM/COL	A	B	C	D	E	F	G	H	I	J	K	L
MASBU	Powder Coat	\$682	715	748	781	815	848	881	914	947	980	1013	1046	1079
	Chrome	\$738	771	804	837	870	903	936	969	1002	1035	1069	1102	1135

W 21.75 D 20.5 H 40.75 SH 29

COM Yardage: 1-3 seats: .5 yard  
 Contact Leland Customer Experience for yardage requirements on textiles with repeats.  
 For COL requirements please contact Leland Customer Experience.

**To specify:**  
 Please refer to pages 3-4 for complete specifying information.  
 Specify all products by their product code.

**MASS TRANSPORT/STACKING DOLLY**  
 Design: ITEMdesignworks, licensed by Sellex

**MA13**



Mass Transport/Stacking Dolly	MODEL	FRAME FINISH	LIST PRICE
Black powder coat finish	MASD		\$958

W 34.5 D 23 H 17  
 (Dimensions of dolly when empty)

W 41.25 D 23 H 65.25  
 (Dimensions with 40 poly chair stack)

Mass Transport/Stacking Dolly capacity: 40 high (15 high on floor)  
 Weight with 40 high on dolly: 565 lbs  
 For use with Side and Arm Chair models (including upholstered)  
 \*\*Bar and Counter models do not stack on dolly

**MASS AUXILIARY OPTIONS**  
 Design: ITEMdesignworks, licensed by Sellex



Ganging Device	MODEL	LIST PRICE
two per set	GD	\$50

Available for all models \*\*Only comes in recycled black

**To specify:**  
 Please refer to pages 3-4 for complete specifying information.  
 Specify all products by their product code.

**Pricing Effective: February 2022**

---

**5695 Eagle Drive, SE  
Grand Rapids,  
Michigan 49512  
616-975-9260  
lelandfurniture.com**

# Omena

## February 2022 Price List



# Omena

Table of Contents	OM2
Specification Information	OM3
Specification Example	OM4
Side Chair	OM5
Counter Stool	OM7
Bar Stool	OM8
Low Stool	OM9

## Chair Model

DESCRIPTION	CODE
Omena side chair	OMSW
Omena side chair, upholstered seat	OMSWU
Omena side chair, upholstered seat and back	OMSWUU
Omena counter stool	OMCW
Omena counter stool, upholstered seat	OMCWU
Omena bar stool	OMBW
Omena bar stool, upholstered seat	OMBWU
Omena low stool	OMLW
Omena low stool, upholstered seat	OMLWU

## Shell Veneer

DESCRIPTION	CODE
Maple (standard)	M
Oak (premium)	O

## Shell Leg/Finish

### STANDARD SHELL/LEG (MAPLE):

### STANDARD LELAND COLORS

### CUSTOM SPECIFY Custom (01)

### OAK SHELL/BASE:

DESCRIPTION	CODE
Morel	66M
Weathered	68M
Dune	69M
Trillium	70M

### GRADIENT FINISHES

DESCRIPTION	CODE
Blue Sky Gradient BG	90MG
Forest Gradient FG	86MG
Gravel Gradient GG	87MG
Dawn Gradient DG	88MG
Heather Gradient HG	99MG

Gradient Finishes applied on maple shell/leg only and are only offered on Omena side chair and low stool.

## Upholstery Selection

Please refer to Leland Textile Program which features textiles and leathers from the following partners:

- Camira
- Green Hides
- Carnegie
- Maharam
- CF Stinson
- Unika Vaev

The complete grade list can be found on our website or you can specify COM/COL. Due to the design of this product, it is recommended that all non pre-approved textile be tested for compatibility.

## Glide Type

### STANDARD:

DESCRIPTION	CODE
Nylon	S

### OPTIONAL:

Please note that optional glides raise the chair height .5 inch.

DESCRIPTION	CODE
Rubber	R
Felt	FC

## Stacking note

The Omena chair/stool does not stack.

Specifications required to create the product code

- Model
- Wood Species
- Shell Finish
- Seat Upholstery Selection (when applicable)
- Leg Finish
- Back Upholstery Selection (when applicable)
- Glide Type

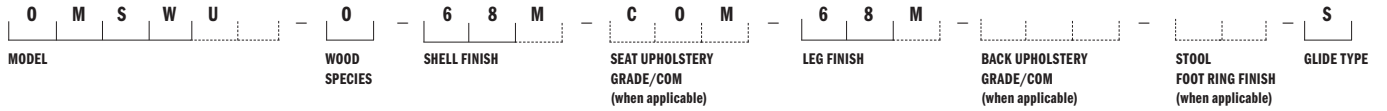

MODEL

Omena Side Chair, Upholstered Seat (OMSWU)

WOOD SPECIES

Oak (O)

SHELL FINISH

Weathered (68M)

SEAT UPHOLSTERY SELECTION

When applicable, enter upholstery grade, COM

LEG FINISH

Weathered (68M)

BACK UPHOLSTERY SELECTION

When applicable, enter upholstery grade, COM



OMENA SIDE CHAIR  
Design: 2B Studio, Will Oltman

OM5



Omena Side Chair	MODEL	LIST PRICE
Maple shell/base	OMSW-M	\$770
W 17.5 D 21 H 31 SH 18		Optional Glides: Add \$8.00 net per chair for a set of four (4). Optional Glides raise chair height .5 inch. Gradient Finishes Upcharge: \$168 List



Omena Side Chair	MODEL	LIST PRICE/GRADE	COM/COL	A	B	C	D	E	F	G	H	I	J	K	L
Maple shell/base, upholstered seat	OMSWU-M		\$904	944	964	984	1005	1025	1045	1065	1086	1106	1126	1146	1167
W 17.5 D 21 H 31 SH 18.5															

Optional Glides: Add \$8.00 net per chair for a set of four (4). Optional Glides raise chair height .5 inch.  
Gradient Finishes Upcharge: \$168 List  
COM Yardage: 0.5 yards, 1-2 seats  
Contact Leland Customer Experience for yardage requirements on textiles with repeats.  
For COL requirements please contact Leland Customer Experience.



Omena Side Chair	MODEL	LIST PRICE/GRADE	COM/COL	A	B	C	D	E	F	G	H	I	J	K	L
Maple shell/base, upholstered seat and back	OMSWUU-M		\$1039	1118	1158	1199	1239	1280	1320	1361	1402	1442	1483	1523	1564
W 17.5 D 21 H 31 SH 18.5															

Optional Glides: Add \$8.00 net per chair for a set of four (4). Optional Glides raise chair height .5 inch.  
Gradient Finishes Upcharge: \$168 List  
1 yard, 1-2 seat and backs  
Contact Leland Customer Experience for yardage requirements on textiles with repeats.  
For COL requirements please contact Leland Customer Experience.

To specify:  
Please refer to pages 3-4 for complete specifying information.  
Specify all products by their product code.



OMENA SIDE CHAIR  
Design: 2B Studio, Will Oltman

OM6



Omena Side Chair	MODEL	LIST PRICE
Oak shell/base	OMSW-0	\$857
W 17.5 D 21 H 31 SH 18	Optional Glides: Add \$8.00 net per chair for a set of four (4). Optional Glides raise chair height .5 inch.	



Omena Side Chair	MODEL	LIST PRICE/GRADE	COM/COL	A	B	C	D	E	F	G	H	I	J	K	L
Oak shell/base, upholstered seat	OMSWU-0	\$992	1031	1051	1072	1092	1112	1133	1153	1173	1193	1214	1234	1254	
W 17.5 D 21 H 31 SH 18.5	Optional Glides: Add \$8.00 net per chair for a set of four (4). Optional Glides raise chair height .5 inch. COM Yardage: 0.5 yards, 1-2 seats Contact Leland Customer Experience for yardage requirements on textiles with repeats. For COL requirements please contact Leland Customer Experience.														



Omena Side Chair	MODEL	LIST PRICE/GRADE	COM/COL	A	B	C	D	E	F	G	H	I	J	K	L
Oak shell/base, upholstered seat and back	OMSWUU-0	\$1126	1205	1246	1286	1327	1367	1408	1449	1489	1530	1570	1611	1651	
W 17.5 D 21 H 31 SH 18.5	Optional Glides: Add \$8.00 net per chair for a set of four (4). Optional Glides raise chair height .5 inch. 1 yard, 1-2 seat and backs Contact Leland Customer Experience for yardage requirements on textiles with repeats. For COL requirements please contact Leland Customer Experience.														

To specify:  
Please refer to pages 3-4 for complete specifying information.  
Specify all products by their product code.

OMENA COUNTER STOOL  
Design: 2B Studio, Will Oltman

OM7



**Omena Counter Stool**

MODEL

LIST PRICE

Maple shell

OMCW-M

\$1232

W 17.5 D 21 H 25 SH 24

Optional Glides: Add \$8.00 net per chair for a set of four (4). Optional Glides raise chair height .5 inch.



**Omena Counter Stool**

MODEL

LIST PRICE/  
GRADE

COM/COL

A

B

C

D

E

F

G

H

I

J

K

L

Maple shell,  
upholstered seat

OMCWU-M

\$1346

1386

1406

1426

1446

1467

1487

1507

1528

1548

1568

1588

1609

W 17.5 D 21 H 25.75 SH 24.75

Optional Glides: Add \$8.00 net per chair for a set of four (4). Optional Glides raise chair height .5 inch.  
COM yardage: 0.5 yards, 1-2 seats  
Contact Leland Customer Experience for yardage requirements on textiles with repeats.  
For COL requirements please contact Leland Customer Experience.



**Omena Counter Stool**

MODEL

LIST PRICE

Oak shell

OMCW-O

\$1379

W 17.5 D 21 H 25 SH 24

Optional Glides: Add \$8.00 net per chair for a set of four (4). Optional Glides raise chair height .5 inch.



**Omena Counter Stool**

MODEL

LIST PRICE/  
GRADE

COM/COL

A

B

C

D

E

F

G

H

I

J

K

L

Oak shell,  
upholstered seat

OMCWU-O

\$1495

1534

1554

1575

1595

1615

1635

1656

1676

1696

1717

1737

1757

W 17.5 D 21 H 25.75 SH 24.75

Optional Glides: Add \$8.00 net per chair for a set of four (4). Optional Glides raise chair height .5 inch.  
COM yardage: 0.5 yards, 1-2 seats  
Contact Leland Customer Experience for yardage requirements on textiles with repeats.  
For COL requirements please contact Leland Customer Experience.

To specify:

Please refer to pages 3-4 for complete specifying information. Specify all products by their product code.

Pricing Effective: February 2022

OMENA BAR STOOL  
Design: 2B Studio, Will Oltman

OM8



**Omena Bar Stool**

MODEL

LIST PRICE

Maple shell

OMBW-M

\$1449

W 17.5 D 21 H 31 SH 30

Optional Glides: Add \$8.00 net per chair for a set of four (4). Optional Glides raise chair height .5 inch.



**Omena Bar Stool**

MODEL

LIST PRICE/  
GRADE

COM/COL

A

B

C

D

E

F

G

H

I

J

K

L

Maple shell/base,  
upholstered seat

OMBWU-M

\$1583

1623

1643

1663

1683

1704

1724

1744

1765

1785

1805

1825

1846

W 17.5 D 21 H 31.75 SH 30.75

Optional Glides: Add \$8.00 net per chair for a set of four (4). Optional Glides raise chair height .5 inch.  
COM yardage: 0.5 yards, 1-2 seats  
Contact Leland Customer Experience for yardage requirements on textiles with repeats.  
For COL requirements please contact Leland Customer Experience.



**Omena Bar Stool**

MODEL

LIST PRICE

Oak shell

OMBW-O

\$1623

W 17.5 D 21 H 31 SH 30

Optional Glides: Add \$8.00 net per chair for a set of four (4). Optional Glides raise chair height .5 inch.



**Omena Bar Stool**

MODEL

LIST PRICE/  
GRADE

COM/COL

A

B

C

D

E

F

G

H

I

J

K

L

Oak shell,  
upholstered seat

OMBWU-O

\$1757

1797

1817

1837

1857

1878

1898

1918

1939

1959

1979

1999

2020

W 17.5 D 21 H 31.75 SH 30.75

Optional Glides: Add \$8.00 net per chair for a set of four (4). Optional Glides raise chair height .5 inch.  
COM yardage: 0.5 yards, 1-2 seats  
Contact Leland Customer Experience for yardage requirements on textiles with repeats.  
For COL requirements please contact Leland Customer Experience.

To specify:

Please refer to pages 3-4 for complete specifying information.  
Specify all products by their product code.

Pricing Effective: February 2022

OMENA BAR STOOL  
Design: 2B Studio, Will Oltman

OM9



**Omena Low Stool**

MODEL

LIST PRICE

Maple shell

OMLW-M

\$1179

W 16.5 D 12.09 H 19 SH 18

Optional Glides: Add \$8.00 net per chair for a set of four (4). Optional Glides raise chair height .5 inch.  
Gradient Finishes Upcharge: \$168 List



**Omena Low Stool**

MODEL

LIST PRICE/  
GRADE

COM/COL

A

B

C

D

E

F

G

H

I

J

K

L

Maple shell/base,  
upholstered seat

OMLWU-M

\$1293

1332

1353

1373

1393

1413

1434

1454

1474

1495

1515

1535

1555

W 17.83 D 13.53 H 19.75  
SH 18.75

Optional Glides: Add \$8.00 net per chair for a set of four (4). Optional Glides raise chair height .5 inch.  
Gradient Finishes Upcharge: \$168 List  
COM yardage: 0.5 yards, 1-2 seats  
Contact Leland Customer Experience for yardage requirements on textiles with repeats.  
For COL requirements please contact Leland Customer Experience.



**Omena Low Stool**

MODEL

LIST PRICE

Oak shell

OMLW-O

\$1326

W 16.5 D 12.09 H 19 SH 18

Optional Glides: Add \$8.00 net per chair for a set of four (4). Optional Glides raise chair height .5 inch.



**Omena Low Stool**

MODEL

LIST PRICE/  
GRADE

COM/COL

A

B

C

D

E

F

G

H

I

J

K

L

Oak shell,  
upholstered seat

OMLWU-O

\$1441

1481

1501

1521

1541

1562

1582

1602

1623

1643

1663

1683

1704

W 17.83 D 13.53 H 19.75  
SH 18.75

Optional Glides: Add \$8.00 net per chair for a set of four (4). Optional Glides raise chair height .5 inch.  
COM yardage: 0.5 yards, 1-2 seats  
Contact Leland Customer Experience for yardage requirements on textiles with repeats.  
For COL requirements please contact Leland Customer Experience.

To specify:

Please refer to pages 3-4 for complete specifying information.  
Specify all products by their product code.

Pricing Effective: February 2022

---

**5695 Eagle Drive, SE**  
**Grand Rapids,**  
**Michigan 49512**  
**616-975-9260**  
**[lelandfurniture.com](http://lelandfurniture.com)**

# Parfait II

## February 2022 Price List



# Parfait II

Table of Contents	PII2
Specification Information	PII3
Specification Example	PII4
Stacking Side Chair	PII5
Non-Stacking Side Chair	PII6
Mobile Stacking Side Chair	PII7
Mobile Non-Stacking Side Chair	PII9
Arm Chair	PII11
Mobile Arm Chair	PII12
Counter Chair	PII14
Bar Chair	PII15
Transport/Stacking Dolly	PII16

**Chair Model**

**STACKING SIDE CHAIR:**

DESCRIPTION	CODE
upholstered seat, wood back	PSSUW
wood seat, wood back	PSSWW
upholstered seat, wood back, upholstered back onlay	PSSUWU

**SIDE CHAIR:**

DESCRIPTION	CODE
upholstered seat, wood back	PSUW
wood seat, wood back	PSWW
upholstered seat, wood back, upholstered back onlay	PSUWU

**ARM CHAIR:**

DESCRIPTION	CODE
upholstered seat, wood back, polypropylene arm cap	PAUW
wood seat, wood back, polypropylene arm cap	PAWW
upholstered seat, wood back	
upholstered back onlay, polypropylene arm cap	PAUWU-P
upholstered seat, wood back	
upholstered back onlay, upholstered arm cap	PAUWU-U

**COUNTER CHAIR:**

DESCRIPTION	CODE
upholstered seat, wood back	PCUW
wood seat, wood back	PCWW
upholstered seat, wood back, upholstered back onlay	PCUWU

**BAR CHAIR:**

DESCRIPTION	CODE
upholstered seat, wood back	PBUW
wood seat, wood back	PBWW
upholstered seat, wood seat, upholstered back onlay	PBUWU

**MOBILE STACKING SIDE CHAIR:**

DESCRIPTION	CODE
upholstered seat, wood back	PMSSUW
wood seat, wood back	PMSSWW
upholstered seat, wood back, upholstered back onlay	PMSSUWU

**MOBILE SIDE CHAIR (NON-STACKING):**

DESCRIPTION	CODE
upholstered seat, wood back	PMSUW
wood seat, wood back	PMSWW
upholstered seat, wood back	PMSUWU

**MOBILE ARM CHAIR (NON-STACKING):**

DESCRIPTION	CODE
upholstered seat, wood back, polypropylene arm cap	PMAUW
wood seat, wood back, polypropylene arm cap	PMAWW
upholstered seat, wood back,	
upholstered back onlay, polypropylene arm cap	PMAUWU-P
upholstered seat, wood back,	
upholstered back onlay, upholstered arm cap	PMAUWU-U

**Upholstery Selection**

Please refer to Leland Textile Program which features textiles and leathers from the following partners:

- Camira
- Green Hides
- Carnegie
- Maharam
- CF Stinson
- Unika Vaev

The complete grade list can be found on our website or you can specify COM/COL. Due to the design of this product, it is recommended that all non pre-approved textile be tested for compatibility.

**Pricing Effective: February 2022**

**Seat and Back Wood Finish**

**STANDARD LELAND COLORS**

**CUSTOM SPECIFY** Custom (01)

\*Please note that Parfait II is NOT AVAILABLE in the following finishes:  
Natural Walnut Matte (08M), Natural Beech (09), Natural White Oak Matte (12M)

**Frame Finish**

DESCRIPTION	CODE	DESCRIPTION	CODE
Sterling	ST	Matte Mercury	MMR
Warm Grey	WG	Matte Mineral	MMN
Cool Grey	CG	Matte Burnish	MBN
Black	B	Matte Foundry	MFN
White	W		
Matte Gold Rush	MGR		
TEXTURED	CODE	TEXTURED	CODE
Soda Red Textured	SRT	Dolphin Textured	DLT
Oxford Textured	OXT	angerine Textured	TNT
Ice Blue Textured	IBT	Artic Textured	ART
Caribbean Textured	CBT	Ink Textured	INT
Limelight Textured	LLT		

**Arm Cap Type**

DESCRIPTION	CODE
Polypropylene	P
Upholstered	U

**Arm Cap Color (Polypropylene)**

DESCRIPTION	CODE
Black	B
Silver	S

**Glide Type or Caster Type for Mobile Chairs**

**STANDARD:**

DESCRIPTION	CODE
Nylon	S

**OPTIONAL:**

DESCRIPTION	CODE
Felt	FC
Floor Saver™ (for VCT type floors)	FS
Metal	M
Rubber	R

Please note that optional glides raise the chair height .5 inch.

**CASTER TYPE:**

DESCRIPTION	CODE
Hard floor caster	HF
Soft floor caster	SF



**Specifications required to create the product code**

- Model
- Seat Upholstery or Finish
- Back Finish
- Upholstered Back Onlay (when applicable)
- Frame Finish
- Arm Cap Type (when applicable)
- Arm Cap Color or Upholstery (when applicable)
- Glide or Caster Type

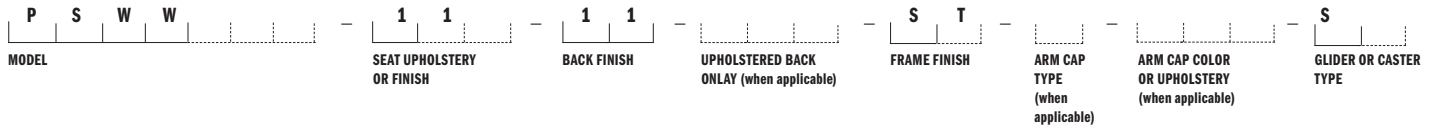

**MODEL**

Parfait II Side Chair -  
wood seat, wood back (PSWW)

**SEAT UPHOLSTERY OR FINISH**

Natural (11)

**BACK FINISH**

Natural (11)

**UPHOLSTERED BACK ONLAY**

When applicable, enter upholstery grade, COM or COL



**FRAME FINISH**

Sterling (ST)

**ARM CAP TYPE**

When applicable, enter arm cap type code

**ARM CAP COLOR OR UPHOLSTERY**

When applicable, enter color, upholstery grade, COM or COL



**PARFAIT II STACKING SIDE CHAIR**  
 Design: Bruce Sienkowski

**PII5**



**Parfait II**

**Stacking Side Chair**

	MODEL	LIST PRICE/GRADE	COM/COL	A	B	C	D	E	F	G	H	I	J	K	L
Upholstered seat, wood back	PSSUW		\$653	683	699	717	733	750	766	783	799	816	833	850	866

W 20.25 D 21.5 H 32.5 SH 19

Optional Glides: Add \$8.00 net per chair for a set of four (4). Optional Glides raise chair height .5 inch.  
 COM Yardage: 1 or 2 seats: .75 yard; 3 or 4 seats: 1.5 yards; 5 or 6 seats: 2.25 yards  
 Contact Leland Customer Experience for yardage requirements on textiles with repeats.  
 For COL requirements please contact Leland Customer Experience.



**Parfait II**

**Stacking Side Chair**

	MODEL	LIST PRICE
Wood seat, wood back	PSSWW	\$683

W 20.25 D 21.5 H 32.5 SH 18.5

Optional Glides: Add \$8.00 net per chair for a set of four (4). Optional Glides raise chair height .5 inch.



**Parfait II**

**Stacking Side Chair**

	MODEL	LIST PRICE/GRADE	COM/COL	A	B	C	D	E	F	G	H	I	J	K	L
Upholstered seat, wood back upholstered seat and back	PSSUWU	\$736		782	806	829	853	877	901	925	948	972	996	1019	1043

W 20.25 D 21.5 H 32.5 SH 19

Optional Glides: Add \$8.00 net per chair for a set of four (4). Optional Glides raise chair height .5 inch.  
 COM Yardage: 1 seat and back: .75 yard, 6 seats and backs: 3.5 yards  
 Contact Leland Customer Experience for yardage requirements on textiles with repeats.  
 For COL requirements please contact Leland Customer Experience.

**To specify:**  
 Please refer to pages 3-5 for complete specifying information.  
 Specify all products by their product code.

**Pricing Effective: February 2022**

# PARFAIT II NON-STACKING SIDE CHAIR

Design: Bruce Sienkowski

# PII6



## Parfait II

### Non-Stacking Side Chair

	MODEL	LIST PRICE/GRADE	COM/COL	A	B	C	D	E	F	G	H	I	J	K	L
Upholstered seat, wood back	PSUW		\$589	619	636	652	669	685	703	719	736	752	769	785	802

W 20.25 D 21.5 H 32.5 SH 19

Optional Glides: Add \$8.00 net per chair for a set of four (4). Optional Glides raise chair height .5 inch.  
 COM Yardage: 1 or 2 seats: .75 yard; 3 or 4 seats: 1.5 yards; 5 or 6 seats: 2.25 yards  
 Contact Leland Customer Experience for yardage requirements on textiles with repeats.  
 For COL requirements please contact Leland Customer Experience.



## Parfait II

### Non-Stacking Side Chair

	MODEL	LIST PRICE
Wood seat, wood back	PSWW	\$622

W 20.5 D 21.5 H 32.5 SH 18.5

Optional Glides: Add \$8.00 net per chair for a set of four (4). Optional Glides raise chair height .5 inch.



## Parfait II

### Non-Stacking Side Chair

	MODEL	LIST PRICE/ GRADE	COM/COL	A	B	C	D	E	F	G	H	I	J	K	L
Upholstered seat, wood back upholstered seat and back	PSUWU		\$691	737	761	784	808	831	855	880	903	927	951	974	998

W 20.5 D 21.5 H 32.5 SH 19

Optional Glides: Add \$8.00 net per chair for a set of four (4). Optional Glides raise chair height .5 inch.  
 COM Yardage: 1 seat and back: .75 yard, 6 seats and backs: 3.5 yards  
 Contact Leland Customer Experience for yardage requirements on textiles with repeats.  
 For COL requirements please contact Leland Customer Experience.

To specify:

Please refer to pages 3-5 for complete specifying information.  
 Specify all products by their product code.

Pricing Effective: February 2022

# PARFAIT II MOBILE STACKING SIDE CHAIR

Design: Bruce Sienkowski

# PII7

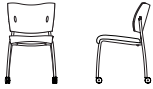

## Parfait II Mobile Stacking Side Chair

	MODEL	LIST PRICE/GRADE	COM/COL	A	B	C	D	E	F	G	H	I	J	K	L
Upholstered seat, wood back hard floor caster	PMSSUW-HF		\$787	817	835	851	868	884	901	917	933	951	968	984	1001

COM Yardage: 1 or 2 seats: .75 yard; 3 or 4 seats: 1.5 yards; 5 or 6 seats: 2.25 yards  
Contact Leland Customer Experience for yardage requirements on textiles with repeats.  
For COL requirements please contact Leland Customer Experience.

W 20.25 D 21.5 H 32.5 SH 19

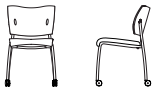

## Parfait II Mobile Stacking Side Chair

	MODEL	LIST PRICE/ GRADE	COM/COL	A	B	C	D	E	F	G	H	I	J	K	L
Upholstered seat, wood back soft floor caster	PMSSUW-SF		\$787	817	835	851	868	884	901	917	933	951	968	984	1001

COM Yardage: 1 or 2 seats: .75 yard; 3 or 4 seats: 1.5 yards; 5 or 6 seats: 2.25 yards  
Contact Leland Customer Experience for yardage requirements on textiles with repeats.  
For COL requirements please contact Leland Customer Experience.

W 20.5 D 21.5 H 32.5 SH 19

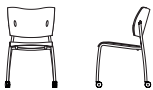

## Parfait II Mobile Stacking Side Chair

	MODEL	LIST PRICE
Wood seat, wood back hard floor caster	PMSSWW-HF	\$826

W 20.5 D 21.5 H 32.5 SH 18.5



## Parfait II Mobile Stacking Side Chair

	MODEL	LIST PRICE
Wood seat, wood back soft floor caster	PMSSWW-SF	\$826

W 20.5 D 21.5 H 32.5 SH 18.5

To specify:

Please refer to pages 3-5 for complete specifying information.  
Specify all products by their product code.

Pricing Effective: February 2022

# PARFAIT II MOBILE STACKING SIDE CHAIR

Design: Bruce Sienkowski

# PII8

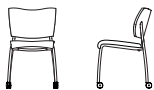

## Parfait II Mobile Stacking Side Chair

	MODEL	LIST PRICE/GRADE	COM/COL	A	B	C	D	E	F	G	H	I	J	K	L
Upholstered seat, wood back upholstered back onlay, hard floor caster	PMSSUWU-HF		\$870	916	940	964	987	1012	1035	1059	1083	1106	1130	1155	1178
W 20.25 D 21.5 H 32.5 SH 19		COM Yardage: 1 seat and back: .75 yard, 6 seats and backs: 3.5 yard Contact Leland Customer Experience for yardage requirements on textiles with repeats. For COL requirements please contact Leland Customer Experience.													

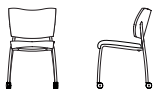

## Parfait II Mobile Stacking Side Chair

	MODEL	LIST PRICE/GRADE	COM/COL	A	B	C	D	E	F	G	H	I	J	K	L
Upholstered seat, wood back upholstered back onlay, soft floor caster	PMSSUWU-SF		\$870	916	940	964	987	1012	1035	1059	1083	1106	1130	1155	1178
W 20.25 D 21.5 H 32.5 SH 19		COM Yardage: 1 seat and back: .75 yard, 6 seats and backs: 3.5 yard Contact Leland Customer Experience for yardage requirements on textiles with repeats. For COL requirements please contact Leland Customer Experience.													

To specify:

Please refer to pages 3-5 for  
complete specifying information.

Specify all products by their  
product code.

Pricing Effective: February 2022

# PARFAIT II MOBILE NON-STACKING SIDE CHAIR

Design: Bruce Sienkowski

# PII9

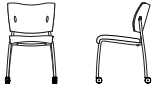

## Parfait II Mobile

### Non-Stacking Side Chair

	MODEL	LIST PRICE/GRADE	COM/COL	A	B	C	D	E	F	G	H	I	J	K	L
Upholstered seat, wood back, hard floor caster	PMSUW-HF	\$719		749	765	782	798	815	831	849	865	882	898	915	931

W 20.25 D 21.5 H 32.5 SH 19

COM Yardage: 1 or 2 seats: .75 yard; 3 or 4 seats: 1.5 yards; 5 or 6 seats: 2.25 yards  
Contact Leland Customer Experience for yardage requirements on textiles with repeats.  
For COL requirements please contact Leland Customer Experience.

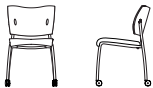

## Parfait II Mobile

### Non-Stacking Side Chair

	MODEL	LIST PRICE/ GRADE	COM/COL	A	B	C	D	E	F	G	H	I	J	K	L
Upholstered seat, wood back, soft floor caster	PMSUW-SF	\$719		749	765	782	798	815	831	849	865	882	898	915	931

W 20.5 D 21.5 H 32.5 SH 19

COM Yardage: 1 or 2 chair seats and back onlays: .75 yard; 3 or 4 chair seats and back onlays: 1.5 yards;  
5 or 6 Chair seats and back onlays: 2.25 yards  
Contact Leland Customer Experience for yardage requirements on textiles with repeats.  
For COL requirements please contact Leland Customer Experience.

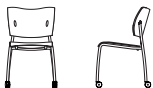

## Parfait II Mobile

### Non-Stacking Side Chair

	MODEL	LIST PRICE
Wood seat, wood back, hard floor caster	PMSWW-HF	\$758
W 20.5 D 21.5 H 32.5 SH 18.5		



## Parfait II Mobile

### Non-Stacking Side Chair

	MODEL	LIST PRICE
Wood seat, wood back soft floor caster	PMSSWW-SF	\$758
W 20.5 D 21.5 H 32.5 SH 18.5		

To specify:

Please refer to pages 3-5 for complete specifying information.

Specify all products by their product code.

Pricing Effective: February 2022

# PARFAIT II MOBILE NON-STACKING SIDE CHAIR

Design: Bruce Sienkowski

# PII10

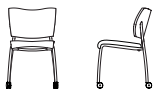

## Parfait II Mobile

### Non-Stacking Side Chair

	MODEL	LIST PRICE/GRADE	COM/COL	A	B	C	D	E	F	G	H	I	J	K	L
Upholstered seat, wood back upholstered back onlay, hard floor caster	PMSUWU-HF		\$826	872	896	919	943	968	991	1015	1039	1062	1086	1111	1134
W 20.25 D 21.5 H 32.5 SH 19															

COM Yardage: 1 seat and back: .75 yard, 6 seats and backs: 3.5 yards  
 Contact Leland Customer Experience for yardage requirements on textiles with repeats.  
 For COL requirements please contact Leland Customer Experience.

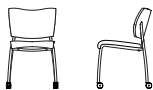

## Parfait II Mobile

### Non-Stacking Side Chair

	MODEL	LIST PRICE/GRADE	COM/COL	A	B	C	D	E	F	G	H	I	J	K	L
Upholstered seat, wood back upholstered back onlay, soft floor caster	PMSUWU-SF		\$826	872	896	919	943	968	991	1015	1039	1062	1086	1111	1134
W 20.25 D 21.5 H 32.5 SH 19															

COM Yardage: 1 seat and back: .75 yard, 6 seats and backs: 3.5 yards  
 Contact Leland Customer Experience for yardage requirements on textiles with repeats.  
 For COL requirements please contact Leland Customer Experience.

To specify:

Please refer to pages 3-5 for complete specifying information.

Specify all products by their product code.

Pricing Effective: February 2022

**PARFAIT II ARM CHAIR**  
Design: Bruce Sienkowski

**PII11**



Parfait II Arm Chair	MODEL	LIST PRICE/GRADE	COM/COL	A	B	C	D	E	F	G	H	I	J	K	L
Upholstered seat, wood back	PAUW		\$826	855	872	888	906	923	939	955	972	988	1005	1023	1039
W 25.5 D 21.5 H 32.5 SH 19 AH 27		Optional Glides: Add \$8.00 net per chair for a set of four (4). Optional Glides raise chair height .5 inch. COM Yardage: 1 or 2 seats: .75 yard; 3 or 4 seats: 1.5 yards; 5 or 6 seats: 2.25 yards Contact Leland Customer Experience for yardage requirements on textiles with repeats. For COL requirements please contact Leland Customer Experience.													



Parfait II Arm Chair	MODEL	LIST PRICE
Wood seat, wood back	PAWW	\$855
W 25.5 D 21.5 H 32.5 SH 18.5 AH 18.5		Optional Glides: Add \$8.00 net per chair for a set of four (4). Optional Glides raise chair height .5 inch.



Parfait II Arm Chair	MODEL	LIST PRICE/GRADE	COM/COL	A	B	C	D	E	F	G	H	I	J	K	L
Upholstered seat, wood back Upholstered back onlay, polypropylene arm cap	PAUWU-P		\$888	936	959	983	1006	1030	1054	1078	1102	1126	1149	1173	1196
W 25.5 D 21.5 H 32.5 SH 19 AH 27		Optional Glides: Add \$8.00 net per chair for a set of four (4). Optional Glides raise chair height .5 inch. COM Yardage: 1 seat and back: .75 yard, 6 seats and backs: 3.5 yards Contact Leland Customer Experience for yardage requirements on textiles with repeats. For COL requirements please contact Leland Customer Experience.													



Parfait II Arm Chair	MODEL	LIST PRICE/GRADE	COM/COL	A	B	C	D	E	F	G	H	I	J	K	L
Upholstered seat, wood back Upholstered back onlay, upholstered arm cap	PAUWU-U		\$937	983	1006	1030	1054	1078	1102	1126	1149	1173	1196	1220	1245
W 25.5 D 21.5 H 32.5 SH 19 AH 27		Optional Glides: Add \$8.00 net per chair for a set of four (4). Optional Glides raise chair height .5 inch. upholstered arm cap COM Yardage: 1 seat and back: .75 yard, 6 seats and backs: 3.5 yards, 1 or 2 pairs arm caps:.25 yard Contact Leland Customer Experience for yardage requirements on textiles with repeats. For COL requirements please contact Leland Customer Experience..													

**To specify:**  
Please refer to pages 3-5 for complete specifying information.  
Specify all products by their product code.



PARFAIT II MOBILE ARM CHAIR  
Design: Bruce Sienkowski

PII12



Parfait II Mobile Arm Chair	MODEL	LIST PRICE/GRADE	COM/COL	A	B	C	D	E	F	G	H	I	J	K	L
Upholstered seat, wood back, polypropylene arm cap, hard floor caster	PMAUW-P-HF	\$973		1003	1019	1036	1053	1070	1086	1103	1119	1136	1152	1170	1186
W 25.5 D 21.5 H 32.5 SH 19 AH 27		COM Yardage: 1 or 2 seats: .75 yard; 3 or 4 seats: 1.5 yards; 5 or 6 seats: 2.25 yards Contact Leland Customer Experience for yardage requirements on textiles with repeats. For COL requirements please contact Leland Customer Experience.													



Parfait II Mobile Arm Chair	MODEL	LIST PRICE/GRADE	COM/COL	A	B	C	D	E	F	G	H	I	J	K	L
Upholstered seat, wood back, polypropylene arm cap, soft floor caster	PMAUW-P-SF	\$973		1003	1019	1036	1053	1070	1086	1103	1119	1136	1152	1170	1186
W 25.5 D 21.5 H 32.5 SH 19 AH 27		COM Yardage: 1 or 2 chair seats and back onlays: .75 yard; 3 or 4 chair seats and back onlays: 1.5 yards; 5 to 6 Chair seats and back onlays: 2.25 yards Contact Leland Customer Experience for yardage requirements on textiles with repeats. For COL requirements please contact Leland Customer Experience.													



Parfait II Mobile Arm Chair	MODEL	LIST PRICE
Wood seat, wood back, polypropylene arm cap, hard floor caster	PMAWW-P-HF	\$1013
W 25.5 D 21.5 H 32.5 SH 18.5		



Parfait II Mobile Arm Chair	MODEL	LIST PRICE
Wood seat, wood back, polypropylene arm cap, soft floor caster	PMAWW-P-SF	\$1013
W 25.5 D 21.5 H 32.5 SH 18.5		

To specify:  
Please refer to pages 3-5 for complete specifying information.  
Specify all products by their product code.

# PARFAIT II MOBILE ARM CHAIR

Design: Bruce Sienkowski

# PII13



## Parfait II Mobile Arm Chair

	MODEL	LIST PRICE/ GRADE	COM/COL	A	B	C	D	E	F	G	H	I	J	K	L
Upholstered seat, Upholstered back onlay, upholstered arm cap, hard floor caster	PMAUWU-U-HF		\$1081	1127	1150	1174	1198	1222	1246	1269	1293	1317	1340	1365	1389
W 25.5 D 21.5 H 32.5 SH 19 AH 27		COM Yardage: 1 seat and back: .75 yard, 6 seats and backs: 3.5 yards 2 pairs armcaps:.25 yard Contact Leland Customer Experience for yardage requirements on textiles with repeats. For COL requirements please contact Leland Customer Experience.													



## Parfait II Mobile Arm Chair

	MODEL	LIST PRICE/ GRADE	COM/COL	A	B	C	D	E	F	G	H	I	J	K	L
Upholstered seat, Upholstered back onlay, upholstered arm cap, soft floor caster	PMAUWU-U-SF		\$1081	1127	1150	1174	1198	1222	1246	1269	1293	1317	1340	1365	1389
W 25.5 D 21.5 H 32.5 SH 19 AH 27		COM Yardage: 1 seat and back: .75 yard, 6 seats and backs: 3.5 yards 2 pairs armcaps:.25 yard Contact Leland Customer Experience for yardage requirements on textiles with repeats. For COL requirements please contact Leland Customer Experience.													



## Parfait II Mobile Arm Chair

	MODEL	LIST PRICE/ GRADE	COM/COL	A	B	C	D	E	F	G	H	I	J	K	L
Upholstered seat, Upholstered back onlay, polypropylene arm cap, hard floor caster	PMAUWU-P-HF		\$1032	1079	1103	1127	1150	1174	1198	1222	1246	1269	1293	1317	1340
W 25.5 D 21.5 H 32.5 SH 19 AH 27		COM Yardage: 1 seat and back: .75 yard, 6 seats and backs: 3.5 yards Contact Leland Customer Experience for yardage requirements on textiles with repeats. For COL requirements please contact Leland Customer Experience.													



## Parfait II Mobile Arm Chair

	MODEL	LIST PRICE/ GRADE	COM/COL	A	B	C	D	E	F	G	H	I	J	K	L
Upholstered seat, Upholstered back onlay, polypropylene arm cap, soft floor caster	PMAUWU-P-SF		\$1032	1079	1103	1127	1150	1174	1198	1222	1246	1269	1293	1317	1340
W 25.5 D 21.5 H 32.5 SH 19 AH 27		COM Yardage: 1 seat and back: .75 yard, 6 seats and backs: 3.5 yards Contact Leland Customer Experience for yardage requirements on textiles with repeats. For COL requirements please contact Leland Customer Experience.													

**To specify:**  
 Please refer to pages 3-5 for complete specifying information.  
 Specify all products by their product code.

**PARFAIT II COUNTER CHAIR**  
 Design: Bruce Sienkowski

**PII14**



Parfait II Counter Chair	MODEL	LIST PRICE/GRADE	COM/COL	A	B	C	D	E	F	G	H	I	J	K	L
Upholstered seat, wood back	PCUW	\$819		849	865	882	898	915	931	948	965	982	998	1015	1031

W 19.5 D 24 H 39 SH 25.5

Optional Glides: Add \$8.00 net per chair for a set of four (4). Optional Glides raise chair height .5 inch.  
 COM Yardage: 1 or 2 seats: .75 yard; 3 or 4 seats: 1.5 yards; 5 or 6 seats: 2.25 yards  
 Contact Leland Customer Experience for yardage requirements on textiles with repeats.  
 For COL requirements please contact Leland Customer Experience.



Parfait II Counter Chair	MODEL	LIST PRICE
Wood seat, wood back	PCWW	\$855

W 19.5 D 24 H 39 SH 25

Optional Glides: Add \$8.00 net per chair for a set of four (4). Optional Glides raise chair height .5 inch.



Parfait II Counter Chair	MODEL	LIST PRICE/GRADE	COM/COL	A	B	C	D	E	F	G	H	I	J	K	L
Upholstered seat, wood back upholstered back onlay	PCUWU	\$883		929	953	976	1001	1025	1048	1072	1096	1119	1144	1167	1191

W 19.5 D 24 H 39 SH 25.5

Optional Glides: Add \$8.00 net per chair for a set of four (4). Optional Glides raise chair height .5 inch.  
 COM Yardage: 1 seat and back: .75 yard, 6 seats and backs: 3.5 yards  
 Contact Leland Customer Experience for yardage requirements on textiles with repeats.  
 For COL requirements please contact Leland Customer Experience.

**To specify:**  
 Please refer to pages 3-5 for  
 complete specifying information.  
 Specify all products by their  
 product code.

**Pricing Effective: February 2022**

**PARFAIT II BAR CHAIR**  
Design: Bruce Sienkowski

**PII15**



**Parfait II Bar Chair**

	MODEL	LIST PRICE/GRADE	COM/COL	A	B	C	D	E	F	G	H	I	J	K	L
Upholstered seat, wood back	PBUW	\$833		863	880	896	913	929	946	962	980	996	1013	1029	1046

W 19.5 D 24 H 44 SH 31.5

Optional Glides: Add \$8.00 net per chair for a set of four (4). Optional Glides raise chair height .5 inch.  
Yardage: 1 or 2 seats: .75 yard; 3 or 4 seats: 1.5 yards; 5 or 6 seats: 2.25 yards  
Contact Leland Customer Experience for yardage requirements on textiles with repeats.  
For COL requirements please contact Leland Customer Experience.

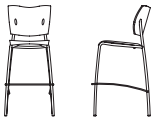

**Parfait II Bar Chair**

	MODEL	LIST PRICE
Wood seat, wood back	PBWW	\$872

W 19.5 D 24.5 H 44 SH 31

Optional Glides: Add \$8.00 net per chair for a set of four (4). Optional Glides raise chair height .5 inch.



**Parfait II Bar Chair**

	MODEL	LIST PRICE/GRADE	COM/COL	A	B	C	D	E	F	G	H	I	J	K	L
Upholstered seat, wood back, upholstered back onlay	PBUWU	\$895		941	965	988	1013	1036	1060	1084	1107	1131	1156	1179	1203

W 19.5 D 24 H 44 SH 31.5

Optional Glides: Add \$8.00 net per chair for a set of four (4). Optional Glides raise chair height .5 inch.  
COM Yardage: 1 seat and back: .75 yard, 6 seats and backs: 3.5 yards  
Contact Leland Customer Experience for yardage requirements on textiles with repeats.  
For COL requirements please contact Leland Customer Experience.

**To specify:**  
Please refer to pages 3-5 for complete specifying information.  
Specify all products by their product code.

**Pricing Effective: February 2022**

PARFAIT II TRANSPORT/STACKING DOLLY  
 Design: Bruce Sienkowski

PII16

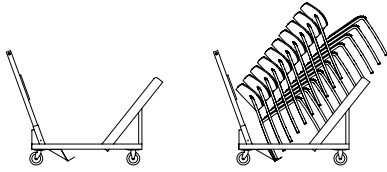

**Parfait II Transport/  
 Stacking Dolly**

**MODEL**

**LIST PRICE**

PSSD

Black Finish

\$942

W 25 D 57 H 44 (empty)

With 10 stacking chairs:

W 25 D 68 H 63

Parfait II Transport/Stacking Dolly handles up to 10 Parfait II stacking side chairs.

Please note that only the stacking version of the side chair will stack on the floor or Transport/Stacking Dolly.

To specify:

Please refer to pages 3-5 for complete specifying information.

Specify all products by their product code.

Pricing Effective: February 2022

---

**5695 Eagle Drive, SE  
Grand Rapids,  
Michigan 49512  
616-975-9260  
lelandfurniture.com**

# Pluto

## February 2022 Price List



# Pluto

Table of Contents	PB2
Specification Information	PB3
Specification Example	PB4
Bench	PB5
Auxiliary Option	PB6



**Bench Model**

DESCRIPTION	CODE
Pluto	PT

**Upholstery Selection**

Please refer to Leland Textile Program which features textiles from the following partners:

- Camira
- Carnegie
- CF Stinson
- Green Hides
- Maharam
- Unika Vaev

The complete grade list can be found on our website or you can specify COM/COL. Due to the design of this product, it is recommended that all non pre-approved textile be tested for compatibility.

**Upholstery Requirements**

With a choice of textile combinations, Pluto encourages design creativity. Please note that requirements vary by combination. The graded price of the combined yardage will be calculated using the highest grade textile selected.

TEXTILE REQUIREMENTS	YARDAGE
One textile, entire bench:	3.25 yards
Two/Three textile combination	
Seat:	1 yard
Top:	1 yard
Side:	1.25 yards

**Plinth Finish: Powdercoat and Chrome**

DESCRIPTION	CODE
Sterling	ST
Warm Grey	WG
Cool Grey	CG
Black	B
White	W
Matte Gold Rush	MGR
Matte Mercury	MMR
Matte Mineral	MMN
Matte Burnish	MBN
Matte Foundry	MFN
Brushed Chrome	BC

**Auxiliary Options**

Floor mount must be specified at the time of the bench order.

DESCRIPTION	CODE
Floor mount	PTFM

**Glides**

Pluto glides are poly.

**Shipment Detail**

200 pounds of weight ballast is shipped separately from the Pluto bench and is required to be installed at the final delivery location.

**Specifications required to create the product code**

- Model
- Seat Upholstery
- Top Upholstery
- Side Upholstery
- Plinth Finish
- Floor Mount (when applicable)

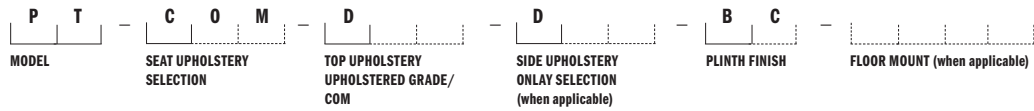

**MODEL**

Pluto (PT)

**SEAT UPHOLSTERY**

COM (COM)

**TOP UPHOLSTERY**

Grade D (D)

**SIDE UPHOLSTERY**

Grade D (D)

**PLINTH FINISH**

Brushed Chrome (BC)

**FLOOR MOUNT**

When applicable, enter Pluto Floor Mount Code



PLUTO BENCH  
Design: Simon Pengelly

PB5

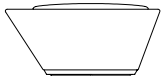

Pluto Bench	MODEL	LIST PRICE/ GRADE	COM/COL	A	B	C	D	E	F	G	H	I	J	K	L	
Powder coat plinth	PT-__	Powder Coat	\$1515	1718	1820	1922	2024	2125	2227	2329	2431	2533	2635	2736	2838	
W 34 D 37.75 H 16		COM REQUIREMENTS VARY BY COMBINATION SELECTED.														
		TEXTILE REQUIREMENTS:						YARDAGE								
		One textile, entire bench:						3.25 yards								
		Two/Three textile combination														
		Seat:						1 yard								
		Top:						1 yard								
		Side:						1.25 yards								

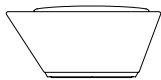

Pluto Bench	MODEL	LIST PRICE/ GRADE	COM/COL	A	B	C	D	E	F	G	H	I	J	K	L	
Brushed chrome plinth	PT-BC	Brushed Chrome	\$1671	1873	1975	2077	2179	2281	2383	2484	2586	2688	2790	2892	2994	
W 34 D 37.75 H 16		COM REQUIREMENTS VARY BY COMBINATION SELECTED.														
		TEXTILE REQUIREMENTS:						YARDAGE								
		One textile, entire bench:						3.25 yards								
		Two/Three textile combination														
		Seat:						1 yard								
		Top:						1 yard								
		Side:						1.25 yards								

To specify:  
Please refer to pages 3-4 for  
complete specifying information.  
Specify all products by their  
product code.

# PLUTO BENCH AUXILIARY OPTION

Design: Simon Pengelly

# PB6

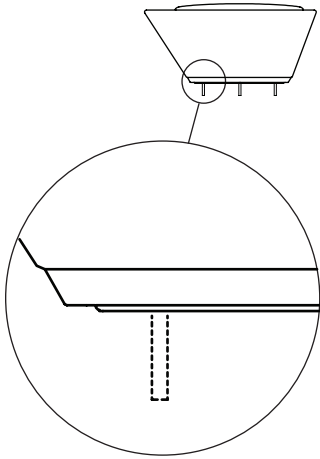

<b>Pluto Floor Mount</b>	<b>MODEL</b>	<b>FRAME FINISH</b>	<b>LIST PRICE</b>
	PTFM	Powder Coat	\$155

Due to the variety of floor surfaces on which the Pluto Bench may be installed, floor mount fasteners are not supplied by Leland International. The Pluto Bench floor mount feature consists of three .5" thru holes designed to use .3125" or .375" threaded studs. Leland International recommends at least 2" of exposed thread length from the floor surface.

Responsibility of fastener choice is the customers.

Floor Mount must be specified at the time of purchasing.

The Floor Mount cannot be added later in the field.

To specify:

Please refer to pages 3-4 for complete specifying information.

Specify all products by their product code.

Pricing Effective: February 2022

---

**5695 Eagle Drive, SE**  
**Grand Rapids,**  
**Michigan 49512**  
**616-975-9260**  
**[lelandfurniture.com](http://lelandfurniture.com)**

# Quarry

## February 2022 Price List



# Quarry

Table of Contents	QR2
Bench Specification Information	QR3
Bench Specification Example	QR4
Benches	QR5
Collaborative Work Tools Specification Information	QR6
Collaborative Work Tools Specification Example	QR7
Collaborative Work Tools	QR8
Quarry Groupings	QR9

**Bench Model**

DESCRIPTION	CODE
Flint	QF
Mica	QM
Shale	QS
Quartz	QQ

**Upholstery Selection**

Please refer to Leland Textile Program which features textiles and leathers from the following partners:

- Camira
- Carnegie
- CF Stinson
- Green Hides
- Maharam
- Unika Vaev

The complete grade list can be found at [www.lelandfurniture.com/ecatalog](http://www.lelandfurniture.com/ecatalog) or you can specify COM/COL. Due to the design of this product, it is recommended that all non pre-approved textile be tested for compatibility.

**Stitching Detail**

DESCRIPTION	CODE
Basic (Recommended for patterned textiles)	B
Premium (Standard stitch on Quarry Benches)	P

**Glide Selection**

**STANDARD GLIDES:**

DESCRIPTION	CODE
Poly	P

**OPTIONAL GLIDES:**

DESCRIPTION	CODE
Felt	F

**Auxiliary Options**

DESCRIPTION	CODE
Weight Ballast (50 lbs.)	WB

**Plinth Finish**

All plinths are stainless steel.



**Specifications required to create the product code**

- Model
- Upholstery Selection
- Stitching Detail
- Glide Selection
- Auxiliary Option (when applicable)



**MODEL**

Quarry Flint (QF)

**UPHOLSTERY SELECTION**

Enter upholstery grade or COM.  
Grade D (D)

**STITCHING DETAIL**

Premium (P)

**GLIDE SELECTION**

Poly (P)

**AUXILIARY OPTION**

When applicable



**QUARRY BENCHES**  
Design: Bruce Sienkowski

**QR5**



<b>Flint</b>	<b>MODEL</b>	<b>LIST PRICE/GRADE</b>	<b>COM/COL</b>	<b>A</b>	<b>B</b>	<b>C</b>	<b>D</b>	<b>E</b>	<b>F</b>	<b>G</b>	<b>H</b>	<b>I</b>	<b>J</b>	<b>K</b>	<b>L</b>
W 19 D 18 H 19	QF		\$1166	1269	1320	1373	1425	1477	1529	1582	1633	1686	1737	1790	1842

Optional Glides: Add \$8.00 net per bench for a set of four (4). Optional Glides raise bench height .5 inch.  
 Contrasting Stitch: Add \$25 net per bench - specify black (-CSB) or white thread (-CSW)  
 COM Yardage: 1.25 yards  
 Contact Leland Customer Experience for yardage requirements on textiles with repeats.



<b>Mica</b>	<b>MODEL</b>	<b>LIST PRICE/GRADE</b>	<b>COM/COL</b>	<b>A</b>	<b>B</b>	<b>C</b>	<b>D</b>	<b>E</b>	<b>F</b>	<b>G</b>	<b>H</b>	<b>I</b>	<b>J</b>	<b>K</b>	<b>L</b>
W 19 D 20 H 19	QM		\$1166	1269	1320	1373	1425	1477	1529	1582	1633	1686	1737	1790	1842

Optional Glides: Add \$8.00 net per bench for a set of four (4). Optional Glides raise bench height .5 inch.  
 Contrasting Stitch: Add \$25 net per bench - specify black (-CSB) or white thread (-CSW)  
 COM Yardage: 1.25 yards  
 Contact Leland Customer Experience for yardage requirements on textiles with repeats.

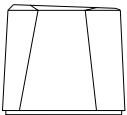

<b>Shale</b>	<b>MODEL</b>	<b>LIST PRICE/GRADE</b>	<b>COM/COL</b>	<b>A</b>	<b>B</b>	<b>C</b>	<b>D</b>	<b>E</b>	<b>F</b>	<b>G</b>	<b>H</b>	<b>I</b>	<b>J</b>	<b>K</b>	<b>L</b>
W 22 D 28.5 H 25.25	QS		\$1282	1424	1494	1565	1635	1706	1777	1847	1918	1988	2059	2130	2200

Optional Glides: Add \$8.00 net per bench for a set of four (4). Optional Glides raise bench height .5 inch.  
 Contrasting Stitch: Add \$25 net per bench - specify black (-CSB) or white thread (-CSW)  
 COM Yardage: 2.25 yards  
 Contact Leland Customer Experience for yardage requirements on textiles with repeats.

<b>Quartz</b>	<b>MODEL</b>	<b>LIST PRICE/GRADE</b>	<b>COM/COL</b>	<b>A</b>	<b>B</b>	<b>C</b>	<b>D</b>	<b>E</b>	<b>F</b>	<b>G</b>	<b>H</b>	<b>I</b>	<b>J</b>	<b>K</b>	<b>L</b>
W 28.5 D 26 H 16.5	QQ		\$1282	1381	1430	1480	1529	1578	1628	1677	1727	1777	1826	1875	1925

Optional Glides: Add \$8.00 net per bench for a set of four (4). Optional Glides raise bench height .5 inch.  
 Contrasting Stitch: Add \$25 net per bench - specify black (-CSB) or white thread (-CSW)  
 COM Yardage: 1.75 yards  
 Contact Leland Customer Experience for yardage requirements on textiles with repeats.

<b>Weight Ballast</b>	<b>MODEL</b>	<b>LIST PRICE</b>
50 lbs.	WB	\$76

To specify:  
 Please refer to pages 3-4 for complete specifying information.  
 Specify all products by their product code.

### Collaborative Work Space Model

DESCRIPTION	CODE
Flint bench with tablet	QFT
Mobile tablet stand	QMT
Power module	QPM

### Tablet Support or Mobile Tablet Column Finish

DESCRIPTION	CODE
White	W
Sterling	ST
Black	B

### Upholstery Selection

Please refer to Leland Textile Program which features textiles and leathers from the following partners:

- Camira
- Green Hides
- Carnegie
- Maharam
- CF Stinson
- Unika Vaev

The complete grade list can be found on our website or you can specify COM/COL. Due to the design of this product, it is recommended that all non pre-approved textile be tested for compatibility.

### Stitching Detail

DESCRIPTION	CODE
Basic (Recommended for patterned textiles)	B
Premium (Standard stitch on Quarry Benches)	P

### Top Surface

DESCRIPTION	CODE
Corian®	C
Wood	V
Laminate	L

### Top Surface Finish or Color

#### CORIAN® TOPS:

DESCRIPTION	CODE
Black Corian®	CB
White Corian®	CW
Grey Corian®	CG

#### WOOD TOPS:

#### STANDARD LELAND COLORS

\*Natural Finish specify Natural 11

\*\*Custom Finish specify Custom 01

#### LAMINATE TOPS:

DESCRIPTION	CODE
Black Laminate	LBK
White Laminate	LWH
Grey Laminate	LG

Note that Collaborative Work Tool edges are finished to match for wood tops and Natural 11 for laminate tops.

### Glide Selection

#### STANDARD:

DESCRIPTION	CODE
Poly	P

#### OPTIONAL:

DESCRIPTION	CODE
Felt	F

### Power Options

DESCRIPTION	CODE
1 Power Unit, three (3) 120v AC receptacles with 7'6" cord	3P
1 Power Unit, four (4) 120v AC receptacles, one (1) USB simplex charger with 7'6" cord	4P

### Freight Note

Due to the size and nature of Quarry Collaborative Work Tools, the Freight Program does not apply to this product. Please contact Customer Experience for a quote.

**Specifications required to create the product code**

- Model
- Tablet Support or Mobile Tablet Stand Column Finish (when applicable)
- Upholstery Selection (when applicable)
- Stitching Detail (when applicable)
- Top Surface
- Top Surface Finish or Color
- Glide Selection
- Power Options (when applicable)



**MODEL**

Quarry Mobile Tablet Stand (QMT)

**TABLET SUPPORT OR MOBILE STAND COLUMN FINISH**

White (W)

**UPHOLSTERY SELECTION**

When applicable, enter upholstery grade or COM

**STITCHING DETAIL**

When applicable

**TOP SURFACE**

Corian® (C)

**TOP SURFACE FINISH OR COLOR**

Grey Corian® (CG)

**GLIDE SELECTION**

When applicable

**POWER OPTIONS**

When applicable



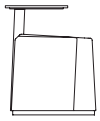

<b>Flint Bench with Tablet</b>				<b>MODEL</b>	<b>LIST PRICE/ GRADE</b>	<b>COM/COL</b>	<b>A</b>	<b>B</b>	<b>C</b>	<b>D</b>	<b>E</b>	<b>F</b>	<b>G</b>	<b>H</b>	<b>I</b>	<b>J</b>	<b>K</b>	<b>L</b>
W 25.6	D 21.5	H 25.5	SH 19	QFT	Corian®	\$2298	2403	2457	2510	2563	2616	2670	2724	2776	2830	2883	2937	2989
					Wood	\$2240	2345	2399	2451	2505	2558	2612	2665	2718	2772	2825	2878	2932
					Laminate	\$2183	2289	2343	2396	2449	2503	2556	2609	2662	2716	2770	2822	2876

Optional Glides: Add \$8.00 net per bench for a set of four (4). Optional Glides raise bench height .5 inch.  
COM Yardage: 1.75 yards  
Contact Leland Customer Experience for yardage requirements on textiles with repeats.

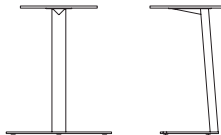

<b>Mobile Tablet Stand</b>			<b>MODEL</b>	<b>FRAME FINISH</b>	<b>LIST PRICE</b>
W 24.7	D 17	H 26	QMT	Corian®	\$1263
				Wood	\$1168
				Laminate	\$1113

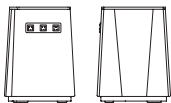

<b>Power Module</b>				<b>MODEL</b>	<b>LIST PRICE/ GRADE</b>	<b>COM/COL</b>	<b>A</b>	<b>B</b>	<b>C</b>	<b>D</b>	<b>E</b>	<b>F</b>	<b>G</b>	<b>H</b>	<b>I</b>	<b>J</b>	<b>K</b>	<b>L</b>
W 16.5	D 17.25	H 22.4		QPM - _ P	Corian®	\$2603	2709	2762	2816	2868	2922	2976	3029	3082	3135	3189	3242	3295
three (3) AC receptacles with 7'6" power cord or four (4) AC receptacles, one (1) USB simplex charger, with 7'6" power cord					Wood	\$2537	2642	2696	2748	2802	2855	2909	2962	3015	3069	3122	3175	3229
					Laminate	\$2483	2589	2642	2696	2748	2802	2855	2909	2962	3015	3069	3122	3175

Optional Glides: Add \$8.00 net per bench for a set of four (4). Optional Glides raise bench height .5 inch.  
one (1) USB simplex charger , COM Yardage: 1.5 yards  
with 7'6" power cord Contact Leland Customer Experience for yardage requirements on textiles with repeats.

To specify:  
Please refer to pages 6-7 for complete specifying information.  
Specify all products by their product code.

# QUARRY BENCH GROUPINGS

Design: Bruce Sienkowski

# QR9

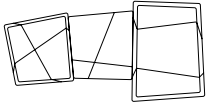

## Example A

### BENCHES

### TOTAL COM LIST PRICE

Flint (QF)

\$3611

Mica (QM)

Shale (QS)

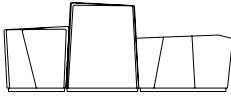
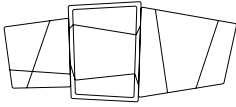

## Example B

### BENCHES

### TOTAL COM LIST PRICE

Mica (QM)

\$3727

Shale (QS)

Quartz (QQ)

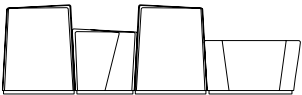
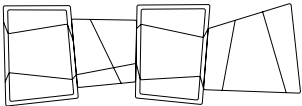

## Example C

### BENCHES

### TOTAL COM LIST PRICE

Shale (QS)

\$5008

Mica (QM)

Shale (QS)

Quartz (QQ)

Please note that example groups are provided as a specification tool. Example groups are shown from top and side profiles. Quarry benches must be ordered as separate line items for each unique model and/or finish specification.

#### To specify:

Please refer to pages 3-4 for complete specifying information.

Specify all products by their product code.

# QUARRY BENCH GROUPINGS

Design: Bruce Sienkowski

# QR10

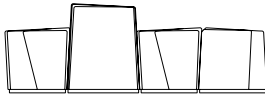
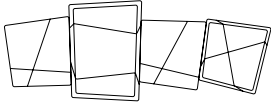

## Example D

### BENCHES

### TOTAL COM LIST PRICE

Mica (QM)

\$4777

Shale (QS)

Mica (QM)

Flint (QF)

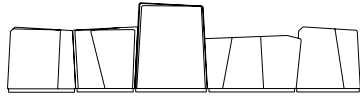
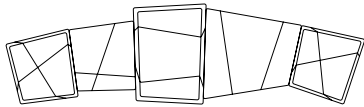

## Example E

### BENCHES

### TOTAL COM LIST PRICE

Flint (QF)

\$6057

Mica (QM)

Shale (QS)

Quartz (QQ)

Flint (QF)

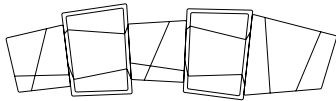

## Example F

### BENCHES

### TOTAL COM LIST PRICE

Mica (QM)

\$6172

Shale (QS)

Mica (QM)

Shale (QS)

Quartz (QQ)

Please note that example groups are provided as a specification tool. Example groups are shown from top and side profiles. Quarry benches must be ordered as separate line items for each unique model and/or finish specification.

### To specify:

Please refer to pages 3-4 for complete specifying information.

Specify all products by their product code.

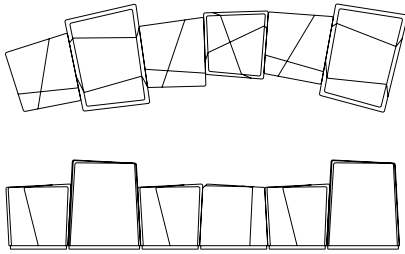

Example G	BENCHES	TOTAL COM LIST PRICE
	Mica (QM)	\$7221
	Shale (QS)	
	Mica (QM)	
	Flint (QF)	
	Mica (QM)	
	Shale (QS)	

Please note that example groups are provided as a specification tool. Example groups are shown from top and side profiles. Quarry benches must be ordered as separate line items for each unique model and/or finish specification.

**To specify:**  
 Please refer to pages 3-4 for complete specifying information.  
 Specify all products by their product code.



---

**5695 Eagle Drive, SE**  
**Grand Rapids,**  
**Michigan 49512**  
**616-975-9260**  
**[lelandfurniture.com](http://lelandfurniture.com)**

# Rapson Forty-Eight

## February 2022 Price List



# Rapson Forty-Eight Chair

Table of Contents	RP48-C2
Specification Information	RP48-C3
Specification Example	RP48-C4
Four Leg Steel Frame Side Chair	RP48-C5
Four Leg Maple Frame Side Chair	RP48-C7
Four Leg Steel Frame Counter Chair	RP48-C9
Four Leg Maple Frame Counter Chair	RP48-C11
Four Leg Steel Frame Bar Chair	RP48-C13
Four Leg Maple Frame Bar Chair	RP48-C15

# RAPSON FORTY-EIGHT CHAIR SPECIFICATION INFORMATION

# RP48-C3

## Chair Model

DESCRIPTION	CODE
Rapson Forty-Eight Four Leg Steel Frame Side Chair	RP48-SS
Rapson Forty-Eight Four Leg Maple Frame Side Chair	RP48-MS
Rapson Forty-Eight Four Leg Steel Frame Counter Chair	RP48-SC
Rapson Forty-Eight Four Leg Maple Frame Counter Chair	RP48-MC
Rapson Forty-Eight Four Leg Steel Frame Bar Chair	RP48-SB
Rapson Forty-Eight Four Leg Maple Frame Bar Chair	RP48-MB

## Shell Options

DESCRIPTION	CODE
Standard Shell	MP
Standard Shell with Upholstered Seat Pad	MPU
Standard HPL Shell	H
Standard HPL Shell with Upholstered Seat Pad	HU
Fully Upholstered	FU
Walnut Shell	W
Walnut Shell with Upholstered Seat Pad	WU
Premium HPL Shell	P
Premium HPL Shell with Upholstered Seat Pad	PU

## Shell Finishes

STANDARD HPL (HIGH PRESSURE LAMINATE)		PREMIUM HPL (HIGH PRESSURE LAMINATE)	
DESCRIPTION	CODE	DESCRIPTION	CODE
Fiji	FI	Blueberry Tart	BT
Brittany Blue	BB	Oxidized Silver	OS
Moss Grey	MG	Chili Powder	CP
Navaho Red	NR	Marmalade	MM
Fresh Papaya	FP	Copper Alloy	CA
Forsythia	FS		
Kool Kiwi	KK		
Honey Plantain	HP		
Spicy Flavors	SF		
Cafe Sienna	CS		
Designer White	WL		
Platinum	PL		

## VENEER

### STANDARD LELAND COLORS (On maple veneer shell only)

DESCRIPTION	CODE
Walnut	W
Maple	MP

## Frame Finish Options

### POWDERCOAT

(FOUR LEG STEEL TUBE)

DESCRIPTION	CODE	DESCRIPTION	CODE
Black	B	Cool Grey	CG
Sterling	ST	Matte Burnish	MBN
Warm Grey	WG	Matte Foundry	MFN
White	W	Matte Gold Rush	MGR
Black Textured	BT		

## Frame Finish Options (cont)

Matte Mercury	MMR	Grey Textured	GT
Matte Mineral	MMN	White Textured	WT

### TEXTURED POWDERCOAT

(FOUR LEG STEEL TUBE)

DESCRIPTION	CODE
Black	BT
Grey	GT
White	WT

### WOOD

(FOUR LEG WOOD FRAME, ON MAPLE)

DESCRIPTION	CODE
<b>LELAND COLORS</b> (Click to view)	

## Upholstery Option

Please refer to Leland Textile Program which features textiles and leathers from the following partners:

- Camira
- Green Hides
- Carnegie
- Maharam
- CF Stinson
- Unika Vaev

The complete grade list can be found at [lelandinternational.com/ecatalog](http://lelandinternational.com/ecatalog) or you can specify COM/COL. Due to the design of this product, it is recommended that all non pre-approved textile be tested for compatibility.

## Glide Option

DESCRIPTION	CODE
Nylon (standard)	S
Felt	FC
Floor Saver *only available on metal base	FS
Metal *only available on metal base	M
Rubber *only available on metal base	R

## Auxiliary Options

### PAINTED GRAPHIC BACK

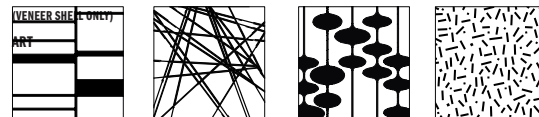

DESCRIPTION	CODE
Riff	RF
Improv	IM
Bebop	BB
Scat	SC

### PAINTED GRAPHIC COLOR OPTIONS

DESCRIPTION	CODE	DESCRIPTION	CODE
Oxford II	49M	Putty	44M
Dolphin II	50M	Oyster	45M

Only available on veneer shells finished in a clear finish (Natural Walnut 08, Natural Walnut 08M, Natural Maple 11, or Natural Maple 11M).

### SHELL HANDHOLD

DESCRIPTION	CODE
Handhold	HH

## Specifications required to create the product code

- Model
- Shell Selection
- Shell Finish/Color
- Upholstered Onlay Selection (when applicable)
- Frame Finish (or foot ring where applicable)
- Glide Type

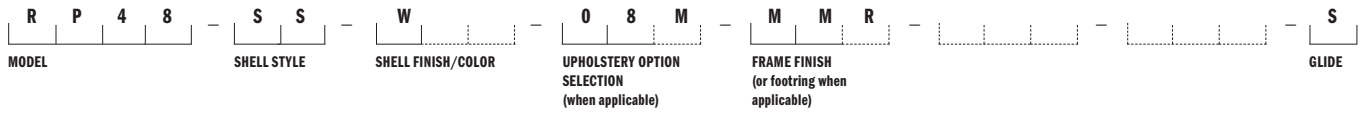

### MODEL

Rapson Forty-Eight Side Chair (RP48-SS)

### SHELL STYLE

Natural Maple (11)

### FRAME FINISH

Sterling (ST)

### UPHOLSTERY OPTION

Enter upholstery grade or COM  
(when applicable)

### GLIDE OPTION

Nylon (S)



RAPSON FORTY-EIGHT FOUR LEG STEEL FRAME  
SIDE CHAIR Design: Ralph Rapson

# RP48-C5



**Rapson Forty-Eight  
Steel Frame Side Chair**

	MODEL	LIST PRICE
Standard HPL Shell	RP48-SS-H	\$595
W 22 D 22.5 H 31.75 SH 18	Optional Glides: Add \$8.00 net per chair for a set of four (4)	



**Rapson Forty-Eight  
Steel Frame Side Chair**

	MODEL	COM/COL	A	B	C	D	E	F	G	H	I	J	K	L
Standard HPL Shell, upholstered seat pad	RP48-SS-HU	\$666	709	731	752	773	795	816	838	859	881	902	924	944
W 22 D 22.5 H 31.75 SH 18	COM Yardage: 1 or 2 chairs: 1 yard Contact Leland Customer Experience for yardage requirements on textiles with repeats. For COL requirements please contact Leland Customer Experience. Optional Glides: Add \$8.00 net per chair for a set of four (4)													



**Rapson Forty-Eight  
Steel Frame Side Chair**

	MODEL	COM/COL	A	B	C	D	E	F	G	H	I	J	K	L
Fully Upholstered	RP48-SS-FU	\$703	787	830	873	916	959	1002	1045	1087	1130	1173	1216	1259
W 22 D 22.5 H 31.75 SH 18	COM Yardage: 1.5 yards Contact Leland Customer Experience for yardage requirements on textiles with repeats. For COL requirements please contact Leland Customer Experience. Optional Glides: Add \$8.00 net per chair for a set of four (4)													



**Rapson Forty-Eight  
Steel Frame Side Chair**

	MODEL	LIST PRICE
Standard Shell	RP48-SS-MP	\$612
W 22 D 22.5 H 31.75 SH 18	Optional Glides: Add \$8.00 net per chair for a set of four (4)	



**Rapson Forty-Eight  
Steel Frame Side Chair**

	MODEL	COM/COL	A	B	C	D	E	F	G	H	I	J	K	L
Standard Shell, upholstered seat pad	RP48-SS-MPU	\$684	727	749	770	792	813	835	855	877	898	919	941	962
W 22 D 22.5 H 31.75 SH 18	COM Yardage: 1 or 2 chairs: 1 yard Contact Leland Customer Experience for yardage requirements on textiles with repeats. For COL requirements please contact Leland Customer Experience. Optional Glides: Add \$8.00 net per chair for a set of four (4)													

**To specify:  
Please refer to pages 3-4 for  
complete specifying information.  
Specify all products by their  
product code.**

RAPSON FORTY-EIGHT FOUR LEG STEEL FRAME  
SIDE CHAIR Design: Ralph Rapson

# RP48-C6



**Rapson Forty-Eight  
Steel Frame Side Chair**

	MODEL	LIST PRICE
Walnut Shell	RP48-SS-W	\$631
W 22 D 22.5 H 31.75 SH 18	Optional Glides: Add \$8.00 net per chair for a set of four (4)	



**Rapson Forty-Eight  
Steel Frame Side Chair**

	MODEL	COM/COL	A	B	C	D	E	F	G	H	I	J	K	L
Walnut Shell, upholstered seat pad	RP48-SS-WU	\$703	745	766	787	809	830	852	873	895	916	938	959	981
W 22 D 22.5 H 31.75 SH 18	COM Yardage: 1 or 2 chairs: 1 yard Contact Leland Customer Experience for yardage requirements on textiles with repeats. For COL requirements please contact Leland Customer Experience. Optional Glides: Add \$8.00 net per chair for a set of four (4)													



**Rapson Forty-Eight  
Steel Frame Side Chair**

	MODEL	LIST PRICE
Premium HPL Shell	RP48-SS-P	\$778
W 22 D 22.5 H 31.75 SH 18	Optional Glides: Add \$8.00 net per chair for a set of four (4)	



**Rapson Forty-Eight  
Steel Frame Side Chair**

	MODEL	COM/COL	A	B	C	D	E	F	G	H	I	J	K	L
Premium HPL Shell, upholstered seat pad	RP48-SS-PU	\$850	893	914	936	957	977	999	1020	1042	1063	1085	1106	1128
W 22 D 22.5 H 31.75 SH 18	COM Yardage: 1 or 2 chairs: 1 yard Contact Leland Customer Experience for yardage requirements on textiles with repeats. For COL requirements please contact Leland Customer Experience. Optional Glides: Add \$8.00 net per chair for a set of four (4)													

To specify:  
Please refer to pages 3-4 for complete specifying information.  
Specify all products by their product code.

Pricing Effective: February 2022

RAPSON FORTY-EIGHT MAPLE FRAME  
SIDE CHAIR Design: Ralph Rapson

# RP48-C7

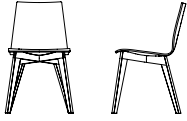

**Rapson Forty-Eight  
Maple Frame Side Chair**

	MODEL	LIST PRICE
Standard HPL Shell	RP48-MS-H	\$840
W 19.5 D 21.25 H 32 SH 18.25		Optional Glides: Add \$8.00 net per chair for a set of four (4)

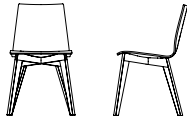

**Rapson Forty-Eight  
Maple Frame Side Chair**

	MODEL	COM/COL	A	B	C	D	E	F	G	H	I	J	K	L
Standard HPL Shell, upholstered seat pad	RP48-MS-HU	\$912	954	975	997	1018	1040	1061	1083	1104	1126	1147	1169	1190
W 19.5 D 21.25 H 32 SH 18.25		COM Yardage: 1 or 2 chairs: 1 yard Contact Leland Customer Experience for yardage requirements on textiles with repeats. For COL requirements please contact Leland Customer Experience. Optional Glides: Add \$8.00 net per chair for a set of four (4)												

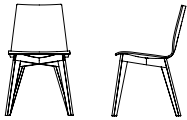

**Rapson Forty-Eight  
Maple Frame Side Chair**

	MODEL	COM/COL	A	B	C	D	E	F	G	H	I	J	K	L
Fully Upholstered	RP48-MS-FU	\$947	1032	1075	1118	1161	1204	1247	1290	1333	1376	1418	1461	1504
W 19.5 D 21.25 H 32 SH 18.25														

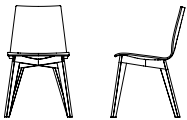

**Rapson Forty-Eight  
Maple Frame Side Chair**

	MODEL	LIST PRICE
Standard Shell	RP48-MS-MP	\$858
W 19.5 D 21.25 H 32 SH 18.25		Optional Glides: Add \$8.00 net per chair for a set of four (4)

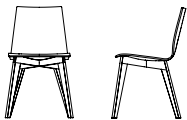

**Rapson Forty-Eight  
Maple Frame Side Chair**

	MODEL	COM/COL	A	B	C	D	E	F	G	H	I	J	K	L
Standard Shell, upholstered seat pad	RP48-MS-MPU	\$929	972	994	1015	1036	1058	1079	1101	1122	1144	1164	1186	1207
W 19.5 D 21.25 H 32 SH 18.25														

To specify:  
Please refer to pages 3-4 for complete specifying information.  
Specify all products by their product code.



RAPSON FORTY-EIGHT MAPLE FRAME  
SIDE CHAIR Design: Ralph Rapson

# RP48-C8

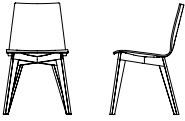

**Rapson Forty-Eight  
Maple Frame Side Chair**

	MODEL	LIST PRICE
Walnut Shell	RP48-MS-W	\$875
W 19.5 D 21.5 H 32 SH 18.25	Optional Glides: Add \$8.00 net per chair for a set of four (4)	

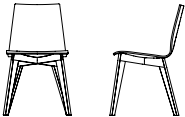

**Rapson Forty-Eight  
Maple Frame Side Chair**

	MODEL	COM/COL	A	B	C	D	E	F	G	H	I	J	K	L
Walnut Shell, upholstered seat pad	RP48-MS-WU	\$947	990	1012	1032	1054	1075	1097	1118	1140	1161	1183	1204	1225
W 19.5 D 21.5 H 32 SH 18.25	COM Yardage: 1 or 2 chairs: 1 yard Contact Leland Customer Experience for yardage requirements on textiles with repeats. For COL requirements please contact Leland Customer Experience. Optional Glides: Add \$8.00 net per chair for a set of four (4)													

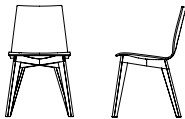

**Rapson Forty-Eight  
Maple Frame Side Chair**

	MODEL	LIST PRICE
Premium HPL Shell	RP48-MS-P	\$1024
W 19.5 D 21.5 H 32 SH 18.25	Optional Glides: Add \$8.00 net per chair for a set of four (4)	

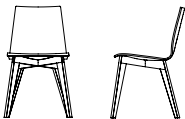

**Rapson Forty-Eight  
Maple Frame Side Chair**

	MODEL	COM/COL	A	B	C	D	E	F	G	H	I	J	K	L
Premium HPL Shell, Upholstered seat pad	RP48-MS-PU	\$1094	1137	1159	1180	1202	1223	1245	1266	1288	1308	1330	1351	1373
W 19.5 D 21.5 H 32 SH 18.25	COM Yardage: 1 or 2 chairs: 1 yard Contact Leland Customer Experience for yardage requirements on textiles with repeats. For COL requirements please contact Leland Customer Experience. Optional Glides: Add \$8.00 net per chair for a set of four (4)													

To specify:  
Please refer to pages 3-4 for complete specifying information.  
Specify all products by their product code.

Pricing Effective: February 2022

RAPSON FORTY-EIGHT FOUR LEG STEEL FRAME  
COUNTER CHAIR Design: Ralph Rapson

# RP48-C9

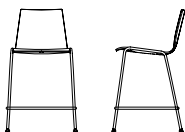

**Rapson Forty-Eight  
Steel Frame Counter Chair**

MODEL	LIST PRICE
Standard HPL Shell RP48-SC-H	\$841

W 19.75 D 20.75 H 32 SH 24

Optional Glides: Add \$8.00 net per chair for a set of four (4)

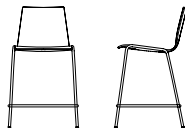

**Rapson Forty-Eight  
Steel Frame Counter Chair**

MODEL	COM/COL	A	B	C	D	E	F	G	H	I	J	K	L
Standard HPL Shell, upholstered seat pad RP48-SC-HU	\$913	955	976	998	1019	1041	1062	1084	1105	1127	1148	1170	1191

W 19.75 D 20.75 H 32 SH 24

COM Yardage: 1 or 2 chairs: 1 yard  
Contact Leland Customer Experience for yardage requirements on textiles with repeats.  
For COL requirements please contact Leland Customer Experience.  
Optional Glides: Add \$8.00 net per chair for a set of four (4)

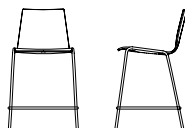

**Rapson Forty-Eight  
Steel Frame Counter Chair**

MODEL	COM/COL	A	B	C	D	E	F	G	H	I	J	K	L
Fully Upholstered RP48-SC-FU	\$948	1034	1076	1119	1162	1205	1248	1291	1334	1377	1419	1462	1505

W 19.75 D 20.75 H 32 SH 24

COM Yardage: 1.5 yards  
Contact Leland Customer Experience for yardage requirements on textiles with repeats.  
For COL requirements please contact Leland Customer Experience.  
Optional Glides: Add \$8.00 net per chair for a set of four (4)

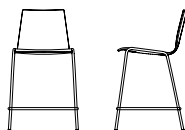

**Rapson Forty-Eight  
Steel Frame Counter Chair**

MODEL	LIST PRICE
Standard Shell RP48-SC-MP	\$859

W 19.75 D 20.75 H 32 SH 24

Optional Glides: Add \$8.00 net per chair for a set of four (4)

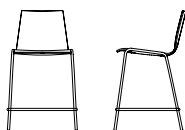

**Rapson Forty-Eight  
Steel Frame Counter Chair**

MODEL	COM/COL	A	B	C	D	E	F	G	H	I	J	K	L
Standard Shell, upholstered seat pad RP48-SC-MPU	\$930	973	995	1016	1038	1059	1081	1102	1123	1145	1165	1187	1208

W 19.75 D 20.75 H 32 SH 24

COM Yardage: 1 or 2 chairs: 1 yard  
Contact Leland Customer Experience for yardage requirements on textiles with repeats.  
For COL requirements please contact Leland Customer Experience.  
Optional Glides: Add \$8.00 net per chair for a set of four (4)

**To specify:  
Please refer to pages 3-4 for  
complete specifying information.  
Specify all products by their  
product code.**

RAPSON FORTY-EIGHT FOUR LEG STEEL FRAME  
COUNTER CHAIR Design: Ralph Rapson

# RP48-C10

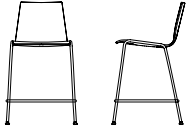

**Rapson Forty-Eight  
Steel Frame Counter Chair**

	MODEL	LIST PRICE
Walnut Shell	RP48-SC-W	\$877
W 19.75 D 20.75 H 32 SH 24		Optional Glides: Add \$8.00 net per chair for a set of four (4)

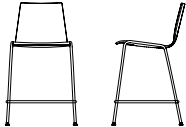

**Rapson Forty-Eight  
Steel Frame Counter Chair**

	MODEL	COM/COL	A	B	C	D	E	F	G	H	I	J	K	L
Walnut Shell, upholstered seat pad	RP48-SC-WU	\$948	991	1013	1034	1056	1076	1098	1119	1141	1162	1184	1205	1227
W 19.75 D 20.75 H 32 SH 24		COM Yardage: 1 or 2 chairs: 1 yard Contact Leland Customer Experience for yardage requirements on textiles with repeats. For COL requirements please contact Leland Customer Experience. Optional Glides: Add \$8.00 net per chair for a set of four (4)												

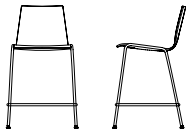

**Rapson Forty-Eight  
Steel Frame Counter Chair**

	MODEL	LIST PRICE
Premium HPL Shell	RP48-SC-P	\$1025
W 19.75 D 20.75 H 32 SH 24		Optional Glides: Add \$8.00 net per chair for a set of four (4)

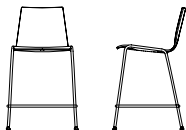

**Rapson Forty-Eight  
Steel Frame Counter Chair**

	MODEL	COM/COL	A	B	C	D	E	F	G	H	I	J	K	L
Premium HPL Shell, Upholstered seat pad	RP48-SC-PU	\$1096	1134	1156	1176	1198	1219	1241	1262	1283	1305	1326	1348	1369
W 19.75 D 20.75 H 32 SH 24		COM Yardage: 1 or 2 chairs: 1 yard Contact Leland Customer Experience for yardage requirements on textiles with repeats. For COL requirements please contact Leland Customer Experience. Optional Glides: Add \$8.00 net per chair for a set of four (4)												

To specify:  
Please refer to pages 3-4 for  
complete specifying information.  
Specify all products by their  
product code.

Pricing Effective: February 2022

RAPSON FORTY-EIGHT MAPLE FRAME  
COUNTER CHAIR Design: Ralph Rapson

# RP48-C11

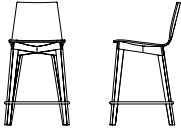

**Rapson Forty-Eight  
Maple Frame Counter Chair**

	MODEL	LIST PRICE
Standard HPL Shell	RP48-MC-H	\$1332

W 18.5 D 20 H 35 SH 24

Optional Glides: Add \$8.00 net per chair for a set of four (4)

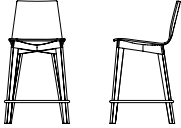

**Rapson Forty-Eight  
Maple Frame Counter Chair**

	MODEL	COM/COL	A	B	C	D	E	F	G	H	I	J	K	L
Standard HPL Shell, upholstered seat pad	RP48-MC-HU	\$1403	1446	1467	1488	1510	1531	1553	1573	1595	1616	1638	1659	1681

W 18.5 D 20 H 35 SH 24

COM Yardage: 1 or 2 chairs: 1 yard  
Contact Leland Customer Experience for yardage requirements on textiles with repeats.  
For COL requirements please contact Leland Customer Experience.  
Optional Glides: Add \$8.00 net per chair for a set of four (4)

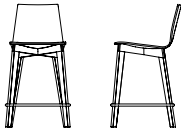

**Rapson Forty-Eight  
Maple Frame Counter Chair**

	MODEL	COM/COL	A	B	C	D	E	F	G	H	I	J	K	L
Fully Upholstered	RP48-MC-FU	\$1438	1524	1567	1610	1653	1695	1738	1781	1823	1866	1909	1952	1995

W 18.5 D 20 H 35 SH 24

COM Yardage: 1.5 yards  
Contact Leland Customer Experience for yardage requirements on textiles with repeats.  
For COL requirements please contact Leland Customer Experience.  
Optional Glides: Add \$8.00 net per chair for a set of four (4)

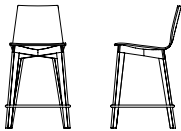

**Rapson Forty-Eight  
Maple Frame Counter Chair**

	MODEL	LIST PRICE
Standard Shell	RP48-MC-MP	\$1349

W 18.5 D 20 H 35 SH 24

Optional Glides: Add \$8.00 net per chair for a set of four (4)

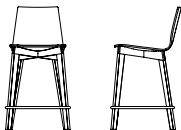

**Rapson Forty-Eight  
Maple Frame Counter Chair**

	MODEL	COM/COL	A	B	C	D	E	F	G	H	I	J	K	L
Standard Shell, upholstered seat pad	RP48-MC-MPU	\$1421	1463	1484	1506	1527	1549	1570	1592	1613	1634	1656	1677	1699

W 18.5 D 20 H 35 SH 24

COM Yardage: 1 or 2 chairs: 1 yard  
Contact Leland Customer Experience for yardage requirements on textiles with repeats.  
For COL requirements please contact Leland Customer Experience.  
Optional Glides: Add \$8.00 net per chair for a set of four (4)

**To specify:  
Please refer to pages 3-4 for  
complete specifying information.  
Specify all products by their  
product code.**

RAPSON FORTY-EIGHT MAPLE FRAME  
COUNTER CHAIR Design: Ralph Rapson

# RP48-C12

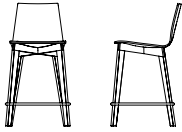

**Rapson Forty-Eight  
Maple Frame Counter Chair**

	MODEL	LIST PRICE
Walnut Shell	RP48-MC-W	\$1490
W 18.5 D 20 H 35 SH 24	Optional Glides: Add \$8.00 net per chair for a set of four (4)	

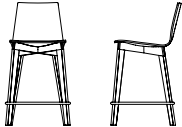

**Rapson Forty-Eight  
Maple Frame Counter Chair**

	MODEL	COM/COL	A	B	C	D	E	F	G	H	I	J	K	L
Walnut Shell, upholstered seat pad	RP48-MC-WU	\$1560	1603	1625	1646	1668	1689	1711	1732	1754	1775	1797	1818	1838
W 18.5 D 20 H 35 SH 24	COM Yardage: 1 or 2 chairs: 1 yard Contact Leland Customer Experience for yardage requirements on textiles with repeats. For COL requirements please contact Leland Customer Experience. Optional Glides: Add \$8.00 net per chair for a set of four (4)													

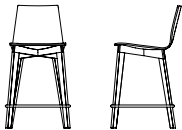

**Rapson Forty-Eight  
Maple Frame Counter Chair**

	MODEL	LIST PRICE
Premium HPL Shell	RP48-MC-P	\$1637
W 18.5 D 20 H 35 SH 24	Optional Glides: Add \$8.00 net per chair for a set of four (4)	

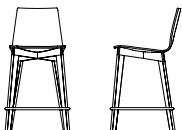

**Rapson Forty-Eight  
Maple Frame Counter Chair**

	MODEL	COM/COL	A	B	C	D	E	F	G	H	I	J	K	L
Premium HPL Shell, Upholstered seat pad	RP48-MC-PU	\$1709	1750	1772	1793	1815	1836	1858	1879	1901	1922	1944	1965	1987
W 18.5 D 20 H 35 SH 24	COM Yardage: 1 or 2 chairs: 1 yard Contact Leland Customer Experience for yardage requirements on textiles with repeats. For COL requirements please contact Leland Customer Experience. Optional Glides: Add \$8.00 net per chair for a set of four (4)													

To specify:  
Please refer to pages 3-4 for complete specifying information.  
Specify all products by their product code.

Pricing Effective: February 2022

RAPSON FORTY-EIGHT FOUR LEG STEEL FRAME  
BAR CHAIR Design: Ralph Rapson

# RP48-C13



**Rapson Forty-Eight  
Steel Frame Bar Chair**

	MODEL	LIST PRICE
Standard HPL Shell	RP48-SB-H	\$855
W 20 D 23 H 41 SH 30		Optional Glides: Add \$8.00 net per chair for a set of four (4)



**Rapson Forty-Eight  
Steel Frame Bar Chair**

	MODEL	COM/COL	A	B	C	D	E	F	G	H	I	J	K	L
Standard HPL Shell, upholstered seat pad	RP48-SB-HU	\$927	970	991	1013	1034	1056	1076	1098	1119	1141	1162	1184	1205
W 20 D 23 H 41 SH 30		COM Yardage: 1 or 2 chairs: 1 yard Contact Leland Customer Experience for yardage requirements on textiles with repeats. For COL requirements please contact Leland Customer Experience. Optional Glides: Add \$8.00 net per chair for a set of four (4)												



**Rapson Forty-Eight  
Steel Frame Bar Chair**

	MODEL	COM/COL	A	B	C	D	E	F	G	H	I	J	K	L
Fully Upholstered	RP48-SB-FU	\$962	1048	1091	1134	1176	1219	1262	1305	1348	1391	1434	1477	1520
W 20 D 23 H 41 SH 30		COM Yardage: 1.5 yards Contact Leland Customer Experience for yardage requirements on textiles with repeats. For COL requirements please contact Leland Customer Experience. Optional Glides: Add \$8.00 net per chair for a set of four (4)												



**Rapson Forty-Eight  
Steel Frame Bar Chair**

	MODEL	LIST PRICE
Standard Shell	RP48-SB-MP	\$873
W 20 D 23 H 41 SH 30		Optional Glides: Add \$8.00 net per chair for a set of four (4)

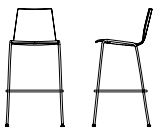

**Rapson Forty-Eight  
Steel Frame Bar Chair**

	MODEL	COM/COL	A	B	C	D	E	F	G	H	I	J	K	L
Standard Shell, upholstered seat pad	RP48-SB-MPU	\$944	987	1009	1030	1052	1073	1094	1116	1137	1159	1180	1202	1223
W 20 D 23 H 41 SH 30		COM Yardage: 1 or 2 chairs: 1 yard Contact Leland Customer Experience for yardage requirements on textiles with repeats. For COL requirements please contact Leland Customer Experience. Optional Glides: Add \$8.00 net per chair for a set of four (4)												

**To specify:  
Please refer to pages 3-4 for  
complete specifying information.  
Specify all products by their  
product code.**

RAPSON FORTY-EIGHT FOUR LEG STEEL FRAME  
BAR CHAIR Design: Ralph Rapson

# RP48-C14

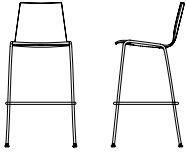

**Rapson Forty-Eight  
Steel Frame Bar Chair**

	MODEL	LIST PRICE
Walnut Shell	RP48-SB-W	\$893
W 20 D 23 H 41 SH 30	Optional Glides: Add \$8.00 net per chair for a set of four (4)	

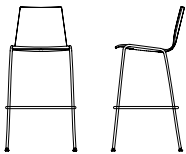

**Rapson Forty-Eight  
Steel Frame Bar Chair**

	MODEL	COM/COL	A	B	C	D	E	F	G	H	I	J	K	L
Walnut Shell, upholstered seat pad	RP48-SB-WU	\$964	1006	1028	1049	1071	1092	1114	1135	1157	1178	1200	1220	1242
W 20 D 23 H 41 SH 30	COM Yardage: 1 or 2 chairs: 1 yard Contact Leland Customer Experience for yardage requirements on textiles with repeats. For COL requirements please contact Leland Customer Experience. Optional Glides: Add \$8.00 net per chair for a set of four (4)													

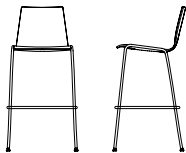

**Rapson Forty-Eight  
Steel Frame Bar Chair**

	MODEL	LIST PRICE
Premium HPL Shell	RP48-SB-P	\$1039
W 20 D 23 H 41 SH 30	Optional Glides: Add \$8.00 net per chair for a set of four (4)	

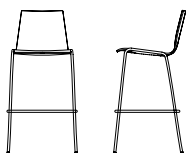

**Rapson Forty-Eight  
Steel Frame Bar Chair**

	MODEL	COM/COL	A	B	C	D	E	F	G	H	I	J	K	L
Premium HPL Shell, Upholstered seat pad	RP48-SB-PU	\$998	1148	1170	1191	1213	1234	1255	1277	1297	1319	1340	1362	1383
W 20 D 23 H 41 SH 30	COM Yardage: 1 or 2 chairs: 1 yard Contact Leland Customer Experience for yardage requirements on textiles with repeats. For COL requirements please contact Leland Customer Experience. Optional Glides: Add \$8.00 net per chair for a set of four (4)													

**To specify:**  
 Please refer to pages 3-4 for  
 complete specifying information.  
 Specify all products by their  
 product code.

**Pricing Effective: February 2022**

RAPSON FORTY-EIGHT MAPLE FRAME  
BAR CHAIR Design: Ralph Rapson

# RP48-C15



**Rapson Forty-Eight  
Maple Frame Bar Chair**

	MODEL	LIST PRICE
Standard HPL Shell	RP48-MB-H	\$1590
W 19.5 D 20.5 H 41 SH 30		Optional Glides: Add \$8.00 net per chair for a set of four (4)



**Rapson Forty-Eight  
Maple Frame Bar Chair**

	MODEL	COM/COL	A	B	C	D	E	F	G	H	I	J	K	L
Standard HPL Shell, upholstered seat pad	RP48-MB-HU	\$1661	1704	1726	1747	1769	1790	1812	1833	1855	1876	1897	1919	1940
W 19.5 D 20.5 H 41 SH 30		COM Yardage: 1 or 2 chairs: 1 yard Contact Leland Customer Experience for yardage requirements on textiles with repeats. For COL requirements please contact Leland Customer Experience. Optional Glides: Add \$8.00 net per chair for a set of four (4)												



**Rapson Forty-Eight  
Maple Frame Bar Chair**

	MODEL	COM/COL	A	B	C	D	E	F	G	H	I	J	K	L
Fully Upholstered	RP48-MB-FU	\$1698	1783	1826	1869	1911	1954	1997	2040	2083	2125	2168	2211	2254
W 19.5 D 20.5 H 41 SH 30		COM Yardage: 1.5 yards Contact Leland Customer Experience for yardage requirements on textiles with repeats. For COL requirements please contact Leland Customer Experience. Optional Glides: Add \$8.00 net per chair for a set of four (4)												



**Rapson Forty-Eight  
Maple Frame Bar Chair**

	MODEL	LIST PRICE
Standard Shell	RP48-MB-MP	\$1609
W 19.5 D 20.5 H 41 SH 30		Optional Glides: Add \$8.00 net per chair for a set of four (4)



**Rapson Forty-Eight  
Maple Frame Bar Chair**

	MODEL	COM/COL	A	B	C	D	E	F	G	H	I	J	K	L
Standard Shell, upholstered seat pad	RP48-SB-MPU	\$1680	1723	1744	1765	1787	1808	1830	1851	1872	1893	1915	1936	1958
W 19.5 D 20.5 H 41 SH 30		COM Yardage: 1 or 2 chairs: 1 yard Contact Leland Customer Experience for yardage requirements on textiles with repeats. For COL requirements please contact Leland Customer Experience. Optional Glides: Add \$8.00 net per chair for a set of four (4)												

**To specify:**  
Please refer to pages 3-4 for complete specifying information.  
Specify all products by their product code.



RAPSON FORTY-EIGHT FOUR MAPLE FRAME  
BAR CHAIR Design: Ralph Rapson

# RP48-C16



**Rapson Forty-Eight  
Maple Frame Bar Chair**

	MODEL	LIST PRICE
Walnut Shell	RP48-MB-W	\$1749
W 19.5 D 20.5 H 41 SH 30	Optional Glides: Add \$8.00 net per chair for a set of four (4)	



**Rapson Forty-Eight  
Maple Frame Bar Chair**

	MODEL	COM/COL	A	B	C	D	E	F	G	H	I	J	K	L
Walnut Shell, upholstered seat pad	RP48-MB-WU	\$1821	1864	1886	1907	1929	1949	1971	1992	2013	2035	2056	2078	2099
W 19.5 D 20.5 H 41 SH 30	COM Yardage: 1 or 2 chairs: 1 yard Contact Leland Customer Experience for yardage requirements on textiles with repeats. For COL requirements please contact Leland Customer Experience. Optional Glides: Add \$8.00 net per chair for a set of four (4)													



**Rapson Forty-Eight  
Maple Frame Bar Chair**

	MODEL	LIST PRICE
Premium HPL Shell	RP48-MB-P	\$1896
W 19.5 D 20.5 H 41 SH 30	Optional Glides: Add \$8.00 net per chair for a set of four (4)	



**Rapson Forty-Eight  
Maple Frame Bar Chair**

	MODEL	COM/COL	A	B	C	D	E	F	G	H	I	J	K	L
Premium HPL Shell, Upholstered seat pad	RP48-MB-PU	\$1967	2010	2032	2053	2075	2096	2118	2139	2161	2181	2202	2224	2245
W 19.5 D 20.5 H 41 SH 30	COM Yardage: 1 or 2 chairs: 1 yard Contact Leland Customer Experience for yardage requirements on textiles with repeats. For COL requirements please contact Leland Customer Experience. Optional Glides: Add \$8.00 net per chair for a set of four (4)													

**To specify:**  
 Please refer to pages 3-4 for complete specifying information.  
 Specify all products by their product code.

<b>Painted Back</b>	<b>MODEL</b>	<b>LIST PRICE</b>
	Reference color codes on page RP48-C3	\$185

<b>Handhold</b>	<b>MODEL</b>	<b>LIST PRICE</b>
	HH	\$32

To specify:  
Please refer to pages 3-4 for  
complete specifying information.  
Specify all products by their  
product code.

---

**5695 Eagle Drive, SE**  
**Grand Rapids,**  
**Michigan 49512**  
**616-975-9260**  
**[lelandfurniture.com](http://lelandfurniture.com)**

# Rapson Thirty-Nine

February 2022 Price List

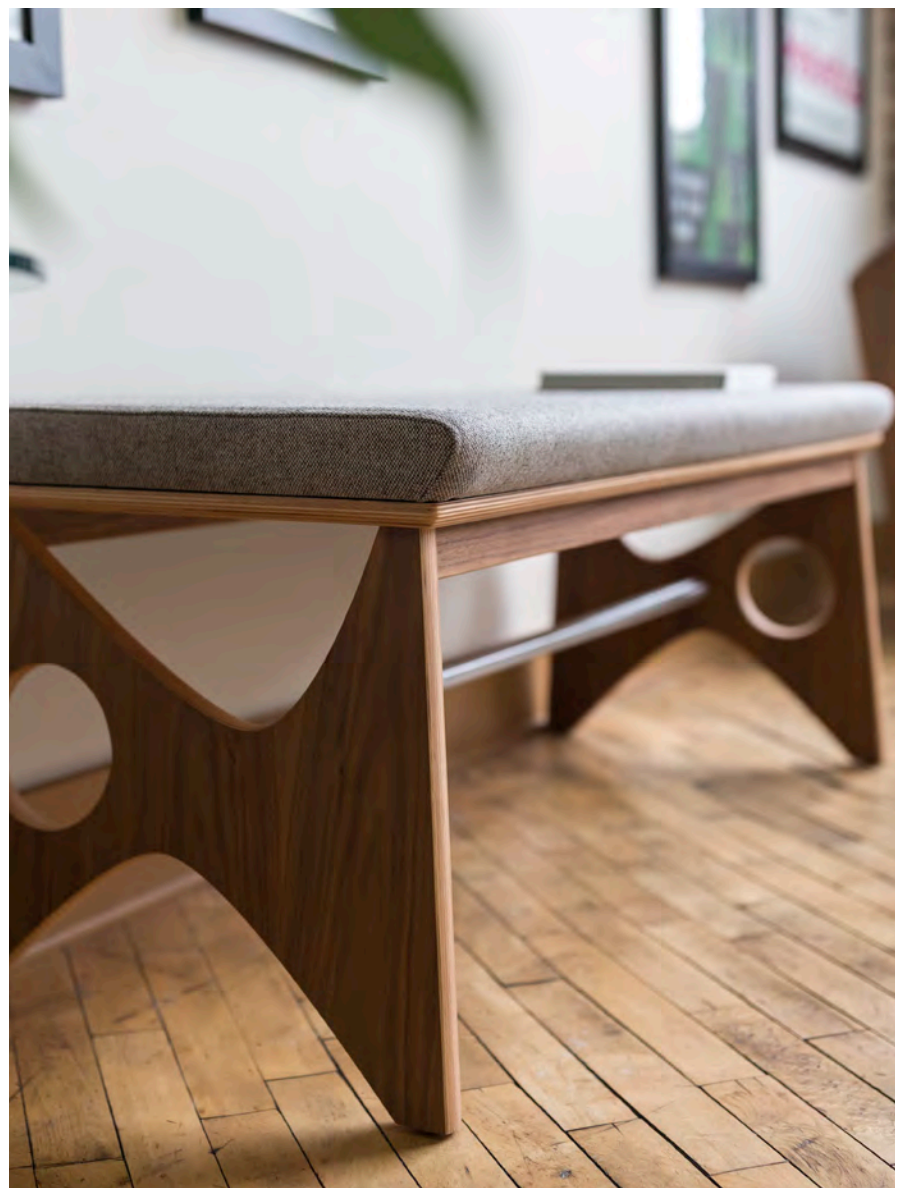

# Rapson Thirty-Nine Bench

Table of Contents	RP39-BN2
Specification Information	RP39-BN3
Specification Example	RP39-BN4
Rapson Thirty-Nine Bench 20"	RP39-BN5
Rapson Thirty-Nine Bench 48"	RP39-BN5

## Bench Model

---

DESCRIPTION	CODE
Rapson Thirty-Nine Bench	RP39-BN

## Bench Width

---

DESCRIPTION	CODE
20"	20
48"	48

## Bench Frame and Button Finish Options

---

DESCRIPTION	CODE
Natural Walnut	08M
Natural Ash	07M

## Upholstery Selection

---

Please refer to Leland Textile Program which features textiles and leathers from the following partners:

- Camira
- Green Hides
- Carnegie
- Maharam
- CF Stinson
- Unika Vaev

The complete grade list can be found at [lelandinternational.com/ecatalog](http://lelandinternational.com/ecatalog) or you can specify COM/COL. Due to the design of this product, it is recommended that all non pre-approved textile be tested for compatibility.

## Glide Option

---

DESCRIPTION	CODE
Nylon (standard)	S
Felt	F

## Specifications required to create the product code

- Model
- Bench Width
- Bench Frame and Button Finish Selection
- Upholstery Selection
- Glide Option

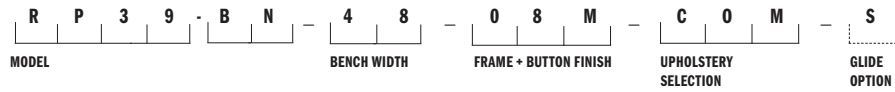

### MODEL

Rapson Thirty-Nine Bench (RP39-BN)

### BENCH WIDTH

48" (48)

### BENCH FRAME + BUTTON FINISH

Natural Walnut (08M)

### UPHOLSTERY SELECTION

Enter upholstery grade or COM

### GLIDE OPTION

Nylon (S)



RAPSON THIRTY-NINE BENCH  
Design: Ralph Rapson

# RP39-BN5

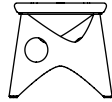
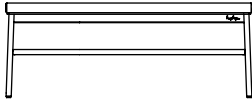

Rapson Thirty-Nine	MODEL	COM/COL	A	B	C	D	E	F	G	H	I	J	K	L
48" Bench	RP39-BN-48	\$2121	2208	2252	2296	2339	2383	2427	2470	2513	2557	2600	2644	2688

W 48.5 D 19.25 H 18.5

COM Yardage: 1.5 yards  
Contact Leland Customer Experience for yardage requirements on textiles with repeats.  
For COL requirements please contact Leland Customer Experience.

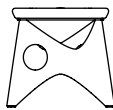

Rapson Thirty-Nine	MODEL	COM/COL	A	B	C	D	E	F	G	H	I	J	K	L
20" Bench	RP39-BN-20	\$1327	1356	1371	1385	1400	1415	1429	1443	1457	1472	1486	1501	1515

W 19.5 D 19.25 H 18.5

COM Yardage: 1.5 yards  
Contact Leland Customer Experience for yardage requirements on textiles with repeats.  
For COL requirements please contact Leland Customer Experience.

To specify:  
Please refer to pages 3-4 for complete specifying information.  
Specify all products by their product code.

Pricing Effective: February 2022



---

**5695 Eagle Drive, SE**  
**Grand Rapids,**  
**Michigan 49512**  
**616-975-9260**  
**[lelandfurniture.com](http://lelandfurniture.com)**

# Rapson Thirty-Nine Guest

## February 2022 Price List



# Rapson Thirty-Nine Guest

Table of Contents	RP39-G2
Specification Information	RP39-G3
Specification Example	RP39-G4
Guest Chair	RP39-G5

## Chair Model

---

DESCRIPTION	CODE
Rapson Thirty-Nine Guest Chair	RP39-G

## Frame Finish Options

---

DESCRIPTION	CODE
Natural Walnut	08M
Natural Ash	07M

## Fully Upholstered or Onlay Selection

---

Please refer to Leland Textile Program which features textiles and leathers from the following partners:

- Camira
- Carnegie
- CF Stinson
- Green Hides
- Maharam
- Unika Vaev

The complete grade list can be found at [www.lelandfurniture.com/ecatalog](http://www.lelandfurniture.com/ecatalog) or you can specify COM/COL. Due to the design of this product, it is recommended that all non pre-approved textile be tested for compatibility.

## Optional Contrasted Upper Back Upholstery

---

Please refer to Leland Textile Program which features textiles and leathers from the following partners:

- Camira
- Carnegie
- CF Stinson
- Green Hides
- Maharam
- Unika Vaev

The complete grade list can be found at [www.lelandfurniture.com/ecatalog](http://www.lelandfurniture.com/ecatalog) or you can specify COM/COL. Due to the design of this product, it is recommended that all non pre-approved textile be tested for compatibility.

## Glide Option

---

DESCRIPTION	CODE
Nylon (standard)	S
Felt	F

## Specifications required to create the product code

- Model
- Frame Finish Selection
- Upholstery Selection
- Optional Upper Back Upholstery
- Glide Option

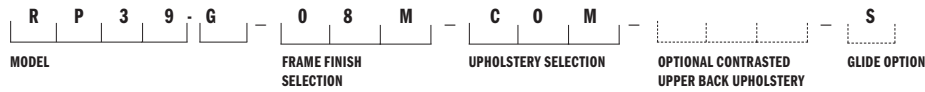

### MODEL

Rapson Thirty-Nine Guest (RP39-G)

### FRAME FINISH

Natural Walnut (08M)

### UPHOLSTERY SELECTION

Enter upholstery grade or COM

### GLIDE OPTION

Nylon (S)



RAPSON THIRTY-NINE GUEST  
 Design: Ralph Rapson

# RP39-G5

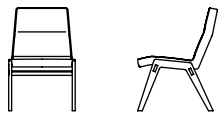

**Rapson Thirty-Nine**

	MODEL	COM/COL	A	B	C	D	E	F	G	H	I	J	K	L
Guest Chair	RP39-G	\$2522	2609	2653	2697	2741	2784	2828	2871	2914	2958	3002	3045	3089

W 22 D 27 H 35 SH 18.5

COM Yardage: 1 seat: 2.75 yards  
 Contact Leland Customer Experience for yardage requirements on textiles with repeats.  
 Optional Glides: Add \$8.00 net per chair for a set of four (4).

To specify:  
 Please refer to pages 3-4 for complete specifying information.  
 Specify all products by their product code.

Pricing Effective: February 2022

---

**5695 Eagle Drive, SE**  
**Grand Rapids,**  
**Michigan 49512**  
**616-975-9260**  
**[lelandfurniture.com](http://lelandfurniture.com)**

# Rapson Thirty-Nine Lounge

February 2022 Price List





# Rapson Thirty-Nine Lounge

Table of Contents	RP39-L2
Specification Information	RP39-L3
Specification Example	RP39-L4
Rapson Thirty-Nine Lounge	RP39-L5

## Chair Model

---

DESCRIPTION	CODE
Rapson Thirty-Nine Lounge Chair	RP39-L

## Frame Finish Options

---

DESCRIPTION	CODE
Natural Walnut	08M
Natural Ash	07M

## Fully Upholstered or Onlay Selection

---

Please refer to Leland Textile Program which features textiles and leathers from the following partners:

- Camira
- Carnegie
- CF Stinson
- Green Hides
- Maharam
- Unika Vaev

The complete grade list can be found at [www.lelandfurniture.com/ecatalog](http://www.lelandfurniture.com/ecatalog) or you can specify COM/COL. Due to the design of this product, it is recommended that all non pre-approved textile be tested for compatibility.

## Glide Option

---

DESCRIPTION	CODE
Nylon (standard)	S
Felt	F

## Specifications required to create the product code

- Model
- Frame Finish Selection
- Upholstery Selection
- Glide Option

**R** **P** **3** **9** **-** **L** - **0** **8** **M** - **C** **O** **M** - **S**  
MODEL FRAME FINISH UPHOLSTERY SELECTION GLIDE OPTION

### MODEL

Rapson Thirty-Nine Lounge (RP39-L)

### FRAME FINISH

Natural Walnut (08M)

### UPHOLSTERY SELECTION

Enter upholstery grade or COM

### GLIDE OPTION

Nylon (S)



RAPSON THIRTY-NINE LOUNGE  
 Design: Ralph Rapson

# RP39-L5

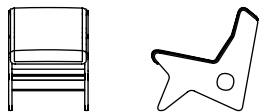

**Rapson Thirty-Nine**

	MODEL	COM/COL	A	B	C	D	E	F	G	H	I	J	K	L
Lounge Chair	RP39-L	\$2988	3090	3142	3192	3244	3294	3345	3396	3447	3498	3549	3599	3651

W 24 D 32.25 H 31 SH 18.25

COM Yardage: 1 seat: 1.75 yards  
 Contact Leland Customer Experience for yardage requirements on textiles with repeats.  
 Optional Glides: Add \$8.00 net per chair for a set of four (4).

To specify:  
 Please refer to pages 3-4 for complete specifying information.  
 Specify all products by their product code.

Pricing Effective: February 2022

---

**5695 Eagle Drive, SE**  
**Grand Rapids,**  
**Michigan 49512**  
**616-975-9260**  
**[lelandfurniture.com](http://lelandfurniture.com)**

# Slam

## February 2022 Price List



**SLAM LOUNGE CHAIR**  
 Design: Lievore Altherr Molina, licensed by Sellex

**SL27**



**Slam Lounge  
 Sled Base**

	MODEL	LIST PRICE/GRADE	COM/COL	A	B	C	D	E	F	G	H	I	J	K	L
Fully upholstered	SLL-S	Powder Coat	\$1082	1170	1218	1268	1316	1364	1412	1461	1509	1559	1607	1656	1704
W 27.5 D 27.5 H 30 SH 17		Chrome	\$1152	1239	1287	1337	1386	1434	1482	1530	1579	1628	1676	1724	1773

Optional Glides: Add \$8.00 net per chair for a set of four (4). Optional Glides raise chair height .5 inch.  
 COM Yardage: 1 seat: 1.75 yard  
 Contact Leland Customer Experience for yardage requirements on textiles with repeats.  
 For COL requirements please contact Leland Customer Experience.



**Slam Lounge  
 Pyramidal Base**

	MODEL	LIST PRICE/GRADE	COM/COL	A	B	C	D	E	F	G	H	I	J	K	L
Fully upholstered	SLL-P	Powder Coat	\$1571	1659	1707	1756	1805	1853	1901	1950	1998	2046	2094	2145	2193
W 27.5 D 26 H 30 SH 17		Polished Aluminun	\$2168	2256	2304	2353	2401	2449	2497	2547	2595	2643	2691	2740	2788

Optional Glides: Add \$8.00 net per chair for a set of four (4). Optional Glides raise chair height .5 inch.  
 COM Yardage: 1 seat: 1.75 yard  
 Contact Leland Customer Experience for yardage requirements on textiles with repeats.  
 For COL requirements please contact Leland Customer Experience.

**To specify:**  
 Please refer to pages 3-4 for complete specifying information.  
 Specify all products by their product code.

# Slam

Table of Contents	SL2
Specification Information	SL3
Specification Example	SL4
Sled Base	SL5
Stacking Four-Leg Base	SL7
Wood Leg Chair	SL9
Stacking Four-Leg Mobile Base	SL10
Side Chair, Aluminum Base	SL12
Arm Chair, Aluminum Base	SL14
Task Base	SL16
Sled Counter Chair	SL18
Four-Leg Counter Chair	SL20
Sled Bar Chair	SL22
Four-Leg Bar Chair	SL24
Stacking/Transport Dolly	SL26
Slam Lounge	SL27



**Chair Model**

DESCRIPTION	CODE
SLAM sled base	SLS
SLAM stacking 4-leg base	SL4
SLAM stacking 4-leg mobile base	SLM
SLAM side chair, aluminum base	SLA
SLAM arm chair, aluminum base	SLAA
SLAM task base	SLTB
SLAM side chair, wood leg	SLW
SLAM sled, counter chair	SLCS
SLAM 4-leg, counter chair	SLC4
SLAM sled, bar chair	SLBS
SLAM 4-leg, bar chair	SLB4

**Shell Selection**

DESCRIPTION	CODE
Polypropylene	PO
Polypropylene with Upholstered Seat Onlay	PU
Fully Upholstered	FU
3D Beech Veneer	3DB
3D Beech Veneer with Upholstered Seat Onlay	3BU
3D Oak Veneer	3DO
3D Oak Veneer with Upholstered Seat Onlay	3OU

**Shell Finish/Color****POLYPROPYLENE SHELL:**

DESCRIPTION	CODE	DESCRIPTION	CODE
White	WT	Grey	G
Black	BK	Arctic	AR
Caribbean	CB	Soda Red	SR
Ink	IN	Dolphin	DL
Limelight	LL	Oxford	OX
Tangerine	TN	Ice Blue	IB

**CUSTOM POLYPROPYLENE COLORS**

Custom color match is available upon request. Please contact hello@lelandinternational.com for further information

**BEECH 3D VENEER SHELL:**

DESCRIPTION	CODE
Natural Beech	09

**STANDARD LELAND COLORS****OAK 3D VENEER SHELL:**

DESCRIPTION	ODE
Natural White Oak	12

**Fully Upholstered or Onlay Selection**

Please refer to Leland Textile Program which features textiles and leathers from the following partners:

- Camira
- Green Hides
- Carnegie
- Maharam
- CF Stinson
- Unika Vaev

The complete grade list can be found at [www.lelandfurniture.com/ecatalog](http://www.lelandfurniture.com/ecatalog) or you can specify COM/COL. Due to the design of this product, it is recommended that all non pre-approved textile be tested for compatibility.

**Pricing Effective: February 2022**

**Frame Finish**

DESCRIPTION	CODE
Textured Frame Finish	
White Textured Powder Coat	WT
Black Textured Powder Coat	BT
Grey Textured Powder Coat	GT
Soda Red Textured	SRT
Dolphin Textured	DLT
Oxford Textured	OXT
Tangerine Textured	TNT
Ice Blue Textured	IBT
Arctic Textured	ART
Caribbean Textured	CBT
Limelight Textured	LLT
Ink Textured	INT
Warm Grey	WG
Cool Grey	CG
Black	B
White	W
Matte Gold Rush	MGR
Matte Mercury	MMR
Matte Mineral	MMN
Matte Burnish	MBN
Matte Foundry	MFN
Sterling	ST
Chrome	C
Polished Aluminum (Aluminum models only)	P

Wood Leg Finish

**LELAND COLORS****Glide or Caster Type****STANDARD GLIDES:**

DESCRIPTION	CODE
Poly (Sled base)	S
Nylon (4-Leg, Aluminum base)	S
Rubber (Slam Wood Leg)	S

**OPTIONAL GLIDES:**

DESCRIPTION	CODE
Felt	FC
Floor Saver™ (for VCT type floors) (4-Leg base only)	FS
Metal (4-Leg base only)	M
Rubber (4-Leg base or Aluminum Base only)	R

\*Please note that optional glides for four leg models raise the chair height .5 inch.

**CASTER TYPE:**

(for 4-leg mobile and task base)

DESCRIPTION	CODE
Hard Floor Caster	HF
Soft Floor Caster	SF

(Slam Task Base comes with universal hard and soft floor casters)

**Stacking note**

SLAM side chair, 4 leg base and 4 leg mobile base in Polypropylene or Veneer shells are the only versions recommended for stacking. Stacking any other version could result in frame or shell damage.

**Specifications required to create the product code**

- Model
- Shell Selection
- Shell Finish
- Upholstered Onlay Selection (when applicable)
- Frame Finish
- Glide or Caster Type

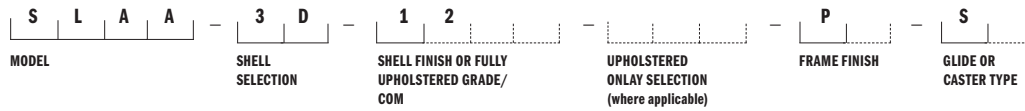

**MODEL**

Slam arm chair, aluminum base (SLAA)

**SHELL SELECTION**

3D Veneer (3D)

**SHELL FINISH**

Natural White Oak (12)

**UPHOLSTERED ONLAY SELECTION**

When applicable, enter upholstery grade, COM



**FRAME FINISH**

Polished Aluminum (P)

**GLIDE OR CASTER TYPE**

Standard Nylon (S)



**SLAM SLED BASE CHAIR**  
 Design: Lievore Altherr Molina, licensed by Sellex

**SL5**



<b>Slam Sled Base Chair</b>	<b>MODEL</b>	<b>FRAME FINISH</b>	<b>LIST PRICE</b>
Polypropylene shell	SLS-PO	Powder Coat	\$444
W 22.5 D 20.75 H 31.75 SH 18		Chrome	\$507



<b>Slam Sled Base Chair</b>	<b>MODEL</b>	<b>LIST PRICE/GRADE</b>	<b>COM/COL</b>	<b>A</b>	<b>B</b>	<b>C</b>	<b>D</b>	<b>E</b>	<b>F</b>	<b>G</b>	<b>H</b>	<b>I</b>	<b>J</b>	<b>K</b>	<b>L</b>
Polypropylene shell, upholstered seat onlay	SLS-PU	Powder Coat	\$583	648	682	715	748	782	816	849	883	916	949	983	1016
		Chrome	\$646	712	745	778	812	845	880	913	946	980	1013	1046	1080
W 22.5 D 20.75 H 31.75 SH 18.25		COM Yardage: 1 or 2 seats: .75 yard Contact Leland Customer Experience for yardage requirements on textiles with repeats. For COL requirements please contact Leland Customer Experience.													



<b>Slam Sled Base Chair</b>	<b>MODEL</b>	<b>LIST PRICE/GRADE</b>	<b>COM/COL</b>	<b>A</b>	<b>B</b>	<b>C</b>	<b>D</b>	<b>E</b>	<b>F</b>	<b>G</b>	<b>H</b>	<b>I</b>	<b>J</b>	<b>K</b>	<b>L</b>
Fully upholstered	SLS-FU	Powder Coat	\$720	836	894	952	1010	1068	1126	1185	1243	1301	1360	1418	1476
		Chrome	\$787	903	962	1020	1078	1137	1195	1253	1311	1370	1427	1485	1543
W 22.5 D 20.75 H 31.75 SH 18.25		COM Yardage: 1 seat: 1.5 yards Contact Leland Customer Experience for yardage requirements on textiles with repeats. For COL requirements please contact Leland Customer Experience.													

**To specify:**  
 Please refer to pages 3-4 for complete specifying information.  
 Specify all products by their product code.

**SLAM SLED BASE CHAIR**  
 Design: Lievore Altherr Molina, licensed by Sellex

**SL6**



Slam Sled Base Chair	MODEL	FRAME FINISH	LIST PRICE
3D Beech veneer shell	SLS-3DB	Powder Coat	\$1032
W 22.5 D 20.75 H 31.75 SH 18		Chrome	\$1173



Slam Sled Base Chair	MODEL	LIST PRICE/ GRADE	COM/COL	A	B	C	D	E	F	G	H	I	J	K	L
3D Beech veneer shell, upholstered seat onlay	SLS-3BU	Powder Coat	\$1173	1239	1272	1307	1340	1373	1407	1440	1473	1507	1540	1575	1608
		Chrome	\$1237	1302	1337	1370	1404	1437	1470	1504	1537	1570	1604	1638	1671
W 22.5 D 20.75 H 31.75 SH 18.25		COM Yardage: 1 or 2 seats: .75 yard Contact Leland Customer Experience for yardage requirements on textiles with repeats. Optional Glides: Add \$8.00 net per chair for a set of four (4).													



Slam Sled Base Chair	MODEL	FRAME FINISH	LIST PRICE
3D Oak veneer shell	SLS-3D0	Powder Coat	\$1195
W 22.5 D 20.75 H 31.75 SH 18		Chrome	\$1261



Slam Sled Base Chair	MODEL	LIST PRICE/ GRADE	COM/COL	A	B	C	D	E	F	G	H	I	J	K	L
3D Oak veneer shell, upholstered seat onlay	SLS-30U	Powder Coat	\$1337	1402	1436	1469	1503	1536	1569	1603	1636	1670	1704	1737	1770
		Chrome	\$1399	1466	1499	1533	1566	1599	1633	1666	1699	1734	1767	1801	1834
W 22.5 D 20.75 H 31.75 SH 18.25		COM Yardage: 1 or 2 seats: .75 yard Contact Leland Customer Experience for yardage requirements on textiles with repeats. Optional Glides: Add \$8.00 net per chair for a set of four (4).													

**To specify:**  
 Please refer to pages 3-4 for complete specifying information.  
 Specify all products by their product code.

**Pricing Effective: February 2022**

**SLAM 4-LEG BASE CHAIR**  
 Design: Lievore Altherr Molina, licensed by Sellex

**SL7**



**Slam Stacking  
 4-Leg Base Chair**

	MODEL	FRAME FINISH	LIST PRICE
Polypropylene shell	SL4-PO	Powder Coat	\$460
W 20.75 D 19.75 H 31 SH 18		Chrome	\$525

Optional Glides: Add \$8.00 net per chair for a set of four (4). Optional Glides raise chair height .5 inch.



**Slam 4-Leg Base Chair**

	MODEL	LIST PRICE/GRADE	COM/COL	A	B	C	D	E	F	G	H	I	J	K	L
Polypropylene shell, upholstered seat onlay	SL4-PU	Powder Coat	\$600	665	699	732	766	800	833	867	900	933	967	1000	1033
		Chrome	\$665	731	764	798	832	866	899	932	966	999	1032	1066	1100

Optional Glides: Add \$8.00 net per chair for a set of four (4). Optional Glides raise chair height .5 inch.

COM Yardage: 1 or 2 seats: .75 yard

Contact Leland Customer Experience for yardage requirements on textiles with repeats.

For COL requirements please contact Leland Customer Experience.



**Slam 4-Leg Base Chair**

	MODEL	LIST PRICE/GRADE	COM/COL	A	B	C	D	E	F	G	H	I	J	K	L
Polypropylene shell, upholstered seat onlay, stacking	SL4-PUS	Powder Coat	\$626	691	725	758	792	826	859	893	926	959	993	1026	1059
		Chrome	\$691	757	790	824	858	892	925	958	992	1025	1058	1092	1126

Optional Glides: Add \$8.00 net per chair for a set of four (4). Optional Glides raise chair height .5 inch.

COM Yardage: 1 seat: .75 yard

Contact Leland Customer Experience for yardage requirements on textiles with repeats.

For COL requirements please contact Leland Customer Experience.



**Slam 4-Leg Base Chair**

	MODEL	LIST PRICE/GRADE	COM/COL	A	B	C	D	E	F	G	H	I	J	K	L
Fully upholstered	SL4-FU	Powder Coat	\$739	855	914	972	1030	1088	1147	1204	1262	1320	1379	1437	1495
		Chrome	\$807	924	981	1039	1097	1156	1214	1272	1330	1389	1447	1505	1564

Optional Glides: Add \$8.00 net per chair for a set of four (4). Optional Glides raise chair height .5 inch.

COM Yardage: 1 seat: 1.5 yards

Contact Leland Customer Experience for yardage requirements on textiles with repeats.

For COL requirements please contact Leland Customer Experience.

**To specify:**

**Please refer to pages 3-4 for  
 complete specifying information.**

**Specify all products by their  
 product code.**

**SLAM 4-LEG BASE CHAIR**  
 Design: Lievore Altherr Molina, licensed by Sellex

**SL8**



**Slam Stacking  
 4-Leg Base Chair**

	MODEL	FRAME FINISH	LIST PRICE
3D Beech veneer shell W 20.75 D 19.75 H 31 SH 18	SL4-3DB	Powder Coat	\$1050
		Chrome	\$1116

Optional Glides: Add \$8.00 net per chair for a set of four (4). Optional Glides raise chair height .5 inch.



**Slam 4-Leg Base Chair**

	MODEL	LIST PRICE/ GRADE	COM/COL	A	B	C	D	E	F	G	H	I	J	K	L
				3D Beech veneer shell, upholstered seat onlay	SL4-3BU	Powder Coat	\$1189	1255	1288	1323	1356	1390	1423	1456	1490
		Chrome	\$1256	1323	1356	1390	1423	1456	1490	1523	1556	1591	1624	1657	1691

W 20.75 D 19.75 H 31 SH 18.25

Optional Glides: Add \$8.00 net per chair for a set of four (4). Optional Glides raise chair height .5 inch.  
 COM Yardage: 1 or 2 seats: .75 yard  
 Contact Leland Customer Experience for yardage requirements on textiles with repeats.  
 For COL requirements please contact Leland Customer Experience.



**Slam Stacking  
 4-Leg Base Chair**

	MODEL	FRAME FINISH	LIST PRICE
3D Oak veneer shell W 20.75 D 19.75 H 31 SH 18	SL4-3D0	Powder Coat	\$1214
		Chrome	\$1278

Optional Glides: Add \$8.00 net per chair for a set of four (4). Optional Glides raise chair height .5 inch.



**Slam Stacking  
 4-Leg Base Chair**

	MODEL	LIST PRICE/ GRADE	COM/COL	A	B	C	D	E	F	G	H	I	J	K	L
				3D Oak veneer shell, upholstered seat onlay	SL4-30U	Powder Coat	\$1353	1419	1452	1485	1519	1552	1585	1619	1652
		Chrome	\$1420	1485	1519	1552	1585	1619	1652	1686	1720	1753	1787	1820	1853

W 20.75 D 19.75 H 31 SH 18.25

Optional Glides: Add \$8.00 net per chair for a set of four (4). Optional Glides raise chair height .5 inch.  
 COM Yardage: 1 or 2 seats: .75 yard  
 Contact Leland Customer Experience for yardage requirements on textiles with repeats.  
 For COL requirements please contact Leland Customer Experience.

**To specify:**  
 Please refer to pages 3-4 for complete specifying information.  
 Specify all products by their product code.

**SLAM SIDE CHAIR, WOOD LEG**  
 Design: Lievore Altherr Molina, licensed by Sellex

**SL9**



<b>Slam Side Chair, Wood Leg</b>	<b>MODEL</b>	<b>LIST PRICE</b>
Polypropylene shell, Beech Wood Leg W 22.5 D 21.5 H 31 SH 18	SLW-PO	\$728



<b>Slam Side Chair, Wood Leg</b>	<b>MODEL</b>	<b>COM/COL</b>	<b>A</b>	<b>B</b>	<b>C</b>	<b>D</b>	<b>E</b>	<b>F</b>	<b>G</b>	<b>H</b>	<b>I</b>	<b>J</b>	<b>K</b>	<b>L</b>
Polypropylene shell, Beech Leg upholstered seat onlay W 22.5 D 21.5 H 31 SH 18.25	SLW-PU	\$868	933	967	1000	1033	1068	1101	1135	1168	1201	1235	1268	1301

COM Yardage: 1 or 2 seats: .75 yard  
 Contact Leland Customer Experience for yardage requirements on textiles with repeats.  
 For COL requirements please contact Leland Customer Experience.



<b>Slam Side Chair, Wood Leg</b>	<b>MODEL</b>	<b>COM/COL</b>	<b>A</b>	<b>B</b>	<b>C</b>	<b>D</b>	<b>E</b>	<b>F</b>	<b>G</b>	<b>H</b>	<b>I</b>	<b>J</b>	<b>K</b>	<b>L</b>
Fully upholstered, Beech Leg W 22.5 D 21.5 H 31 SH 18.25	SLW-FU	\$1019	1135	1194	1252	1310	1367	1426	1484	1542	1601	1659	1717	1775

COM Yardage: 1 seat: 1.5 yards  
 Contact Leland Customer Experience for yardage requirements on textiles with repeats.  
 For COL requirements please contact Leland Customer Experience.

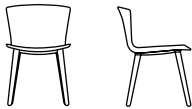

<b>Slam Side Chair, Wood Leg</b>	<b>MODEL</b>	<b>LIST PRICE</b>
3D Beech veneer shell, Beech Leg W 22.5 D 21.5 H 31 SH 18	SLW-3DB	\$1355



<b>Slam Side Chair, Wood Leg</b>	<b>MODEL</b>	<b>COM/COL</b>	<b>A</b>	<b>B</b>	<b>C</b>	<b>D</b>	<b>E</b>	<b>F</b>	<b>G</b>	<b>H</b>	<b>I</b>	<b>J</b>	<b>K</b>	<b>L</b>
3D Beech veneer shell, Beech Leg upholstered seat onlay W 22.5 D 21.5 H 31 SH 18.25	SLW-3BU	\$1533	1598	1632	1665	1698	1733	1766	1799	1833	1866	1900	1933	1966

COM Yardage: 1 or 2 seats: .75 yard  
 Contact Leland Customer Experience for yardage requirements on textiles with repeats.  
 For COL requirements please contact Leland Customer Experience.

**To specify:**  
 Please refer to pages 3-4 for complete specifying information.  
 Specify all products by their product code.

**SLAM 4-LEG MOBILE BASE CHAIR**  
 Design: Lievore Altherr Molina, licensed by Sellex

**SL10**



**Slam Stacking**

**4-Leg Mobile Base Chair**

	MODEL	FRAME FINISH	LIST PRICE
Polypropylene shell w/ casters	SLM-PO	Powder Coat	\$727
W 20.75 D 19.75 H 31 .75 SH 18.25		Chrome	\$790



**Slam**

**4-Leg Mobile Base Chair**

	MODEL	LIST PRICE/ GRADE	COM/COL	A	B	C	D	E	F	G	H	I	J	K	L
Polypropylene shell, upholstered seat onlay, w/ casters	SLM-PU	Powder Coat	\$869	934	968	1001	1035	1069	1102	1136	1169	1202	1236	1269	1302
		Chrome	\$930	996	1029	1062	1096	1129	1164	1197	1230	1264	1297	1330	1364

COM Yardage: 1 or 2 seats: .75 yard  
 Contact Leland Customer Experience for yardage requirements on textiles with repeats.  
 For COL requirements please contact Leland Customer Experience.



**Slam**

**4-Leg Mobile Base Chair**

	MODEL	LIST PRICE/ GRADE	COM/COL	A	B	C	D	E	F	G	H	I	J	K	L
Polypropylene shell, upholstered seat onlay, w/ casters, stacking	SLM-PUS	Powder Coat	\$895	960	994	1027	1061	1095	1128	1162	1195	1228	1262	1295	1328
		Chrome	\$956	1022	1055	1088	1122	1155	1190	1223	1256	1290	1323	1356	1390

COM Yardage: 1 or 2 seats: .75 yard  
 Contact Leland Customer Experience for yardage requirements on textiles with repeats.  
 For COL requirements please contact Leland Customer Experience.



**Slam**

**4-Leg Mobile Base Chair**

	MODEL	LIST PRICE/ GRADE	COM/COL	A	B	C	D	E	F	G	H	I	J	K	L
Fully upholstered w/ casters	SLM-FU	Powder Coat	\$1021	1138	1196	1254	1313	1371	1429	1486	1545	1603	1661	1719	1778
W 20.75 D 19.75 H 31 .75 SH 18.5		Chrome	\$1085	1202	1260	1318	1376	1435	1493	1551	1610	1668	1725	1783	1842

COM Yardage: 1 seat: 1.5 yards  
 Contact Leland Customer Experience for yardage requirements on textiles with repeats.  
 For COL requirements please contact Leland Customer Experience.

To specify:

Please refer to pages 3-4 for complete specifying information.  
 Specify all products by their product code.



**SLAM 4-LEG MOBILE BASE CHAIR**  
 Design: Lievore Altherr Molina, licensed by Sellex

**SL11**



**Slam Stacking**

4-Leg Mobile Base Chair	MODEL	FRAME FINISH	LIST PRICE
3D Beech veneer shell w/ casters	SLM-3DB	Powder Coat	\$1317
		Chrome	\$1382
W 20.75 D 19.75 H 31.75 SH 18.25			



**Slam**

4-Leg Mobile Base Chair	MODEL	LIST PRICE/ GRADE	COM/COL	A	B	C	D	E	F	G	H	I	J	K	L
3D Beech veneer shell, upholstered seat onlay, w/ casters	SLM-3BU	Powder Coat	\$1458	1524	1557	1592	1625	1659	1692	1725	1759	1792	1825	1860	1893
		Chrome	\$1522	1588	1622	1655	1689	1722	1755	1789	1822	1855	1889	1923	1957
W 20.75 D 19.75 H 31.75 SH 18.5				COM Yardage: 1 or 2 seats: .75 yard Contact Leland Customer Experience for yardage requirements on textiles with repeats. For COL requirements please contact Leland Customer Experience.											



**Slam Stacking**

4-Leg Mobile Base Chair	MODEL	FRAME FINISH	LIST PRICE
3D Oak veneer shell w/ casters	SLM-3DO	Powder Coat	\$1481
		Chrome	\$1546
W 20.75 D 19.75 H 31.75 SH 18.25			



**Slam**

4-Leg Mobile Base Chair	MODEL	LIST PRICE/ GRADE	COM/COL	A	B	C	D	E	F	G	H	I	J	K	L
3D Beech veneer shell, upholstered seat onlay, w/ casters	SLM-3OU	Powder Coat	\$1622	1688	1721	1754	1788	1821	1854	1888	1922	1955	1989	2022	2056
		Chrome	\$1686	1752	1785	1819	1852	1886	1919	1952	1987	2020	2053	2087	2120
W 20.75 D 19.75 H 31.75 SH 18.5				CCOM Yardage: 1 or 2 seats: .75 yard Contact Leland Customer Experience for yardage requirements on textiles with repeats. For COL requirements please contact Leland Customer Experience.											

**To specify:**

**Please refer to pages 3-4 for complete specifying information. Specify all products by their product code.**

**SLAM SIDE CHAIR, ALUMINUM BASE**  
 Design: Lievore Altherr Molina, licensed by Sellex

**SL12**



**Slam Side Chair**

**Aluminum Base**

	MODEL	FRAME FINISH	LIST PRICE
Polypropylene shell	SLA-PO	Powder Coat	\$748
W 20.75 D 20.75 H 31.75 SH 18		Polished Aluminum	\$1316



**Slam Side Chair**

**Aluminum Base**

	MODEL	LIST PRICE/GRADE	COM/COL	A	B	C	D	E	F	G	H	I	J	K	L
Polypropylene shell upholstered seat onlay	SLA-PU	Powder Coat	\$889	955	989	1023	1056	1089	1123	1156	1189	1223	1256	1291	1324
		Polished Aluminum	\$1457	1523	1556	1591	1624	1657	1691	1724	1758	1791	1824	1859	1892
W 20.75 D 20.75 H 31.75 SH 18.25			COM Yardage: 1 or 2 seats: .75 yard Contact Leland Customer Experience for yardage requirements on textiles with repeats.												



**Slam Side Chair**

**Aluminum Base**

	MODEL	LIST PRICE/GRADE	COM/COL	A	B	C	D	E	F	G	H	I	J	K	L
Fully upholstered	SLA-FU	Powder Coat	\$1042	1158	1216	1274	1333	1391	1449	1508	1566	1624	1682	1740	1798
W 20.75 D 20.75 H 31.75 SH 18.25		Polished Aluminum	\$1638	1753	1811	1870	1928	1986	2044	2103	2161	2219	2278	2335	2393
			COM Yardage: 1 seat: 1.5 yards Contact Leland Customer Experience for yardage requirements on textiles with repeats.												

**To specify:**

Please refer to pages 3-4 for complete specifying information.  
 Specify all products by their product code.

**SLAM SIDE CHAIR, ALUMINUM BASE**  
 Design: Lievore Altherr Molina, licensed by Sellex

**SL13**



**Slam Side Chair**

**Aluminum Base**

	MODEL	FRAME FINISH	LIST PRICE
3D Beech veneer shell, aluminum base	SLA-3DB	Powder Coat	\$1341
		Polished Aluminum	\$1907

W 20.75 D 20.75  
H 31.75 SH 18



**Slam Side Chair**

**Aluminum Base**

	MODEL	LIST PRICE/GRADE	COM/COL	A	B	C	D	E	F	G	H	I	J	K	L
3D Beech veneer shell, upholstered seat onlay, aluminum base	SLA-3BU	Powder Coat	\$1480	1546	1579	1612	1646	1679	1712	1746	1780	1813	1847	1880	1914
		Polished Aluminum	\$2047	2114	2147	2180	2214	2247	2280	2314	2347	2382	2415	2448	2482

W 20.75 D 20.75  
H 31.75 SH 18.25

Optional Glides: Add \$8.00 net per chair for a set of four (4). Optional Glides raise chair height .5 inch.  
 COM Yardage: 1 or 2 seats: .75 yard  
 Contact Leland Customer Experience for yardage requirements on textiles with repeats.



**Slam Side Chair**

**Aluminum Base**

	MODEL	FRAME FINISH	LIST PRICE
3D Oak veneer shell, aluminum base	SLA-3DO	Powder Coat	\$1504
		Polished Aluminum	\$2070

W 20.75 D 20.75  
H 31.75 SH 18



**Slam Side Chair**

**Aluminum Base**

	MODEL	LIST PRICE/GRADE	COM/COL	A	B	C	D	E	F	G	H	I	J	K	L
3D Oak veneer shell, upholstered seat onlay, aluminum base	SLA-3OU	Powder Coat	\$1642	1708	1741	1775	1808	1841	1876	1909	1943	1976	2009	2043	2076
		Polished Aluminum	\$2210	2276	2309	2343	2376	2410	2444	2477	2511	2544	2577	2611	2644

W 20.75 D 20.75  
H 31.75 SH 18.25

Optional Glides: Add \$8.00 net per chair for a set of four (4). Optional Glides raise chair height .5 inch.  
 COM Yardage: 1 or 2 seats: .75 yard  
 Contact Leland Customer Experience for yardage requirements on textiles with repeats.

**To specify:**

**Please refer to pages 3-4 for complete specifying information. Specify all products by their product code.**

**SLAM ARM CHAIR, ALUMINUM BASE**  
 Design: Lievore Altherr Molina, licensed by Sellex

**SL14**



**Slam Arm Chair**

**Aluminum Base**

	MODEL	FRAME FINISH	LIST PRICE
Polypropylene shell	SLAA-PO	Powder Coat	\$837
W 25 D 20.75 H 31.75 SH 18 AH 25.5		Polished Aluminum	\$1454



**Slam Arm Chair**

**Aluminum Base**

	MODEL	LIST PRICE/GRADE	COM/COL	A	B	C	D	E	F	G	H	I	J	K	L
Polypropylene shell upholstered seat onlay	SLAA-PU	Powder Coat	\$977	1043	1076	1110	1143	1177	1211	1244	1278	1311	1344	1378	1411
		Polished Aluminum	\$1592	1657	1691	1724	1758	1791	1824	1859	1892	1925	1959	1992	2025

W 25 D 20.75 H 31.75  
SH 18.25 AH 25.5

COM Yardage: 1 or 2 seats: .75 yard  
 Contact Leland Customer Experience for yardage requirements on textiles with repeats.



**Slam Arm Chair**

**Aluminum Base**

	MODEL	LIST PRICE/GRADE	COM/COL	A	B	C	D	E	F	G	H	I	J	K	L
Fully upholstered	SLAA-FU	Powder Coat	\$1134	1251	1308	1366	1425	1483	1541	1599	1658	1716	1774	1833	1891
		Polished Aluminum	\$1781	1898	1956	2014	2072	2131	2189	2247	2305	2363	2421	2479	2538

W 25 D 20.75 H 31.75  
SH 18.25 AH 25.5

COM Yardage: 1.5 yards  
 Contact Leland Customer Experience for yardage requirements on textiles with repeats.

**To specify:**  
 Please refer to pages 3-4 for complete specifying information.  
 Specify all products by their product code.

**SLAM ARM CHAIR, ALUMINUM BASE**  
 Design: Lievore Altherr Molina, licensed by Sellex

**SL15**



**Slam Arm Chair**

<b>Aluminum Base</b>	<b>MODEL</b>	<b>FRAME FINISH</b>	<b>LIST PRICE</b>
3D Beech veneer shell	SLAA-3DB	Powder Coat	\$1427
W 25 D 20.75 H 31.75 SH 18 AH 25.5		Polished Aluminum	\$2043



**Slam Arm Chair**

<b>Aluminum Base</b>	<b>MODEL</b>	<b>LIST PRICE/GRADE</b>	<b>COM/COL</b>	<b>A</b>	<b>B</b>	<b>C</b>	<b>D</b>	<b>E</b>	<b>F</b>	<b>G</b>	<b>H</b>	<b>I</b>	<b>J</b>	<b>K</b>	<b>L</b>
3D Beech veneer shell, upholstered seat onlay, aluminum base	SLAA-3BU	Powder Coat	\$1567	1633	1666	1699	1734	1767	1801	1834	1867	1901	1934	1967	2002
		Polished Aluminum	\$2183	2248	2282	2315	2349	2383	2416	2449	2483	2516	2549	2583	2616
W 25 D 20.75 H 31.75 SH 18.25 AH 25.5		Optional Glides: Add \$8.00 net per chair for a set of four (4). Optional Glides raise chair height .5 inch. COM Yardage: 1 or 2 seats: .75 yard Contact Leland Customer Experience for yardage requirements on textiles with repeats.													



**Slam Arm Chair**

<b>Aluminum Base</b>	<b>MODEL</b>	<b>FRAME FINISH</b>	<b>LIST PRICE</b>
3D Oak veneer shell, aluminum base	SLAA-3DO	Powder Coat	\$1591
W 25 D 20.75 H 31.75 SH 18 AH 25.5		Polished Aluminum	\$2204



**Slam Arm Chair**

<b>Aluminum Base</b>	<b>MODEL</b>	<b>LIST PRICE/GRADE</b>	<b>COM/COL</b>	<b>A</b>	<b>B</b>	<b>C</b>	<b>D</b>	<b>E</b>	<b>F</b>	<b>G</b>	<b>H</b>	<b>I</b>	<b>J</b>	<b>K</b>	<b>L</b>
3D Oak veneer shell, upholstered seat onlay, aluminum base	SLAA-3OU	Powder Coat	\$1730	1796	1830	1863	1896	1930	1963	1996	2030	2063	2098	2131	2164
		Polished Aluminum	\$2345	2411	2445	2478	2512	2545	2578	2612	2645	2679	2713	2746	2780
W 25 D 20.75 H 31.75 SH 18.25 AH 25.5		Optional Glides: Add \$8.00 net per chair for a set of four (4). Optional Glides raise chair height .5 inch. COM Yardage: 1 or 2 seats: .75 yard Contact Leland Customer Experience for yardage requirements on textiles with repeats.													

**To specify:**

Please refer to pages 3-4 for complete specifying information.  
 Specify all products by their product code.

**SLAM TASK BASE CHAIR**  
 Design: Lievore Altherr Molina, licensed by Sellex

**SL16**

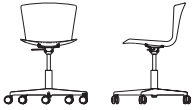

<b>Slam Task Base Chair</b>	<b>MODEL</b>	<b>FRAME FINISH</b>	<b>LIST PRICE</b>
Polypropylene shell	SLTB-PO	Powder Coat	\$843
W 20.75 D 20.75 H 31.75 SH 18.25		Task Base comes with universal hard and soft floor casters.	



<b>Slam Task Base Chair</b>	<b>MODEL</b>	<b>LIST PRICE/GRADE</b>	<b>COM/COL</b>	<b>A</b>	<b>B</b>	<b>C</b>	<b>D</b>	<b>E</b>	<b>F</b>	<b>G</b>	<b>H</b>	<b>I</b>	<b>J</b>	<b>K</b>	<b>L</b>
Polypropylene shell, upholstered seat onlay	SLTB-PU	Powder Coat	\$982	1024	1044	1065	1086	1107	1127	1149	1169	1189	1211	1231	1252
W 20.75 D 20.75 H 31.75 SH 18.5		COM Yardage: 1 or 2 seats: .75 yard Contact Leland Customer Experience for yardage requirements on textiles with repeats. Task Base comes with universal hard and soft floor casters.													

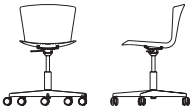

<b>Slam Task Base Chair</b>	<b>MODEL</b>	<b>LIST PRICE/GRADE</b>	<b>COM/COL</b>	<b>A</b>	<b>B</b>	<b>C</b>	<b>D</b>	<b>E</b>	<b>F</b>	<b>G</b>	<b>H</b>	<b>I</b>	<b>J</b>	<b>K</b>	<b>L</b>
Fully upholstered	SLTB-FU	Powder Coat	\$1140	1257	1315	1373	1431	1490	1547	1605	1663	1722	1780	1838	1897
W 20.75 D 20.75 H 31.75 SH 18.5		COM Yardage: 1 seat: 1.5 yards Contact Leland Customer Experience for yardage requirements on textiles with repeats. Task Base comes with universal hard and soft floor casters.													

**To specify:**  
 Please refer to pages 3-4 for complete specifying information.  
 Specify all products by their product code.

**SLAM TASK BASE CHAIR**  
 Design: Lievore Altherr Molina, licensed by Sellex

**SL17**

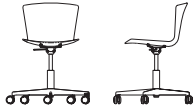

Slam Task Base Chair	MODEL	FRAME FINISH	LIST PRICE
3D Beech veneer shell	SLTB-3DB	Powder Coat	\$1433
W 20.75 D 20.75 H 31.75 SH 18.25		Task Base comes with universal hard and soft floor casters.	



Slam Task Base Chair	MODEL	LIST PRICE/GRADE	COM/COL	A	B	C	D	E	F	G	H	I	J	K	L
3D Beech veneer shell, upholstered seat onlay	SLTB-3BU	Powder Coat	\$1575	1616	1636	1657	1678	1698	1720	1740	1761	1782	1803	1823	1845
W 20.75 D 20.75 H 31.75 SH 18.5		COM Yardage: 1 or 2 seats: .75 yard Contact Leland Customer Experience for yardage requirements on textiles with repeats. Task Base comes with universal hard and soft floor casters.													



Slam Task Base Chair	MODEL	FRAME FINISH	LIST PRICE
3D Oak veneer shell	SLTB-3DO	Powder Coat	\$1595
W 20.75 D 20.75 H 31.75 SH 18.25		Task Base comes with universal hard and soft floor casters.	

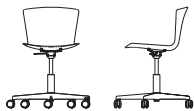

Slam Task Base Chair	MODEL	LIST PRICE/GRADE	COM/COL	A	B	C	D	E	F	G	H	I	J	K	L
3D Oak veneer shell, upholstered seat onlay	SLTB-3OU	Powder Coat	\$1737	1778	1799	1820	1840	1862	1882	1903	1924	1945	1965	1987	2007
W 20.75 D 20.75 H 31.75 SH 18.5		COM Yardage: 1 or 2 seats: .75 yard Contact Leland Customer Experience for yardage requirements on textiles with repeats. Task Base comes with universal hard and soft floor casters.													

**To specify:**  
 Please refer to pages 3-4 for complete specifying information.  
 Specify all products by their product code.

**SLAM SLED COUNTER CHAIR**  
 Design: Lievore Altherr Molina, licensed by Sellex

**SL18**



**Slam Sled  
 Counter Chair**

	MODEL	FRAME FINISH	LIST PRICE
Polypropylene shell	SLCS-PO	Powder Coat	\$673
W 22 D 20.75 H 39 SH 25		Chrome	\$748

Optional Glides: Add \$8.00 net per chair for a set of four (4).



**Slam Sled  
 Counter Chair**

	MODEL	LIST PRICE/GRADE	COM/COL	A	B	C	D	E	F	G	H	I	J	K	L
Polypropylene shell, upholstered seat onlay,	SLCS-PU	Powder Coat	\$815	881	914	947	981	1014	1047	1081	1114	1149	1182	1215	1249
		Chrome	\$889	955	989	1023	1056	1089	1123	1156	1189	1223	1256	1291	1324

W 22 D 20.75  
 H 39 SH 25.25

COM Yardage: 1 or 2 seats: .75 yard  
 Contact Leland Customer Experience for yardage requirements on textiles with repeats.  
 Optional Glides: Add \$8.00 net per chair for a set of four (4).



**Slam Sled  
 Counter Chair**

	MODEL	LIST PRICE/GRADE	COM/COL	A	B	C	D	E	F	G	H	I	J	K	L
Fully upholstered	SLCS-FU	Powder Coat	\$963	1079	1138	1196	1254	1313	1371	1429	1486	1545	1603	1661	1719
		Chrome	\$1042	1158	1216	1274	1333	1391	1449	1508	1566	1624	1682	1740	1798

W 22 D 20.75  
 H 39 SH 25.25

COM Yardage: 1.5 yards  
 Contact Leland Customer Experience for yardage requirements on textiles with repeats.  
 Optional Glides: Add \$8.00 net per chair for a set of four (4).

**To specify:**  
 Please refer to pages 3-4 for complete specifying information.  
 Specify all products by their product code.



**SLAM SLED COUNTER CHAIR**  
 Design: Lievore Altherr Molina, licensed by Sellex

**SL19**



**Slam Sled**

Counter Chair	MODEL	FRAME FINISH	LIST PRICE
3D Beech veneer shell	SLCS-3DB	Powder Coat	\$1265
W 22 D 20.75 H 39 SH 25		Chrome	\$1341

Optional Glides: Add \$8.00 net per chair for a set of four (4).



**Slam Sled**

Counter Chair	MODEL	LIST PRICE/GRADE	COM/COL	A	B	C	D	E	F	G	H	I	J	K	L
3D Beech veneer shell, upholstered seat onlay	SLCS-3BU	Powder Coat	\$1402	1468	1501	1535	1568	1602	1635	1669	1703	1736	1769	1803	1836
		Chrome	\$1480	1546	1579	1612	1646	1679	1712	1746	1780	1813	1847	1880	1914

W 22 D 20.75  
 H 39 SH 25.25

COM Yardage: 1 or 2 seats: .75 yard  
 Contact Leland Customer Experience for yardage requirements on textiles with repeats.  
 Optional Glides: Add \$8.00 net per chair for a set of four (4).



**Slam Sled**

Counter Chair	MODEL	FRAME FINISH	LIST PRICE
3D Oak veneer shell	SLCS-3DO	Powder Coat	\$1427
W 22 D 20.75 H 39 SH 25		Chrome	\$1504

Optional Glides: Add \$8.00 net per chair for a set of four (4).



**Slam Sled**

Counter Chair	MODEL	LIST PRICE/GRADE	COM/COL	A	B	C	D	E	F	G	H	I	J	K	L
3D Oak veneer shell, upholstered seat onlay	SLCS-3OU	Powder Coat	\$1565	1631	1664	1697	1731	1765	1798	1832	1865	1898	1932	1965	1999
		Chrome	\$1642	1708	1741	1775	1808	1841	1876	1909	1943	1976	2009	2043	2076

W 22 D 20.75  
 H 39 SH 25.25

COM Yardage: 1 or 2 seats: .75 yard  
 Contact Leland Customer Experience for yardage requirements on textiles with repeats.  
 Optional Glides: Add \$8.00 net per chair for a set of four (4).

**To specify:**  
 Please refer to pages 3-4 for complete specifying information.  
 Specify all products by their product code.

**SLAM 4-LEG COUNTER CHAIR**  
 Design: Lievore Altherr Molina, licensed by Sellex

**SL20**



**Slam 4-Leg Counter Chair**

	MODEL	FRAME FINISH	LIST PRICE
Polypropylene shell	SLC4-PO	Powder Coat	\$880
W 22 D 19.75 H 37 SH 25		Chrome	\$952

Optional Glides: Add \$8.00 net per chair for a set of four (4). Optional Glides raise chair height .5 inch.



**Slam 4-Leg Counter Chair**

	MODEL	LIST PRICE/GRADE	COM/COL	A	B	C	D	E	F	G	H	I	J	K	L
Polypropylene shell, upholstered seat onlay	SLC4-PU	Powder Coat	\$1018	1085	1118	1152	1185	1218	1252	1285	1319	1353	1386	1420	1453
		Chrome	\$1093	1158	1192	1225	1259	1293	1326	1359	1393	1426	1460	1493	1527

W 22 D 19.75  
 H 37.25 SH 25.25

Optional Glides: Add \$8.00 net per chair for a set of four (4). Optional Glides raise chair height .5 inch.  
 COM Yardage: 1 or 2 seats: .75 yard  
 Contact Leland Customer Experience for yardage requirements on textiles with repeats.  
 For COL requirements please contact Leland Customer Experience.



**Slam 4-Leg Counter Chair**

	MODEL	LIST PRICE/GRADE	COM/COL	A	B	C	D	E	F	G	H	I	J	K	L
Fully upholstered	SLC4-FU	Powder Coat	\$1177	1292	1351	1409	1467	1526	1584	1642	1700	1759	1817	1874	1932
		Chrome	\$1254	1371	1429	1486	1545	1603	1661	1719	1778	1836	1894	1953	2011

W 22 D 19.75  
 H 37.25 SH 25.25

Optional Glides: Add \$8.00 net per chair for a set of four (4). Optional Glides raise chair height .5 inch.  
 COM Yardage: 1.5 yards  
 Contact Leland Customer Experience for yardage requirements on textiles with repeats.  
 For COL requirements please contact Leland Customer Experience.

**To specify:**  
 Please refer to pages 3-4 for complete specifying information.  
 Specify all products by their product code.

**SLAM 4-LEG COUNTER CHAIR**  
 Design: Lievore Altherr Molina, licensed by Sellex

**SL21**



**Slam 4-Leg Counter Chair**

	MODEL	FRAME FINISH	LIST PRICE
3D Beech veneer shell	SLC4-3DB	Powder Coat	\$1470
W 22 D 19.75 H 37 SH 25		Chrome	\$1543

Optional Glides: Add \$8.00 net per chair for a set of four (4). Optional Glides raise chair height .5 inch.



**Slam 4-Leg Counter Chair**

	MODEL	LIST PRICE/GRADE	COM/COL	A	B	C	D	E	F	G	H	I	J	K	L
3D Beech veneer shell, upholstered seat onlay	SLC4-3BU	Powder Coat	\$1609	1675	1708	1741	1775	1808	1841	1876	1909	1943	1976	2009	2043
		Chrome	\$1682	1749	1782	1816	1849	1882	1916	1949	1982	2017	2050	2084	2117

W 22 D 19.75  
 H 37.25 SH 25.25

Optional Glides: Add \$8.00 net per chair for a set of four (4). Optional Glides raise chair height .5 inch.  
 COM Yardage: 1 or 2 seats: .75 yard  
 Contact Leland Customer Experience for yardage requirements on textiles with repeats.  
 For COL requirements please contact Leland Customer Experience.



**Slam 4-Leg Counter Chair**

	MODEL	FRAME FINISH	LIST PRICE
3D Oak veneer shell	SLC4-3DO	Powder Coat	\$1633
W 22 D 19.75 H 37 SH 25		Chrome	\$1706

Optional Glides: Add \$8.00 net per chair for a set of four (4). Optional Glides raise chair height .5 inch.



**Slam 4-Leg Counter Chair**

	MODEL	LIST PRICE/GRADE	COM/COL	A	B	C	D	E	F	G	H	I	J	K	L
3D Oak veneer shell, upholstered seat onlay	SLC4-3OU	Powder Coat	\$1772	1837	1871	1904	1938	1972	2005	2038	2072	2105	2138	2172	2205
		Chrome	\$1847	1912	1946	1979	2013	2046	2079	2114	2147	2180	2214	2247	2280

W 22 D 19.75  
 H 37.25 SH 25.25

Optional Glides: Add \$8.00 net per chair for a set of four (4). Optional Glides raise chair height .5 inch.  
 COM Yardage: 1 or 2 seats: .75 yard  
 Contact Leland Customer Experience for yardage requirements on textiles with repeats.  
 For COL requirements please contact Leland Customer Experience.

**To specify:**  
 Please refer to pages 3-4 for complete specifying information.  
 Specify all products by their product code.

**SLAM SLED BAR CHAIR**  
 Design: Lievore Altherr Molina, licensed by Sellex

**SL22**



<b>Slam Sled Bar Chair</b>	<b>MODEL</b>	<b>FRAME FINISH</b>	<b>LIST PRICE</b>
Polypropylene shell  W 22 D 20.75 H 43 SH 30	SLBS-PO	Powder Coat	\$758
		Chrome	\$824

Optional Glides: Add \$8.00 net per chair for a set of four (4).



<b>Slam Sled Bar Chair</b>	<b>MODEL</b>	<b>LIST PRICE/GRADE</b>	<b>COM/COL</b>	<b>A</b>	<b>B</b>	<b>C</b>	<b>D</b>	<b>E</b>	<b>F</b>	<b>G</b>	<b>H</b>	<b>I</b>	<b>J</b>	<b>K</b>	<b>L</b>
Polypropylene shell, upholsteredseat onlay  W 22 D 20.75 H 43 SH 30.25	SLBS-PU	Powder Coat	\$843	910	943	976	1010	1043	1076	1110	1143	1177	1211	1244	1278
		Chrome	\$908	974	1008	1041	1074	1108	1141	1174	1208	1242	1275	1309	1342

COM Yardage: 1 or 2 seats: .75 yard  
 Contact Leland Customer Experience for yardage requirements on textiles with repeats.  
 Optional Glides: Add \$8.00 net per chair for a set of four (4).



<b>Slam Sled Bar Chair</b>	<b>MODEL</b>	<b>LIST PRICE/GRADE</b>	<b>COM/COL</b>	<b>A</b>	<b>B</b>	<b>C</b>	<b>D</b>	<b>E</b>	<b>F</b>	<b>G</b>	<b>H</b>	<b>I</b>	<b>J</b>	<b>K</b>	<b>L</b>
Fully upholstered  W 22 D 20.75 H 43 SH 30.25	SLBS-FU	Powder Coat	\$994	1111	1169	1227	1286	1344	1402	1461	1519	1576	1634	1693	1751
		Chrome	\$1060	1177	1234	1292	1351	1409	1467	1526	1584	1642	1700	1759	1817

COM Yardage: 1.5 yards  
 Contact Leland Customer Experience for yardage requirements on textiles with repeats.  
 Optional Glides: Add \$8.00 net per chair for a set of four (4).

**To specify:**  
 Please refer to pages 3-4 for complete specifying information.  
 Specify all products by their product code.

# SLAM SLED BAR CHAIR

Design: Lievore Altherr Molina, licensed by Sellex

# SL23



Slam Sled Bar Chair	MODEL	FRAME FINISH	LIST PRICE
3D Beech veneer shell	SLBS-3DB	Powder Coat	\$1349
W 22 D 20.75 H 43 SH 30		Chrome	\$1416
Optional Glides: Add \$8.00 net per chair for a set of four (4).			



Slam Sled Bar Chair	MODEL	LIST PRICE/GRADE	COM/COL	A	B	C	D	E	F	G	H	I	J	K	L
3D Beech veneer shell, upholstered seat onlay	SLBS-3BU	Powder Coat	\$1489	1554	1588	1622	1655	1689	1722	1755	1789	1822	1855	1889	1923
W 22 D 20.75 H 43 SH 30.25		Chrome	\$1663	1729	1762	1796	1830	1863	1896	1930	1963	1996	2030	2063	2098
COM Yardage: 1 or 2 seats: .75 yard															
Contact Leland Customer Experience for yardage requirements on textiles with repeats.															
Optional Glides: Add \$8.00 net per chair for a set of four (4).															



Slam Sled Bar Chair	MODEL	FRAME FINISH	LIST PRICE
3D Oak veneer shell	SLBS-3DO	Powder Coat	\$1512
W 22 D 20.75 H 43 SH 30		Chrome	\$1579
Optional Glides: Add \$8.00 net per chair for a set of four (4).			



Slam Sled Bar Chair	MODEL	LIST PRICE/GRADE	COM/COL	A	B	C	D	E	F	G	H	I	J	K	L
3D Oak veneer shell, upholstered seat onlay	SLBS-3OU	Powder Coat	\$1651	1718	1751	1784	1818	1851	1885	1918	1951	1986	2019	2052	2086
W 22 D 20.75 H 43 SH 30.25		Chrome	\$1500	1566	1599	1633	1666	1699	1734	1767	1801	1834	1867	1901	1934
COM Yardage: 1 or 2 seats: .75 yard															
Contact Leland Customer Experience for yardage requirements on textiles with repeats.															
Optional Glides: Add \$8.00 net per chair for a set of four (4).															

**To specify:**

Please refer to pages 3-4 for complete specifying information. Specify all products by their product code.

**SLAM 4-LEG BAR CHAIR**  
 Design: Lievore Altherr Molina, licensed by Sellex

**SL24**



<b>Slam 4-Leg Bar Chair</b>	<b>MODEL</b>	<b>FRAME FINISH</b>	<b>LIST PRICE</b>
Polypropylene shell	SLB4-PO	Powder Coat	\$897
W 22 D 19.75 H 43 SH 30		Chrome	\$972
Optional Glides: Add \$8.00 net per chair for a set of four (4).			



<b>Slam 4-Leg Bar Chair</b>	<b>MODEL</b>	<b>LIST PRICE/GRADE</b>	<b>COM/COL</b>	<b>A</b>	<b>B</b>	<b>C</b>	<b>D</b>	<b>E</b>	<b>F</b>	<b>G</b>	<b>H</b>	<b>I</b>	<b>J</b>	<b>K</b>	<b>L</b>
Polypropylene shell, upholstered seat onlay	SLB4-PU	Powder Coat	\$1037	1102	1136	1169	1202	1236	1269	1302	1337	1370	1404	1437	1470
W 22 D 19.75 H 43.25 SH 30.25		Chrome	\$1110	1175	1209	1243	1277	1310	1343	1377	1410	1443	1477	1511	1544
Optional Glides: Add \$8.00 net per chair for a set of four (4). Optional Glides raise chair height .5 inch. COM Yardage: 1 or 2 seats: .75 yard Contact Leland Customer Experience for yardage requirements on textiles with repeats. For COL requirements please contact Leland Customer Experience.															



<b>Slam 4-Leg Bar Chair</b>	<b>MODEL</b>	<b>LIST PRICE/GRADE</b>	<b>COM/COL</b>	<b>A</b>	<b>B</b>	<b>C</b>	<b>D</b>	<b>E</b>	<b>F</b>	<b>G</b>	<b>H</b>	<b>I</b>	<b>J</b>	<b>K</b>	<b>L</b>
Fully upholstered	SLB4-FU	Powder Coat	\$1197	1314	1372	1430	1489	1546	1604	1662	1721	1779	1837	1895	1954
W 22 D 19.75 H 43.25 SH 30.25		Chrome	\$1274	1391	1449	1508	1566	1624	1682	1740	1798	1856	1914	1973	2031
Optional Glides: Add \$8.00 net per chair for a set of four (4). Optional Glides raise chair height .5 inch. COM Yardage: 1.5 yards Contact Leland Customer Experience for yardage requirements on textiles with repeats. For COL requirements please contact Leland Customer Experience.															

**To specify:**  
 Please refer to pages 3-4 for complete specifying information.  
 Specify all products by their product code.

# SLAM SLED BAR CHAIR

Design: Lievore Altherr Molina, licensed by Sellex

# SL25



Slam 4-Leg Bar Chair	MODEL	FRAME FINISH	LIST PRICE
3D Beech veneer shell	SLB4-3DB	Powder Coat	\$1485
W 22 D 19.75 H 43 SH 30		Chrome	\$1561

Optional Glides: Add \$8.00 net per chair for a set of four (4). Optional Glides raise chair height .5 inch.



Slam 4-Leg Bar Chair	MODEL	LIST PRICE/GRADE	COM/COL	A	B	C	D	E	F	G	H	I	J	K	L
3D Beech veneer shell, upholstered seat onlay	SLB4-3BU	Powder Coat	\$1628	1694	1727	1761	1794	1829	1862	1895	1929	1962	1995	2029	2062
		Chrome	\$1702	1767	1801	1834	1867	1901	1934	1967	2002	2035	2068	2102	2135

W 22 D 19.75  
H 43.25 SH 30.25

Optional Glides: Add \$8.00 net per chair for a set of four (4). Optional Glides raise chair height .5 inch.  
COM Yardage: 1 or 2 seats: .75 yard  
Contact Leland Customer Experience for yardage requirements on textiles with repeats.  
For COL requirements please contact Leland Customer Experience.



Slam 4-Leg Bar Chair	MODEL	FRAME FINISH	LIST PRICE
3D Oak veneer shell	SLB4-3DO	Powder Coat	\$1649
W 22 D 19.75 H 43 SH 30		Chrome	\$1723

Optional Glides: Add \$8.00 net per chair for a set of four (4). Optional Glides raise chair height .5 inch.



Slam 4-Leg Bar Chair	MODEL	LIST PRICE/GRADE	COM/COL	A	B	C	D	E	F	G	H	I	J	K	L
3D Oak veneer shell, upholstered seat onlay	SLB4-3OU	Powder Coat	\$1791	1857	1891	1924	1958	1991	2024	2058	2091	2124	2158	2192	2226
		Chrome	\$1864	1930	1963	1996	2030	2063	2098	2131	2164	2198	2231	2264	2298

W 22 D 19.75  
H 43.25 SH 30.25

Optional Glides: Add \$8.00 net per chair for a set of four (4). Optional Glides raise chair height .5 inch.  
COM Yardage: 1 or 2 seats: .75 yard  
Contact Leland Customer Experience for yardage requirements on textiles with repeats.  
For COL requirements please contact Leland Customer Experience..

**To specify:**

**Please refer to pages 3-4 for complete specifying information. Specify all products by their product code.**

**SLAM TRANSPORT/STACKING DOLLY**  
 Design: Lievore Altherr Molina, licensed by Sellex

**SL26**

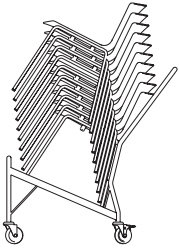

**Slam Transport/  
Stacking Dolly**

	MODEL	LIST PRICE
Black powder coat finish	SLD	\$1934
W 25 D 41.25 H 42 (Dimensions of dolly when empty)		
W 26 D 45 H 55 (Dimensions with stack)		

Slam Transport/Stacking Dolly capacity:  
 4-Leg Base: 10 high on dolly (8 high on floor)  
 4-Leg Mobile Base: 8 high on dolly (4 high on floor)  
 \*\*Sled and Aluminum Base does not stack

**To specify:**  
 Please refer to pages 3-4 for complete specifying information.  
 Specify all products by their product code.

**Pricing Effective: February 2022**



---

**5695 Eagle Drive, SE  
Grand Rapids,  
Michigan 49512  
616-975-9260  
lelandfurniture.com**

# Slam Beam

## February 2022 Price List



# Slam Beam

Table of Contents	SB2
Configurative Overview	SB3
Order Diagram	SB4
Visual Reference	SB5
Specification Information	SB8
Specification Example	SB9
Base, Two Position	SB10
Base, Three Position	SB11
Base, Four Position	SB12
Shell Specification Information	SB13
Specification Example	SB14
Shell Selection	SB15
Table Specification Information	SB17
Table Specification Example	SB18
Table	SB19
Floor Mount	SB20

## Slam Beam Seating Configuration

---

Slam Beam can be configured in many ways to meet the needs of your public space. The following pages will provide you a step by step process to correctly configure your benches. **Each purchase order submitted requires the diagram on page SB17 of this price list to be completed for every different bench model.** This is to ensure that the product you receive is exactly what you intended to purchase. If Leland can be of any assistance to you, please don't hesitate to contact our Customer Experience Department at 800-859-7510.

### 1. Base Selection

---

Begin configuring Slam Beam by selecting a base. Bases are available in three or four positions, either with arms or armless.

### 2. Shell Added to Base

---

The Slam shell is designed to fit one base position. Shells are available in polypropylene or 3D Veneer with or without upholstery. When placing an order, each shell is considered a separate product and will require its own model number.

### 3. Table Added to Base (Optional)

---

Slam Beam tables fit one base position. Table surface selections are available as a laminate. When placing an order, each table is considered a separate product and will require its own model number.

Please complete and include with your order. If multiple units are ordered, a diagram must be completed for each unique unit.

**1. Slam Beam Base Selection**

Select a three position or four position base model number:

The gray boxes below represent the seat/table positions of the model. Specify from left to right as seated. \*Note diagram (bottom is front of bench).

**TWO (2) POSITION**

SB2NA, two position, armless

SB22A, two position, two arm

SB23A, two position, three arm

**THREE (3) POSITION**

SB3NA, three position, armless

SB32A, three position, two arm

SB34A, three position, four arm

**FOUR (4) POSITION**

SB4NA, four position, armless

SB42A, four position, two arm

SB45A, four position, five arm

**2. SLAM BEAM SHELL AND TABLE SELECTION**

Please select either a shell or a table for each position on your base. Then choose the surface materials. Positions should be specified from left to right as seated.

**POSITION ONE POSITION TWO**

Shell

Polypropylene

Polypropylene

w/ Uph. Seat Onlay

Fully Uph.

Oak 3D Veneer

Oak 3D Veneer w/

Uph. Seat Onlay

Tables

**POSITION THREE**

Shell

Polypropylene

Polypropylene

w/ Uph. Seat Onlay

Fully Uph.

Oak 3D Veneer

Oak 3D Veneer w/

Uph. Seat Onlay

Tables

**POSITION FOUR**

Shell

Polypropylene

Polypropylene

w/ Uph. Seat Onlay

Fully Uph.

Oak 3D Veneer

Oak 3D Veneer w/

Uph. Seat Onlay

Tables

**POSITION FOUR**

Shell

Polypropylene

Polypropylene

w/ Uph. Seat Onlay

Fully Uph.

Oak 3D Veneer

Oak 3D Veneer w/

Uph. Seat Onlay

Tables

TWO POSITION ARMLESS

---

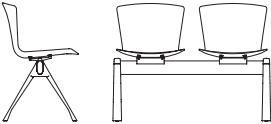

TWO POSITION, TWO ARM

---

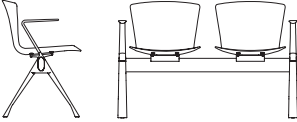

TWO POSITION, THREE ARM

---

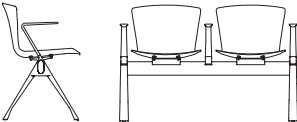

THREE POSITION ARMLESS

---

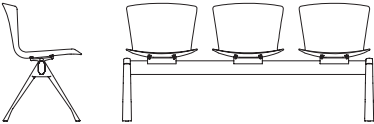

THREE POSITION, TWO ARM

---

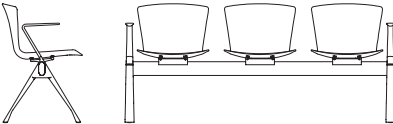

THREE POSITION, FOUR ARM

---

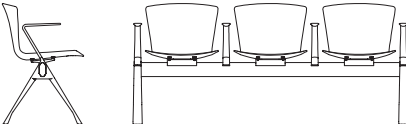

FOUR POSITION ARMLESS

---

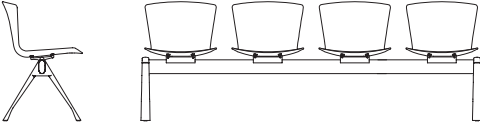

FOUR POSITION, TWO ARM

---

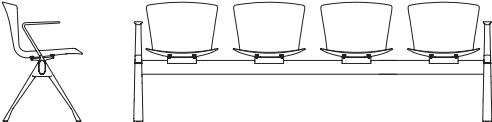

FOUR POSITION, FIVE ARM

---

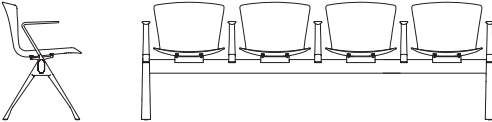



## Beam Model

---

TWO POSITION	CODE
Armless	SB2NA
Two Arm	SB22A
Three Arm	SB23A

THREE POSITION	CODE
Armless	SB3NA
Two Arm	SB32A
Four Arm	SB34A

FOUR POSITION	CODE
Armless	SB4NA
Two Arm	SB42A
Five Arm	SB45A

## Beam Finish

---

DESCRIPTION	CODE
White Textured Powder Coat	WT
Black Textured Powder Coat	BT
Grey Textured Powder Coat	GT
Sterling	ST

## Glides

---

Slam Beam glides are nylon.

## Auxiliary Options

---

DESCRIPTION	CODE
Floor Mount	FM

For a quote on Floor Mount options, please contact Customer Experience.

## Freight Note

---

Due to the size and nature of Slam Beam, the Freight Program does not apply to this product. Please contact Customer Experience for a quote.

**Specifications required to create the product code**

- Model
- Beam Finish
- Floor Mount (when applicable)



**MODEL**

Three position,  
Armless (SB3NA)

**BEAM FINISH**

White Textured Powder coat (WT)

**FLOOR MOUNT**

When applicable, enter Slam Beam  
Floor Mount Code (FM)



SLAM BEAM BASE, TWO POSITION  
Design: Lievore Altherr Molina, licensed by Sellex

# SB10

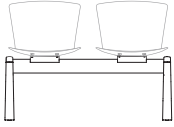

<b>Two Position, Armless</b>	<b>MODEL</b>	<b>LIST PRICE</b>
W 39.25 D 21 H 31	SB2NA Powdercoat	\$2284

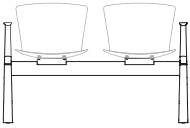

<b>Two Position, Two Arm</b>	<b>MODEL</b>	<b>LIST PRICE</b>
W 43.5 D 21 H 31	SB22A Powdercoat	\$2439

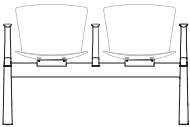

<b>Two Position, Three Arm</b>	<b>MODEL</b>	<b>LIST PRICE</b>
W 43.5 D 21 H 31	SB23A Powdercoat	\$2595

To specify:  
Refer to pages SB6-SB7

SLAM BEAM BASE, THREE POSITION  
Design: Lievore Altherr Molina, licensed by Sellex

# SB11

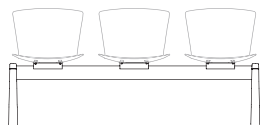

<b>Three Position, Armless</b>	<b>MODEL</b>	<b>LIST PRICE</b>
W 66 D 21 H 31	SB3NA Powdercoat	\$2425

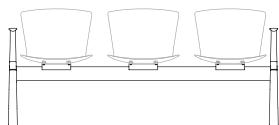

<b>Three Position, Two Arm</b>	<b>MODEL</b>	<b>LIST PRICE</b>
W 70.25 D 21 H 31	SB32A Powdercoat	\$2581

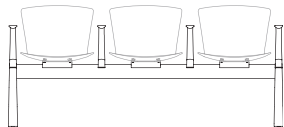

<b>Three Position, Three Arm</b>	<b>MODEL</b>	<b>LIST PRICE</b>
W 70.25 D 21 H 31	SB34A Powdercoat	\$2736

To specify:  
Refer to pages SB6-SB7

SLAM BEAM BASE, FOUR POSITION  
 Design: Lievore Altherr Molina, licensed by Sellex

# SB12

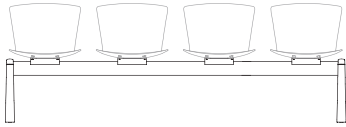

<b>Four Position, Armless</b>	<b>MODEL</b>	<b>LIST PRICE</b>
W 88.5 D 21 H 31	SB4NA Powdercoat	\$2788

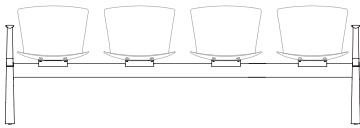

<b>Four Position, Two Arm</b>	<b>MODEL</b>	<b>LIST PRICE</b>
W 93 D 21 H 31	SB42A Powdercoat	\$2944

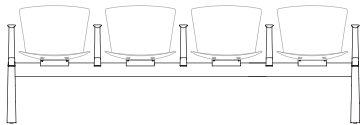

<b>Four Position, Five Arm</b>	<b>MODEL</b>	<b>LIST PRICE</b>
W 93 D 21 H 31	SB45A Powdercoat	\$3178

To specify:  
 Refer to pages SB6-SB7

## Shell Selection

DESCRIPTION	CODE
Polypropylene	PO
Polypropylene with Upholstered Seat Onlay	PU
Fully Upholstered	FU
Beech 3D Veneer	3DB
Beech 3D Veneer with Upholstered Seat Onlay	3BU
Oak 3D Veneer	3DO
Oak 3D Veneer with Upholstered Seat Onlay	3OU

## Shell Finish

### POLYPROPYLENE SHELL:

DESCRIPTION	CODE	DESCRIPTION	CODE
White	W	Grey	G
Black	B		

### CUSTOM POLYPROPYLENE COLORS

Custom color match is available upon request. Please contact hello@lelandinternational.com for further information

### BEECH 3D VENEER SHELL:

DESCRIPTION	CODE
Natural Beech	09

### STANDARD LELAND COLORS

### OAK 3D VENEER SHELL:

DESCRIPTION	CODE
Natural White Oak	12
Custom	CST

## Shell Finish/Color

### POLYPROPYLENE SHELL:

DESCRIPTION	CODE	DESCRIPTION	CODE
White	WT	Arctic	AR
Black	BK	Caribbean	CB
Soda Red	SR	Ink	IN
Dolphin	DL	Limelight	LL
Oxford	OX	Tangerine	TN
Ice Blue	IB		

### CUSTOM POLYPROPYLENE COLORS

Custom color match is available upon request. Please contact hello@lelandfurniture.com for further information

### BEECH 3D VENEER SHELL:

DESCRIPTION	CODE
Natural Beech	09

### STANDARD LELAND COLORS

### AMERICAN WALNUT 3D VENEER SHELL:

DESCRIPTION	CODE
Natural Walnut Matte	08M

## Shell Finish/Color (cont)

### FULLY UPHOLSTERED SHELL

Please refer to Leland Textile Program which features textiles and leathers from the following partners:

- Camira
- Green Hides
- Carnegie
- Maharam
- CF Stinson
- Unika Vaev

The complete grade list can be found at [www.lelandfurniture.com/ecatalog](http://www.lelandfurniture.com/ecatalog) or you can specify COM/COL. Due to the design of this product, it is recommended that all non pre-approved textile be tested for compatibility.

### Upholstered Onlay selection

Please refer to Leland Textile Program which features textiles and leathers from the following partners:

- Camira
- Green Hides
- Carnegie
- Maharam
- CF Stinson
- Unika Vaev

The complete grade list can be found at [lelandinternational.com/ecatalog](http://lelandinternational.com/ecatalog) or you can specify COM/COL. Due to the design of this product, it is recommended that all non pre-approved textile be tested for compatibility.

**Specifications required to create the product code**

- Shell Selection
- Shell Finish
- Upholstered Onlay Selection (When Applicable)

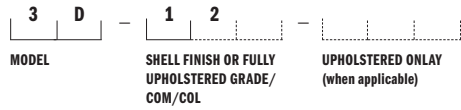

**SHELL SELECTION**

3D Veneer Shell (3D)

**SHELL FINISH**

Natural White Oak (12)

**UPHOLSTERED ONLAY SELECTION**

When applicable, enter upholstery grade, COM or COL

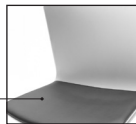

SLAM BEAM SHELL SELECTION  
 Design: Lievore Altherr Molina, licensed by Sellex

# SB15



Polypropylene	MODEL	LIST PRICE
	PO	\$186



Polypropylene W/ Upholstered Seat Only	MODEL	COM/COL	A	B	C	D	E	F	G	H	I	J	K	L
	PU	\$307	374	407	441	474	507	541	574	607	642	675	708	742

COM Yardage: 1 or 2 seats: .75 yard  
 Contact Leland Customer Experience for yardage requirements on textiles with repeats.  
 For COL requirements please contact Leland Customer Experience.



Fully Upholstered	MODEL	COM/COL	A	B	C	D	E	F	G	H	I	J	K	L
	FU	\$436	505	540	575	610	646	680	716	752	786	822	856	891

COM Yardage: 1 or 2 seats: .75 yard  
 Contact Leland Customer Experience for yardage requirements on textiles with repeats.  
 For COL requirements please contact Leland Customer Experience.

To specify:  
 Refer to pages SB11-SB12



SLAM BEAM SHELL SELECTION  
 Design: Lievore Altherr Molina, licensed by Sellex

# SB16



3D Beech Veneer	MODEL	LIST PRICE
	3DB	\$622



3D Beech Veneer W/ Upholstered Seat Only	MODEL	COM/COL	A	B	C	D	E	F	G	H	I	J	K	L
	3BU	\$746	812	845	880	913	946	980	1013	1046	1080	1113	1146	1181

COM Yardage: 1 or 2 seats: .75 yard  
 Contact Leland Customer Experience for yardage requirements on textiles with repeats.  
 For COL requirements please contact Leland Customer Experience.



3D Oak Veneer	MODEL	LIST PRICE
	3DO	\$785



3D Oak Veneer W/ Upholstered Seat Only	MODEL	COM/COL	A	B	C	D	E	F	G	H	I	J	K	L
	30U	\$908	974	1008	1041	1074	1108	1141	1174	1208	1242	1275	1309	1342

COM Yardage: 1 or 2 seats: .75 yard  
 Contact Leland Customer Experience for yardage requirements on textiles with repeats.  
 For COL requirements please contact Leland Customer Experience.

To specify:  
 Refer to pages SB11-SB12

**Table Model**

---

DESCRIPTION	CODE
Slam table	SBT

**Top Finish or Color**

---

**LAMINATE TOP:**

DESCRIPTION	CODE
Black (Pionite® Suede Black)	LBK
White (WilsonArt® Designer White) LWH Custom	CST

**Edge Finish**

---

DESCRIPTION	CODE
Opaque Black	B
Opaque White	W
Natural	11

**Specifications required to create the product code**

- Table Model
- Top Finish
- Edge Finish



**TABLE MODEL**

Slam Beam Table (SBT)

**TOP FINISH**

White Laminate (W)

**EDGE FINISH**

Opaque White (W)



Slam Beam Table	MODEL	FRAME FINISH	LIST PRICE
one base position	SBT	Laminate	\$296

W 22 D 22  
TH 17.75 (MOUNTED TO BASE)

Please note that Opaque White and Opaque Black Edge Finishes will have an additional \$20 NET charge.



To specify:  
Refer to pages SB14-SB15

Slam Beam Floor Mount	MODEL	LIST PRICE
	SBFM	\$196

Floor mount must be specified at the time of order.  
Due to the variety of floor surfaces on which Slam Beam may be installed, floor mount fasteners are not supplied by Leland.  
Responsibility of fastener choice is the customers.

To specify:  
Refer to pages SB14-SB15

---

**5695 Eagle Drive, SE**  
**Grand Rapids,**  
**Michigan 49512**  
**616-975-9260**  
**[lelandfurniture.com](http://lelandfurniture.com)**

# Valeri Seating

## February 2022 Price List



# Valeri

Table of Contents	VS2
Specification Information	VS3
Specification Example	VS4
Guest Chair, Lounge Chair, Settee	VS5



## Chair Model

---

DESCRIPTION	CODE
Valeri guest chair	VG
Valeri lounge chair	VL
Valeri settee	VS

## Frame Finish

---

DESCRIPTION	CODE
Brushed stainless steel	SS

## Upholstery Selection

---

Please refer to Leland Textile Program which features textiles and leathers from the following partners:

- Camira
- Carnegie
- CF Stinson
- Green Hides
- Maharam
- Unika Vaev

The complete grade list can be found at [lelandinternational.com/ecatalog](http://lelandinternational.com/ecatalog) or you can specify COM/COL. Due to the design of this product, it is recommended that all non pre-approved textile be tested for compatibility.

## Glides

---

Valeri glides are steel swivel with nylon bottom.

## Freight Note

---

Due to the size and nature of Valeri Seating, the Freight Program does not apply to this product. Please contact Customer Experience for a quote.

**Specifications required to create the product code**

- Model
- Frame Finish
- Upholstery Selection



**MODEL**

Valeri Lounge Chair (VL)

**FRAME FINISH**

Brushed Stainless Steel (SS)

**UPHOLSTERY SELECTION**

Enter upholstery grade, COM or COL. Grade J (J)





**Valeri Guest Chair**

	MODEL	LIST PRICE/ GRADE	COM/COL	A	B	C	D	E	F	G	H	I	J	K	L
W 21.5 D 23 H 29 SH 18 AH 24.5	VG		\$1537	1644	1699	1753	1808	1863	1917	1972	2027	2080	2135	2190	2244

COM Yardage: 1 or 2 chairs: 1.75 yards  
Contact Leland Customer Experience for yardage requirements on textiles with repeats.  
For COL requirements please contact Leland Customer Experience.

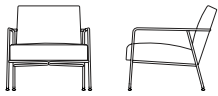

**Valeri Lounge Chair**

	MODEL	LIST PRICE/ GRADE	COM/COL	A	B	C	D	E	F	G	H	I	J	K	L
W 27.5 D 29.5 H 27 SH 15 AH 21	VL		\$2181	2335	2413	2491	2568	2645	2724	2801	2878	2956	3033	3112	3189

COM Yardage: 1 chair: 2.5 yards; 2 chairs: 3 yards; 3 or 4 chairs: 6 yards; 5 chairs: 6.5 yards  
Contact Leland Customer Experience for yardage requirements on textiles with repeats.  
For COL requirements please contact Leland Customer Experience.

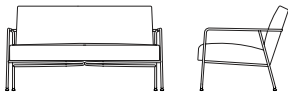

**Valeri Settee**

	MODEL	LIST PRICE/ GRADE	COM/COL	A	B	C	D	E	F	G	H	I	J	K	L
W 50 D 29.5 H 27 SH 15 AH 21	VS		\$3411	3721	3876	4031	4186	4341	4497	4652	4807	4962	5118	5273	5427

COM Yardage: 1 settee: 3 yards  
Due to upholstery requirements, Valeri Settee textile can only be upholstered railroaded.  
Please consider when specifying upholstery with a pattern or repeat.  
Contact Leland Customer Experience for yardage requirements on textiles with repeats.  
For COL requirements please contact Leland Customer Experience.

To specify:  
Please refer to pages 3-4 for complete specifying information.  
Specify all products by their product code.

---

**5695 Eagle Drive, SE  
Grand Rapids,  
Michigan 49512  
616-975-9260  
lelandfurniture.com**

freshcoast collection

2022 Price List

Pricing Effective February 2022



**freshcoast** price list

---

- + terms and conditions: table of contents ..... 1
- + terms and conditions, ordering information .... 2-6
- + freight program ..... 7
- + chair and table size combination guide..... 8
- + shell art index..... 9-10

## ordering information

---

All orders must be submitted in writing by e-mail to:  
hello@lelandinternational.com

Specify each item by its product code and the corresponding model description, finish, upholstery and options offered in the price list. If the customer's current product order must match a previous order, freshcoast must be notified. A sample product from the original order must be submitted at the expense of the customer to assure uniformity of finish and construction. Orders with missing or incorrect information such as model, finish, color, pricing, etc. will be scheduled upon receipt of correct and complete information.

freshcoast products are specified for and installed in a variety of end user applications. It is the responsibility of the purchasing party to understand the end user's intent and purchase products appropriate for that application. freshcoast takes no responsibility for incorrect specifications. Acceptance and fulfillment of any purchase order does not imply that the product is suitable for a certain application. freshcoast will only warranty products that have been installed in applications for which they were designed.

If multiple delivery schedules are required, the customer must submit separate purchase orders for each delivery date.

## acknowledgment

---

Orders are only accepted by issuance of our formal acknowledgment. It is the purchaser's responsibility to check acknowledgments and invoices for accuracy. If there is any discrepancy, the customer must notify freshcoast within 72 hours. Failure to notify freshcoast within this time period will constitute acceptance of the order as acknowledged, and our acknowledgment is final and binding.

All acknowledgments will contain an estimated ship date. If for some reason the furniture must not ship earlier than the estimated ship date, please specify a "Do not ship before date" in your purchase order. We are not responsible for delays in scheduling or failure to make scheduled ship date due to strikes, lockouts or other labor complications, war, riots, Acts of God, fires, accidents, restraints affecting shipment or credit, reduced supply or excessive cost of fuel or raw material, delays from suppliers, compliance with government regulations or other unforeseen contingencies.

## wood finishes

---

Wood finishes can be light sensitive; therefore, care should be taken to avoid placing chairs in areas exposed to intense natural light. Due to variations common to all wood species, the color and grain characteristics of the finish samples may not exactly match that of the finished product. Custom finishes must meet factory approval and are subject to a \$100.00 minimum net mixing charge. Please allow up to three weeks to prepare the custom wood finish match sample. Orders will not be scheduled or acknowledged until finish material approval is received in writing. Due to limitations of the raw materials and the natural background color of wood, not all colors can be successfully reproduced. The suitability of a color for custom finish matching cannot always be determined beforehand. This is especially true in the case of custom colors submitted on non-wood products. If we are unable to produce a commercial match to your custom color you will be notified at the earliest possible date and no charge will be levied.

## laminates

---

The following are considered to be standard and are usually in stock.

freshcoast tables may be ordered with any laminate recommended for application on horizontal surfaces. For table pricing and lead times using laminates not listed, please contact freshcoast.

### FORMICA®

<http://www.formica.com/trade/laminate/swatches/>  
or call 800.367.6422

Select solid colors, wood grains or patterns  
Select number/name  
Select standard finishes  
Laminates with -58 (matte finish) are standard

### WILSONART®

<http://www.wilsonartcontract.com/pattern-availability/>  
or call 800.433.3222

Select laminate finish,  
Select freshcoast standard finish -38 (fine velvet texture) or -60 (matte)

### PIONITE®

[http://www.pionite.com/pionite/pages\\_pionite/pionite\\_colors.html](http://www.pionite.com/pionite/pages_pionite/pionite_colors.html)  
or call 800.746.6483

Select colors  
Order standard finish N (suede)

### customer's own material (com)

---

freshcoast reserves the right of preliminary approval of all COM, prior to order acceptance. Even after such preliminary approval, freshcoast reserves the right to reject COM if, upon physical inspection of the COM, it proves unacceptable for use on freshcoast products. When this occurs, the customer will be notified in writing with an explanation of the problem. A written release from the customer will be required for the order to be processed.

freshcoast cannot assume responsibility for durability, appearance or other qualities of customer's own material on the finished product and does not give any warranty with respect to COM. At freshcoast's discretion, additional yardage, labor charges, or handling surcharges may be required as a condition of COM acceptance. COM delivered to freshcoast without proper identification may be refused, and freshcoast shall have no responsibility for loss or any other claims. Excess fabric will not be returned unless specifically requested in writing.

Please contact freshcoast for yardage requirements on all COM fabrics which are patterned or narrower than 54 inches wide. Orders using COM will be rescheduled if the COM has not been received two (2) weeks prior to the original ship date. Every effort will be made to avoid a delay and to complete your order within the standard lead time.

All shipments of COM to freshcoast must be sent prepaid.  
COM should be sent to:

freshcoast  
5695 Eagle Drive SE  
Grand Rapids, Michigan 49512

COM packages must include the following information:

- + Name of customer
- + Purchase order number to which the material is to be applied and freshcoast Sales Order, if known.

Purchase orders specifying COM must include the following:

- + Indicate which side of the fabric is to be exposed (manufacturer's implied face will be used if no side is indicated by the customer).
- + If fabric is a stripe or pattern, specify vertical or horizontal upholstered application. (fabric will be applied off the bolt if no direction is indicated by the customer).
- + COM suppliers' name, fabric number and quantities of pieces to which the material is to be applied.

### california technical bulletin 133

---

TB 133 is a full scale fire performance test of complete articles of seating furniture. Some freshcoast products in combination with a variety of upholstery fabrics have been tested and are in compliance with TB 133. Test documentation is available upon request. If you wish to specify freshcoast products that have not been tested for compliance with TB 133 please consult freshcoast for TB 133 testing cost information.

In order for freshcoast products to comply with TB 133 the foam must be protected with a fire-blocker or a special fire retardant foam must be used. For those products that must comply with TB 133 there will be a net charge for fire blocker laminating or fire retardant foam. Please contact freshcoast for a CAL 133 quotation on all seating.

Since TB 133 tests furniture and not components there are no TB 133 approved fabrics. Fabrics comprised solely or in any combination of the following fibers are more likely to be suitable components for chairs that must comply with TB 133:

Acrylic	Nylon
Vinyl	Animal Hairs
Polyester	Virgin Wool
Cordura	Rayon
Viscose	Cotton
SEF Modacrylic	Modacrylic
Leather	Silk
Worsted Wool	Wool
Spun Nylon	Mohair Trevira



## prices

---

All prices are list prices F.O.B. our factory in Grand Rapids, Michigan 49512. Our pricing includes packing and corrugated cartoning for common carrier shipments. List prices do not include freight, storage, taxes or additional packaging for certain carriers and are subject to change without notice.

We reserve the right to change quotation prices prior to acceptance by the buyer. Quotation prices must be accepted within 30 days or re-submitted for dating and approval. Pricing on orders specifying shipment 90 days or more after the formal date of acknowledgment will be based on pricing prevailing at time of shipment.

## resale rights

---

freshcoast reserves the right to reject any order placed by any customer for any reason, irrespective of whether orders have been previously accepted from such customer, without incurring liability to such customer. No customer shall have a continuing right to buy products from the company except pursuant to a formal dealer agreement or other written agreement covering future supply executed by the company and the reseller. Distribution of the price list or catalog does not itself constitute an offer to sell.

## credit and payment terms

---

An open account may be established for new customers. One bank and three trade references will be required and must be e-mailed to the freshcoast accounting department. Credit will be established upon review and approval of your application.

Allow up to four weeks delay for credit approval. To avoid this delay orders on new accounts must be accompanied by a 50% deposit.

If credit is approved by the time the order is ready for shipment, the balance must be paid within terms. Accounts that are inactive for a twelve month period will automatically be closed and are subject to the above conditions for new accounts. freshcoast may change or cancel credit at its discretion and may request advance payment at any time.

Upon establishment of an open account, terms are "Net 15 Days" after date of invoice with a credit limit established on a per customer basis. 1 ½ % per month service charge will be added to all past due accounts. Orders will not be processed for past due accounts until the amount due, including any service charge, is paid in full. All custom orders will require a down payment of 50% and will not be scheduled for production until the full down payment is received.

freshcoast reserves the right to revoke the terms of any customer at any time for any reason.

## changes and cancellations

---

Orders are not subject to change or cancellation without factory approval. freshcoast will make every reasonable effort to stop production scheduling, shipment, etc., upon receipt of written notification of changes, cancellations or deferrals stipulated as follows. Approved cancellations, changes, and delivery date extensions may be subject to charges.

## order changes

---

Order changes received prior to production will be charged \$100 net to cover administrative costs. Orders received after production has started, involving only an increase in quantity, will not be assessed a charge. Orders for special finishes are not subject to change after work has been started. Orders for upholstered chairs may not be changed after upholstery cover has been cut. The customer will receive the goods as ordered and be liable for amount due.

## cancellations

---

Cancellations received prior to production will be assessed a \$100 net cancellation charge. Cancellations received after production has been started will be assessed the total accumulated cost of the project plus a \$100 net cancellation charge.

## deferred shipments

---

If the order is complete in the production cycle, charges will be assessed from the completion date in accordance with policy for "Storage by the Manufacturer."

## storage by the manufacturer

---

If the customer cannot accept delivery when merchandise is ready, per acknowledged ship date according to the terms of our acknowledgment, we reserve the right to transfer goods to storage at the customer's expense, and the order will be invoiced at the time of storage. Payment of this invoice will be due on the original terms given to the customer. Storage charges and freight charges for delivery will be invoiced separately upon release of the merchandise from storage and will be due upon receipt of the invoice. Orders put into storage require payment in full and all incurred storage charges must be paid prior to the order being shipped.

## shipping

---

We will ship in accordance with the customer's written instructions. If customer omits specific shipping instructions, we will ship in the manner that we consider to be the best way. All shipments are sent F.O.B. Grand Rapids, Michigan 49512. freshcoast's liability ends when received by the carrier at freshcoast's dock. Title of the goods and risk of loss transfers to the buyer at that time. Freight shall be paid by the buyer unless otherwise acknowledged in writing by freshcoast. We make every effort to ship orders complete and on schedule. We reserve the right to make partial shipments as merchandise is ready. Failure to deliver all the merchandise at one time does not relieve the customer of the obligation to accept and pay for merchandise received.

## damage claims

---

All freshcoast products are thoroughly inspected prior to shipment from our factory and packed to comply with carrier requirements. Customers must carefully inspect all items upon arrival and note any damage on the delivery receipt. Phrasing such as "Subject to Inspection" does not constitute a note of damage and will not be accepted as grounds for honoring a freight claim. A written claim must be filed within 15 days of receipt with the carrier if any obvious or subsequent concealed damage is discovered and still does not guarantee the honoring of any freight claim. Caution: When a clear receipt is obtained by a carrier, freshcoast, nor the carrier, are no longer responsible for damages or shortages. Processing claims for damage and shortages are the responsibility of the buyer unless otherwise specified in writing by freshcoast. At no time can claims be deducted from our invoices.

## storage by owner

---

Due to the inherent nature of wood products, we cannot guarantee any product stored or set in place in an environment where temperature and humidity are not controlled. Temperatures must be maintained within a range of 50°-80° F (10°-27° C); the relative humidity must be maintained between 25% and 40%. These conditions are also recommended for human health standards.

## product discrepancy

---

Errors in products including color, size, other variations, or missing components must be reported to freshcoast within thirty (30) days of delivery. Failure by the purchaser to report any product inaccuracies within thirty (30) days of delivery shall constitute acceptance of the product.

## miscellaneous

---

All costs for furniture installation, removal from service and reinstallation due to damage claims, partial shipments, shipping errors or warranty claims is the responsibility of the customer. freshcoast will not be liable for costs associated with any of the above conditions.

All sizes and weights are considered to be approximate. freshcoast reserves the right to make changes in design and construction or discontinue products without notice. Due to conditions beyond our control all wood products, fabrics and vinyls are subject to variations in color, texture and grain.

Price list specifications supersede all other specifications whether verbal or written, and may not be altered without the written consent of an officer of freshcoast. All clerical errors on any agreement, publication, correspondence, price list, or product literature pieces are subject to correction at any time.

## maintenance

---

Since chairs and tables are installed and used under a variety of conditions, users must make inspections no less than every six months to look for damage or signs of structural fatigue incurred in daily handling, use and abuse. Examinations must include welds, machine screw assemblies and the shell to base fasteners. If problems are discovered that could compromise the structural safety of a chair, it should be immediately removed from service and freshcoast should be notified. Coats and other articles should not be hung on the back of chairs. This practice may cause chairs to be unstable. Chairs are not designed to be placed seat down on table surfaces. Chairs stored in this manner are unstable. The shock of chairs falling from table tops may compromise the structural integrity of the shell/base attachment.

## warranty

---

All merchandise is manufactured in accordance with our high industrial and design standards and is warranted to be free from defects of material and workmanship for a period of (5) five years from the date of delivery or placement in storage. This warranty covers goods under normal use and is in service under conditions for which the merchandise is designed. freshcoast considers normal use to be (5) five days per week (8) eight hours per day. Extended use (multiple shifts, 24 hour facilities, etc) will reduce this warranty to (2) two years. We offer no warranty on chair upholstery materials, plastic laminate table surfaces and operating components other than those expressed by the manufacturer of those components.

Our obligation during this warranty period is limited to repair or replacement at our option. This warranty becomes null and void on any goods repaired or altered by any person not so authorized by freshcoast or any merchandise which has been subject to misuse, improper storage, including placing chairs seat down on tables, negligence, or accident. We make no other warranties either expressed or implied as to any matter whatsoever, including without limitation, the condition of the merchandise, its merchantability, or its fitness for any particular user or purpose.

All claims will be processed by the Customer Care Department. All returns must be authorized in writing. Merchandise authorized for return and subsequent repair or replacement merchandise shall be removed from service. All shipping, packaging, and installation charges shall be at the expense of the customer. Since furniture is installed and used under a variety of conditions, users are required to make inspections every six months to look for damage or signs of structural fatigue incurred in daily handling, use, or abuse. Inspections must include, but are not limited to, the tightening of bolts and fasteners, and the lubrication of mechanisms.

Failure to properly maintain freshcoast products will void this warranty.

freshcoast will not be liable for loss of time, inconvenience, commercial loss, or incidental or consequential damages that may result from a warranty claim.

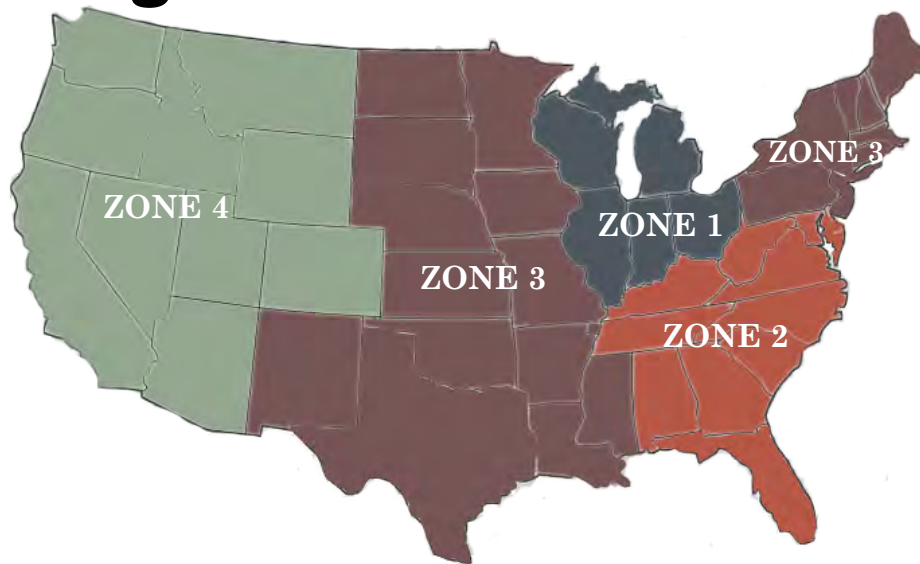

Zone 1 (4%)	Zone 2 (5%)	Zone 3 (6%)	Zone 3 (6%) CONT.	Zone 4 (7%)
Indiana	Alabama	Arkansas	New Hampshire	Arizona
Illinois	Delaware	Connecticut	New Jersey	California
Michigan	Florida	Iowa	New Mexico	Colorado
Ohio	Georgia	Kansas	New York	Idaho
Wisconsin	Kentucky	Louisiana	North Dakota	Montana
	Maryland	Maine	Oklahoma	Nevada
	North Carolina	Massachusetts	Pennsylvania	Oregon
	South Carolina	Minnesota	Rhode Island	Utah
	Tennessee	Mississippi	South Dakota	Washington
	Virginia	Missouri	Texas	Wyoming
	Washington DC	Nebraska	Vermont	
	West Virginia			

## Overview

Leland Furniture's Freight Program is offered to all customers for convenient and competitive freight prices in the continental United States.

## How It Works

1. Determine the LIST value of your order.
2. Determine the zone to which the freight will be shipping (Zones 1-4)
3. Calculate your freight charges by multiplying the list price and applicable zone charges (e.g.: \$10,000 LIST order shipping to Arizona is  $\$10,000 \times 0.07 = \$700$  NET freight).
4. Verify that your calculated charges meet or exceed minimums.
5. Note on your PO "Freight determined by Leland Freight Program".

## Zone Percentages and Minimums

Zone 1	4%	Minimum \$350
Zone 2	5%	Minimum \$350
Zone 3	6%	Minimum \$350
Zone 4	7%	Minimum \$350

## Remember

Freight percentages are based on LIST price of order.

Leland Furniture Freight Program is based on dockside delivery only. Residential Delivery, Inside Delivery, etc. will incur additional charges; please contact Leland Customer Service for current prices.

Freight is FOB Grand Rapids, MI 49512; the receiving company is responsible for noting any damage at the time of delivery on the Delivery Receipt. Leland Furniture assumes no responsibility for freight damage, either noted on delivery receipt or concealed.

As fuel prices fluctuate, Leland Furniture reserves the right to add necessary fuel surcharges.

Leland Furniture reserves the right to change or discontinue the Freight Program at any time.

**recommended chair height and table combination**

Size pairings are based on the seat height of the chair.  
Table heights are paired with seating as ergonomically appropriate.  
These suggestions are based on international averages for child size by age and are considered to be approximate only.

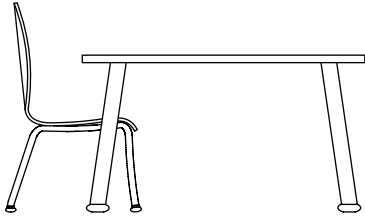

**ages 4-9**  
12" seat height  
20" table height

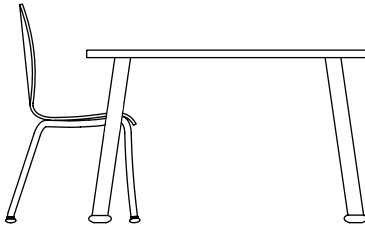

**ages 7-12**  
14" seat height  
22" table height

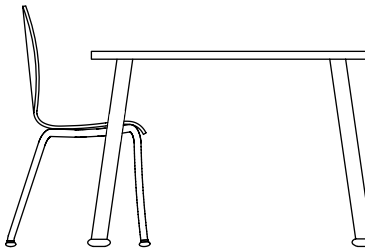

**ages 10-15**  
16" seat height  
25" table height

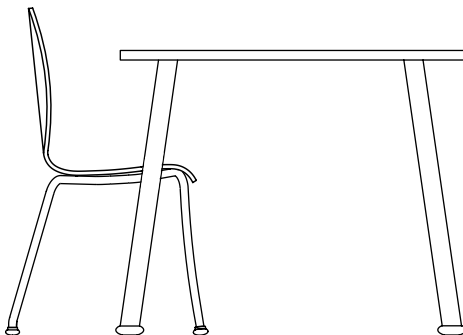

**adult**  
18" seat height  
29" table height

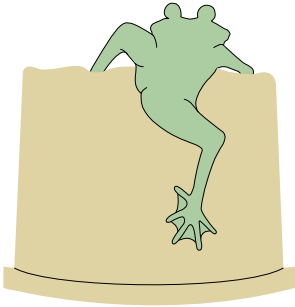

**eve creatures**

A CNC laser is used to cut a chair shell forming a three dimensional image on the chair back. Often, one side of the chair will show the creatures front side characteristics (such as eyes and nose) and the opposite side will show the creatures backside characteristics (such as a tail). Laser engraving and laser cutting is typically combined to create the different characteristics of the eve creature. See page EV3 for a complete list of eve creatures.

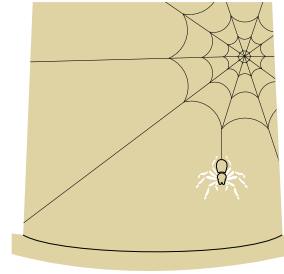

**laser engraving**

A CNC laser is used to make an engraving that penetrates the surface of the chair shell. The shell may be engraved on either or both sides.

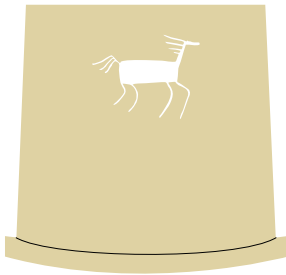

**laser cutout**

A CNC laser is used to cut through the back of the shell, forming an opening. This space creates an image that is visible from both sides of the chair shell.

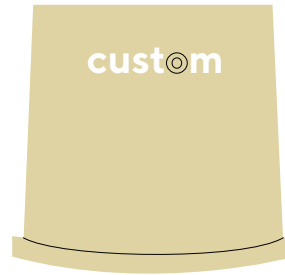

**custom**

You dream it, we can do it.

**freshcoast shell art collections**

Please refer to the freshcoast children’s brochure for details on scale and placement of shell art. If no shell art is desired, use code F999.

**swamp things**

grade 1

description  
code



snake  
(F001)



lizard  
(F002)



tree frog  
(F003)



turtle  
(F004)

**safari**

grade 1

description  
code



rhinoceros  
(F005)



elephant  
(F006)



lioness  
(F007)



ostrich  
(F008)



giraffe  
(F009)

**petroglyphs**

grade 1

description  
code



ram  
(F010)



antelope  
(F011)



deer  
(F012)



caribou  
(F013)



horse  
(F014)

**birds**

grade 2

description  
code



hummingbird  
(F015)



owl  
(F016)



woodpecker  
(F017)



dove  
(F018)

**celestial**

grade 1&2

description  
code



moon  
(F019)



sun  
(F020)  
grade 1



star  
(F021)



saturn  
(F022)



shooting star  
(F023)  
grade 2



moon among stars  
(F024)

Original artwork is property of freshcoast Inc. All rights reserved. No part of this artwork may be reproduced or transmitted in any form or by any electronic means, including photocopying, or by any information or retrieval system, without written permission from the President or Director of freshcoast, Inc.

**freshcoast shell art collections, continued**

Please refer to the freshcoast children's brochure for details on scale and placement of shell art. If no shell art is desired, use code F999.

**sea life**  
grade 1&2

description  
code

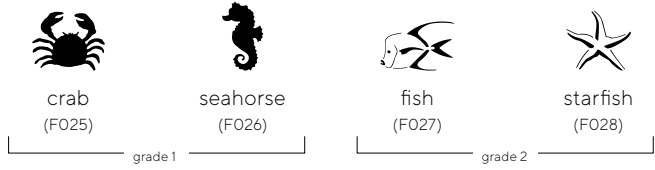

**animal tracks**  
grade 2

description  
code



**shapes**  
grade 1

description  
code

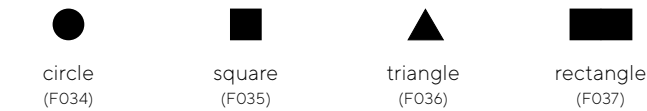

**dinosaurs**  
grade 1

description  
code



**insects**  
grade 1&2

description  
code

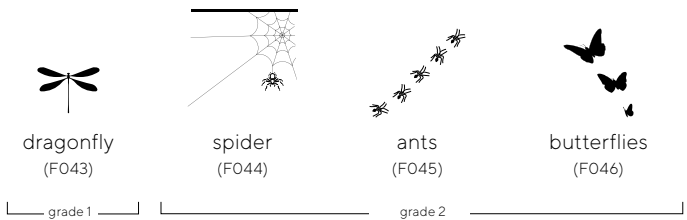

freshcoast collection  
**CHILDREN'S  
BEACH STONES**

2022 Price List

Pricing Effective February 2022





**children's beach stones price list**

---

+ beach stones: table of contents..... BSC2

+ beach stones specification information ..... BSC3

+ beach stones specification example..... BSC4

+ beach stones ..... BSC5-BSC6

**model**

DESCRIPTION	CODE
Beach Stone A	BSA
Beach Stone B	BSB
Beach Stone B with wood back	BSBW
Beach Stone C	BSC
Beach Stone C with wood back	BSCW
Beach Stone D	BSD

Wood back is only offered on B and C benches.

**back finish (wood back only)**

**TRANSPARENT FINISHES (SEMI-GLOSS SHEEN)**

DESCRIPTION	CODE
natural	11
medium	13
neutral	15
classic mahogany	21
white wash II	30
espresso	23
transparent black	29
graphite	25

**SEMI-TRANSPARENT FINISHES (MATTE-SHEEN)**

DESCRIPTION	CODE
arctic II	16M
ink II	18M
limelight	33M
caribbean II	48M
soda red	46M
tangerine	40M
ice blue	47M
oxford II	49M
dolphin II	50M

**shell art (wood back only)**

Due to thickness of the wood back, only shell art listed below is available. When viewed from the front, all shell art will be placed on the upper left area of back.

DESCRIPTION	CODE	DESCRIPTION	CODE
moon	F019	circle	F034
sun	F020	square	F035
star	F021	triangle	F036

**upholstery selection**

Please refer to freshcoast Textile Program which features textiles and leathers from the following partners:

- Camira
- Carnegie
- CF Stinson
- Green Hides
- Maharam
- Unika Vaev

The complete grade list can be found at [www.fc.studio/textile-partners](http://www.fc.studio/textile-partners) or you can specify COM/COL. Due to the design of this product, it is recommended that all non pre-approved textile be tested for compatibility. Contact freshcoast for yardage requirements on textiles with repeats.

**base finish**

Black textured powder coat

## SPECIFICATIONS REQUIRED TO CREATE THE PRODUCT CODE

- + **Model**
- + **Wood Back Finish (when applicable)**
- + **Wood Back Shell Art (when applicable)**
- + **Upholstery Selection**

**B S B W** - **1 1** - **F 0 3 4** - **C O M**  
MODEL BACK FINISH SHELL ART UPHOLSTERY SELECTION  
(WHEN APPLICABLE) (WHEN APPLICABLE)

### model

Beach Stone B with wood back (BSBW)

### back finish

Natural (11)

### shell art

Shapes, Circle (F034)

### upholstery selection

Upholstered (COM)



children's seating

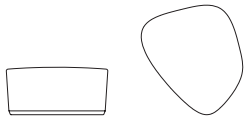

beach stone A	model	com/col	a	b	c	d	e	f	g	h	i	j	k	l
fully upholstered	BSA	\$879	976	1024	1073	1121	1170	1218	1266	1315	1363	1412	1460	1509
W26.75 D28.75 H12.5		COM yardage: 2 yds. Contact freshcoast customer care for COL requirements, textile testing requirements and yardage requirements for textiles with repeats.												

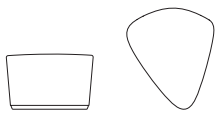

beach stone B	model	com/col	a	b	c	d	e	f	g	h	i	j	k	l
fully upholstered	BSB	\$921	1005	1046	1088	1129	1171	1213	1254	1295	1337	1378	1420	1461
W23 D26.5 H14.5		COM yardage: 1.5 yds. Contact freshcoast customer care for COL requirements, textile testing requirements and yardage requirements for textiles with repeats.												

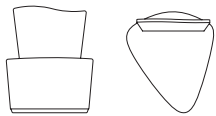

beach stone B	model	list price/grade	com/col	a	b	c	d	e	f	g	h	i	j	k	l
fully upholstered, wood back	BSBW	plain back	\$1153	1236	1278	1319	1361	1403	1444	1486	1528	1569	1611	1652	1694
		shell art	\$1201	1284	1326	1366	1408	1450	1491	1533	1575	1616	1658	1699	1741
W23 D26.5 H28.25 SH14.5		COM yardage: 1.5 yds. Contact freshcoast customer car for COL requirements, textile testing requirements and yardage requirements for textiles with repeats.													

to specify: please refer to pages 3-4 for complete specifying information. Specify all products by their product code.

pricing effective: February 2022

children's seating



beach stone C	model	com/col	a	b	c	d	e	f	g	h	i	j	k	l
fully upholstered	BSC	\$943	1026	1068	1109	1151	1193	1234	1276	1317	1359	1400	1442	1484
W25.5 D22.25 H16.5		COM yardage: 2 yds. Contact freshcoast customer care for COL requirements, textile testing requirements and yardage requirements for textiles with repeats.												

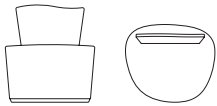

beach stone C	model		com/col	a	b	c	d	e	f	g	h	i	j	k	l
fully upholstered, wood back	BSCW	plain back	\$1176	1260	1301	1343	1384	1426	1467	1509	1550	1592	1634	1675	1717
W25.5 D22.25 H27.75 SH16.5		shell art	\$1221	1304	1346	1388	1429	1471	1513	1554	1596	1638	1679	1720	1761
			COM yardage: 2 yds. Contact freshcoast customer care for COL requirements, textile testing requirements and yardage requirements for textiles with repeats.												



beach stone D	model	list price/grade	com/col	a	b	c	d	e	f	g	h	i	j	k	l
fully upholstered	BSD		\$974	1141	1224	1307	1390	1473	1556	1639	1723	1806	1889	1972	2055
W39 D24.75 H24.5			COM yardage: 3 yds. Contact freshcoast customer care for COL requirements, textile testing requirements and yardage requirements for textiles with repeats.												

to specify: please refer to pages 3-4 for complete specifying information. Specify all products by their product code.

pricing effective: February 2022

freshcoast collection  
**BEACH STONES**

2022 Price List

Pricing Effective July 2022



freshcoast  
by LELAND

**beach stones price list**

---

+ beach stones: table of contents..... BSC2

+ beach stones specification information ..... BSC3

+ beach stones specification example..... BSC4

+ beach stones seating ..... BSC5

+ beach stone table..... BSC6

## model

DESCRIPTION	CODE
Beach Stone E	BSE
Beach Stone F	BSF
Beach Stone G	BSG
Beach Stone H	BSH
Beach Stone I	BSI
Beach Stone J	BSJ
Beach Stone K	BSK
Beach Stone L	BSL

## upholstery selection

Please refer to freshcoast Textile Program which features textiles and leathers from the following partners:

- Camira
- Carnegie
- CF Stinson
- Green Hides
- Maharam
- Unika Vaev

The complete grade list can be found at [www.fc.studio/textile-partners](http://www.fc.studio/textile-partners) or you can specify COM/COL. Due to the design of this product, it is recommended that all non pre-approved textile be tested for compatibility.

Contact freshcoast for yardage requirements on textiles with repeats.

## base finish

Black textured powder coat

## table top finish

### LAMINATE

DESCRIPTION	CODE
Black Laminate	LBK
White Laminate	LWH

### SOLID SURFACE

DESCRIPTION	CODE
Black Corian®	CB
White Corian®	CW
Grey Corian®	CG

### GLASS

DESCRIPTION	CODE
Black Back painted Glass	BG
White Back painted Glass	WG

## product weights

DESCRIPTION	LBS
Beach Stone E - BSE	50
Beach Stone F - BSF	50
Beach Stone G - BSG	50
Beach Stone H - BSH	50
Beach Stone I - BSI	50
Beach Stone J - BSJ	50
Beach Stone K - BSK	50
Beach Stone L - BSL	50



## SPECIFICATIONS REQUIRED TO CREATE THE PRODUCT CODE

---

- + Model
- + Upholstery Selection
- + Table Top Finish (when applicable)

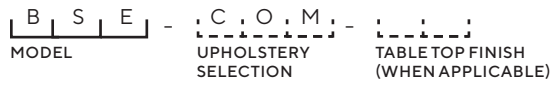

### model

---

Beach Stone E (BSE)

### upholstery selection

Upholstered (COM)



TABLE TOP FINISH  
When applicable

seating



beach stone e	model	com/col	a	b	c	d	e	f	g	h	i	j	k	l
<b>fully upholstered</b>	BSE	\$1398	1564	1647	1731	1814	1897	1980	2063	2146	2229	2312	2396	2479
W32 D24 H25 SH18		COM yardage: 2.5 yds. Contact freshcoast customer care for COL requirements, textile testing requirements and yardage requirements for textiles with repeats.												



beach stone F	model	com/col	a	b	c	d	e	f	g	h	i	j	k	l
<b>fully upholstered</b>	BSF	\$1375	1541	1624	1708	1791	1874	1957	2040	2123	2206	2289	2373	2456
W32 D24 H26 SH18		COM yardage: 2.5 yds. Contact freshcoast customer care for COL requirements, textile testing requirements and yardage requirements for textiles with repeats.												

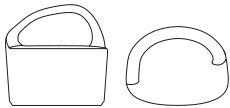

beach stone G	model	com/col	a	b	c	d	e	f	g	h	i	j	k	l
<b>fully upholstered</b>	BSG	\$1392	1559	1642	1725	1808	1891	1974	2057	2140	2224	2307	2390	2473
W32 D24 H31 SH18		COM yardage: 2.5 yds. Contact freshcoast customer care for COL requirements, textile testing requirements and yardage requirements for textiles with repeats.												



beach stone H	model	com/col	a	b	c	d	e	f	g	h	i	j	k	l
<b>fully upholstered</b>	BSH	\$927	1093	1176	1260	1343	1426	1509	1592	1675	1758	1841	1925	2008
W48 D18 H18		COM yardage: 2.5 yds. Contact freshcoast customer care for COL requirements, textile testing requirements and yardage requirements for textiles with repeats.												



beach stone I	model	com/col	a	b	c	d	e	f	g	h	i	j	k	l
<b>fully upholstered</b>	BSI	\$835	946	1001	1056	1112	1167	1223	1278	1333	1389	1444	1500	1555
W33 D22 H18		COM yardage: 1.75 yds. Contact freshcoast customer care for COL requirements, textile testing requirements and yardage requirements for textiles with repeats.												

to specify: please refer to pages 3-4 for complete specifying information. Specify all products by their product code.

tables

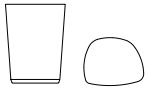

beach stone J	model	top finish	com/col	a	b	c	d	e	f	g	h	i	j	k	l
upholstered w/ table	BSJ	Laminate	\$976	1031	1059	1086	1114	1142	1170	1197	1225	1253	1280	1308	1336
		Corian	\$1464	1547	1589	1629	1671	1713	1755	1796	1838	1880	1920	1962	2004

W17 D13 H22

COM yardage: 1 yd.

Contact freshcoast customer care for COL requirements, textile testing requirements and yardage requirements for textiles with repeats.

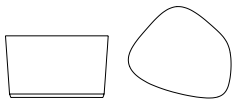

beach stone K	model	top finish	com/col	a	b	c	d	e	f	g	h	i	j	k	l
upholstered w/ table	BSK	Laminate	\$976	1086	1142	1197	1253	1308	1363	1419	1474	1530	1585	1641	1696
		Corian	\$1464	1629	1713	1796	1880	1962	2045	2129	2211	2295	2378	2462	2544

W30 D27 H18

COM yardage: 2 yds.

Contact freshcoast customer care for COL requirements, textile testing requirements and yardage requirements for textiles with repeats.

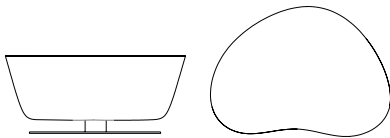

beach stone L	model	top finish	com/col	a	b	c	d	e	f	g	h	i	j	k	l
upholstered w/ table	BSL	Laminate	\$3053	3219	3302	3385	3468	3551	3634	3717	3801	3884	3967	4050	4133
		Corian	\$4580	4829	4953	5078	5202	5327	5451	5576	5702	5826	5951	6075	6200

W47 D34 H20

COM yardage: 3 yds.

Contact freshcoast customer care for COL requirements, textile testing requirements and yardage requirements for textiles with repeats.

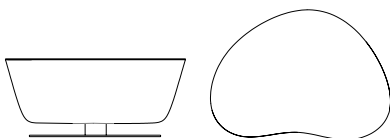

beach stone L	model	com/col	a	b	c	d	e	f	g	h	i	j	k	l
upholstered w/ backpainted glass	BSL	\$3331	3497	3580	3663	3746	3829	3913	3996	4079	4162	4245	4328	4411

W47 D34 H20

COM yardage: 3 yds.

Contact freshcoast customer care for COL requirements, textile testing requirements and yardage requirements for textiles with repeats.

to specify: please refer to pages 3-4 for complete specifying information. Specify all products by their product code.



freshcoast collection

**CRYSTAL  
CHILDREN'S TABLE**

2022 Price List

Pricing Effective February 2022



freshcoast  
by LELAND

**crystal children's table** price list

---

- + crystal table: table of contents ..... CYT2
- + crystal table specification information ..... CYT3
- + crystal table specification example ..... CYT4
- + crystal 20 inch height table ..... CYT5
- + crystal 22 inch height table ..... CYT6
- + crystal 25 inch height table ..... CYT7

**model**

DESCRIPTION	CODE
Crystal children's table	CYT

**table height**

DESCRIPTION	CODE
20 inch table height	20H
22 inch table height	22H
25 inch table height	25H

**base finish**

Select from freshcoast Colors I & II.

**top size**

ROUND CODE	CODE	SQUARE	CODE	RECTANGLE	CODE
36 dia	36D	36x36	3636	30x60	3060
42 dia	42D	42x42	4242		
48 dia	48D	48x48	4848		

**top surface finish or color**

**WOOD TOP:**

**TRANSPARENT FINISHES (SEMI-GLOSS SHEEN)**

DESCRIPTION	CODE
natural	11
medium	13
neutral	15
classic mahogany	21
espresso	23
white wash II	30
transparent black	29
graphite	25

**SEMI-TRANSPARENT FINISHES (MATTE-SHEEN)**

DESCRIPTION	CODE
arctic ii	16M
ink ii	18M
limelight	33M
caribbean II	48M
soda red	46M
tangerine	40M
ice blue	47M
oxford II	49M
dolphin II	50M

**top surface finish or color, cont.**

**LAMINATE TOP:**

DESCRIPTION	CODE
Identify manufacturer, laminate code, & color	L

Please refer to the freshcoast Terms and Conditions for a listing of standard laminates. For table pricing in laminates not listed, please contact freshcoast for a quotation.

**edge type**

**SOFT VINYL EDGE:**

DESCRIPTION	CODE
13/16" flat PVC	V2



**WOOD EDGE:**

DESCRIPTION	CODE
1" flat plywood	W2



**edge finish or color**

**SOFT VINYL EDGE:**

DESCRIPTION	CODE
black	B
white	W
grey	G

**WOOD EDGE:**

Select from freshcoast Colors I & II.

Wood top with wood edge must be specified in the same finish. Laminate top with wood edge may be specified in any freshcoast finish.

## SPECIFICATIONS REQUIRED TO CREATE THE PRODUCT CODE

- + **Model**
- + **Table Height**
- + **Base Finish**
- + **Top Size**
- + **Top Surface Finish or Color**
- + **Edge Type**
- + **Edge Finish or Color**

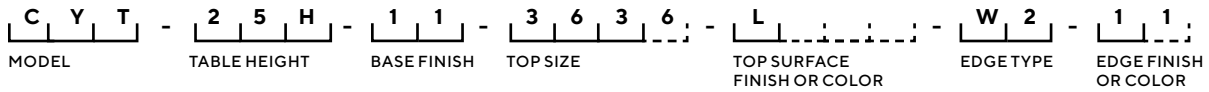

### MODEL

Crystal children's table (CYT)

### TABLE HEIGHT

25 inch table height (25H)

### BASE FINISH

Natural (11)

### TOP SIZE

36 X 36 (3636)

### TOP SURFACE FINISH OR COLOR

Laminate (L)

### EDGE TYPE

1 inch flat plywood (W2)



### EDGE FINISH OR COLOR

Natural (11)

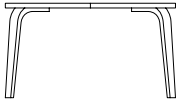

20 inch height



crystal table	model	top size/code	list price/edge codes	V2	W2
<b>curved plywood base</b>	CYT-20H	<b>wood top</b>			
H20		36 dia – 36D		\$1222	1526
 round	 square	42 dia – 42D		\$1255	1568
	 rectangle	48 dia – 48D		\$1289	1610
36 DIA	36 x 36	36 x 36 – 3636		\$1229	1537
42 DIA	42 x 42	42 x 42 – 4242		\$1260	1578
48 DIA	48 x 48	48 x 48 – 4848		\$1294	1619
		30 x 60 – 3060		\$1258	1573
		<b>laminatE top</b>			
		36 dia – 36D		\$1192	1488
		42 dia – 42D		\$1223	1529
		48 dia – 48D		\$1256	1569
		36 x 36 – 3636		\$1197	1496
		42 x 42 – 4242		\$1230	1538
		48 x 48 – 4848		\$1260	1579
		30 x 60 – 3060		\$1229	1535



to specify: please refer to pages 3-4 for complete specifying information. Specify all products by their product code.

pricing effective: January 25, 2022 4:02 PM



22 inch height







crystal table	model	top size/code	list price/edge codes	V2	W2
<b>curved plywood base</b>	CYT-22H	<b>wood top</b>			
H22		36 dia – 36D		\$1252	1566
 round	 square	42 dia – 42D		\$1286	1608
	 rectangle	48 dia – 48D		\$1319	1650
36 DIA	36 x 36	36 x 36 – 3636		\$1258	1578
42 DIA	42 x 42	42 x 42 – 4242		\$1292	1619
48 DIA	48 x 48	48 x 48 – 4848		\$1325	1659
		30 x 60 – 3060		\$1290	1616
		<b>laminatE top</b>			
		36 dia – 36D		\$1223	1529
		42 dia – 42D		\$1256	1569
		48 dia – 48D		\$1289	1609
		36 x 36 – 3636		\$1230	1538
		42 x 42 – 4242		\$1260	1579
		48 x 48 – 4848		\$1294	1619
		30 x 60 – 3060		\$1259	1576

to specify: please refer to pages 3-4 for complete specifying information. Specify all products by their product code.

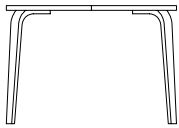
pricing effective: January 25, 2022 4:02 PM

25 inch height



crystal table	model	top size/code	list price/edge codes	V2	W2
<b>curved plywood base</b>	CYT-25H	<b>wood top</b>			
H25		36 dia – 36D		\$1289	1610
 round		42 dia – 42D		\$1321	1650
 square		48 dia – 48D		\$1355	1692
 rectangle		36 x 36 – 3636		\$1294	1619
36 DIA		42 x 42 – 4242		\$1326	1659
42 DIA		48 x 48 – 4848		\$1360	1701
48 DIA		30 x 60 – 3060		\$1324	1657
		<b>laminatE top</b>			
		36 dia – 36D		\$1256	1569
	42 dia – 42D		\$1289	1609	
	48 dia – 48D		\$1319	1649	
	36 x 36 – 3636		\$1260	1579	
	42 x 42 – 4242		\$1294	1619	
	48 x 48 – 4848		\$1325	1658	
	30 x 60 – 3060		\$1292	1616	

to specify: please refer to pages 3-4 for complete specifying information. Specify all products by their product code.

pricing effective: January 25, 2022 4:02 PM

freshcoast collection

**CRYSTAL  
CHILDREN'S LOW TABLE**

2022 Price List

Pricing Effective February 2022



freshcoast  
by LELAND

**crystal children's low table price list**

---

- + crystal low table: table of contents..... CYLT2
- + crystal low table specification information..... CYLT3
- + crystal low table specification example ..... CYLT4
- + crystal 12 inch height low table..... CYLT5
- + crystal 14 inch height low table..... CYLT6
- + crystal 16 inch height low table..... CYLT7
- + crystal 18 inch height low table..... CYLT8

### model

DESCRIPTION	CODE
Crystal low table	CYLT

### low table height

DESCRIPTION	CODE
12 inch low table height	12H
14 inch low table height	14H
16 inch low table height	16H
18 inch low table height	18H

### base finish

Select from freshcoast Colors I & II.

### top size

ROUND	CODE
26 dia	26D
36 dia	36D
42 dia	42D

### top surface finish or color

#### WOOD TOP:

#### TRANSPARENT FINISHES (SEMI-GLOSS SHEEN)

DESCRIPTION	CODE
natural	11
medium	13
neutral	15
classic mahogany	21
espresso	23
white wash II	30
transparent black	29
graphite	25

#### SEMI-TRANSPARENT FINISHES (MATTE-SHEEN)

DESCRIPTION	CODE
arctic ii	16M
ink ii	18M
limelight	33M
caribbean II	48M
soda red	46M
tangerine	40M
ice blue	47M
oxford II	49M
dolphin II	50M

### top surface finish or color, cont.

#### LAMINATE TOP:

DESCRIPTION	CODE
Identify manufacturer, laminate code, & color	L

Please refer to the freshcoast Terms and Conditions for a listing of standard laminates. For low table pricing in laminates not listed, please contact freshcoast for a quotation.

#### MARKER BOARD TOP:

DESCRIPTION	CODE
White surface for non-permanent dry erase markers.	M

Marker board top with W2 edge has Natural 11 edge finish.

### edge type

#### SOFT VINYL EDGE:

DESCRIPTION	CODE
13/16" flat PVC	V2

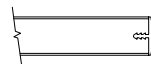

#### WOOD EDGE:

DESCRIPTION	CODE
1" flat plywood	W2



### edge finish or color

#### SOFT VINYL EDGE:

DESCRIPTION	CODE
black	B
white	W
grey	G

#### WOOD EDGE:

Select from freshcoast Colors

Wood top with wood edge must be specified in the same finish. Laminate top with wood edge may be specified in any freshcoast finish. Markerboard tops with wood edge have Natural 11 edge finish.

## SPECIFICATIONS REQUIRED TO CREATE THE PRODUCT CODE

- + **Model**
- + **Low Table Height**
- + **Base Finish**
- + **Top Size**
- + **Top Surface Finish or Color**
- + **Edge Type**
- + **Edge Finish or Color**



### MODEL

Crystal low table (CYLT)

### LOW TABLE HEIGHT

16 inch low table height (16H)

### BASE FINISH

Natural (11)

### TOP SIZE

36 dia (36D)

### TOP SURFACE FINISH OR COLOR

Markerboard (M)

### EDGE TYPE

1 inch flat plywood (W2)

### EDGE FINISH OR COLOR

Natural (11)



12 inch height

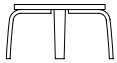

<b>crystal low table</b>	<b>model</b>	<b>top size/code</b>	<b>list price/edge codes</b>	<b>V2</b>	<b>W2</b>
<b>curved plywood base</b>	CYLT-12H	<b>wood top</b>			
H12		26 dia – 26D		\$610	764
		36 dia – 36D		\$693	866
round		42 dia – 42D		\$754	943
26 DIA		<b>laminate top</b>			
36 DIA		26 dia – 26D		\$589	738
42 DIA		36 dia – 36D		\$672	841
		42 dia – 42D		\$733	917
		<b>marker board top</b>			
		26 dia – 26D		\$896	1120
		36 dia – 36D		\$1183	1480
		42 dia – 42D		\$1472	1841

**to specify:** please refer to pages 3–4 for complete specifying information. Specify all products by their product code.

pricing effective: January 25, 2022 3:18 PM

**CYLT5**

14 inch height

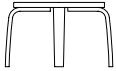

<b>crystal low table</b>	<b>model</b>	<b>top size/code</b>	<b>list price/edge codes</b>	<b>V2</b>	<b>W2</b>
<b>curved plywood base</b> H14  round 26 DIA 36 DIA 42 DIA	CYLT-14H	<b>wood top</b>			
		26 dia – 26D	\$676	846	
		36 dia – 36D	\$760	948	
		42 dia – 42D	\$820	1025	
		<b>lamine top</b>			
		26 dia – 26D	\$655	820	
		36 dia – 36D	\$738	924	
		42 dia – 42D	\$800	999	
		<b>marker board top</b>			
		26 dia – 26D	\$963	1202	
		36 dia – 36D	\$1250	1561	
		42 dia – 42D	\$1539	1922	

**to specify:** please refer to pages 3–4 for complete specifying information. Specify all products by their product code.

pricing effective: January 25, 2022 3:18 PM



16 inch seat height

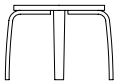

<b>crystal low table</b>	<b>model</b>	<b>top size/code</b>	<b>list price/edge codes</b>	<b>V2</b>	<b>W2</b>
<b>curved plywood base</b> H16  round 26 DIA 36 DIA 42 DIA	CYLT-16H	<b>wood top</b>			
		26 dia – 26D	\$726	906	
		36 dia – 36D	\$808	1010	
		42 dia – 42D	\$870	1087	
		<b>lamine top</b>			
		26 dia – 26D	\$705	882	
		36 dia – 36D	\$787	984	
		42 dia – 42D	\$850	1061	
		<b>marker board top</b>			
		26 dia – 26D	\$1012	1262	
		36 dia – 36D	\$1299	1624	
		42 dia – 42D	\$1588	1985	

**to specify:** please refer to pages 3–4 for complete specifying information. Specify all products by their product code.

pricing effective: January 25, 2022 3:18 PM

**CYLT7**

18 inch seat height

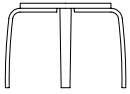

**crystal low table**

model

top size/code

list price/edge codes

V2

W2

**curved plywood base**

CYLT-18H

**wood top**

H18

26 dia – 26D

\$726

948



36 dia – 36D

\$808

1052

round

42 dia – 42D

\$903

1129

26 DIA

**laminate top**

36 DIA

26 dia – 26D

\$738

924

42 DIA

36 dia – 36D

\$820

1025

42 dia – 42D

\$883

1103

**marker board top**

26 dia – 26D

\$1046

1306

36 dia – 36D

\$1332

1666

42 dia – 42D

\$1621

2026

**to specify:** please refer to pages 3–4 for complete specifying information. Specify all products by their product code.

pricing effective: January 25, 2022 3:18 PM

**CYLT8**

freshcoast collection

**CRYSTAL  
CHILDREN'S STOOL**

2022 Price List

Pricing Effective February 2022



freshcoast  
by LELAND

**crystal children's stool price list**

---

- + crystal stool: table of contents ..... CYS2
- + crystal stool specification information..... CYS3
- + crystal stool specification example ..... CYS4
- + crystal 12 inch stool ..... CYS5
- + crystal 14 inch stool ..... CYS6
- + crystal 16 inch stool ..... CYS7
- + crystal 18 inch stool ..... CYS8

**model**

DESCRIPTION	CODE
Crystal stool	CYS

**seat height**

DESCRIPTION	CODE
12 inch seat height	SH12
14 inch seat height	SH14
16 inch seat height	SH16
18 inch seat height	SH18

**base finish**

Select from freshcoast Colors I & II.

**seat size**

ROUND	CODE
18 dia	18D
26 dia	26D
36 dia	36D

**seat surface finish or color**

**WOOD SEAT:**

**TRANSPARENT FINISHES  
(SEMI-GLOSS SHEEN)**

DESCRIPTION	CODE
natural	11
medium	13
neutral	15
classic mahogany	21
espresso	23
white wash II	30
transparent black	29
graphite	25

**SEMI-TRANSPARENT FINISHES  
(MATTE-SHEEN)**

DESCRIPTION	CODE
arctic ii	16M
ink ii	18M
limelight	33M
caribbean II	48M
soda red	46M
tangerine	40M
ice blue	47M
oxford II	49M
dolphin II	50M

**top surface finish or color, cont.**

**UPHOLSTERED SEAT:**

DESCRIPTION	CODE
Customer's Own Material	COM

Upholstery is Customer's Own Material (COM). Due to the design of this product, it is required that all non pre-approved textiles be tested for compatibility. Untested textiles will not be accepted. Contact freshcoast for yardage requirements on textiles with repeats.

Please refer to freshcoast Textile Program which features textiles and leathers from the following partners:

- Camira
- Carnegie
- CF Stinson
- Green Hides
- Maharam
- Unika Vaev

The complete grade list can be found at [www.fc.studio/textile-partners](http://www.fc.studio/textile-partners) or you can specify COM/COL. Due to the design of this product, it is recommended that all non pre-approved textile be tested for compatibility.

**edge type**

**SOFT VINYL EDGE:**

DESCRIPTION	CODE
13/16" flat PVC	V2



**WOOD EDGE:**

DESCRIPTION	CODE
1" flat plywood	W2



\*upholstered seat does not require an edge selection

**edge finish or color**

**SOFT VINYL EDGE:**

DESCRIPTION	CODE
black	B
white	W
grey	G

**WOOD EDGE:**

Select from freshcoast Colors I & II.

Wood top with wood edge must be specified in the same finish.

## SPECIFICATIONS REQUIRED TO CREATE THE PRODUCT CODE

- + **Model**
- + **Seat Height**
- + **Base Finish**
- + **Seat Size**
- + **Top Surface Finish / Color / Upholstery**
- + **Edge Type (when applicable)**
- + **Edge Finish or Color (when applicable)**

**C Y S** - **S H 1 6** - **1 1** - **3 6 D** - **6 5** - **W 2** - **6 5**  
MODEL SEAT HEIGHT BASE FINISH SEAT SIZE TOP SURFACE FINISH COLOR/UPHOLSTERY EDGE TYPE (WHEN APPLICABLE) EDGE FINISH OR COLOR (WHEN APPLICABLE)

### MODEL

Crystal stool (CYS)

### SEAT HEIGHT

16 inch seat height (SH16)

### BASE FINISH

Natural (11)

### SEAT SIZE

36 dia (36D)

### TOP SURFACE FINISH / COLOR / UPHOLSTERY

Lime (65)

### EDGE TYPE

1 inch flat plywood (W2)

### EDGE FINISH OR COLOR

Lime (65)



12 inch seat height

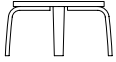

crystal stool	model	list price/grade	list price/edge codes	V2	W2
12" stool, curved plywood base, wood seat	CYS-SH12	18 dia – 18D		\$610	764
		26 dia – 26D		\$693	866
		36 dia – 36D		\$794	995

H12



round

18 DIA

26 DIA

36 DIA

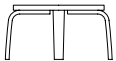

crystal stool	model	list price/grade	com/col	a	b	c	d	e	f	g	h	i	j	k	l
12" stool, curved plywood base, upholstered seat	CYS-SH12	18 dia – 18D	\$808	848	868	887	907	927	947	966	986	1006	1026	1046	1065
		26 dia – 26D	\$909	962	988	1015	1041	1068	1094	1120	1147	1173	1200	1226	1252
		36 dia – 36D	\$1039	1118	1158	1197	1237	1277	1316	1356	1395	1435	1474	1514	1554

H12



round

18 DIA

26 DIA

36 DIA

COM yardage: 18 dia: ¾ yd, 26 dia: 1 yd, 36 dia 1½ yds

Contact freshcoast customer care for COL requirements, textile testing requirements and yardage requirements for textiles with repeats.

to specify: please refer to pages 3–4 for complete specifying information. Specify all products by their product code.

14 inch seat height

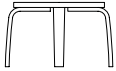

crystal stool	model	list price/grade	list price/edge codes	V2	W2
14" stool, curved plywood base, wood seat	CYS-SH14	18 dia – 18D		\$676	846
		26 dia – 26D		\$760	948
		36 dia – 36D		\$861	1078

H14



round

18 DIA

26 DIA

36 DIA

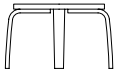

crystal stool	model	list price/grade	com/col	a	b	c	d	e	f	g	h	i	j	k	l
14" stool, curved plywood base, upholstered seat	CYS-SH14	18 dia – 18D	\$892	931	951	971	991	1010	1030	1050	1070	1090	1109	1129	1149
		26 dia – 26D	\$994	1047	1073	1100	1126	1152	1179	1205	1231	1258	1284	1311	1337
		36 dia – 36D	\$1123	1202	1241	1281	1321	1360	1400	1439	1479	1518	1558	1598	1637

H14



round

18 DIA

26 DIA

36 DIA

COM yardage: 18 dia: ¾ yd, 26 dia: 1 yd, 36 dia 1½ yds

Contact freshcoast customer care for COL requirements, textile testing requirements and yardage requirements for textiles with repeats.

to specify: please refer to pages 3–4 for complete specifying information. Specify all products by their product code.



16 inch seat height

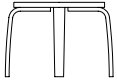

crystal stool	model	list price/grade	list price/edge codes	V2	W2
16" stool, curved plywood base, wood seat	CYS-SH16	18 dia – 18D		\$726	906
		26 dia – 26D		\$808	1010
		36 dia – 36D		\$909	1138

H16



round

18 DIA

26 DIA

36 DIA

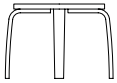

crystal stool	model	list price/grade	com/col	a	b	c	d	e	f	g	h	i	j	k	l
16" stool, curved plywood base, upholstered seat	CYS-SH16	18 dia – 18D	\$951	991	1010	1030	1050	1070	1090	1109	1129	1149	1169	1189	1208
		26 dia – 26D	\$1056	1108	1135	1161	1187	1214	1240	1267	1293	1319	1346	1372	1399
		36 dia – 36D	\$1183	1262	1302	1341	1381	1421	1460	1500	1539	1579	1619	1658	1698

H16



round

18 DIA

26 DIA

36 DIA

COM yardage: 18 dia: ¾ yd, 26 dia: 1 yd, 36 dia 1½ yds

Contact freshcoast customer care for COL requirements, textile testing requirements and yardage requirements for textiles with repeats.

to specify: please refer to pages 3–4 for complete specifying information. Specify all products by their product code.

18 inch seat height

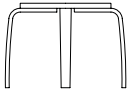

crystal stool	model	list price/grade	list price/edge codes	V2	W2
18" stool, curved plywood base, wood seat	CYS-SH18	18 dia – 18D		\$750	938
		26 dia – 26D		\$832	1040
		36 dia – 36D		\$937	1170

H18



round

18 DIA

26 DIA

36 DIA

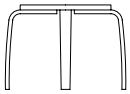

crystal stool	model	list price/grade	com/col	a	b	c	d	e	f	g	h	i	j	k	l
18" stool, curved plywood base, upholstered seat	CYS-SH18	18 dia – 18D	\$983	1023	1042	1062	1082	1102	1122	1141	1161	1181	1201	1220	1240
		26 dia – 26D	\$1086	1139	1165	1192	1218	1245	1271	1297	1324	1350	1377	1403	1429
		36 dia – 36D	\$1214	1293	1333	1372	1412	1451	1491	1531	1570	1610	1649	1689	1728

H18



round

18 DIA

26 DIA

36 DIA

COM yardage: 18 dia: ¾ yd, 26 dia: 1 yd, 36 dia 1½ yds

Contact freshcoast customer care for COL requirements, textile testing requirements and yardage requirements for textiles with repeats.

to specify: please refer to pages 3-4 for complete specifying information. Specify all products by their product code.

freshcoast collection

**EVE  
CHILDREN'S CHAIR**

2022 Price List

Pricing Effective February 2022

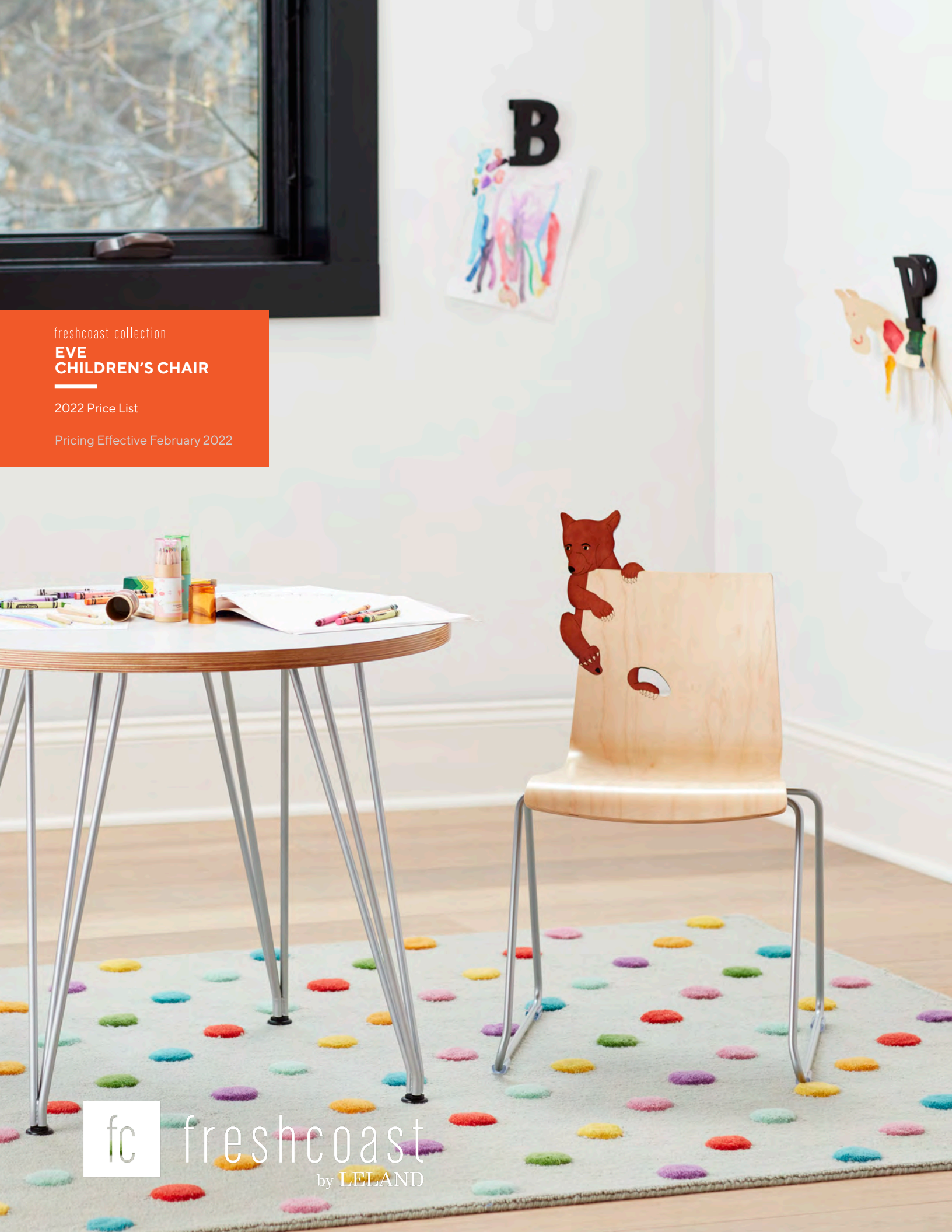

**eve children's chair price list**

---

- + eve chair: table of contents .....EV2
- + eve chair specification information .....EV3
- + eve chair specification example ..... EV5
- + eve 12 inch seat height chair ..... EV6
- + eve 14 inch seat height chair .....EV7
- + eve 16 inch seat height chair ..... EV8
- + eve 15 inch seat height sled base chair ..... EV9
- + eve task base chair ..... EV10

**model**

DESCRIPTION	CODE
Eve children's chair	EV
Eve children's chair, upholstered seat pad	EVU

**shell style - wetland creatures**

DESCRIPTION	CODE	DESCRIPTION	CODE
-------------	------	-------------	------



beaver medium (13) P001

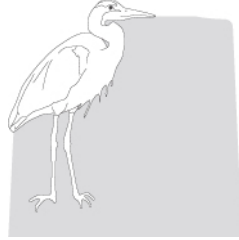

heron aegean (78) P002

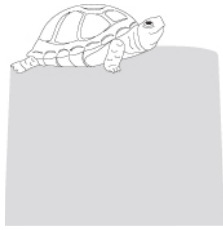

turtle lime (65) P003



frog sea grass (79) P004



duck citrus (73) P005



trout cactus (82) P006

**shell style - woodland creatures**

DESCRIPTION	CODE	DESCRIPTION	CODE
-------------	------	-------------	------



bear medium cherry (17) P007

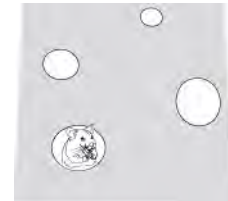

mouse aegean (78) P008



fox scarlet (83) P009



raccoon transparent nocturne (81) P010



eagle copper (22) P011

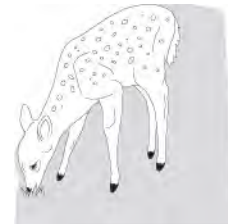

deer terra (84) P012

**SPECIFICATIONS CONTINUE ON NEXT PAGE**

### seat height

DESCRIPTION	CODE
12 inch seat height	SH12
14 inch seat height	SH14
15 inch seat height (wire sled base only)	SH15
16 inch seat height	SH16
13-16 inch seat height (task base only)	HATB

### base type

DESCRIPTION	CODE
solid wood	W
4-leg steel	4
wire sled	S
task	T

Black five star task base on hard casters is height adjustable with tilt.

### base finish

#### WOOD

Wood shell and wood base (excluding creature) is finished in Natural (11). Each creature's primary finish color is indicated in parenthesis on the previous page. Please note that freshcoast may use additional color to emphasize details and enhance the appearance of the creature.

#### 4-LEG STEEL & WIRE SLED

DESCRIPTION	CODE	DESCRIPTION	CODE
sterling	ST	matte gold rush	MGR
warm grey	WG	matte mercury	MMR
cool grey	CG	matte mineral	MMN
black	B	matte burnish	MBN
white	W	matte foundry	MFN
black textured	BT	soda red textured	SRT
grey textured	GT	tangerine textured	TNT
white textured	WT	ice blue textured	IBT
dolphin textured	DLT	arctic textured	ART
oxford textured	OXT	caribbean textured	CBT
ink textured	INT	limelight textured	LLT

#### TASK

DESCRIPTION	CODE
black	B

### upholstered seat pad

Upholstery is Customer's Own Material (COM) requiring ½ yd. per chair.

Due to the design of this product, it is required that all non pre-approved textiles be tested for compatibility. Untested textiles will not be accepted. Contact freshcoast for yardage requirements on textiles with repeats.

Please refer to freshcoast Textile Program which features textiles and leathers from the following partners:

- Camira
- Carnegie
- CF Stinson
- Green Hides
- Maharam
- Unika Vaev

The complete grade list can be found at [www.fc.studio/textile-partners](http://www.fc.studio/textile-partners) or you can specify COM/COL. Due to the design of this product, it is recommended that all non pre-approved textile be tested for compatibility.

### SPECIFICATIONS REQUIRED TO CREATE THE PRODUCT CODE

- + Model
- + Shell Style
- + Seat Height
- + Base Type
- + Base Finish
- + upholstered seat pad (when applicable)

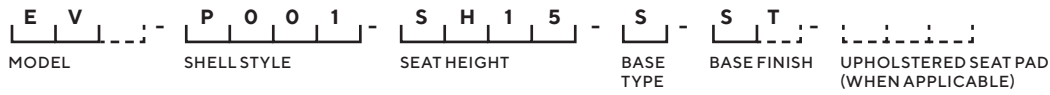

#### MODEL

Eve children's chair (EV)

#### SHELL STYLE

Wetland, Beaver (P001)

#### SEAT HEIGHT

15 inch seat height (SH15)

#### BASE TYPE

Wire Sled (S)

#### BASE FINISH

Sterling (ST)



#### UPHOLSTERED SEAT PAD SELECTION

When applicable

12 inch seat height



eve	model	list
12" seat height, solid wood base	EV-W	\$767

W15.5 D16.5 H23-27\*

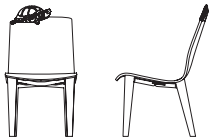

eve	model	com/col	a	b	c	d	e	f	g	h	i	j	k	l
12" seat height, solid wood base, upholstered seat pad	EVU-W	\$860	887	900	914	928	941	955	968	982	995	1009	1023	1036

W15.5 D16.5 H23-27\*

COM yardage: ½ yd.  
Contact freshcoast customer care for COL requirements, textile testing requirements and yardage requirements for textiles with repeats.



eve	model	list
12" seat height, four leg steel base	EV-4	\$597

W16.5 D18.75 H23-27\*



eve	model	com/col	a	b	c	d	e	f	g	h	i	j	k	l
12" seat height, four leg steel base, upholstered seat pad	EVU-4	\$700	727	740	753	766	780	793	806	819	832	846	859	872

W16.5 D18.75 H23-27\*

COM yardage: ½ yd.  
Contact freshcoast customer care for COL requirements, textile testing requirements and yardage requirements for textiles with repeats.

\*overall chair height varies based upon the selected eve creature

to specify: please refer to pages 3-4 for complete specifying information. Specify all products by their product code.



14 inch seat height



eve	model	list
14" seat height, solid wood base	EV-W	\$814

W15.75 D16.75 H25-29\*

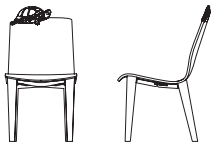

eve	model	com/col	a	b	c	d	e	f	g	h	i	j	k	l
14" seat height, solid wood base, upholstered seat pad	EVU-W	\$905	931	944	958	971	984	997	1010	1024	1037	1050	1063	1076

W15.75 D16.75 H25-29\*

COM yardage: ½ yd.  
Contact freshcoast customer care for COL requirements, textile testing requirements and yardage requirements for textiles with repeats.



eve	model	list
14" seat height, four leg steel base	EV-4	\$619

W16.75 D19 H25-29\*



eve	model	com/col	a	b	c	d	e	f	g	h	i	j	k	l
14" seat height, four leg steel base, upholstered seat pad	EVU-4	\$723	750	763	776	789	803	816	829	842	855	869	882	895

W16.75 D19 H25-29\*

COM yardage: ½ yd.  
Contact freshcoast customer care for COL requirements, textile testing requirements and yardage requirements for textiles with repeats.

\*overall chair height varies based upon the selected eve creature

to specify: please refer to pages 3-4 for complete specifying information. Specify all products by their product code.

pricing effective: August 3, 2022 3:43 PM

16 inch seat height



eve	model	list
16" seat height, solid wood base	EV-W	\$844

W16 D17 H27-31\*

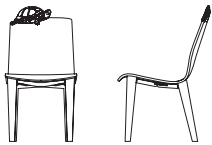

eve	model	com/col	a	b	c	d	e	f	g	h	i	j	k	l
16" seat height, solid wood base, upholstered seat pad	EVU-W	\$938	964	977	991	1004	1017	1030	1043	1057	1070	1083	1096	1109

W16 D17 H27-31\*

COM yardage: ½ yd.  
Contact freshcoast customer care for COL requirements, textile testing requirements and yardage requirements for textiles with repeats.



eve	model	list
16" seat height, four leg steel base	EV-4	\$652

W17 D19.25 H27-31\*



eve	model	com/col	a	b	c	d	e	f	g	h	i	j	k	l
16" seat height, four leg steel base, upholstered seat pad	EVU-4	\$754	781	794	807	820	833	847	860	873	886	899	913	926

W17 D19.25 H27-31\*

COM yardage: ½ yd.  
Contact freshcoast customer care for COL requirements, textile testing requirements and yardage requirements for textiles with repeats.

\*overall chair height varies based upon the selected eve creature

to specify: please refer to pages 3-4 for complete specifying information. Specify all products by their product code.

pricing effective: August 3, 2022 3:43 PM

15 inch seat height - sled base



eve	model	list price/grade	list
<b>15" seat height, wire sled base</b> W16 D18.25 H24-25*	EV-S	black	\$704
		sterling	\$733

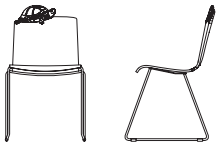

curve	model	list price/grade	com/col	a	b	c	d	e	f	g	h	i	j	k	l
<b>15" seat height, wire sled base, upholstered seat pad</b> W16 D18.25 H24-25*	EVU-S	black	\$807	833	847	860	873	886	899	913	926	939	952	965	979
		sterling	\$837	863	876	890	903	916	929	942	955	969	982	995	1008

COM yardage: 1/2 yd.  
 Contact freshcoast customer care for COL requirements, textile testing requirements and yardage requirements for textiles with repeats.

\*overall chair height varies based upon the selected eve creature

to specify: please refer to pages 3-4 for complete specifying information. Specify all products by their product code.

pricing effective: August 3, 2022 3:43 PM

13"-16" adjustable task base chair

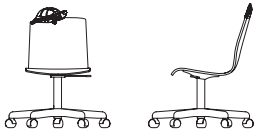

eve	model	list
13"-16" adjustable seat height, task base	EV-T	\$680
W22 D22 H23-31*		

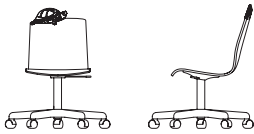

eve	model	com/col	a	b	c	d	e	f	g	h	i	j	k	l
13"-16" adjustable seat height, upholstered seat pad, task base	EVU-T	\$783	809	822	836	849	862	875	888	902	915	928	941	954
W22 D22 H23-31*		COM yardage: 1/2 yd. Contact freshcoast customer care for COL requirements, textile testing requirements and yardage requirements for textiles with repeats.												

\*overall chair height varies based upon the selected eve creature

to specify: please refer to pages 3-4 for complete specifying information. Specify all products by their product code.

pricing effective: August 3, 2022 3:43 PM

freshcoast collection  
**HANDY STOOL**

2022 Price List

Pricing Effective February 2022



**handy children's stool price list**

---

+ handy: table of contents ..... HA2  
+ handy specifications ..... HA3  
+ handy example..... HA4  
+ handy stool ..... HA5

### model

DESCRIPTION	CODE
Handy Polypropylene	HFC-P

### polypropylene shell

DESCRIPTION	CODE
White	WT
Black	BK
Grey	G
Yellow	YL
Orange	OR
Soda Red	SR
Blue	BU
Green	GN

#### CUSTOM POLYPROPYLENE COLORS

Custom color match is available upon request. Please contact [hello@lelandinternational.com](mailto:hello@lelandinternational.com) for further information

### seat height

DESCRIPTION	CODE
12 inch seat height	SH12
14 inch seat height	SH14
16 inch seat height	SH16
17.5 inch seat height	SH17

### glide options

DESCRIPTION	CODE
Poly (Standard)	S

### stacking note

For Handy, ALL models stack as follows:

Floor: 10 High



	17.5"H	16"	14"	12"
stack of 10:	44"H	42.5"	40.5"	38.5"
stack of 5:	29.5"H	28"	26"	24"

## SPECIFICATIONS REQUIRED TO CREATE THE PRODUCT CODE

---

- + **Model**
- + **Shell Finish**
- + **Seat Height**

**H F C** - **P** - **S H 1 7** - **W T**  
MODEL SEAT HEIGHT COLOR

### MODEL

---

Handy Stool (HFC-P)

### SEAT HEIGHT

17.5 inch seat height

### POLYPROPYLENE SHELL FINISH

White (WT)





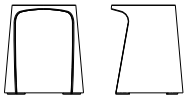

handy stool	model	list
polypropylene shell	HFC-P-SH17	\$178

W15.75 D14.25 H17.5

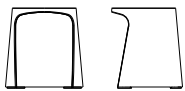

handy stool	model	list
polypropylene shell	HFC-P-SH16	\$178

W15.5 D14.25 H16



handy stool	model	list
polypropylene shell	HFC-P-SH14	\$178

W15.25 D14 H14



handy stool	model	list
polypropylene shell	HFC-P-SH12	\$178

W14.75 D13.75 H12

**to specify:** please refer to pages 3-4 for complete specifying information. Specify all products by their product code.

pricing effective: february 2022

freshcoast collection

**LITTLE MARQUETTE  
CHAIR**

2022 Price List

Pricing Effective February 2022



freshcoast  
by LELAND

**little marquette chair pricelist**

---

- + little marquette chair: table of contents ..... MQ2
- + little marquette chair specifications ..... MQ3
- + little marquette chair example ..... MQ4
- + little marquette chair ..... MQ5

model	code
<b>DESCRIPTION</b> Little Marquette chair	MQL

shell style	code
<b>DESCRIPTION</b> arc	A







<b>DESCRIPTION</b> crescent	C
--------------------------------	---



shell style
<b>DESCRIPTION</b> freshcoast Standard Wood Finishes custom (specify 01)

frame finish			
DESCRIPTION	CODE	DESCRIPTION	CODE
sterling	ST	matte gold rush	MGR
warm grey	WG	matte mercury	MMR
cool grey	CG	matte mineral	MMN
black	B	matte burnish	MBN
white	W	matte foundry	MFN
black textured	BT	soda red textured	SRT
grey textured	GT	tangerine textured	TNT
white textured	WT	ice blue textured	IBT
dolphin textured	DLT	arctic textured	ART
oxford textured	OXT	caribbean textured	CBT
ink textured	INT	limelight textured	LLT

glide options	code
<b>DESCRIPTION</b> Poly (Standard)	S
Felt	FC

optional back cut-out		
SWAMP THINGS SERIES		code
	lizard	1S
	frog *cutout is off center	2S
	turtle *cutout is off center	3S
	snake	4S

optional back cut-out cont.	
GEOMETRIC SERIES	
	code

 shapes 1G

 circle 2G

 square 3G

 triangle 4G

PETROGLYPH SERIES	
	code

 deer 1P

 antelope 2P

 lamb 3P

 horse 4P

CELESTIAL SERIES	
	code

 saturn 1C

 shooting star 2C

 starry night 3C

 moon 4C

## specifications required to create the product code

---

- Model
- Shell Style
- Back Cut-Out
- Shell Finish
- Frame Finish
- Glide Type

**M Q L - C - 1 S - 6 4 - S T - 1 ;**  
MODEL      SHELL FINISH      BACK CUT-OUT      SHELL FINISH      FRAME FINISH      GLIDE TYPE

### MODEL

---

Little Marquette Chair (MQL)

### SHELL STYLE

---

Crescent (C)

### BACK CUT-OUT

---

Lizard (1S)

### SHELL FINISH

---

freshcoast finish,  
sunflower (64)

### FRAME FINISH

---

Sterling (ST)

### GLIDE TYPE

---

Standard (S)





little marquette chair	model	list price
arc shell w16 d19 h28 sh15		
	powder coat frame	\$520
	chrome frame	\$554
	Optional Glides: Add \$8.00 net per chair for a set of four (4).	



little marquette chair	model	list price
crescent shell w16 d19 h28 sh15	<b>ML-C</b>	
	powder coat frame	\$520
	chrome frame	\$554
	Optional Glides: Add \$8.00 net per chair for a set of four (4).	

**to specify:** please refer to pages 3-4 for complete specifying information.  
Specify all products by their product code.

freshcoast collection  
**LITTLE MARQUETTE  
TABLE**

2022 Price List

Pricing Effective February 2022



**little marquette table** pricelist

---

- + little marquette table: table of contents ..... MT2
- + little marquette table specifications ..... MT3
- + little marquette table example ..... MT4
- + little marquette table ..... MT5



model	code
<b>DESCRIPTION</b> Little Marquette chair	MQL

**leg finish**

DESCRIPTION	CODE	DESCRIPTION	CODE
sterling	ST	matte gold rush	MGR
warm grey	WG	matte mercury	MMR
cool grey	CG	matte mineral	MMN
black	B	matte burnish	MBN
white	W	matte foundry	MFN
black textured	BT	soda red textured	SRT
grey textured	GT	tangerine textured	TNT
white textured	WT	ice blue textured	IBT
dolphin textured	DLT	arctic textured	ART
oxford textured	OXT	caribbean textured	CBT
ink textured	INT	limelight textured	LLT

**top size and shape**

**DESCRIPTION**



round

**code**



square

**code**



rectangle

**code**

36 dia

36 D

36 x 36

3636

30 x 60

3060

42 dia

42D

42 x 42

4242

**top finish or color**

**DESCRIPTION**

**wood tops**

freshcoast Wood Finishes ([view here](#))

custom (specify 01)

**DESCRIPTION**

**laminate tops**

Identify manufacturer, laminate code, & color

**code**

L

Please refer to the freshcoast Terms and Conditions Guide for a listing of standard laminates. For table pricing in laminates not listed, please contact freshcoast's Customer Experience Department for a quotation.

edge type	code
-----------	------

**DESCRIPTION**  
vinyl edges

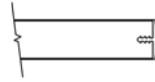

1 3/16" flat PVC

V2

**wood edges**



1" beveled plywood

W6



1" flat plywood

W2

**edge finish or color**

**code**

**DESCRIPTION**

vinyl edges

white

W

black

B

grey

G

**DESCRIPTION**

**wood edges**

freshcoast Wood Finishes ([view here](#))

custom (specify 01)

Please note that Marquette Tables are NOT AVAILABLE in the following finishes:

Natural Walnut Matte I08MI. Natural Beech I09I. Natural White Oak Matte I12MI

**DESCRIPTION**

**self edges**

For laminate tops, edge must be specified in the same laminate as top surface.

### specifications required to create the product code

---

- Model
- Leg Finish
- Top Size
- Top Finish or Color
- Edge Type
- Edge Finish or Color

**M L T** - **S T** - **3 6 3 6** - **L** - **W 6** - **1 1**  
MODEL      LEG FINISH      TOP SIZE      TOP FINISH      EDGE TYPE      EDGE FINISH

#### MODEL

---

Little Marquette Table (MLT)

#### LEG FINISH

Sterling Powdercoat (ST)

#### TOP SIZE

Square, 36 x 36 " (3636)

#### TOP FINISH

Laminate (L)

#### EDGE TYPE

1" beveled plywood

#### EDGE FINISH

Natural (11)



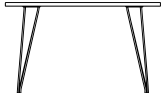

**little marquette table**

black base  
h 25

model

**MLT-B**

top size/code

list price/edge codes

V2

W6

W2



round

36 dia

42 dia

48 dia



square

36x36

42x42

48x48



rectangle

30x60

wood top

36 dia - 36D

\$1449

1901

1901

42 dia - 42D

\$1516

2035

2035

48 dia - 48D

\$1866

2059

2059

36x36 - 3636

\$1461

1913

1913

42x42 - 4242

\$1537

2051

2051

48x48 - 4848

\$1894

2088

2088

30x60 - 3060

\$1611

1971

1971

laminate top

36 dia - 36D

\$1280

1609

1609

42 dia - 42D

\$1537

1775

1775

48 dia - 48D

\$1557

1805

1805

36x36 - 3636

\$1295

1624

1624

42x42 - 4242

\$1554

1797

1797

48x48 - 4848

\$1589

1838

1838

30x60 - 3060

\$1439

1637

1637

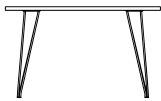

**little marquette table**

sterling base  
h 25

model

**MLT-ST**

top size/code

list price/edge codes

V6

W6

W2



round

36 dia

42 dia

48 dia



square

36x36

42x42

48x48



rectangle

30x60

wood top

36 dia - 36D

\$1600

2051

2051

42 dia - 42D

\$1669

2186

2186

48 dia - 48D

\$2018

2214

2214

36x36 - 3636

\$1610

2065

2065

42x42 - 4242

\$1686

2201

2201

48x48 - 4848

\$2047

2244

2244

30x60 - 3060

\$1764

2122

2122

laminate top

36 dia - 36D

\$1441

1814

1814

42 dia - 42D

\$1665

1990

1990

48 dia - 48D

\$1676

2020

2020

36x36 - 3636

\$1457

1827

1827

42x42 - 4242

\$1697

2008

2008

48x48 - 4848

\$1710

2051

2051

30x60 - 3060

\$1659

1845

1845

**to specify:** please refer to pages 3-4 for complete specifying information.  
Specify all products by their product code.

freshcoast collection

**MANITOU  
CHILDREN'S CHAIR**

2022 Price List

Pricing Effective February 2022



freshcoast  
by LELAND

**manitou children's chair price list**

---







- + manitou chair: table of contents ..... MTC2
- + manitou chair specification information..... MTC3
- + manitou chair specification example ..... MTC4
- + manitou chair shell art options ..... MTC5-MTC6
- + manitou chair, 12 inch seat height..... MTC7
- + manitou chair, 14 inch seat height..... MTC8
- + manitou chair, 16 inch seat height..... MTC9
- + manitou chair, 15 inch seat height, sled base .... MTC10-MTC11
- + manitou chair, task base ..... MTC12

## model



DESCRIPTION	CODE
manitou children's chair, wood face	MTC
manitou children's chair, wood face, upholstered seat pad	MTCU
manitou children's chair, fully upholstered	MTFU

## shell style

### WOOD SHELL

DESCRIPTION	CODE	DESCRIPTION	CODE
Arch 	AH	Bump 	BP
Dip 	DP	Slant SL 	
Tilt 	TT	Wave 	WV

### FULLY UPHOLSTERED SHELL

DESCRIPTION	CODE	DESCRIPTION	CODE
Bump 	BP	Dip 	DP

## shell finish or color

### TRANSPARENT FINISHES (SEMI-GLOSS SHEEN)

DESCRIPTION	CODE
natural	11
medium	13
neutral	15
classic mahogany	21
white wash II	30
espresso	23
transparent black	29
graphite	25

### SEMI-TRANSPARENT FINISHES (MATTE-SHEEN)

DESCRIPTION	CODE
arctic II	16M
ink II	18M
limelight	33M
caribbean II	48M
soda red	46M
tangerine	40M
ice blue	47M
oxford II	49M
dolphin II	50M

## shell art

Select shell art code from the shell art index [here](#) (pages 5 & 6).  
Shell art is not available on fully upholstered models.

## seat height

### 4-LEG STEEL BASE

DESCRIPTION	CODE
12 inch seat height	SH12
14 inch seat height	SH14
16 inch seat height	SH16

### WIRE SLED BASE

DESCRIPTION	CODE
15 inch seat height	SH15

### TASK BASE

DESCRIPTION	CODE
13-16 inch seat height (task base only)	HATB

Black five star task base on hard casters is height adjustable with tilt.

## base finish

### 4-LEG STEEL AND WIRE SLED

DESCRIPTION	CODE	DESCRIPTION	CODE
sterling	ST	matte gold rush	MGR
warm grey	WG	matte mercury	MMR
cool grey	CG	matte mineral	MMN
black	B	matte burnish	MBN
white	W	matte foundry	MFN
		matte new penny	MNP

### TASK

DESCRIPTION	CODE
black	B

## upholstery

All upholstery is Customer's Own Material (COM).

Due to the design of this product, it is required that all non pre-approved textiles be tested for compatibility. Untested textiles will not be accepted. Contact freshcoast for yardage requirements on textiles with repeats.

Please refer to freshcoast Textile Program which features textiles and leathers from the following partners:

- Camira
- Carnegie
- CF Stinson
- Green Hides
- Maharam
- Unika Vaev

The complete grade list can be found at [www.fc.studio.com/textile-partners](http://www.fc.studio.com/textile-partners) or you can specify COM/COL. Due to the design of this product, it is recommended that all non pre-approved textile be tested for compatibility.

## SPECIFICATIONS REQUIRED TO CREATE THE PRODUCT CODE

---

- + **Model**
- + **Shell Style**
- + **Shell Finish or Color**
- + **Shell Art (when applicable)**
- + **Seat Height**
- + **Base Finish**
- + **Upholstered Seat Pad (when applicable)**

**M T C** - **A H** - **5 1** - **F 0 2 0** - **S H 1 5** - **B** - **UPHOLSTERED SEAT PAD (WHEN APPLICABLE)**  
MODEL SHELL STYLE SHELL FINISH OR COLOR SHELL ART (WHEN APPLICABLE) SEAT HEIGHT BASE FINISH UPHOLSTERED SEAT PAD (WHEN APPLICABLE)

### MODEL

---

Manitou children's chair (MTC)

### SHELL STYLE

Arch (AH)

### SHELL FINISH OR COLOR

Marigold (51)

### SHELL ART

Celestial, Sun (F020)

### SEAT HEIGHT

15 inch seat height (SH15)

### BASE FINISH

Black (B)



### UPHOLSTERED SEAT PAD SELECTION

When applicable

**freshcoast shell art collections**

Please refer to the freshcoast children’s brochure for details on scale and placement of shell art. If no shell art is desired, use code F999.

**swamp things**

grade 1

description  
code



snake  
(F001)



lizard  
(F002)



tree frog  
(F003)

\*cutout is off  
center



turtle  
(F004)

\*cutout is off  
center

**safari**

grade 1

description  
code



rhinoceros  
(F005)



elephant  
(F006)



lioness  
(F007)



ostrich  
(F008)



giraffe  
(F009)

**petroglyphs**

grade 1

description  
code



ram  
(F010)



antelope  
(F011)



deer  
(F012)



caribou  
(F013)



horse  
(F014)

**birds**

grade 2

description  
code



hummingbird  
(F015)



owl  
(F016)



woodpecker  
(F017)



dove  
(F018)

**celestial**

grade 1&2

description  
code



moon  
(F019)



sun  
(F020)  
grade 1



star  
(F021)



saturn  
(F022)



shooting star  
(F023)  
grade 2



moon among stars  
(F024)



**freshcoast shell art collections, continued**

Please refer to the freshcoast children's brochure for details on scale and placement of shell art. If no shell art is desired, use code F999.

**sea life**  
grade 1&2

description  
code

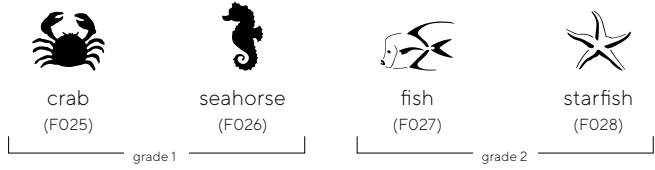

**animal tracks**  
grade 2

description  
code



**shapes**  
grade 1

description  
code

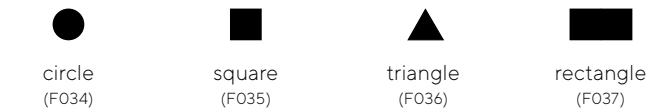

**dinosaurs**  
grade 1

description  
code



**insects**  
grade 1&2

description  
code

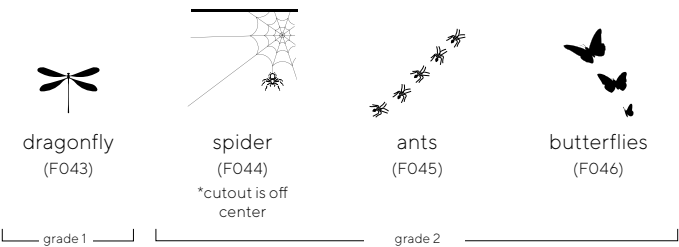

Original artwork is property of freshcoast Inc. All rights reserved. No part of this artwork may be reproduced or transmitted in any form or by any electronic means, including photocopying, or by any information or retrieval system, without written permission from the President or Director of freshcoast, Inc.

12 inch seat height

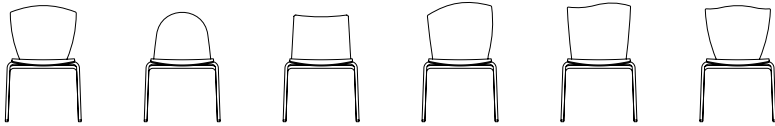

manitou four leg base	model	list price/grade	list
12" seat height, wood back  W16.5 D17.5-19* H24.5-27*	MTC-SH12	plain back	\$427
		grade 1 cutout	\$471
		grade 2 cutout	\$549

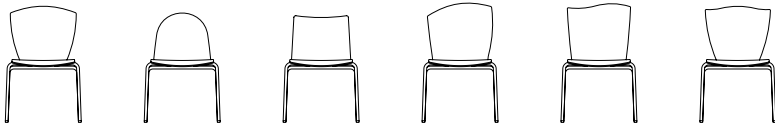

manitou four leg base	model	list price/grade	com/col	a	b	c	d	e	f	g	h	i	j	k	l
12" seat height, upholstered seat pad  W16.5 D17.5-19* H24.5-27*	MTCU-SH12	plain back	\$559	585	598	611	625	638	651	664	677	691	704	717	730
		grade 1 cutout	\$601	628	641	654	667	681	694	707	720	733	747	760	773
		grade 2 cutout	\$680	706	719	732	745	759	772	785	798	811	825	838	851

COM yardage: ½ yd.  
Contact freshcoast customer care for COL requirements, textile testing requirements and yardage requirements for textiles with repeats.

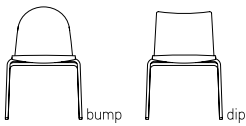

manitou four leg base	model	com/col	a	b	c	d	e	f	g	h	i	j	k	l
12" seat height, upholstered seat pad  BUMP W16.75 D19 H23.5 DIP W16.75 D19 H22	MTFU-SH12	\$568	648	687	727	766	806	846	885	925	964	1004	1043	1083
		COM yardage: 1½ yd. Contact freshcoast customer care for COL requirements, textile testing requirements and yardage requirements for textiles with repeats.												

\* dimension varies based upon the individual shell style

to specify: please refer to pages 3-4 for complete specifying information. Specify all products by their product code.

pricing effective: February 25, 2022 10:25 AM

14 inch seat height

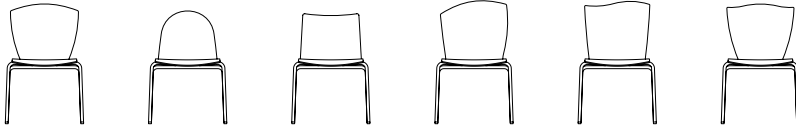

manitou four leg base	model	list price/grade	list
14" seat height, wood back  W16.75 D18.5-20* H26.5-29*	MTC-SH14	plain back	\$430
		grade 1 cutout	\$474
		grade 2 cutout	\$552

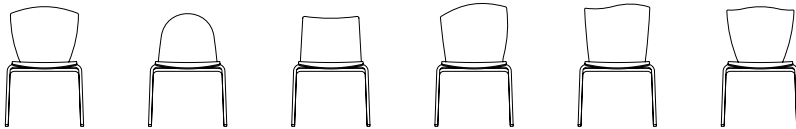

manitou four leg base	model	list price/grade	com/col	a	b	c	d	e	f	g	h	i	j	k	l
14" seat height, upholstered seat pad  W16.75 D18.5-20* H26.5-29*	MTCU-SH14	plain back	\$561	587	600	614	627	640	653	666	680	693	706	719	732
		grade 1 cutout	\$606	632	645	659	672	685	698	711	725	738	751	764	777
		grade 2 cutout	\$685	711	725	738	751	764	777	791	804	817	830	843	857

COM yardage: ½ yd.  
Contact freshcoast customer care for COL requirements, textile testing requirements and yardage requirements for textiles with repeats.

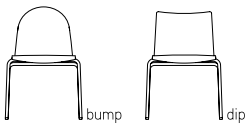

manitou four leg base	model	com/col	a	b	c	d	e	f	g	h	i	j	k	l
14" seat height, fully upholstered  BUMP W16.75 D19 H25.5 DIP W16.75 D19 H24	MTFU-SH14	\$572	651	691	730	770	809	849	888	928	968	1007	1047	1086
		COM yardage: 1½ yd. Contact freshcoast customer care for COL requirements, textile testing requirements and yardage requirements for textiles with repeats.												

\* dimension varies based upon the individual shell style

to specify: please refer to pages 3-4 for complete specifying information. Specify all products by their product code.

pricing effective: February 25, 2022 10:25 AM

16 inch seat height

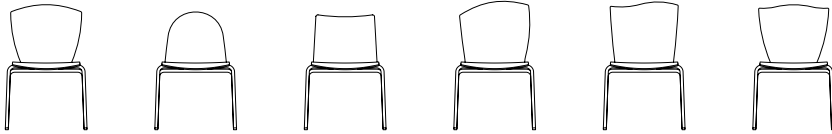

manitou four leg base	model	list price/grade	list
16" seat height, wood back  W17 D19-20.5* H27.5-30*	MTC-SH16	plain back	\$432
		grade 1 cutout	\$477
		grade 2 cutout	\$555

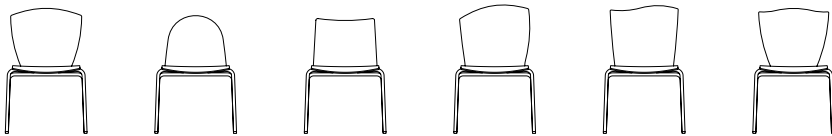

manitou four leg base	model	list price/grade	com/col	a	b	c	d	e	f	g	h	i	j	k	l
16" seat height, upholstered seat pad  W17 D19-20.5* H27.5-30*	MTCU-SH16	plain back	\$563	589	603	616	629	642	655	669	682	695	708	721	734
		grade 1 cutout	\$608	634	648	661	674	687	700	714	727	740	753	766	780
		grade 2 cutout	\$687	714	727	740	753	766	780	793	806	819	832	846	859

COM yardage: ½ yd.  
Contact freshcoast customer care for COL requirements, textile testing requirements and yardage requirements for textiles with repeats.

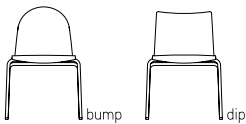

manitou four leg base	model	com/col	a	b	c	d	e	f	g	h	i	j	k	l
16" seat height, fully upholstered  BUMP W16.75 D19 H27.5 DIP W16.75 D19 H26	MTFU-SH16	\$576	655	695	734	774	814	853	893	932	972	1012	1051	1091
		COM yardage: 1½ yd. Contact freshcoast customer care for COL requirements, textile testing requirements and yardage requirements for textiles with repeats.												

\* dimension varies based upon the individual shell style

to specify: please refer to pages 3-4 for complete specifying information. Specify all products by their product code.

pricing effective: February 25, 2022 10:25 AM

15 inch seat height - sled base



manitou sled base	model	list price/grade	list
<b>15" seat height, wood back</b>  W17 D19-20.5* H27.5-30*	MTC-SH15	<b>powder coat base</b>	
		plain back	\$418
		grade 1 cutout	\$462
		grade 2 cutout	\$519



manitou sled base	model	list price/grade	com/col	a	b	c	d	e	f	g	h	i	j	k	l
<b>15" seat height, powdercoat base, upholstered seat pad</b>  W17 D19-20.5* H27.5-30*	MTCU-SH15	<b>powdercoat base</b>													
		plain back	\$549	575	588	601	615	628	641	654	667	681	694	707	720
		grade 1 cutout	\$594	620	633	647	660	673	686	699	712	726	739	752	765
		grade 2 cutout	\$628	654	667	681	694	707	720	733	747	760	773	786	799

COM yardage: 1/2 yd.

Contact freshcoast customer care for COL requirements, textile testing requirements and yardage requirements for textiles with repeats.

\* dimension varies based upon the individual shell style

to specify: please refer to pages 3-4 for complete specifying information. Specify all products by their product code.

pricing effective: February 25, 2022 10:25 AM

15 inch seat height - sled base



**manitou sled base**

model

com/col a b c d e f g h i j k l

**15" seat height,  
wire sled base,  
fully upholstered**

MTFU-SH15	powder coat base	\$527	606	645	685	725	764	804	843	883	923	962	1002	1041
-----------	------------------	-------	-----	-----	-----	-----	-----	-----	-----	-----	-----	-----	------	------

BUMP	W16	D18	H25.5
DIP	W16	D17.5	H24

COM yardage: 1 1/2 yd.

Contact freshcoast customer care for COL requirements, textile testing requirements and yardage requirements for textiles with repeats.

**to specify:** please refer to pages 3-4 for complete specifying information. Specify all products by their product code.

pricing effective: February 25, 2022 10:25 AM

13"-16" adjustable task base chair

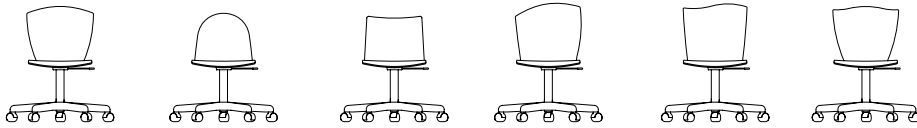

manitou task base	model	list price/grade	list
13-16" adjustable seat height, wood back, task base	MTC-HATB	plain back	\$465
		grade 1 cutout	\$510
		grade 2 cutout	\$543

W22 D22 H\*

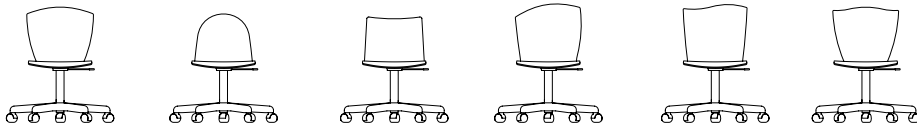

manitou task base	model	list price/grade	com/col	a	b	c	d	e	f	g	h	i	j	k	l
13-16" adjustable seat height, wood back, upholstered seat pad, task base	MTCU-HATB	plain back	\$597	623	637	650	663	676	689	703	716	729	742	755	769
		grade 1 cutout	\$642	669	682	695	708	721	734	748	761	774	787	800	814
		grade 2 cutout	\$675	701	715	728	741	754	767	781	794	807	820	833	847

W16.5 D17.5-19\* H\*

COM yardage: 1/2 yd.

Contact freshcoast customer car for COL requirements, textile testing requirements and yardage requirements for textiles with repeats.

\*varies due to adjustable seat

to specify: please refer to pages 3-4 for complete specifying information. Specify all products by their product code.

freshcoast collection

**MANITOU  
CHILDREN'S TABLE**

202 Price List

Pricing Effective February 2022



freshcoast  
by LELAND



**manitou children's table price list**

---

- + manitou table: table of contents ..... MCT2
- + manitou table specification information ..... MCT3
- + manitou table specification example ..... MCT4
- + manitou table black base ..... MCT5
- + manitou table sterling base ..... MCT6

**model**

DESCRIPTION	CODE
Manitou children's table	MCT

**base finish**

DESCRIPTION	CODE
black	B
sterling	ST

**top size**

ROUND CODE	CODE	SQUARE	CODE	RECTANGLE	
36 dia	36D	36x36	3636	30x60	3060
42 dia	42D	42x42	4242		
48 dia	48D	48x48	4848		

**top surface finish or color**

**WOOD TOP:**

**TRANSPARENT FINISHES (SEMI-GLOSS SHEEN)**

DESCRIPTION	CODE
natural	11
medium	13
neutral	15
classic mahogany	21
white wash II	30
espresso	23
transparent black	29
graphite	25

**SEMI-TRANSPARENT FINISHES (MATTE-SHEEN)**

DESCRIPTION	CODE
arctic II	16M
ink II	18M
limelight	33M
caribbean II	48M
soda red	46M
tangerine	40M
ice blue	47M
oxford II	49M
dolphin II	50M

**top surface finish or color, cont.**

**LAMINATE TOP:**

DESCRIPTION	CODE
Identify manufacturer, laminate code, & color	L

Please refer to the freshcoast Terms and Conditions for a listing of standard laminates. For table pricing in laminates not listed, please contact freshcoast for a quotation.

**edge type**

**SOFT VINYL EDGE:**

DESCRIPTION	CODE
13/16" flat PVC	V2

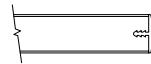

**WOOD EDGE:**

DESCRIPTION	CODE
1" flat plywood	W2

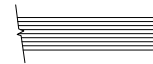

**edge finish or color**

**SOFT VINYL EDGE:**

DESCRIPTION	CODE
black	B
white	W
grey	G

**WOOD EDGE:**

Select from freshcoast Colors

Wood top with wood edge must be specified in the same finish.

Laminate top with wood edge may be specified in any freshcoast finish.

## SPECIFICATIONS REQUIRED TO CREATE THE PRODUCT CODE

- + **Model**
- + **Base Finish**
- + **Top Size**
- + **Top Surface Finish or Color**
- + **Edge Type**
- + **Edge Finish or Color**

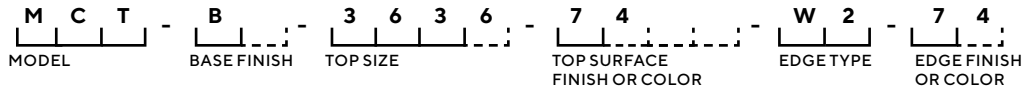

### MODEL

Manitou children's table (MCT)

### BASE FINISH

Black (B)

### TOP SIZE

36 X 36 (3636)

### TOP SURFACE FINISH OR COLOR

Concord (74)

### EDGE TYPE

1 inch flat plywood (W2)

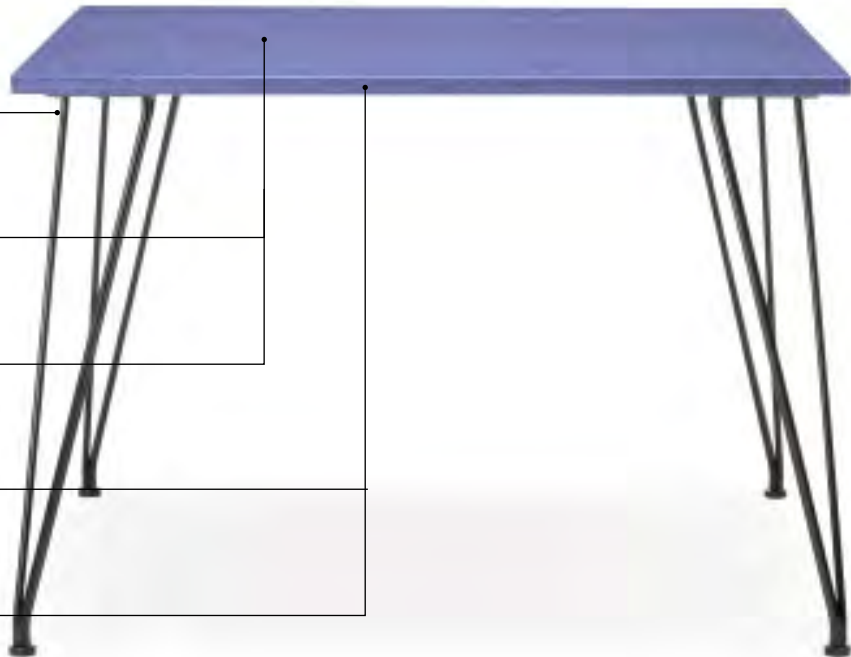

### EDGE FINISH OR COLOR

Concord (74)

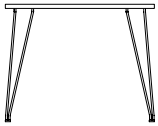

black powder coat base







manitou table	model	top size/code	list price/edge codes	V2	W2
4-leg steel black base H25	MCT-B	<b>wood top</b>			
 round		36 dia – 36D		\$1307	1719
 square		42 dia – 42D		\$1367	1841
 rectangle		48 dia – 48D		\$1687	1861
36 DIA	36 x 36	36 x 36 – 3636		\$1316	1728
42 DIA	42 x 42	42 x 42 – 4242		\$1385	1855
48 DIA	48 x 48	48 x 48 – 4848		\$1714	1889
		30 x 60 – 3060		\$1456	1781
		<b>laminatE top</b>		<b>V6</b>	
		36 dia – 36D		\$1153	1451
		42 dia – 42D		\$1385	1602
		48 dia – 48D		\$1405	1631
		36 x 36 – 3636		\$1167	1466
		42 x 42 – 4242		\$1401	1622
		48 x 48 – 4848		\$1434	1661
		30 x 60 – 3060		\$1297	1478

to specify: please refer to pages 3-4 for complete specifying information. Specify all products by their product code.

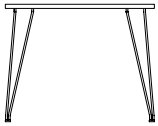
pricing effective: January 25, 2022 4:33 PM

sterling powder coat base



manitou table	model	top size/code	list price/edge codes	V2	W2
4-leg steel sterling base H25	MCT-S	<b>wood top</b>			
 round		36 dia – 36D		\$1443	1855
 square		42 dia – 42D		\$1506	1977
 rectangle		48 dia – 48D		\$1825	2006
36 DIA	36 x 36	36 x 36 – 3636		\$1455	1867
42 DIA	42 x 42	42 x 42 – 4242		\$1522	1993
48 DIA	48 x 48	48 x 48 – 4848		\$1852	2032
		30 x 60 – 3060		\$1594	1920
		<b>laminatE top</b>		<b>V6</b>	
		36 dia – 36D		\$1301	1639
		42 dia – 42D		\$1501	1799
		48 dia – 48D		\$1513	1827
		36 x 36 – 3636		\$1313	1651
		42 x 42 – 4242		\$1534	1818
		48 x 48 – 4848		\$1543	1855
		30 x 60 – 3060		\$1499	1667

to specify: please refer to pages 3-4 for complete specifying information. Specify all products by their product code.

pricing effective: January 25, 2022 4:33 PM

freshcoast collection

**QUINCE  
CHILDREN'S CHAIR**

2022 Price List

Pricing Effective February 2022



freshcoast  
by LELAND

**quince children's chair price list**

---

- + quince chair: table of contents ..... QC2
- + quince chair specification information ..... QC3
- + quince chair specification example..... QC4
- + quince chair shell art..... QC5-QC6
- + quince 12 inch & 14 inch seat height..... QC7
- + quince 16 inch seat height & task base chair .... QC8

### model

DESCRIPTION	CODE
Quince children's chair, wood face	QC
Quince children's chair, wood face, upholstered seat pad	QCU

### shell style

#### WOOD SHELL

DESCRIPTION	CODE	DESCRIPTION	CODE
Horizon	H	Bump	BP

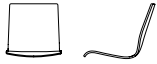

### shell finish

#### TRANSPARENT FINISHES (SEMI-GLOSS SHEEN)

DESCRIPTION	CODE
natural	11
medium	13
neutral	15
classic mahogany	21
espresso	23
white wash II	30
transparent black	29
graphite	25

#### SEMI-TRANSPARENT FINISHES (MATTE-SHEEN)

DESCRIPTION	CODE
arctic ii	16M
ink ii	18M
limelight	33M
caribbean II	48M
soda red	46M
tangerine	40M
ice blue	47M
oxford II	49M
dolphin II	50M

### shell art

Select shell art code from the shell art index [here](#) (pages 5 & 6).

### seat height

DESCRIPTION	CODE
12 inch seat height, wood base	SH12
14 inch seat height, wood base	SH14
16 inch seat height, wood base	SH16
13-16 inch seat height (task base)	HATB

Black five star task base on hard casters is height adjustable with tilt.

### base finish

#### WOOD

select from shell finish colors

#### TASK

DESCRIPTION	CODE
black	B

### upholstered seat pad

Upholstery is Customer's Own Material (COM) requiring ½ yd. per chair.

Due to the design of this product, it is required that all non pre-approved textiles be tested for compatibility. Untested textiles will not be accepted. Contact freshcoast for yardage requirements on textiles with repeats.

Please refer to freshcoast Textile Program which features textiles and leathers from the following partners:

- Camira
- Carnegie
- CF Stinson
- Green Hides
- Maharam
- Unika Vaev

The complete grade list can be found at [www.fc.studio/textile-partners](http://www.fc.studio/textile-partners) or you can specify COM/COL. Due to the design of this product, it is recommended that all non pre-approved textile be tested for compatibility.



## SPECIFICATIONS REQUIRED TO CREATE THE PRODUCT CODE

- + **Model**
- + **Shell Style**
- + **Shell Finish**
- + **Shell Art**
- + **Seat Height**
- + **Base Finish**
- + **Upholstered Seat Pad (when applicable)**

Q C - H - 3 2 M - F 0 1 4 - S H 1 4 - 1 1 - - - -  
MODEL SHELL STYLE SHELL FINISH SHELL ART SEAT HEIGHT BASE FINISH UPHOLSTERED SEAT PAD  
(WHEN APPLICABLE)

### MODEL

Quince children's chair (QC)

### SHELL STYLE

Horizon (H)

### SHELL FINISH

Ink (32M)

### SHELL ART

Petroglyph, Horse (F014)

### SEAT HEIGHT

14 inch seat height (SH14)

### BASE FINISH

Natural (11)



### UPHOLSTERED SEAT PAD SELECTION

When applicable

**freshcoast shell art collections**

Please refer to the freshcoast children’s brochure for details on scale and placement of shell art. If no shell art is desired, use code F999.

**swamp things**  
grade 1

description  
code



snake  
(F001)



lizard  
(F002)



tree frog  
(F003)  
\*cutout is off  
center



turtle  
(F004)  
\*cutout is off  
center

**safari**  
grade 1

description  
code



rhinoceros  
(F005)



elephant  
(F006)



lioness  
(F007)



ostrich  
(F008)



giraffe  
(F009)

**petroglyphs**  
grade 1

description  
code



ram  
(F010)



antelope  
(F011)



deer  
(F012)



caribou  
(F013)



horse  
(F014)

**birds**  
grade 2

description  
code



hummingbird  
(F015)



owl  
(F016)



woodpecker  
(F017)



dove  
(F018)

**celestial**  
grade 1&2

description  
code



moon  
(F019)



sun  
(F020)  
grade 1



star  
(F021)



saturn  
(F022)



shooting star  
(F023)  
grade 2



moon among stars  
(F024)

Original artwork is property of freshcoast Inc. All rights reserved. No part of this artwork may be reproduced or transmitted in any form or by any electronic means, including photocopying, or by any information or retrieval system, without written permission from the President or Director of freshcoast, Inc.

**freshcoast shell art collections, continued**

Please refer to the freshcoast children's brochure for details on scale and placement of shell art. If no shell art is desired, use code F999.

**sea life**  
grade 1&2

description  
code

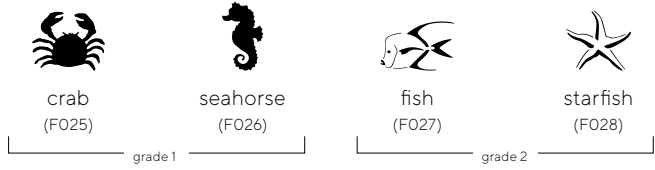

**animal tracks**  
grade 2

description  
code

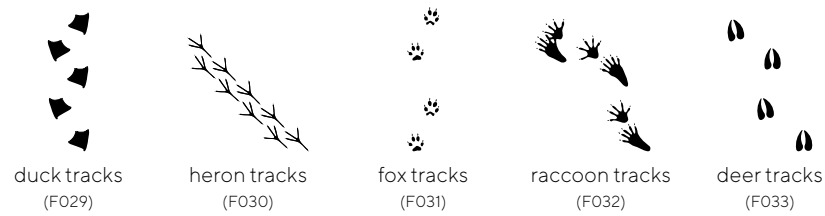

**shapes**  
grade 1

description  
code

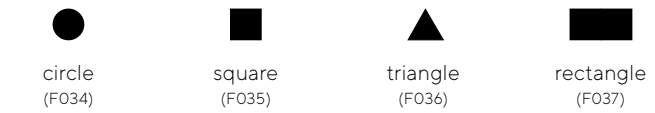

**dinosaurs**  
grade 1

description  
code



**insects**  
grade 1&2

description  
code

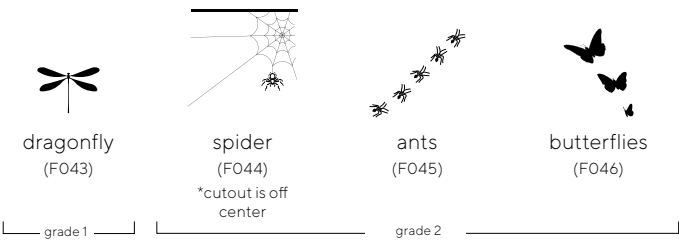

Original artwork is property of freshcoast Inc. All rights reserved. No part of this artwork may be reproduced or transmitted in any form or by any electronic means, including photocopying, or by any information or retrieval system, without written permission from the President or Director of freshcoast, Inc.

12 inch & 14 inch seat height

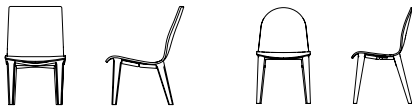

quince	model	list price/grade	list
12" children's chair, wood shell W15.5 D16.5 H23 SH12	QC-SH12	plain back	\$518
		grade 1 cutout	\$561
		grade 2 cutout	\$596

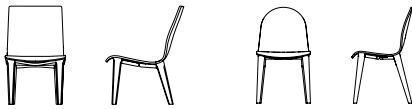

quince	model	list price/grade	com/col	a	b	c	d	e	f	g	h	i	j	k	l
12" children's chair, wood shell upholstered seat pad W15.5 D16.5 H23 SH12	QCU-SH12	plain back	\$649	675	688	701	715	728	741	754	767	781	794	807	820
		grade 1 cutout	\$693	719	732	745	759	772	785	798	811	825	838	851	864
		grade 2 cutout	\$727	753	766	780	793	806	819	832	846	859	872	885	898

COM yardage: ½ yd.  
Contact freshcoast customer care for COL requirements, textile testing requirements and yardage requirements for textiles with repeats.



quince	model	list price/grade	list
14" children's chair, wood shell W16.75 D16.75 H25 SH14	QC-SH14	plain back	\$552
		grade 1 cutout	\$596
		grade 2 cutout	\$631

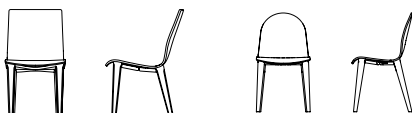

quince	model	list price/grade	com/col	a	b	c	d	e	f	g	h	i	j	k	l
14" children's chair, wood shell upholstered seat pad W16.75 D16.75 H25 SH14	QCU-SH14	plain back	\$685	711	725	738	751	764	777	791	804	817	830	843	857
		grade 1 cutout	\$727	753	766	780	793	806	819	832	846	859	872	885	898
		grade 2 cutout	\$763	789	803	816	829	842	855	869	882	895	908	921	935

COM yardage: ½ yd.  
Contact freshcoast customer care for COL requirements, textile testing requirements and yardage requirements for textiles with repeats.

to specify: please refer to pages 3-4 for complete specifying information. Specify all products by their product code.

pricing effective: February 25, 2022 10:33 AM

16 inch seat height & 13"-16" adjustable task base chair



quince	model	list price/grade	list
16" children's chair, wood shell W16 D17 H27 SH16	QC-SH16	plain back	\$587
		grade 1 cutout	\$631
		grade 2 cutout	\$665

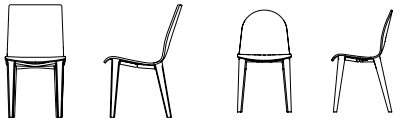

quince	model	list price/grade	com/col	a	b	c	d	e	f	g	h	i	j	k	l
16" children's chair, wood shell upholstered seat pad W16 D17 H27 SH16	QCU-SH16	plain back	\$718	744	758	771	784	797	810	824	837	850	863	876	890
		grade 1 cutout	\$763	789	803	816	829	842	855	869	882	895	908	921	935
		grade 2 cutout	\$796	822	836	849	862	875	888	902	915	928	941	954	968

COM yardage: ½ yd.

Contact freshcoast customer care for COL requirements, textile testing requirements and yardage requirements for textiles with repeats.

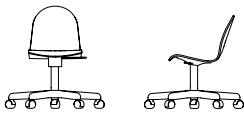

quince	model	list price/grade	list
13"-16" adjustable seat height, wood shell, task base W16.25 D16.25 H24	QC-HATB	plain back	\$617
		grade 1 cutout	\$662
		grade 2 cutout	\$696

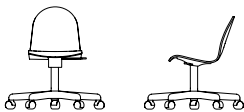

bow	model	list price/grade	com/col	a	b	c	d	e	f	g	h	i	j	k	l
13"-16" adjustable seat height, wood shell, upholstered seat pad, task base W16.25 D16.25 H24	QCU-HATB	plain back	\$749	775	788	802	815	828	841	854	868	881	894	907	920
		grade 1 cutout	\$792	818	831	844	858	871	884	897	910	924	937	950	963
		grade 2 cutout	\$827	853	866	880	893	906	919	932	946	959	972	985	998

COM yardage: ½ yd.

Contact freshcoast customer care for COL requirements, textile testing requirements and yardage requirements for textiles with repeats.

to specify: please refer to pages 3-4 for complete specifying information. Specify all products by their product code.

freshcoast collection

**QUINCE  
CHILDREN'S TABLE**

2022 Price List

Pricing Effective February 2022



freshcoast  
by LELAND

**quince children's table** price list

---

- + quince table: table of contents..... QCT2
- + quince table specification information ..... QCT3
- + quince table specification example..... QCT4
- + quince 20"H table ..... QCT5
- + quince 22"H table..... QCT6
- + quince 25"H table..... QCT7

**model**

DESCRIPTION	CODE
Quince children's table	QCT

**table height**

DESCRIPTION	CODE
20 inch table height	20H
22 inch table height	22H
25 inch table height	25H

**top size**

ROUND CODE	CODE	SQUARE	CODE	RECTANGLE	CODE
36 dia	36D	36x36	3636	30x60	3060
42 dia	42D	42x42	4242		
48 dia	48D	48x48	4848		

**top surface finish or color**

**WOOD TOP:**

**TRANSPARENT FINISHES (SEMI-GLOSS SHEEN)**

DESCRIPTION	CODE
natural	11
medium	13
neutral	15
classic mahogany	21
espresso	23
white wash II	30
transparent black	29
graphite	25

**SEMI-TRANSPARENT FINISHES (MATTE-SHEEN)**

DESCRIPTION	CODE
arctic ii	16M
ink ii	18M
limelight	33M
caribbean II	48M
soda red	46M
tangerine	40M
ice blue	47M
oxford II	49M
dolphin II	50M

**top surface finish or color, cont.**

**LAMINATE TOP:**

DESCRIPTION	CODE
Identify manufacturer, laminate code, & color	L

Please refer to the freshcoast Terms and Conditions for a listing of standard laminates. For table pricing in laminates not listed, please contact freshcoast for a quotation.

**edge type**

**SOFT VINYL EDGE:**

DESCRIPTION	CODE
13/16" flat PVC	V2



**WOOD EDGE:**

DESCRIPTION	CODE
1" flat plywood	W2



**edge finish or color**

**SOFT VINYL EDGE:**

DESCRIPTION	CODE
black	B
white	W
grey	G

**WOOD EDGE:**

Select from top surface colors

Wood top with wood edge must be specified in the same finish.

Laminate top with wood edge may be specified in any freshcoast finish

**base finish**

Select from top surface colors



## SPECIFICATIONS REQUIRED TO CREATE THE PRODUCT CODE

- + **Model**
- + **Table Height**
- + **Base Finish**
- + **Top Size**
- + **Top Surface Finish or Color**
- + **Edge Type**
- + **Edge Finish or Color**

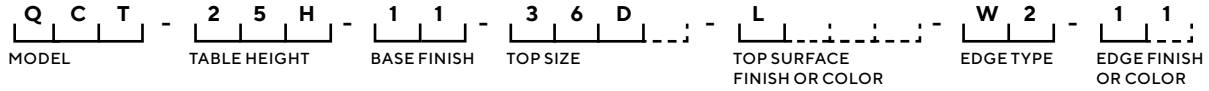

### MODEL

Quince children's table (QCT)

### TABLE HEIGHT

25 inch table height (25H)

### BASE FINISH

Natural (11)

### TOP SIZE

36 dia (36D)

### TOP SURFACE FINISH OR COLOR

Laminate (L)

### EDGE TYPE

1 inch flat plywood (W2)



### EDGE FINISH OR COLOR

Natural (11)



20 inch height





quince table	model	top size/code	list price/edge codes	V2	W2
wood base H20	QCT-20H	wood top			
 round		36 dia – 36D		\$1079	1348
 square		42 dia – 42D		\$1135	1421
 rectangle		48 dia – 48D		\$1152	1439
36 DIA	36 x 36	36 x 36 – 3636		\$1084	1356
42 DIA	42 x 42	42 x 42 – 4242		\$1140	1427
48 DIA	48 x 48	48 x 48 – 4848		\$1158	1446
		30 x 60 – 3060		\$1115	1393
		laminate top			
		36 dia – 36D		\$971	1212
		42 dia – 42D		\$1021	1278
		48 dia – 48D		\$1036	1295
		36 x 36 – 3636		\$975	1219
		42 x 42 – 4242		\$1026	1284
		48 x 48 – 4848		\$1045	1305
		30 x 60 – 3060		\$1005	1255

to specify: please refer to pages 3-4 for complete specifying information. Specify all products by their product code.

22 inch height



quince table	model	top size/code	list price/edge codes	V2	W2
wood base H22	QCT-22H	wood top			
 round		36 dia – 36D		\$1098	1373
 square		42 dia – 42D		\$1158	1446
 rectangle		48 dia – 48D		\$1175	1469
36 DIA	36 x 36	36 x 36 – 3636		\$1105	1383
42 DIA	42 x 42	42 x 42 – 4242		\$1165	1456
48 DIA	48 x 48	48 x 48 – 4848		\$1181	1477
		30 x 60 – 3060		\$1137	1423
		laminate top			
		36 dia – 36D		\$988	1237
		42 dia – 42D		\$1045	1305
		48 dia – 48D		\$1058	1321
		36 x 36 – 3636		\$995	1244
		42 x 42 – 4242		\$1049	1311
		48 x 48 – 4848		\$1062	1329
		30 x 60 – 3060		\$1023	1280



to specify: please refer to pages 3-4 for complete specifying information. Specify all products by their product code.

pricing effective: January 25, 2022 4:51 PM

**QCT6**

25 inch height



quince table		model	top size/code	list price/edge codes	V2	W2
wood base		QCT-25H	wood top			
H25			36 dia – 36D		\$1122	1401
			42 dia – 42D		\$1181	1477
round	square		48 dia – 48D		\$1198	1499
			36 x 36 – 3636		\$1128	1411
36 DIA	36 x 36		42 x 42 – 4242		\$1187	1484
	rectangle		48 x 48 – 4848		\$1204	1506
36 DIA	30 x 60		30 x 60 – 3060		\$1159	1448
42 DIA			laminate top			
48 DIA			36 dia – 36D		\$1009	1260
			42 dia – 42D		\$1062	1329
			48 dia – 48D		\$1079	1349
			36 x 36 – 3636		\$1015	1269
			42 x 42 – 4242		\$1070	1335
		48 x 48 – 4848		\$1085	1356	
		30 x 60 – 3060		\$1046	1306	

to specify: please refer to pages 3-4 for complete specifying information. Specify all products by their product code.

freshcoast collection  
**ZOON**  
**CHILDREN'S CHAIR**

2022 Price List

Pricing Effective February 2022



fc

freshcoast

by LELAND

**zoon children's chair price list**

---

- + zoon chair: table of contents ..... ZNC2
- + zoon chair specification information..... ZNC3
- + zoon chair specification example ..... ZNC4
- + zoon chair art..... ZNC5-ZNC6
- + zoon 12 inch & 14 inch seat height chair..... ZNC7
- + zoon 16 inch seat height & task base chair..... ZNC8

## model

DESCRIPTION	CODE
Zoon children's chair, wood face	ZNC
Zoon children's chair, upholstered seat pad	ZNCU

## shell style

DESCRIPTION	CODE	DESCRIPTION	CODE
Round	R	Square	S
			

## shell finish

FRESHCOAST TRANSPARENT FINISHES (SEMI-GLOSS SHEEN)		FRESHCOAST SEMI-TRANSPARENT FINISHES (MATTE-SHEEN)	
DESCRIPTION	CODE	DESCRIPTION	CODE
natural	11	arctic ii	16M
medium	13	ink ii	18M
neutral	15	limelight	33M
classic mahogany	21	caribbean II	48M
espresso	23	soda red	46M
white wash II	30	tangerine	40M
transparent black	29	ice blue	47M
graphite	25	oxford II	49M
		dolphin II	50M

## shell art

Select shell art code from the shell art index **here** (pages 5 & 6).  
**insects, spider (FO44) is not available on round shells.**

## seat height

DESCRIPTION	CODE
12 inch seat height, steel four leg	SH12
14 inch seat height, steel four leg	SH14
16 inch seat height, steel four leg	SH16
13-16 inch seat height (task base only)	HATB

Black five star task base on hard casters is height adjustable with tilt.

## base finish

### STEEL FOUR LEG

DESCRIPTION	CODE	DESCRIPTION	CODE
sterling	ST	matte gold rush	MGR
warm grey	WG	matte mercury	MMR
cool grey	CG	matte mineral	MMN
black	B	matte burnish	MBN
white	W	matte foundry	MFN
black textured	BT	soda red textured	SRT
grey textured	GT	tangerine textured	TNT
white textured	WT	ice blue textured	IBT
dolphin textured	DLT	arctic textured	ART
oxford textured	OXT	caribbean textured	CBT
ink textured	INT	limelight textured	LLT

### TASK

DESCRIPTION	CODE
black	B

### glide color

DESCRIPTION	CODE
red	R
yellow	Y
blue	BL
grey	G
black	B

## upholstered seat pad

Upholstery is Customer's Own Material (COM) requiring ½ yd. per chair.

Due to the design of this product, it is required that all non pre-approved textiles be tested for compatibility. Untested textiles will not be accepted. Contact freshcoast for yardage requirements on textiles with repeats.

Please refer to freshcoast Textile Program which features textiles and leathers from the following partners:

- Camira
- Carnegie
- CF Stinson
- Green Hides
- Maharam
- Unika Vaev

The complete grade list can be found at [www.fc.studio/textile-partners](http://www.fc.studio/textile-partners) or you can specify COM/COL. Due to the design of this product, it is recommended that all non pre-approved textile be tested for compatibility.

## SPECIFICATIONS REQUIRED TO CREATE THE PRODUCT CODE

- + Model
- + Shell Style
- + Shell Finish
- + Shell Art (when applicable)
- + Seat Height
- + Base Finish
- + Glide Color (when applicable)
- + Upholstered Seat Pad (when applicable)



### MODEL

Zoon children's chair (ZNC)

### SHELL STYLE

Square (S)

### SHELL FINISH

Natural (11)

### SHELL ART

Celestial, Saturn (F022)

### SEAT HEIGHT

14 inch seat height (SH14)

### BASE FINISH

White (W)

### GLIDE COLOR

Yellow (Y)



**UPHOLSTERED SEAT PAD SELECTION**  
When applicable



**freshcoast shell art collections**

Please refer to the freshcoast children's brochure for details on scale and placement of shell art. If no shell art is desired, use code F999.

**swamp things**  
grade 1

description  
code



snake  
(F001)



lizard  
(F002)



tree frog  
(F003)  
\*cutout is off  
center



turtle  
(F004)  
\*cutout is off  
center

**safari**  
grade 1

description  
code



rhinoceros  
(F005)



elephant  
(F006)



lioness  
(F007)



ostrich  
(F008)



giraffe  
(F009)

**petroglyphs**  
grade 1

description  
code



ram  
(F010)



antelope  
(F011)



deer  
(F012)



caribou  
(F013)



horse  
(F014)

**birds**  
grade 2

description  
code



hummingbird  
(F015)



owl  
(F016)



woodpecker  
(F017)



dove  
(F018)

**celestial**  
grade 1&2

description  
code



moon  
(F019)



sun  
(F020)  
grade 1



star  
(F021)



saturn  
(F022)



shooting star  
(F023)  
grade 2



moon among stars  
(F024)

Original artwork is property of freshcoast Inc. All rights reserved. No part of this artwork may be reproduced or transmitted in any form or by any electronic means, including photocopying, or by any information or retrieval system, without written permission from the President or Director of freshcoast, Inc.

**freshcoast shell art collections, continued**

Please refer to the freshcoast children's brochure for details on scale and placement of shell art. If no shell art is desired, use code F999.

**sea life**  
grade 1&2

description  
code

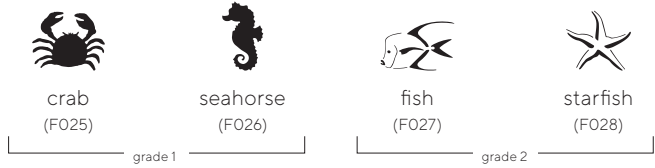

**animal tracks**  
grade 2

description  
code



**shapes**  
grade 1

description  
code

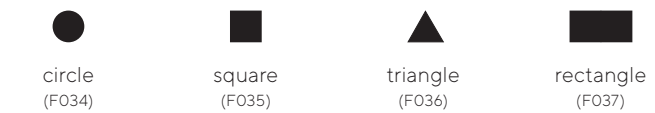

**dinosaurs**  
grade 1

description  
code



**insects**  
grade 1&2

description  
code

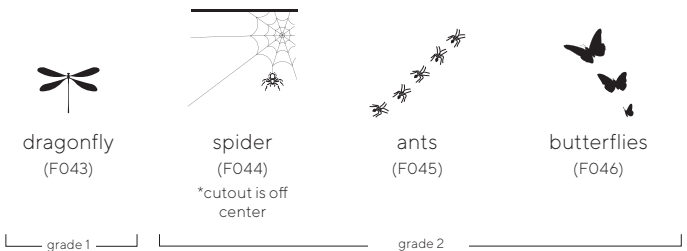

Original artwork is property of freshcoast Inc. All rights reserved. No part of this artwork may be reproduced or transmitted in any form or by any electronic means, including photocopying, or by any information or retrieval system, without written permission from the President or Director of freshcoast, Inc.

12 inch & 14 inch seat height



zoon	model	list price/grade	list
<b>12" children's chair, wood shell</b> ROUND W17.25 D16.25 H26.25 SH12 SQUARE W17.25 D16.25 H24.75 SH12	ZNC	plain back	\$356
		grade 1 cutout	\$401
		grade 2 cutout	\$435



zoon	model	list price/grade	com/col	a	b	c	d	e	f	g	h	i	j	k	l
<b>12" children's chair, wood shell upholstered seat pad</b> ROUND W17.25 D16.25 H26.25 SH12 SQUARE W17.25 D16.25 H24.75 SH12	ZNCU	plain back	\$460	486	499	512	526	539	552	565	578	592	605	618	631
		grade 1 cutout	\$502	529	542	555	568	582	595	608	621	634	648	661	674
		grade 2 cutout	\$538	564	577	590	604	617	630	643	656	670	683	696	709

COM yardage: 1/2 yd.

Contact freshcoast customer care for COL requirements, textile testing requirements and yardage requirements for textiles with repeats.



zoon	model	list price/grade	list
<b>14" children's chair, wood shell</b> ROUND W17.5 D16.5 H28.25 SH14 SQUARE W17.5 D16.5 H26.75 SH14	ZNC	plain back	\$383
		grade 1 cutout	\$427
		grade 2 cutout	\$462



zoon	model	list price/grade	com/col	a	b	c	d	e	f	g	h	i	j	k	l
<b>14" children's chair, wood shell upholstered seat pad</b> ROUND W17.5 D16.5 H28.25 SH14 SQUARE W17.5 D16.5 H26.75 SH14	ZNCU	plain back	\$487	513	527	540	553	566	579	593	606	619	632	645	659
		grade 1 cutout	\$531	557	571	584	597	610	623	637	650	663	676	689	703
		grade 2 cutout	\$566	593	606	619	632	645	659	672	685	698	711	725	738

COM yardage: 1/2 yd.

Contact freshcoast customer care for COL requirements, textile testing requirements and yardage requirements for textiles with repeats.

to specify: please refer to pages 3-4 for complete specifying information. Specify all products by their product code.

16 inch seat height & 13"-16" adjustable task base chair

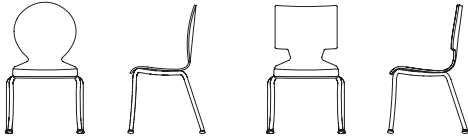

curve	model	list price/grade	list
<b>16" children's chair, wood shell</b> ROUND W17.75 D16.75 H30.25 SH16 SQUARE W17.75 D16.75 H28.75 SH16	ZNC	plain back	\$420
		grade 1 cutout	\$464
		grade 2 cutout	\$498

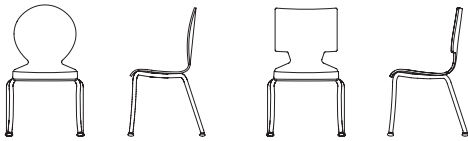

curve	model	list price/grade	com/col	a	b	c	d	e	f	g	h	i	j	k	l
<b>16" children's chair, wood shell upholstered seat pad</b> ROUND W17.75 D16.75 H30.25 SH16 SQUARE W17.75 D16.75 H28.75 SH16	ZNCU	plain back	\$523	550	563	576	589	603	616	629	642	655	669	682	695
		grade 1 cutout	\$568	595	608	621	634	648	661	674	687	700	714	727	740
		grade 2 cutout	\$601	628	641	654	667	681	694	707	720	733	747	760	773

COM yardage: 1/2 yd.  
 Contact freshcoast customer care for COL requirements, textile testing requirements and yardage requirements for textiles with repeats.

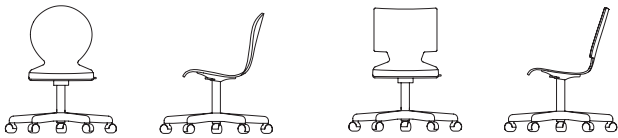

bow	model	list price/grade	list
<b>13"-16" adjustable seat height, wood shell, task base</b> ROUND W22 D22 H27.25-30.25 SQUARE W22 D22 H25.75-28.75	ZNC	plain back	\$488
		grade 1 cutout	\$532
		grade 2 cutout	\$567

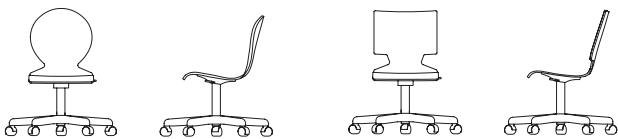

bow	model	list price/grade	com/col	a	b	c	d	e	f	g	h	i	j	k	l
<b>13"-16" adjustable seat height, wood shell, upholstered seat pad, task base</b> ROUND W22 D22 H27.25-30.25 SQUARE W22 D22 H25.75-28.75	ZNCU	plain back	\$590	617	630	643	656	670	683	696	709	722	736	749	762
		grade 1 cutout	\$636	662	675	688	701	715	728	741	754	767	781	794	807
		grade 2 cutout	\$669	695	708	721	734	748	761	774	787	800	814	827	840

COM yardage: 1/2 yd.  
 Contact freshcoast customer care for COL requirements, textile testing requirements and yardage requirements for textiles with repeats.

to specify: please refer to pages 3-4 for complete specifying information. Specify all products by their product code.

freshcoast collection  
**ZOON**  
**CHILDREN'S STOOL**

2022 Price List

Pricing Effective February 2022



freshcoast  
by LELAND

**zoon children's stool price list**

---

- + zoon stool: table of contents ..... ZNS2
- + zoon stool specification information ..... ZNS3
- + zoon stool specification example ..... ZNS4
- + zoon 12 inch & 14 inch seat height stool..... ZNS5
- + zoon 16 inch seat height stool ..... ZNS6

### model

DESCRIPTION	CODE
Zoon stool	ZNS

### seat height

DESCRIPTION	CODE
12 inch seat height, steel four leg	SH12
14 inch seat height, steel four leg	SH14
16 inch seat height, steel four leg	SH16

### base finish

DESCRIPTION	CODE	DESCRIPTION	CODE
sterling	ST	matte gold rush	MGR
warm grey	WG	matte mercury	MMR
cool grey	CG	matte mineral	MMN
black	B	matte burnish	MBN
white	W	matte foundry	MFN
black textured	BT	soda red textured	SRT
grey textured	GT	tangerine textured	TNT
white textured	WT	ice blue textured	IBT
dolphin textured	DLT	arctic textured	ART
oxford textured	OXT	caribbean textured	CBT
ink textured	INT	limelight textured	LLT

### seat finish or color

#### WOOD SEAT:

#### FRESHCOAST TRANSPARENT FINISHES (SEMI-GLOSS SHEEN)

DESCRIPTION	CODE
natural	11
medium	13
neutral	15
classic mahogany	21
espresso	23
white wash II	30
transparent black	29
graphite	25

#### FRESHCOAST SEMI-TRANSPARENT FINISHES (MATTE-SHEEN)

DESCRIPTION	CODE
arctic ii	16M
ink ii	18M
limelight	33M
caribbean II	48M
soda red	46M
tangerine	40M
ice blue	47M
oxford II	49M
dolphin II	50M

### seat finish or color, cont.

#### LAMINATE SEAT:

DESCRIPTION	CODE
Identify manufacturer, laminate code, & color	L

Please refer to the freshcoast Terms and Conditions for a listing of standard laminates. For table pricing in laminates not listed, please contact freshcoast for a quotation.

#### UPHOLSTERED SEAT:

DESCRIPTION	CODE
Customer's Own Material	COM

Upholstery is Customer's Own Material (COM) requiring ½ yd. per chair.

Due to the design of this product, it is required that all non pre-approved textiles be tested for compatibility. Untested textiles will not be accepted. Contact freshcoast for yardage requirements on textiles with repeats.

Please refer to freshcoast Textile Program which features textiles and leathers from the following partners:

- Brentano
- Camira
- Carnegie
- CF Stinson
- Green Hides
- Maharam
- Unika Vaev

The complete grade list can be found at [www.fc.studio/textile-partners](http://www.fc.studio/textile-partners) or you can specify COM/COL. Due to the design of this product, it is recommended that all non pre-approved textile be tested for compatibility.

### edge type

#### WOOD EDGE:

DESCRIPTION	CODE
1" flat plywood	W2



\*upholstered seat does not require an edge selection

### edge finish or color

Select from freshcoast Colors I & II.

Wood seat with wood edge must be specified in the same finish.

Laminate seat with wood edge may be specified in any freshcoast finish

### glide color

DESCRIPTION	CODE
red	R
yellow	Y
blue	BL
grey	G
black	B

## SPECIFICATIONS REQUIRED TO CREATE THE PRODUCT CODE

- + **Model**
- + **Seat Height**
- + **Base Finish**
- + **Seat Finish / Color / Upholstery**
- + **Edge Type (when applicable)**
- + **Edge Finish or Color (when applicable)**
- + **Glide Color**



### MODEL

Zoon stool (ZNS)

### SEAT HEIGHT

16 inch seat height (SH16)

### BASE FINISH

White (W)

### SEAT FINISH / COLOR / UPHOLSTERY

Upholstered (COM)

### EDGE TYPE

When applicable

### EDGE FINISH OR COLOR

When applicable

### GLIDE COLOR

Red (R)





12 inch & 14 inch seat height

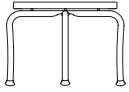

zoon stool	model	list price/grade	list price/edge codes	W2
12 inch seat height, steel four leg base	ZNS-SH12	wood seat		\$281
		laminate seat		\$287

W17.5 D17.5 H12

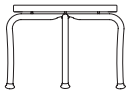

zoon stool	model	list price/grade	com/col	a	b	c	d	e	f	g	h	i	j	k	l
12 inch seat height, steel four leg base, upholstered seat	ZNS-SH12	upholstered seat	\$384	410	423	437	450	463	476	489	502	516	529	542	555
		COM yardage: ½ yd. Contact freshcoast customer care for COL requirements, textile testing requirements and yardage requirements for textiles with repeats.													

W17.5 D17.5 H12

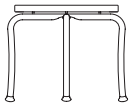

zoon stool	model	list price/grade	list price/edge codes	W2
12 inch seat height, steel four leg base	ZNS-SH14	wood seat		\$290
		laminate seat		\$295

W17.8 D17.8 H14

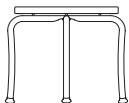

zoon stool	model	list price/grade	com/col	a	b	c	d	e	f	g	h	i	j	k	l
12 inch seat height, steel four leg base, upholstered seat	ZNS-SH14	upholstered seat	\$394	420	433	446	460	473	486	499	512	526	539	552	565
		COM yardage: ½ yd. Contact freshcoast customer care for COL requirements, textile testing requirements and yardage requirements for textiles with repeats.													

W17.8 D17.8 H14

to specify: please refer to pages 3-4 for complete specifying information. Specify all products by their product code.

16 inch seat height

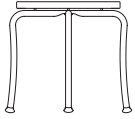

zoon stool	model	list price/grade	list price/edge codes	W2
16 inch seat height, steel four leg base	ZNS-SH16	wood seat		\$299
		laminated seat		\$301

W18.35 D18.35 H16



zoon stool	model	list price/grade	com/col	a	b	c	d	e	f	g	h	i	j	k	l
16 inch seat height, steel four leg base, upholstered seat	ZNS-SH16	upholstered seat	\$402	429	442	455	468	482	495	508	521	534	548	561	574

W18.35 D18.35 H16

COM yardage: 1/2 yd.

Contact freshcoast customer care for COL requirements, textile testing requirements and yardage requirements for textiles with repeats.

freshcoast collection  
**ZOON  
CHILDREN'S TABLE**

2022 Price List

Pricing Effective February 2022



freshcoast  
by LELAND

**zoon children's table price list**

---

- + zoon table: table of contents ..... ZNT2
- + zoon table specification information ..... ZNT3
- + zoon table specification example ..... ZNT4
- + zoon tables ..... ZNT5

**model**

DESCRIPTION	CODE
Zoon children's table	ZNT

**table height**

DESCRIPTION	CODE
20 inch table height	20H
22 inch table height	22H
25 inch table height	25H

**base finish**

DESCRIPTION	CODE	DESCRIPTION	CODE
sterling	ST	matte gold rush	MGR
warm grey	WG	matte mercury	MMR
cool grey	CG	matte mineral	MMN
black	B	matte burnish	MBN
white	W	matte foundry	MFN
black textured	BT	soda red textured	SRT
grey textured	GT	tangerine textured	TNT
white textured	WT	ice blue textured	IBT
dolphin textured	DLT	arctic textured	ART
oxford textured	OXT	caribbean textured	CBT
ink textured	INT	limelight textured	LLT

**top size**

ROUND CODE	CODE	SQUARE	CODE	RECTANGLE	CODE
36 dia	36D	36x36	3636	30x60	3060
42 dia	42D	42x42	4242		
48 dia	48D	48x48	4848		

**top surface finish or color**

**WOOD TOP:**

**FRESHCOAST TRANSPARENT FINISHES (SEMI-GLOSS SHEEN)**

DESCRIPTION	CODE
natural	11
medium	13
neutral	15
classic mahogany	21
espresso	23
white wash II	30
transparent black	29
graphite	25

**FRESHCOAST SEMI-TRANSPARENT FINISHES (MATTE-SHEEN)**

DESCRIPTION	CODE
arctic ii	16M
ink ii	18M
limelight	33M
caribbean II	48M
soda red	46M
tangerine	40M
ice blue	47M
oxford II	49M
dolphin II	50M

**top surface finish or color, cont.**

**LAMINATE TOP:**

DESCRIPTION	CODE
Identify manufacturer, laminate code, & color	L

Please refer to the freshcoast Terms and Conditions for a listing of standard laminates. For table pricing in laminates not listed, please contact freshcoast for a quotation.

**edge type**

**SOFT VINYL EDGE:**

DESCRIPTION	CODE
13/16" flat PVC	V2



**WOOD EDGE:**

DESCRIPTION	CODE
1" flat plywood	W2



**edge finish or color**

**SOFT VINYL EDGE:**

DESCRIPTION	CODE
black	B
white	W
grey	G
red	R
blue	BL
yellow	Y

**WOOD EDGE:**

Select from freshcoast Colors I & II.

Wood top with wood edge must be specified in the same finish.

Laminate top with wood edge may be specified in any freshcoast finish

**glide color**

DESCRIPTION	CODE
red	R
yellow	Y
blue	BL
cool grey	CG
black	B

## SPECIFICATIONS REQUIRED TO CREATE THE PRODUCT CODE

- + **Model**
- + **Table Height**
- + **Base Finish**
- + **Top Size**
- + **Top Surface Finish or Color**
- + **Edge Type**
- + **Edge Finish or Color**
- + **Glide Color**

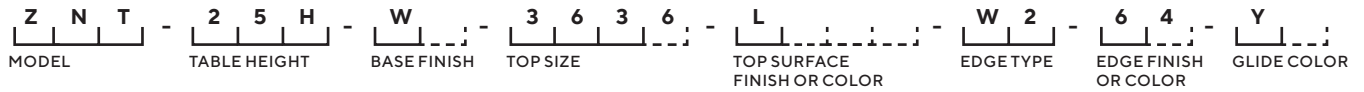

### MODEL

Zoon children's table (ZNT)

### TABLE HEIGHT

25 inch table height (25H)

### BASE FINISH

White (W)

### TOP SIZE

36 dia (36D)

### TOP SURFACE FINISH OR COLOR

Laminate (L)

### EDGE TYPE

1 inch flat plywood (W2)

### EDGE FINISH OR COLOR

Sunflower (64)



### GLIDE COLOR

Yellow (Y)



20 inch height





zoon table		model	top size/code	list price/edge codes	V2	W2
<b>steel base</b>		ZNT-20H	<b>wood top</b>			
H20			36 dia – 36D		\$1217	1522
			42 dia – 42D		\$1275	1594
round	square		48 dia – 48D		\$1292	1616
			36 x 36 – 3636		\$1225	1529
36 DIA	36 x 36		42 x 42 – 4242		\$1282	1601
	rectangle		48 x 48 – 4848		\$1297	1623
42 DIA	42 x 42		30 x 60 – 3060		\$1255	1568
48 DIA	48 x 48					
			<b>laminite top</b>			
			36 dia – 36D		\$1035	1294
			42 dia – 42D		\$1085	1356
			48 dia – 48D		\$1097	1372
			36 x 36 – 3636		\$1040	1300
			42 x 42 – 4242		\$1090	1361
			48 x 48 – 4848		\$1103	1379
			30 x 60 – 3060		\$1065	1333

**to specify:** please refer to pages 3–4 for complete specifying information. Specify all products by their product code.

pricing effective: August 3, 2022 4:04 PM

22 inch height



zoon table		model	top size/code	list price/edge codes	V2	W2
<b>steel base</b>		ZNT-22H	<b>wood top</b>			
H22			36 dia – 36D		\$1249	1559
			42 dia – 42D		\$1308	1633
round	square		48 dia – 48D		\$1324	1657
			36 x 36 – 3636		\$1255	1568
36 DIA	36 x 36		42 x 42 – 4242		\$1314	1643
	rectangle		48 x 48 – 4848		\$1330	1664
42 DIA	42 x 42		30 x 60 – 3060		\$1288	1608
48 DIA	48 x 48					
			<b>laminite top</b>			
			36 dia – 36D		\$1061	1325
			42 dia – 42D		\$1112	1389
			48 dia – 48D		\$1126	1406
			36 x 36 – 3636		\$1065	1333
			42 x 42 – 4242		\$1117	1395
			48 x 48 – 4848		\$1131	1414
			30 x 60 – 3060		\$1093	1366



to specify: please refer to pages 3-4 for complete specifying information. Specify all products by their product code.

pricing effective: August 3, 2022 4:04 PM

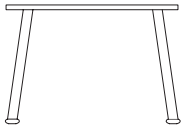

25 inch height



zoon table		model	top size/code	list price/edge codes	V2	W2
<b>steel base</b>		ZNT-25H	<b>wood top</b>			
H25			36 dia – 36D		\$1280	1599
			42 dia – 42D		\$1339	1675
round	square		48 dia – 48D		\$1358	1698
			36 x 36 – 3636		\$1285	1608
36 DIA	36 x 36		42 x 42 – 4242		\$1348	1682
42 DIA	42 x 42		48 x 48 – 4848		\$1363	1705
48 DIA	48 x 48		30 x 60 – 3060		\$1318	1648
			<b>laminata top</b>			
			36 dia – 36D		\$1087	1359
		42 dia – 42D		\$1138	1425	
		48 dia – 48D		\$1153	1441	
		36 x 36 – 3636		\$1093	1366	
		42 x 42 – 4242		\$1144	1430	
		48 x 48 – 4848		\$1159	1447	
		30 x 60 – 3060		\$1120	1401	

to specify: please refer to pages 3-4 for complete specifying information. Specify all products by their product code.

pricing effective: August 3, 2022 4:04 PM