LELAND

Price List

GSA

Contract #47QSMA22D08PJ

Contract #47QSMA22D08PK



Pricing Effective: May 2023

GSA Contract Information

LELAND

Contract:	MAS Multiple Award Schedule, Large Category: Furniture & Furnishings
Contract Numbers:	47QSMA22D08PJ and 47QSMA22D08PK
Contract Period:	March 31, 2022 – March 30, 2027
Contractor's Information:	Leland Furniture 5695 Eagle Drive SE Grand Rapids, MI 49512 616.975.9260 (p) 616-975-9280 (f)
Contract Administrator:	Stephanie Chandonnet Phone: 616.975.9260 ext 101 Email: schandonnet@lelandfurniture.com
PO Submission:	Email: hello@lelandfurniture.com Fax: 616.975.9280
Installation Charges:	Not Awarded on Leland GSA Contract. Dealer must provide installation cost to both the End User and Leland. Leland will invoice for this amount and the dealer will be reimbursed within 30 days of final payment from the End User. Leland is not responsible for installation costs incurred above what was quoted by the dealer.
RFQ's/GSA Ebuy:	Leland provides weekly review of Federal Government RFQ's advertised through GSA's Ebuy System as well as other. As requirements vary Leland will request your support in RFQ preparation expressed as either quotations for services or as the need for strategic Teaming Agreements are apparent.
Order Procedures:	End User Orders All GSA Schedule Orders must be issued by the customer to "Leland International" and are treated as End User Direct orders to be entered and invoiced by Leland International. The dealer may submit GSA PO along with the Dealers Fax Cover Sheet that can provide additional

Leland International
5695 Eagle Drive, SE
Grand Rapids, Michigan 49512
616-975-9260 | 616.975.9280 Fax
lelandfurniture.com

Authorized Commercial 3rd Parties

Leland will accept orders from Commercial 3rd Parties such as other Manufacturers/Dealers, Builders/Developers, General Contractors, Project Management Companies, Installers, etc., that have obtained authorization from eligible GSA Schedule End Users.

Leland will provide a Standard GSA Schedule Authorization form if one is needed. Leland will not accept commercial 3rd Party orders that do not have documented Authorization to utilize GSA Schedule Pricing.

Teaming Agreements:

Leland will execute Teaming Agreements based on Customer Request with interested commercial 3rd Parties. Interested parties must provide the Project Name and Location of the project as well as the GSA Contract number and contract expiration date of any proposed Team Leader for that project.

Leland has a Standard Teaming Agreement Letter Template that should be provided to interested commercial teaming partners. Contact Stephanie Chandonnet with your requests.

Referenced Price Lists:

Contact Leland Customer Experience for pricing

GSA Discount:

Standard GSA Discount - 52.78% off list (incl of IFF)

GSA Quantity Discount:

3% Additional for Seating orders exceeding 350 Units

Point of Production:

Grand Rapids, MI 49512

Freight:

FOB Destination, Prepay and Add

Delivery Terms:

30–45 Days ARO

Expedited Delivery:

No GSA Program - Contact Leland International for rush projects

Minimum Order:

\$100.00

UEI:

QG5BJPZJL2N3

Leland International

5695 Eagle Drive, SE
Grand Rapids, Michigan 49512
616-975-9260 | 616.975.9280 Fax
lelandfurniture.com

Credit Cards Accepted: Yes, below and above Micro Purchase threshold

Prompt Payment Terms: 1% Net 20 Days

CCR Registration: Active, Cage Code 5HQW8

Awarded SIN Groups: Contract 47QSMA22D08PJ:
SIN 33721
SIN 33712
SIN 33721T

Contract 47QSMA22D08PK:
SIN 337127CFBS
SIN 337127LFSB

Warranty: Leland Standard 5 Year Warranty

GSA Price List

Terms & Conditions: Table of Contents	2
Ordering Information	4
Terms, Conditions & General Information	6
Freight Program	9

Amadeus Pricelist, SIN 33721	AM
Brit Bench Pricelist, SIN 33721	BBM
Cambre Table Pricelist, SIN 33721	CA
Café Parfait Pricelist, SIN 337127CFSB	CP
Ease Pricelist, SIN 33721T	ES
Ebb Fully Upholstered Bench Pricelist, SIN 33721	EB
Fast Table Pricelist, SIN 33721	FT
Fixed Table Pricelist, SIN 33721	FXT
Fly Table Pricelist, SIN 33721	FLY
Hammok Pricelist, SIN 33721	HS
Handy Stool Pricelist, SIN 33721	HA
Leah Table Pricelist, SIN 33721	LT
M2 Seating Pricelist, SIN 33721T	M2S
M3 Table Pricelist, SIN 337127CFSB	M3T
Marquette Pricelist, SIN 33721T and SIN337127CFSB (Bar and Counter Models)	MQ
Mass Chair Pricelist, SIN 33721	MA
Omena Pricelist, SIN 33721	OM
Parfait II Pricelist, SIN 337127CFSB	PII

Pluto Bench Pricelist, SIN 33721	PB
Quarry Pricelist, SIN 33721	QR
Rapson Forty-Eight Chair Pricelist, SIN 33721	RP48-C
Rapson Thirty-Nine Bench Pricelist, SIN 33721	RP39-B
Rapson Thirty-Nine Guest Pricelist, SIN 33721	RP39-G
Rapson Thirty-Nine Lounge Pricelist, SIN 33721	RP39-L
Slam Pricelist, SIN 33721	SL
Slam Beam Pricelist, SIN 33721	SB
Valeri Pricelist, SIN 33721	VS

Orders

All orders must be submitted in writing either by fax or e-mail. Specify each item by its product code and the corresponding model description, finish, upholstery and options offered in the price list. If the customer's current product order must match a previous order, Leland International must be notified. A sample product from the original order must be submitted at the expense of the customer to assure uniformity of finish and construction. Orders with missing or incorrect information such as model, finish, color, pricing, etc. will be scheduled upon receipt of correct and complete information.

Leland products are specified for and installed in a variety of end user applications. It is the responsibility of the purchasing party to understand the end user's intent and purchase products appropriate for that application. Leland takes no responsibility for incorrect specifications. Acceptance and fulfillment of any purchase order does not imply that the product is suitable for a certain application. Leland will only warranty products that have been installed in applications for which they were designed.

If multiple delivery schedules are required, the customer must submit separate purchase orders for each delivery date.

Acknowledgement

Orders are only accepted by issuance of our formal acknowledgment. It is the purchaser's responsibility to check acknowledgements and invoices for accuracy. If there is any discrepancy, the customer must notify Leland International within 72 hours. Failure to notify Leland International within this time period will constitute acceptance of the order as acknowledged, and our acknowledgment is final and binding.

All acknowledgments will contain an estimated ship date. If for some reason the furniture must not ship earlier than the estimated ship date, please specify a "Do not ship before date" in your purchase order. We are not responsible for delays in scheduling or failure to make scheduled ship date due to strikes, lockouts or other labor complications, war, riots, Acts of God, fires, accidents, restraints affecting shipment or credit, reduced supply or excessive cost of fuel or raw material, delays from suppliers, compliance with government regulations or other unforeseen contingencies.

Wood Finishes

Wood finishes can be light sensitive; therefore, care should

be taken to avoid placing chairs in areas exposed to intense natural light. Due to variations common to all wood species,

the color and grain characteristics of the finish samples may not exactly match that of the finished product. Custom finishes must meet factory approval and are subject to a \$100.00 minimum net mixing charge. Please allow up to three weeks to prepare the custom wood finish match sample. Orders will not be scheduled or acknowledged until finish match approval is received in writing.

Due to limitations of the raw materials and the natural background color of wood, not all colors can be successfully reproduced. The suitability of a color for custom finish matching cannot always be determined beforehand. This is especially true in the case of custom colors submitted on non-wood products. If we are unable to produce a commercial match to your custom color, you will be notified at the earliest possible date, and no charge will be levied.

Laminates

The following laminates with the manufacturers noted are considered to be standard and are usually in stock.

FORMICA®

www.formica.com/en/us/trade-products or call 800.367.6422

Select solid colors, wood grains or patterns
 Select number/name
 Select standard finishes
 Laminates with -58 (matte finish) are standard

WILSONART®

www.wilsonartcontract.com/pattern-availability/
 or call 800.433.3222

Select laminate finish,
 Select Leland standard finish -38 (fine velvet texture)
 or -60 (matte)

PIONITE®

www.pionite.com/pionite/pages_pionite/pionite_colors.html
 or call 800.746.6483

Select colors

Customer's Own Information (COM)

Leland International reserves the right of preliminary approval of all COM, prior to order acceptance. Even after such preliminary approval, Leland International reserves the right to reject COM if, upon physical inspection of the COM, it proves unacceptable for use on Leland International products. When this occurs, the customer will be notified in writing with an explanation of the problem. A written release from the customer will be required for the order to be processed.

It is recommended that all COM textile be tested for compatibility with Leland's products prior to sending COM to Leland for application. Please contact Customer Experience to request the COM Approval Form with instructions for COM submittal.

Choosing not to have COM textile tested for compatibility may result in the COM being rejected at the expense of the customer.

Leland International cannot assume responsibility for durability, appearance or other qualities of customer's own material on the finished product and does not give any warranty with respect to COM. At Leland International's discretion,

additional yardage, labor charges, or handling surcharges may be required as a condition of COM acceptance. COM delivered to Leland International without proper identification may be refused, and Leland International shall have no responsibility for loss or any other claims. Excess textile will not be returned unless specifically requested in writing.

Please contact the Leland Customer Experience Department for yardage requirements on all COM textiles which are patterned or narrower than 54 inches wide.

Orders using COM may be rescheduled if the COM has not been received two (2) weeks prior to the original ship date. Every effort will be made to avoid a delay and to complete the customer's order within the standard lead time.

All shipments of COM to Leland International must be sent prepaid. COM should be sent to:

LELAND INTERNATIONAL
5695 Eagle Drive SE
Grand Rapids, Michigan 49512

COM packages must include the following information:

- Name of customer

- Purchase order number to which the material is to be applied and Leland Sales Order, if known.

Purchase orders specifying COM must include the following:

- Indicate which side of the textile is to be exposed (manufacturer's implied face will be used if no side is indicated by the customer).
- If textile is a stripe or pattern, specify vertical or horizontal upholstered application (textile will be applied off the bolt if no direction is indicated by the customer).
- COM suppliers' name, textile number and quantities of pieces to which the material is to be applied.

California Technical Bulletin 133 [TB 133]

TB 133 is a full scale fire performance test of complete articles of seating furniture. Some Leland International products in combination with a variety of upholstery textiles have been tested and are in compliance with TB 133. Test documentation is available upon request. If you wish to specify Leland products that have not been tested for compliance with TB 133 please consult Leland Customer Experience Department for TB 133 testing cost information.

In order for Leland products to comply with TB 133 the foam must be protected with a fire blocker or a special fire retardant foam must be used. For those products that must comply with TB 133 there will be a net charge per chair for fire blocker laminating or fire retardant foam. Please contact Leland International for a CAL 133 quotation on all seating.

Since TB 133 tests furniture and not components, there are no TB 133 approved textiles. Textiles comprised solely or in any combination of the following fibers are more likely to be suitable components for chairs that must comply with TB 133.

- | | | |
|----------------|--------------|-----------|
| Acrylic | Nylon | |
| Vinyl | Animal Hairs | Polyester |
| Wool | | Virgin |
| Cordura | Rayon | |
| Viscose | Cotton | |
| SEF Modacrylic | Wool | |
| Leather | Silk | |
| Worsted Wool | Modacrylic | |
| Spun Nylon | Mohair | |
| Trevira | | |

Prices

All prices are list prices F.O.B. our factory in Grand Rapids, Michigan 49512. Our pricing includes packing and corrugated cartoning for common carrier shipments. List prices do not include freight, storage, taxes or additional packaging required for certain carriers and are subject to change without notice.

We reserve the right to change quotation prices prior to acceptance by the buyer. Quotation prices must be accepted within 30 days unless otherwise specified in writing on the quotation. Pricing on orders specifying shipment 90 days or more after the formal date of acknowledgment will be based on pricing prevailing at time of shipment.

Resale Rights

Leland International reserves the right to reject any order placed by any customer for any reason, irrespective of whether orders have been previously accepted from such customer, without incurring liability to such customer. No customer shall have a continuing right to buy products from the company except pursuant to a formal dealer agreement or other written agreement covering future supply executed by the company and the reseller. Distribution of the price list or catalog does not itself constitute an offer to sell.

Credit and Payment Terms

An open account may be established for new customers. One bank and three trade references will be required and must be faxed to Leland International, attention:

Accounting. Credit will be established upon review and approval of your application.

Allow up to four weeks delay for credit approval. To avoid this delay, orders on new accounts must be accompanied by a 50% deposit. If credit is approved by the time the order is ready for shipment, the balance must be paid within terms. Accounts that are inactive for a twelve month period will automatically be closed and are subject to the above conditions for new accounts. Leland International may change or cancel credit at its discretion and may request advance payment at any time.

Upon establishment of an open account, terms are "Net 15 Days" after date of invoice with a credit limit established on a per customer basis. 1½% per month service charge will be added to all past due accounts. Orders will not be processed for past due accounts until the amount due, including any

service charge, is paid in full. All custom orders will require a down payment of 50% and will not be scheduled for production until the down payment is received.

Leland International reserves the right to revoke the terms of any customer at any time for any reason.

Orders for customers that have pre-paid terms require payment in full in (7) seven business days prior to the scheduled ship date. Payment not received by this day may result in the order being rescheduled.

Changes and Cancellations

Orders are not subject to change or cancellation without factory approval. Leland International will make every reasonable effort to stop production scheduling, shipment, etc., upon receipt of written notification of changes, cancellations or deferments stipulated as follows. Approved cancellations, changes, and delivery date extensions may be subject to charges.

Cancellations

Cancellations received prior to production will be assessed a \$100 net cancellation charge. Cancellations received after production has been started will be assessed the total accumulated cost of the project plus a \$100 net cancellation charge.

Deferred Shipments

If the order is complete or in the production cycle, charges will be assessed from the completion date in accordance with policy for "Storage by the Manufacturer."

Storage by the Manufacturer

If the customer cannot accept delivery when merchandise is ready, according to the terms of our acknowledgment, we reserve the right to transfer goods to storage at the customer's expense, and the order will be invoiced at the time of storage. Payment of this invoice will be due on the original terms given to the customer. Storage charges and freight charges for delivery will be invoiced separately upon release of the merchandise from storage and will be due upon receipt of the invoice. Orders put into storage require payment in full and all incurred storage charges must be paid prior to the order being shipped.

Shipping

We will ship in accordance with the customer's written instructions. If customer omits specific shipping instructions, we will ship in the manner that we consider to be the best way. All shipments are sent F.O.B. Grand Rapids, Michigan 49512. Leland International's liability ends when received by the carrier at Leland International's dock. Title of the goods and risk of loss transfers to the buyer at that time. Freight shall be paid by the buyer unless otherwise acknowledged in writing by Leland International. We make every effort to ship orders complete and on schedule. We reserve the right to make partial shipments as merchandise is ready. Failure to deliver all the merchandise at one time does not relieve the customer of the obligation to accept and pay for merchandise received.

Damage Claims

All Leland International products are thoroughly inspected prior to shipment from our factory and packed to comply with carrier requirements. Customers must carefully inspect all items upon arrival and note any damage on the delivery receipt. Phrasing such as "Subject to Inspection" does not constitute a note of damage and will not be accepted as grounds for honoring a freight claim. A written claim must be filed within 15 days of receipt with the carrier if any obvious or subsequent

concealed damage is discovered and still does not guarantee the honoring of freight claim. Caution: When a clear receipt is obtained by a carrier, Leland International, nor the carrier, are any longer responsible for damages or shortages. Processing claims for damage and shortages are the responsibility of the buyer unless otherwise specified in writing by Leland International. At no time can claims be deducted from our invoices.

Delivery Charges

Charges incurred by Leland International complying with any non-standard shipment request such as inside delivery, expediting, redelivery, weekend delivery, unpacking, straight trucks, specific driver requests, or temporary holding will be invoiced to the purchaser.

Storage by Owner

Due to the inherent nature of wood products, we cannot guarantee any product stored or set in place in an environment where temperature and humidity are not controlled. Temperatures must be maintained within a range of 50°-80° F (10°-27° C); the relative humidity must be maintained between 25% and 40%. These conditions are also recommended for human health standards.

Product Discrepancy

Errors in products including color, size, other variations, or missing components must be reported to Leland International within thirty (30) days of delivery. Failure by the purchaser to report any product inaccuracies within thirty (30) days of delivery shall constitute acceptance of the product.

Miscellaneous

All costs for furniture installation, removal from service and reinstallation due to damage claims, partial shipments, shipping errors or warranty claims is the responsibility of the customer. Leland International will not be liable for costs associated with any of the above conditions.

Sizes and weights are considered to be approximate. Leland International reserves the right to make changes in design and construction or discontinue products without notice. Due to conditions beyond our control all wood products, textiles and vinyls are subject to variations in color, texture and grain.

Price list specifications supersede all other specifications whether verbal or written, and may not be altered without the written consent of an officer of Leland International. All clerical errors on any agreement, publication, correspondence, price list, or product literature pieces are subject to correction at any time.

MAINTENANCE

Since chairs and tables are installed and used under a variety of conditions, users must make inspections no less than every six months to look for damage or signs of structural fatigue incurred in daily handling, use and abuse. Examinations must include welds, machine screw assemblies and the shell to base fasteners. If problems are discovered that could compromise the structural safety of a chair, it should be immediately removed from service and Leland International should be notified. Coats and other articles should not be hung on the back of chairs. This practice may cause chairs to be unstable. Chairs are not designed to be placed seat down on table surfaces. Chairs stored in this manner are unstable. The shock of chairs falling from table tops may compromise the structural integrity of the shell/base attachment.

Warranty

All merchandise is manufactured in accordance with our high industrial and design standards and is warranted to be free from defects of material and workmanship for a period of (5) five years from the date of delivery or placement in storage. This warranty covers goods under normal use and is in service under conditions for which the merchandise is designed. Leland International considers normal use to be (5) five days per week (8) eight hours per day. Extended use (multiple shifts, 24 hour facilities, etc) will reduce this warranty to (2) two years. We offer no warranty on chair upholstery materials, plastic laminate table surfaces and operating components other than those expressed by the manufacturer of those components.

Our obligation during this warranty period is limited to repair or replacement at our option. This warranty becomes null and void on any goods repaired or altered by any person not so authorized by Leland International or any merchandise which has been subject to misuse, improper storage, including placing chairs seat down on tables, negligence, or accident. We make no other warranties either expressed or implied as to any matter whatsoever, including without limitation, the condition of the merchandise, its merchantability, or its fitness for any particular user or purpose.

All claims will be processed by the Customer Experience Department. All returns must be authorized in writing. Merchandise authorized for return and subsequent repair or replacement merchandise shall be removed from service. All shipping, packaging, and installation charges shall be at the expense of the customer. Since furniture is installed and used under a variety of conditions, users are required to make inspections every six months to look for damage or

signs of structural fatigue incurred in daily handling, use, or abuse. Inspections must include, but are not limited to, the tightening of bolts and fasteners, and the lubrication of mechanisms. Failure to properly maintain Leland products will void this warranty.

Leland International will not be liable for loss of time, inconvenience, commercial loss, or incidental or consequential damages that may result from a warranty claim.

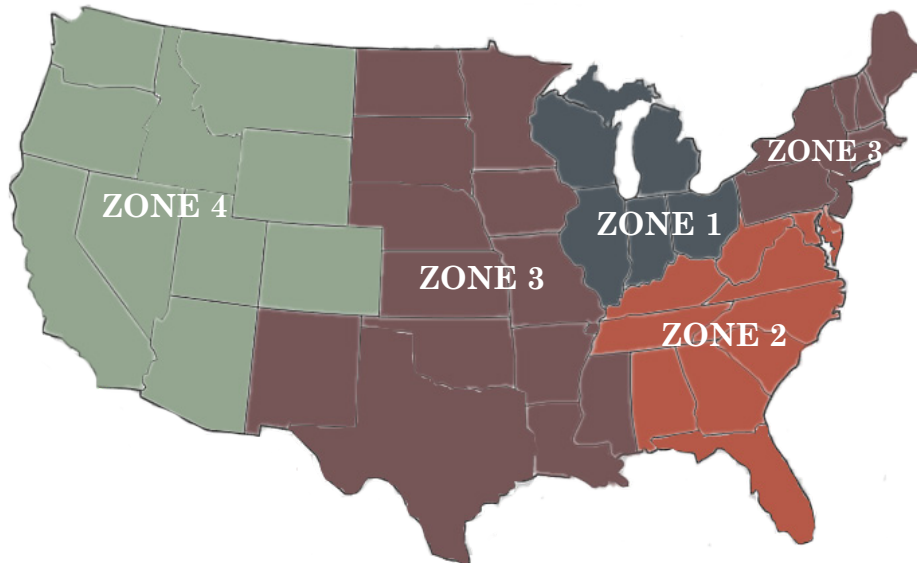

Zone 1 (4%)	Zone 2 (5%)	Zone 3 (6%)	Zone 3 (6%) CONT.	Zone 4 (7%)
Indiana	Alabama	Arkansas	New Hampshire	Arizona
Illinois	Delaware	Connecticut	New Jersey	California
Michigan	Florida	Iowa	New Mexico	Colorado
Ohio	Georgia	Kansas	New York	Idaho
Wisconsin	Kentucky	Louisiana	North Dakota	Montana
	Maryland	Maine	Oklahoma	Nevada
	North Carolina	Massachusetts	Pennsylvania	Oregon
	South Carolina	Minnesota	Rhode Island	Utah
	Tennessee	Mississippi	South Dakota	Washington
	Virginia	Missouri	Texas	Wyoming
	Washington DC	Nebraska	Vermont	
	West Virginia			

Overview

Leland Furniture's Freight Program is offered to all customers for convenient and competitive freight prices in the continental United States.

How It Works

1. Determine the LIST value of your order.
2. Determine the zone to which the freight will be shipping (Zones 1-4)
3. Calculate your freight charges by multiplying the list price and applicable zone charges (e.g.: \$10,000 LIST order shipping to Arizona is \$10,000 x 0.07 = \$700 NET freight).
4. Verify that your calculated charges meet or exceed minimums.
5. Note on your PO "Freight determined by Leland Freight Program".

Zone Percentages and Minimums

Zone 1	4%	Minimum \$350
Zone 2	5%	Minimum \$350
Zone 3	6%	Minimum \$350
Zone 4	7%	Minimum \$350

Remember

Freight percentages are based on LIST price of order.

Leland Furniture Freight Program is based on dockside delivery only. Residential Delivery, Inside Delivery, etc. will incur additional charges; please contact Leland Customer Service for current prices.

Freight is FOB Grand Rapids, MI 49512; the receiving company is responsible for noting any damage at the time of delivery on the Delivery Receipt. Leland Furniture assumes no responsibility for freight damage, either noted on delivery receipt or concealed.

As fuel prices fluctuate, Leland Furniture reserves the right to add necessary fuel surcharges.

Leland Furniture reserves the right to change or discontinue the Freight Program at any time.

Amadeus

July 2021 Price List



Amadeus

Table of Contents	AM2
Specification Information	AM3
Specification Example	AM4
Stacking/ganging sled base	AM5
Stacking Chair Tapered Four Leg Base	AM7
Arm Chair, Tapered Four Leg Base	AM9
Side Chair, Wood Base	AM11
Counter Chair, Sled base	AM13
Counter Chair, Wood Base	AM15
Bar Chair, Sled base	AM17
Bar Chair, Wood Base	AM19

Chair Model

DESCRIPTION	CODE
AMADEUS stacking/ganging sled base	AMS
AMADEUS stacking chair, tapered four leg base	AM4
AMADEUS stacking arm chair, tapered four leg base	AMA
AMADEUS side chair, wood base	AMSW
AMADEUS counter chair	AMCS
AMADEUS counter chair, wood base	AMCW
AMADEUS bar chair	AMBS
AMADEUS bar chair, wood base	AMBW

Shell Selection

DESCRIPTION	CODE
Polypropylene	PO
Polypropylene with Upholstered Seat Only	PU
Fully Upholstered	FU
3D Beech Veneer	3DB
3D Beech Veneer with Upholstered Seat Only	3BU
3D American Walnut Veneer	3DW
3D American Walnut Veneer with Upholstered Seat Only	3WU

Shell Finish/Color

POLYPROPYLENE SHELL:

DESCRIPTION	CODE	DESCRIPTION	CODE
White	WT	Arctic	AR
Black	BK	Caribbean	CB
Soda Red	SR	Ink	IN
Dolphin	DL	Limelight	LL
Oxford	OX	Tangerine	TN
Ice Blue	IB		

CUSTOM POLYPROPYLENE COLORS

Custom color match is available upon request.
Please contact hello@lelandfurniture.com for further information

BEECH 3D VENEER SHELL:

DESCRIPTION	CODE
Natural Beech	09

STANDARD LELAND COLORS

AMERICAN WALNUT 3D VENEER SHELL:

DESCRIPTION	CODE
Natural Walnut Matte	08M

Fully Upholstered or Only Selection

Please refer to Leland Textile Program which features textiles and leathers from the following partners:

- Camira
- Green Hides
- Carnegie
- Maharam
- CF Stinson
- Unika Vaev

The complete grade list can be found on our website or you can specify COM/COL. Due to the design of this product, it is recommended that all non pre-approved textile be tested for compatibility.

Frame Finishes

SLED BASE & TAPERED FOUR LEG BASE:

DESCRIPTION	CODE
Sterling	ST
Warm Grey	WG
Cool Grey	CG
Black	B
White	W
Matte Gold Rush	MGR
Matte Mercury	MMR
Matte Mineral	MMN
Matte Burnish	MBN
Matte Foundry	MFN
Matte New Penny	MNP
Chrome	C

TEXTURED	CODE
White Textured Powder coat	WT
Black Textured Powder coat	BT
Grey Textured Powder coat	GT
Soda Red Textured	SRT
Dolphin Textured	DLT
Oxford Textured	OXT
Tangerine Textured	TNT
Ice Blue Textured	IBT
Artic Textured	ART
Caribbean Textured	CBT
Limelight Textured	LLT
Ink Textured	INT

Glide or Caster Type

STANDARD GLIDES:

DESCRIPTION	CODE
Poly (Sled base)	S
Nylon (Tapered Four leg Base) & Wood Base	S

OPTIONAL GLIDES:

DESCRIPTION	CODE
Felt	FC

*Please note that optional glides for four leg models raise the chair height .5 inch.

Stacking note

Amadeus side chair, armless models stack as follows: (including upholstered)

SLED BASE:

ARMLESS:
Floor: 15 High
Dolly: 20 High

TAPERED FOUR LEG BASE:

ARMLESS:
Floor: 10 High
Dolly: 12 High

Specifications required to create the product code

- Model
- Shell Selection
- Shell Finish/Color
- Upholstered Onlay Selection (when applicable)
- Frame Finish (or foot ring where applicable)
- Glide Type

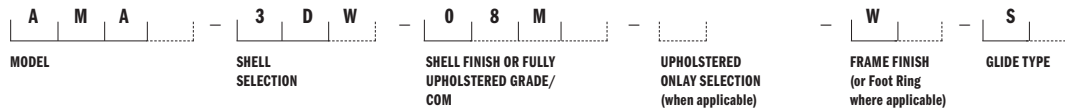

MODEL

Amadeus arm chair, Tapered four leg base (AMA)

SHELL SELECTION

3D American Walnut Veneer (3DW)

SHELL FINISH/COLOR

Natural Walnut Matte (08M)

UPHOLSTERED ONLAY SELECTION

When applicable, enter upholstery grade, COM

FRAME FINISH (OR FOOT RING WHERE APPLICABLE)

White (W)

GLIDE TYPE

Standard Nylon (S)



AMADEUS STACKING/GANGING SLED BASE
Design: Martin Ballendat

AM5



Amadeus Sled Base Chair	MODEL	FRAME FINISH	LIST PRICE
Polypropylene shell	AMS-PO	Powder Coat	\$357
W 21 D 21.75 H 31.75 SH 18		Chrome	\$413

Optional Glides: Add \$8.00 net per chair for a set of four (4).



Amadeus Sled Base Chair	MODEL	LIST PRICE/GRADE	COM/COL	A	B	C	D	E	F	G	H	I	J	K	L
Polypropylene shell upholstered seat onlay	AMS-PU	Powder Coat	\$480	519	538	557	577	596	616	635	655	674	694	713	733
		Chrome	\$535	574	593	613	632	652	671	690	710	729	749	768	788

W 21 D 21.75 H 32 SH 19

COM Yardage: 1 or 2 seats: .75 yard
Contact Leland Customer Experience for yardage requirements on textiles with repeats.
Optional Glides: Add \$8.00 net per chair for a set of four (4).



Amadeus Sled Base Chair	MODEL	LIST PRICE/GRADE	COM/COL	A	B	C	D	E	F	G	H	I	J	K	L
Fully upholstered	AMS-FU	Powder Coat	\$601	681	722	763	804	845	886	927	968	1009	1050	1091	1132
		Chrome	\$658	740	780	821	862	903	944	985	1026	1067	1108	1149	1190

W 21 D 21.75 H 32 SH 18

COM Yardage: 1 seat: 1.5 yards
Contact Leland Customer Experience for yardage requirements on textiles with repeats.
Optional Glides: Add \$8.00 net per chair for a set of four (4).

To specify:
Please refer to pages 3-4 for complete specifying information.
Specify all products by their product code.

Pricing Effective: July 2021

AMADEUS STACKING/GANGING SLED BASE
Design: Martin Ballendat

AM6



Amadeus Sled Base Chair	MODEL	FRAME FINISH	LIST PRICE
3D Beech veneer shell	AMS-3DB	Powder Coat	\$640
W 21 D 21.75 H 31.75 SH 18		Chrome	\$696

Optional Glides: Add \$8.00 net per chair for a set of four (4).



Amadeus Sled Base Chair	MODEL	LIST PRICE/GRADE	COM/COL	A	B	C	D	E	F	G	H	I	J	K	L
3D Beech veneer shell, upholstered seat onlay	AMS-3BU	Powder Coat	\$762	801	820	840	859	879	898	918	937	957	976	995	1015
		Chrome	\$818	857	877	896	915	935	954	974	993	1013	1032	1052	1071

W 21 D 21.75 H 32 SH 19

COM Yardage: 1 or 2 seats: .75 yard
Contact Leland Customer Experience for yardage requirements on textiles with repeats.
Optional Glides: Add \$8.00 net per chair for a set of four (4).



Amadeus Sled Base Chair	MODEL	FRAME FINISH	LIST PRICE
3D Walnut veneer shell	AMS-3DW	Powder Coat	\$925
W 21 D 21.75 H 31.75 SH 18		Chrome	\$980

Optional Glides: Add \$8.00 net per chair for a set of four (4).



Amadeus Sled Base Chair	MODEL	LIST PRICE/ GRADE	COM/COL	A	B	C	D	E	F	G	H	I	J	K	L
3D Walnut veneer shell, upholstered seat onlay	AMS-3WU	Powder Coat	\$1047	1086	1106	1125	1145	1164	1184	1203	1223	1242	1262	1281	1300
		Chrome	\$1103	1141	1161	1180	1200	1219	1239	1258	1278	1297	1317	1336	1356

W 21 D 21.75 H 32 SH 19

COM Yardage: 1 or 2 seats: .75 yard
Contact Leland Customer Experience for yardage requirements on textiles with repeats.
Optional Glides: Add \$8.00 net per chair for a set of four (4).

To specify:
Please refer to pages 3-4 for complete specifying information.
Specify all products by their product code.

Pricing Effective: July 2021



**Amadeus
Tapered Four Leg Base Chair**

	MODEL	FRAME FINISH	LIST PRICE
Polypropylene shell	AM4-PO	Powder Coat	\$411
W 21 D 22 H 32 SH 18		Chrome	\$468

Optional Glides: Add \$8.00 net per chair for a set of four (4).



**Amadeus
Tapered Four Leg Base Chair**

	MODEL	LIST PRICE/GRADE	COM/COL	A	B	C	D	E	F	G	H	I	J	K	L
Polypropylene shell, upholstered seat onlay	AM4-PU	Powder Coat	\$534	573	592	631	650	670	689	709	728	748	976	767	787
		Chrome	\$590	629	648	668	687	707	726	746	765	785	804	824	843

W 21.5 D 22 H 32 SH 19

COM Yardage: 1 or 2 seats: .75 yard
Contact Leland Customer Experience for yardage requirements on textiles with repeats.
Optional Glides: Add \$8.00 net per chair for a set of four (4).



**Amadeus
Tapered Four Leg Base Chair**

	MODEL	LIST PRICE/GRADE	COM/COL	A	B	C	D	E	F	G	H	I	J	K	L
Fully upholstered	AM4-FU	Powder Coat	\$657	738	779	820	861	902	943	984	1025	1066	1107	1148	1189
		Chrome	\$716	798	839	880	921	961	1002	1043	1084	1125	1166	1206	1247

W 21.5 D 22 H 32 SH 18

COM Yardage: 1 seat: 1.5 yards
Contact Leland Customer Experience for yardage requirements on textiles with repeats.
Optional Glides: Add \$8.00 net per chair for a set of four (4).

To specify:
Please refer to pages 3-4 for complete specifying information.
Specify all products by their product code.



**Amadeus
Tapered Four Leg Base Chair**

	MODEL	FRAME FINISH	LIST PRICE
3D Beech veneer shell	AM4-3DB	Powder Coat	\$695
W 21.5 D 22 H 32 SH 18		Chrome	\$750

Optional Glides: Add \$8.00 net per chair for a set of four (4).



**Amadeus
Tapered Four Leg Base Chair**

	MODEL	LIST PRICE/GRADE	COM/COL	A	B	C	D	E	F	G	H	I	J	K	L
3D Beech veneer shell, upholstered seat onlay	AM4-3BU	Powder Coat	\$817	856	875	895	914	934	953	973	992	1012	1031	1051	1070
		Chrome	\$872	911	931	950	970	989	1008	1028	1047	1067	1086	1106	1125

W 21.5 D 22 H 32 SH 19

COM Yardage: 1 or 2 seats: .75 yard
Contact Leland Customer Experience for yardage requirements on textiles with repeats.
Optional Glides: Add \$8.00 net per chair for a set of four (4).



**Amadeus
Tapered Four Leg Base Chair**

	MODEL	FRAME FINISH	LIST PRICE
3D Walnut veneer shell	AM4-3DW	Powder Coat	\$980
W 21.5 D 22 H 32 SH 18		Chrome	\$1037

Optional Glides: Add \$8.00 net per chair for a set of four (4).



**Amadeus
Tapered Four Leg Base Chair**

	MODEL	LIST PRICE/ GRADE	COM/COL	A	B	C	D	E	F	G	H	I	J	K	L
3D Walnut veneer shell upholstered seat onlay	AM4-3WU	Powder Coat	\$1103	1141	1161	1180	1200	1219	1239	1258	1278	1297	1317	1336	1356
		Chrome	\$1159	1198	1217	1237	1256	1276	1295	1315	1334	1353	1373	1392	1412

W 21.5 D 22 H 32 SH 19

COM Yardage: 1 or 2 seats: .75 yard
Contact Leland Customer Experience for yardage requirements on textiles with repeats.
Optional Glides: Add \$8.00 net per chair for a set of four (4).

**To specify:
Please refer to pages 3-4 for
complete specifying information.
Specify all products by their
product code.**

AMADEUS ARM CHAIR, TAPERED FOUR LEG BASE
Design: Martin Ballendat

AM9



**Amadeus Arm Chair
Tapered Four Leg Base Chair**

	MODEL	FRAME FINISH	LIST PRICE
Polypropylene shell	AMA-PO	Powder Coat	\$446
W 23.5 D 21.75 H 32 SH 18 AH 26		Chrome	\$529

Optional Glides: Add \$8.00 net per chair for a set of four (4).



**Amadeus Arm Chair
Tapered Four Leg Base Chair**

	MODEL	LIST PRICE/GRADE	COM/COL	A	B	C	D	E	F	G	H	I	J	K	L
Polypropylene shell, upholstered seat onlay	AMA-PU	Powder Coat	\$568	607	627	646	666	685	705	724	743	763	782	802	821
		Chrome	\$636	675	695	714	734	753	773	792	812	831	851	870	889

W 23.75 D 22 H 32
SH 19 AH 26

COM Yardage: 1 or 2 seats: .75 yard
Contact Leland Customer Experience for yardage requirements on textiles with repeats.
Optional Glides: Add \$8.00 net per chair for a set of four (4).



**Amadeus
Tapered Four Leg Base Chair**

	MODEL	LIST PRICE/GRADE	COM/COL	A	B	C	D	E	F	G	H	I	J	K	L
Fully upholstered	AMA-FU	Powder Coat	\$693	775	816	857	898	939	980	1021	1062	1103	1142	1183	1224
		Chrome	\$764	846	887	928	969	1010	1051	1092	1133	1174	1215	1256	1296

W 23.5 D 21.75 H 32
SH 18 H 26

COM Yardage: 1 seat: 1.5 yards
Contact Leland Customer Experience for yardage requirements on textiles with repeats.
Optional Glides: Add \$8.00 net per chair for a set of four (4).

To specify:
Please refer to pages 3-4 for complete specifying information.
Specify all products by their product code.

Pricing Effective: July 2021

AMADEUS ARM CHAIR, TAPERED FOUR LEG BASE
Design: Martin Ballendat

AM10



**Amadeus Arm Chair
Tapered Four Leg Base**

	MODEL	FRAME FINISH	LIST PRICE
3D Beech veneer shell	AMA-3DB	Powder Coat	\$991
W 23.75 D 22 H 32 SH 19 AH 26		Chrome	\$1101

Optional Glides: Add \$8.00 net per chair for a set of four (4).



**Amadeus Arm Chair
Tapered Four Leg Base Chair**

	MODEL	LIST PRICE/ GRADE	COM/COL	A	B	C	D	E	F	G	H	I	J	K	L
3D Beech veneer shell, upholstered seat onlay	AMA-3BU	Powder Coat	\$1150	1202	1226	1253	1278	1303	1329	1354	1379	1404	1431	1455	1481
		Chrome	\$1227	1279	1305	1330	1356	1381	1408	1432	1457	1483	1508	1534	1558

W 23.75 D 22 H 32
SH 19 AH 26

COM Yardage: 1 or 2 seats: .75 yard
Contact Leland Customer Experience for yardage requirements on textiles with repeats.
Optional Glides: Add \$8.00 net per chair for a set of four (4).



**Amadeus Arm Chair
Tapered Four Leg Base**

	MODEL	FRAME FINISH	LIST PRICE
3D Walnut veneer shell	AMA-3DW	Powder Coat	\$1401
W 23.5 D 21.75 H 32 SH 18 AH 26		Chrome	\$1512

Optional Glides: Add \$8.00 net per chair for a set of four (4).



**Amadeus Arm Chair
Tapered Four Leg Base**

	MODEL	LIST PRICE/ GRADE	COM/COL	A	B	C	D	E	F	G	H	I	J	K	L
3D Walnut veneer shell, upholstered seat onlay	AMA-3WU	Powder Coat	\$1562	1612	1639	1664	1689	1714	1741	1765	1791	1817	1842	1867	1894
		Chrome	\$1668	1720	1744	1769	1796	1820	1846	1872	1898	1922	1949	1973	1999

W 23.5 D 22 H 32
SH 19 H 26

COM Yardage: 1 or 2 seats: .75 yard
Contact Leland Customer Experience for yardage requirements on textiles with repeats.
Optional Glides: Add \$8.00 net per chair for a set of four (4).

To specify:
Please refer to pages 3-4 for complete specifying information.
Specify all products by their product code.

AMADEUS SIDE CHAIR, POLY SHELL, WOOD BASE
 Design: Martin Ballendat

AM11

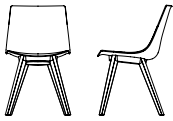

Amadeus Side Chair

Wood Base	MODEL	FRAME FINISH	LIST PRICE
Polypropylene shell	AMSW-PO		\$750
W 19 D 22 H 32 SH 18		Optional Glides: Add \$8.00 net per chair for a set of four (4).	

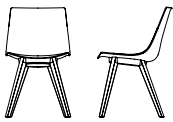

Amadeus Side Chair

Wood Base	MODEL	LIST PRICE/GRADE	COM/COL	A	B	C	D	E	F	G	H	I	J	K	L
Polypropylene shell, upholstered seat onlay	AMSW-PU		\$762	801	820	840	859	879	898	918	937	957	976	995	1015
W 19 D 22 H 32 SH 19		COM Yardage: 1 or 2 seats: .75 yard													
		Contact Leland Customer Experience for yardage requirements on textiles with repeats.													
		Optional Glides: Add \$8.00 net per chair for a set of four (4)													

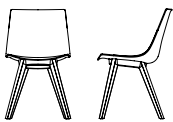

Amadeus Side Chair

Wood Base	MODEL	LIST PRICE/ GRADE	COM/COL	A	B	C	D	E	F	G	H	I	J	K	L
Fully upholstered	AMSW-FU		\$1162	1256	1303	1349	1396	1444	1491	1537	1585	1631	1677	1724	1722
W 19 D 22 H 32.5 SH 18		COM Yardage: 1 seat: 1.5 yards													
		Contact Leland Customer Experience for yardage requirements on textiles with repeats.													
		Optional Glides: Add \$8.00 net per chair for a set of four (4)													

To specify:
 Please refer to pages 3-4 for complete specifying information.
 Specify all products by their product code.

Pricing Effective: July 2021

AMADEUS SIDE CHAIR, WOOD BASE
Design: Martin Ballendat

AM12

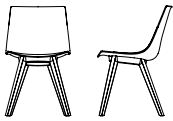

**Amadeus Side Chair
Wood Base**

	MODEL	FRAME FINISH	LIST PRICE
3D beech veneer shell	AMSW-3DB		\$1603
W 19 D 22 H 32 SH 18		Optional Glides: Add \$8.00 net per chair for a set of four (4).	

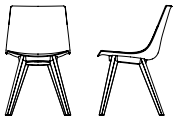

**Amadeus Side Chair
Wood Base**

	MODEL	LIST PRICE/ GRADE	COM/ COL	A	B	C	D	E	F	G	H	I	J	K	L
3D beech veneer shell, upholstered seat onlay	AMSW-3BU		\$1744	1788	1809	1833	1854	1877	1900	1922	1944	1967	1989	2011	2034
W 19 D 22 H 32 SH 18		COM Yardage: 1 or 2 seats: .75 yard Contact Leland Customer Experience for yardage requirements on textiles with repeats. Optional Glides: Add \$8.00 net per chair for a set of four (4)													

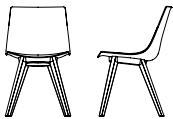

**Amadeus Side Chair
Wood Base**

	MODEL	FRAME FINISH	LIST PRICE
3D american walnut veneer shell	AMSW-3DW		\$1931
W 19 D 22 H 32 SH 18		Optional Glides: Add \$8.00 net per chair for a set of four (4).	

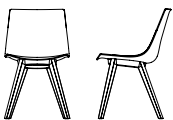

**Amadeus Side Chair
Wood Base**

	MODEL	LIST PRICE/ GRADE	COM/ COL	A	B	C	D	E	F	G	H	I	J	K	L
3D american walnut veneer shell, upholstered seat onlay	AMSW-3WU		\$2070	2115	2138	2160	2182	2205	2227	2249	2273	2294	2317	2339	2362
W 19 D 22 H 32 SH 18		COM Yardage: 1 or 2 seats: .75 yard Contact Leland Customer Experience for yardage requirements on textiles with repeats. Optional Glides: Add \$8.00 net per chair for a set of four (4)													

To specify:
Please refer to pages 3-4 for
complete specifying information.
Specify all products by their
product code.

Pricing Effective: February 2022

AMADEUS COUNTER CHAIR, SLED BASE

Design: Martin Ballendat

AM13

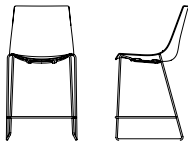

Amadeus Counter Chair, Sled Base

	MODEL	FRAME FINISH	LIST PRICE
Polypropylene shell	AMCS-PO	Powder Coat	\$565
W 20.5 D 21.5 H 38.5 SH 26		Chrome	\$632

Optional Glides: Add \$8.00 net per chair for a set of four (4).

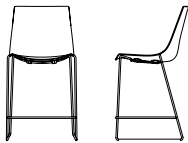

Amadeus Counter Chair, Sled Base

	MODEL	LIST PRICE/GRADE	COM/COL	A	B	C	D	E	F	G	H	I	J	K	L
Polypropylene shell, upholstered seat onlay	AMCS-PU	Powder Coat	\$687	726	746	765	785	804	824	843	862	882	901	921	940
		Chrome	\$754	793	813	832	852	871	891	910	930	949	968	988	1007

W 20.5 D 21.5 H 38.5 SH 26

COM Yardage: 1 or 2 seats: .75 yard
 Contact Leland Customer Experience for yardage requirements on textiles with repeats.
 For COL requirements please contact Leland Customer Experience.
 Optional Glides: Add \$8.00 net per chair for a set of four (4).

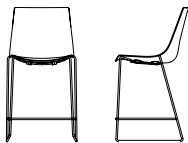

Amadeus Counter Chair, Sled Base

	MODEL	LIST PRICE/GRADE	COM/ COL	A	B	C	D	E	F	G	H	I	J	K	L
Fully upholstered	AMCS-FU	Powder Coat	\$818	900	941	982	1023	1064	1105	1146	1187	1227	1267	1308	1349
		Chrome	\$888	970	1011	1052	1093	1134	1175	1216	1257	1298	1339	1379	1420

W 20.5 D 21.5 H 38.5 SH 26

COM Yardage: 1 seat: 1.5 yards
 Contact Leland Customer Experience for yardage requirements on textiles with repeats.
 For COL requirements please contact Leland Customer Experience.
 Optional Glides: Add \$8.00 net per chair for a set of four (4).

To specify:
 Please refer to pages 3-4 for
 complete specifying information.
 Specify all products by their
 product code.

Pricing Effective: July 2021

AMADEUS COUNTER CHAIR, SLED BASE
Design: Martin Ballendat

AM14

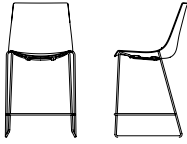

**Amadeus Counter Chair,
Sled Base**

	MODEL	FRAME FINISH	LIST PRICE
3D Beech veneer shell	AMCS-3DB	Powder Coat	\$1104
W 21 D 21.5 H 38.5 SH 26		Chrome	\$1171

Optional Glides: Add \$8.00 net per chair for a set of four (4).

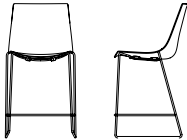

**Amadeus Counter Chair,
Sled Base**

	MODEL	LIST PRICE/ GRADE	COM/COL	A	B	C	D	E	F	G	H	I	J	K	L
3D Beech veneer shell, upholstered seat onlay	AMCS-3BU	Powder Coat	\$1226	1265	1284	1304	1323	1343	1362	1382	1401	1421	1440	1459	1479
		Chrome	\$1293	1332	1351	1371	1390	1410	1429	1449	1468	1488	1507	1526	1546

W 20.5 D 21.5 H 38.5 SH 26

COM Yardage: 1 or 2 seats: .75 yard
Contact Leland Customer Experience for yardage requirements on textiles with repeats.
Optional Glides: Add \$8.00 net per chair for a set of four (4).

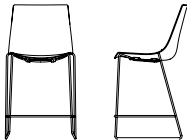

**Amadeus Counter Chair,
Sled Base**

	MODEL	FRAME FINISH	LIST PRICE
3D Walnut veneer shell	AMCS-3DW	Powder Coat	\$1252
W 20.5 D 21.5 H 38.5 SH 26		Chrome	\$1318

Optional Glides: Add \$8.00 net per chair for a set of four (4).

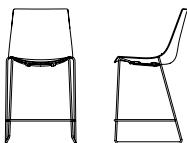

Amadeus Sled Base Chair

	MODEL	LIST PRICE/GRADE	COM/ COL	A	B	C	D	E	F	G	H	I	J	K	L
3D Walnut veneer shell, upholstered seat onlay	AMCS-3WU	Powder Coat	\$1374	1413	1432	1452	1471	1491	1510	1530	1549	1569	1588	1608	1627
		Chrome	\$1440	1479	1498	1518	1537	1557	1576	1596	1615	1635	1654	1674	1693

W 20.5 D 21.5 H 38.5 SH 26

COM Yardage: 1 or 2 seats: .75 yard
Contact Leland Customer Experience for yardage requirements on textiles with repeats.
Optional Glides: Add \$8.00 net per chair for a set of four (4).

To specify:
Please refer to pages 3-4 for complete specifying information.
Specify all products by their product code.

Pricing Effective: July 2021

AMADEUS COUNTER CHAIR, WOOD BASE
Design: Martin Ballendat

AM15

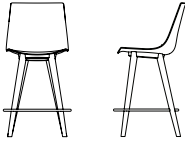

Amadeus Counter Chair

Wood Base

	MODEL	FRAME FINISH	LIST PRICE
Polypropylene shell	AMCW-PO		\$1158
W 20 D 22.5 H 40 SH 25.5		Optional Glides: Add \$8.00 net per chair for a set of four (4).	

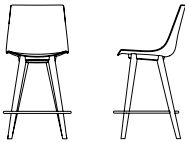

Amadeus Counter Chair

Wood Base

	MODEL	LIST PRICE/ GRADE	COM/ COL	A	B	C	D	E	F	G	H	I	J	K	L
Polypropylene shell, upholstered seat onlay	AMCW-PU		\$1288	1330	1351	1372	1393	1413	1435	1455	1476	1497	1518	1538	1560
W 20 D 22.5 H 40 SH 25.5			COM Yardage: 1 or 2 seats: .75 yard Contact Leland Customer Experience for yardage requirements on textiles with repeats. Optional Glides: Add \$8.00 net per chair for a set of four (4)												

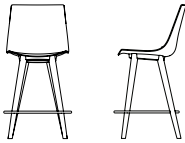

Amadeus Counter Chair

Wood Base

	MODEL	LIST PRICE/ GRADE	COM/ COL	A	B	C	D	E	F	G	H	I	J	K	L
Fully upholstered	AMCW-FU		\$1364	1446	1487	1528	1569	1610	1651	1692	1733	1773	1814	1855	1896
W 20 D 22.5 H 40 SH 25.5			COM Yardage: 1 seat: 1.5 yards Contact Leland Customer Experience for yardage requirements on textiles with repeats. Optional Glides: Add \$8.00 net per chair for a set of four (4).												

To specify:
Please refer to pages 3-4 for complete specifying information.
Specify all products by their product code.

Pricing Effective: July 2021

AMADEUS COUNTER CHAIR, WOOD BASE
Design: Martin Ballendat

AM16

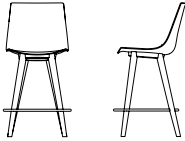

Amadeus Counter Chair

Wood Base

	MODEL	FRAME FINISH	LIST PRICE
3D Beech veneer shell	AMCW-3DB		\$1988
W 20 D 22.5 H 40 SH 25.5		Optional Glides: Add \$8.00 net per chair for a set of four (4).	

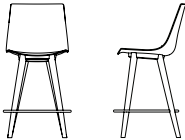

Amadeus Counter Chair

Wood Base

	MODEL	LIST PRICE/ GRADE	COM/ COL	A	B	C	D	E	F	G	H	I	J	K	L
3D Beech veneer shell, upholstered seat onlay	AMCW-3BU		\$2127	2173	2195	2217	2240	2262	2283	2307	2328	2351	2374	2396	2418
W 20 D 22.5 H 40 SH 26			COM Yardage: 1 or 2 seats: .75 yard Contact Leland Customer Experience for yardage requirements on textiles with repeats. Optional Glides: Add \$8.00 net per chair for a set of four (4)												

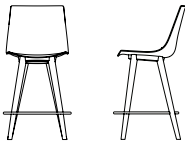

Amadeus Counter Chair

Wood Base

	MODEL	FRAME FINISH	LIST PRICE
3D American walnut veneer shell	AMCW-3DW		\$2259
W 20 D 22.5 H 40 SH 25.5		Optional Glides: Add \$8.00 net per chair for a set of four (4).	

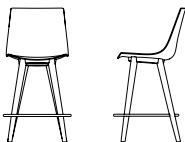

Amadeus Counter Chair

Wood Base

	MODEL	LIST PRICE/ GRADE	COM/ COL	A	B	C	D	E	F	G	H	I	J	K	L
3D American walnut veneer shell, upholstered seat onlay	AMCW-3WU		\$2398	2443	2465	2488	2510	2533	2554	2578	2599	2622	2645	2667	2689
W 20 D 22.5 H 40 SH 26			COM Yardage: 1 or 2 seats: .75 yard Contact Leland Customer Experience for yardage requirements on textiles with repeats. Optional Glides: Add \$8.00 net per chair for a set of four (4)												

To specify:

Please refer to pages 3-4 for complete specifying information. Specify all products by their product code.

Pricing Effective: February 2022

AMADEUS BAR CHAIR, SLED BASE
Design: Martin Ballendat

AM17

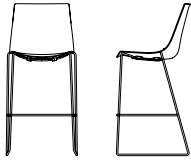

**Amadeus Bar Chair
Sled Base**

	MODEL	FRAME FINISH	LIST PRICE
Polypropylene shell	AMBS-PO	Powder Coat	\$642
W 20.5 D 21.5 H 43.75 SH 29		Chrome	\$700

Optional Glides: Add \$8.00 net per chair for a set of four (4).

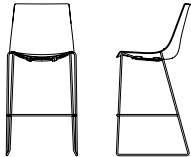

**Amadeus Bar Chair
Sled Base**

	MODEL	LIST PRICE/GRADE	COM/COL	A	B	C	D	E	F	G	H	I	J	K	L
Polypropylene shell upholstered seat onlay	AMBS-PU	Powder Coat	\$764	803	822	842	861	881	900	920	939	959	978	998	1017
		Chrome	\$822	861	881	900	920	939	959	978	998	1017	1037	1056	1076

W 21 D 21.5 H 44 SH 30

COM Yardage: 1 or 2 seats: .75 yard
Contact Leland Customer Experience for yardage requirements on textiles with repeats.
For COL requirements please contact Leland Customer Experience.
Optional Glides: Add \$8.00 net per chair for a set of four (4).

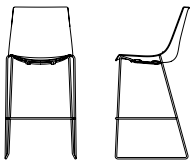

**Amadeus Bar Chair
Sled Base**

	MODEL	LIST PRICE/ GRADE	COM/COL	A	B	C	D	E	F	G	H	I	J	K	L
Fully upholstered	AMBS-FU	Powder Coat	\$899	981	1022	1063	1104	1145	1185	1225	1266	1307	1348	1389	1430
		Chrome	\$960	1042	1083	1124	1164	1205	1246	1287	1328	1369	1410	1451	1492

W 20.5 D 21.5 H 43.75
SH 29

COM Yardage: 1 seat: 1.5 yards
Contact Leland Customer Experience for yardage requirements on textiles with repeats.
For COL requirements please contact Leland Customer Experience.
Optional Glides: Add \$8.00 net per chair for a set of four (4).

To specify:
Please refer to pages 3-4 for complete specifying information.
Specify all products by their product code.

Pricing Effective: July 2021

AMADEUS BAR CHAIR, SLED BASE
Design: Martin Ballendat

AM18

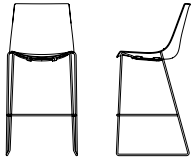

**Amadeus Bar Chair
Sled Base**

	MODEL	FRAME FINISH	LIST PRICE
3D Beech veneer shell	AMBS-3DB	Powder Coat	\$1180
W 20.5 D21.5 H 43.75 SH 29		Chrome	\$1238

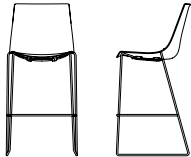

Optional Glides: Add \$8.00 net per chair for a set of four (4).

**Amadeus Bar Chair
Sled Base**

	MODEL	LIST PRICE/ GRADE	COM/COL	A	B	C	D	E	F	G	H	I	J	K	L
3D Beech veneer shell, upholstered onlay	AMBS-3BU	Powder Coat	\$1303	1342	1361	1380	1400	1419	1439	1458	1478	1497	1517	1536	1556
		Chrome	\$1360	1399	1418	1438	1457	1477	1496	1516	1535	1555	1574	1594	1613

W 21 D 21.5 H 44 SH 30

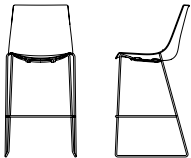

COM Yardage: 1 or 2 seats: .75 yard
Contact Leland Customer Experience for yardage requirements on textiles with repeats.
For COL requirements please contact Leland Customer Experience.
Optional Glides: Add \$8.00 net per chair for a set of four (4).

**Amadeus Bar Chair
Sled Base**

	MODEL	FRAME FINISH	LIST PRICE
3D Walnut veneer shell	AMBS-3DW	Powder Coat	\$1329
W 21 D21.5 H 44 SH 29.5		Chrome	\$1386

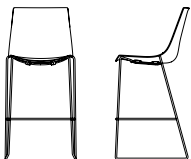

Optional Glides: Add \$8.00 net per chair for a set of four (4).

**Amadeus Bar Chair
Sled Base**

	MODEL	LIST PRICE/ GRADE	COM/ COL	A	B	C	D	E	F	G	H	I	J	K	L
3D Walnut veneer shell upholstered seat onlay	AMBS-3WU	Powder Coat	\$1451	1490	1509	1529	1548	1568	1587	1607	1626	1645	1665	1684	1704
		Chrome	\$1508	1547	1567	1586	1605	1625	1644	1664	1683	1703	1722	1742	1761

W 21 D 21.5 H 44 SH 30

To specify:

Please refer to pages 3-4 for complete specifying information. Specify all products by their product code.

COM Yardage: 1 or 2 seats: .75 yard
Contact Leland Customer Experience for yardage requirements on textiles with repeats.
For COL requirements please contact Leland Customer Experience.
Optional Glides: Add \$8.00 net per chair for a set of four (4).

AMADEUS BAR CHAIR, WOOD BASE
Design: Martin Ballendat

AM19



Amadeus Bar Chair

Wood Base

	MODEL	FRAME FINISH	LIST PRICE
Polypropylene shell	AMBW-PO		\$1257
W 20 D 22.5 H 44 SH 29		Optional Glides: Add \$8.00 net per chair for a set of four (4).	



Amadeus Bar Chair

Wood Base

	MODEL	LIST PRICE/ GRADE	COM/ COL	A	B	C	D	E	F	G	H	I	J	K	L
Polypropylene shell upholstered seat onlay	AMBW-PU		\$1379	1418	1438	1457	1477	1496	1516	1535	1555	1574	1594	1613	1632
W 20 D 22.5 H 44 SH 29.5		COM Yardage: 1 or 2 seats: .75 yard Contact Leland Customer Experience for yardage requirements on textiles with repeats. Optional Glides: Add \$8.00 net per chair for a set of four (4)													



Amadeus Bar Chair

Wood Base

	MODEL	LIST PRICE/ GRADE	COM/ COL	A	B	C	D	E	F	G	H	I	J	K	L
Fully upholstered	AMBW-FU		\$1545	1626	1667	1708	1749	1790	1831	1872	1913	1954	1995	2036	2076
W 20 D 22.5 H 44 SH 29.5		COM Yardage: 1 seat: 1.5 yards Contact Leland Customer Experience for yardage requirements on textiles with repeats. Optional Glides: Add \$8.00 net per chair for a set of four (4)													

To specify:
Please refer to pages 3-4 for
complete specifying information.
Specify all products by their
product code.

Pricing Effective: July 2021

AMADEUS BAR CHAIR, WOOD BASE
Design: Martin Ballendat

AM20



Amadeus Bar Chair

Wood Base

	MODEL	FRAME FINISH	LIST PRICE
3D beech veneer shell	AMBW-3DB		\$2183
W 20 D 22.5 H 44 SH 29		Optional Glides: Add \$8.00 net per chair for a set of four (4).	

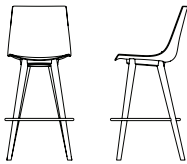

Amadeus Bar Chair

Wood Base

	MODEL	LIST PRICE/ GRADE	COM/ COL	A	B	C	D	E	F	G	H	I	J	K	L
3D beech veneer shell upholstered seat onlay	AMBW-3BU	\$2324		2368	2391	2413	2435	2459	2480	2503	2525	2548	2569	2592	2614
W 20 D 22.5 H 44 SH 29.5		COM Yardage: 1 or 2 seats: .75 yard Contact Leland Customer Experience for yardage requirements on textiles with repeats. Optional Glides: Add \$8.00 net per chair for a set of four (4)													



Amadeus Bar Chair

Wood Base

	MODEL	FRAME FINISH	LIST PRICE
3D american walnut veneer shell	AMBW-3DW		\$2511
W 20 D 22.5 H 44 SH 29		Optional Glides: Add \$8.00 net per chair for a set of four (4).	



Amadeus Bar Chair

Wood Base

	MODEL	LIST PRICE/ GRADE	COM/ COL	A	B	C	D	E	F	G	H	I	J	K	L
3D american walnut veneer shell, upholstered seat onlay	AMBW-3WU	\$2652		2697	2719	2740	2764	2785	2808	2829	2853	2875	2897	2920	2942
W 20 D 22.5 H 44 SH 29.5		COM Yardage: 1 or 2 seats: .75 yard Contact Leland Customer Experience for yardage requirements on textiles with repeats. Optional Glides: Add \$8.00 net per chair for a set of four (4)													

To specify:

Please refer to pages 3-4 for complete specifying information. Specify all products by their product code.

Pricing Effective: February 2022

AMADEUS TRANSPORT/STACKING DOLLY

Design: Martin Ballendat

AM21

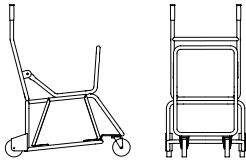

Amadeus

Sled Base

Transport/Stacking Dolly

MODEL

FRAME FINISH

LIST PRICE

Black powder coat finish

AMD-SB

\$757

W 23.5 D37.5 H 43
(Dimensions of dolly when empty)

Sled Base: 20 high on dolly (15 high on floor)

For use with all Amadeus sled base, side chairs with poly shells, wood shells, and upholstered only

**Arm, Counter, & Bar models do not stack

W 23.5 D37.5 H 70
(Dimensions with 20 poly or wood shell chairs stacked)

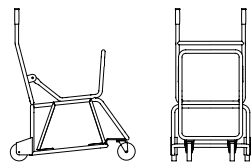

Amadeus

Four Leg Base

Transport/Stacking Dolly

MODEL

FRAME FINISH

LIST PRICE

Black powder coat finish

AMD-4L

\$1010

W 23.5 D37.5 H 43
(Dimensions of dolly when empty)

Four Leg Base: 12 high on dolly

For use with all shell types

**Arm, Counter, & Bar models do not stack

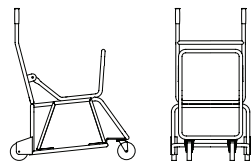

Amadeus

Four Leg Base

Transport/Stacking Dolly

MODEL

FRAME FINISH

LIST PRICE

Black powder coat finish

AMD-SBFU

\$1250

W 23.5 D37.5 H 78
(Dimensions with 20 fully upholstered chairs stacked)

Sled Base: 20 high on dolly (15 high on floor)

For use with fully upholstered shell only

**Arm, Counter, & Bar models do not stack

To specify:

Please refer to pages 3-4 for complete specifying information.

Specify all products by their product code.

Pricing Effective: July 2021

5695 Eagle Drive, SE
Grand Rapids,
Michigan 49512
616-975-9260
lelandfurniture.com

freshcoast collection
BEACH STONES

2021 Price List

Pricing Effective July 2021



freshcoast
by LELAND

beach stones price list

+ beach stones: table of contents..... BSC2
+ beach stones specification information BSC3
+ beach stones specification example..... BSC4
+ beach stones seating BSC5
+ beach stone table..... BSC6

model

DESCRIPTION	CODE
Beach Stone E	BSE
Beach Stone F	BSF
Beach Stone G	BSG
Beach Stone H	BSH
Beach Stone I	BSI
Beach Stone J	BSJ
Beach Stone K	BSK
Beach Stone L	BSL

upholstery selection

Please refer to freshcoast Textile Program which features textiles and leathers from the following partners:

- Camira
- Carnegie
- CF Stinson
- Green Hides
- Maharam
- Unika Vaev

The complete grade list can be found at www.fc.studio/textile-partners or you can specify COM/COL. Due to the design of this product, it is recommended that all non pre-approved textile be tested for compatibility. Contact freshcoast for yardage requirements on textiles with repeats.

base finish

Black textured powder coat

table top finish

SOLID SURFACE

DESCRIPTION	CODE
Black Corian®	CB
White Corian®	CW
Grey Corian®	CG

GLASS

DESCRIPTION	CODE
Black Back painted Glass	BG
Grey Back painted Glass	GG
White Back painted Glass	WG

SPECIFICATIONS REQUIRED TO CREATE THE PRODUCT CODE

- + Model
- + Upholstery Selection
- + Table Top Finish (when applicable)

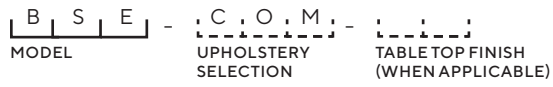

model

Beach Stone E (BSE)

upholstery selection

Upholstered (COM)



TABLE TOP FINISH

When applicable

seating



beach stone e	model	com/col	a	b	c	d	e	f	g	h	i	j	k	l
fully upholstered	BSE	\$1310	1465	1543	1621	1699	1777	1855	1933	2011	2088	2166	2244	2322
W32 D24 H25 SH18		COM yardage: 2.5 yds. Contact freshcoast customer care for COL requirements, textile testing requirements and yardage requirements for textiles with repeats.												



beach stone F	model	com/col	a	b	c	d	e	f	g	h	i	j	k	l
fully upholstered	BSF	\$1288	1444	1522	1600	1677	1755	1833	1911	1989	2067	2145	2222	2300
W32 D24 H26 SH18		COM yardage: 2.5 yds. Contact freshcoast customer care for COL requirements, textile testing requirements and yardage requirements for textiles with repeats.												

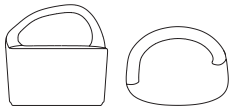

beach stone G	model	com/col	a	b	c	d	e	f	g	h	i	j	k	l
fully upholstered	BSG	\$1304	1460	1538	1616	1694	1771	1849	1927	2005	2083	2161	2239	2317
W32 D24 H31 SH18		COM yardage: 2.5 yds. Contact freshcoast customer care for COL requirements, textile testing requirements and yardage requirements for textiles with repeats.												



beach stone H	model	com/col	a	b	c	d	e	f	g	h	i	j	k	l
fully upholstered	BSH	\$868	1024	1102	1180	1258	1336	1414	1491	1569	1647	1725	1803	1881
W48 D18 H18		COM yardage: 2.5 yds. Contact freshcoast customer care for COL requirements, textile testing requirements and yardage requirements for textiles with repeats.												



beach stone I	model	com/col	a	b	c	d	e	f	g	h	i	j	k	l
fully upholstered	BSI	\$782	886	938	990	1041	1093	1145	1197	1249	1301	1353	1405	1457
W33 D22 H18		COM yardage: 1.75 yds. Contact freshcoast customer care for COL requirements, textile testing requirements and yardage requirements for textiles with repeats.												

to specify: please refer to pages 3-4 for complete specifying information. Specify all products by their product code.

tables

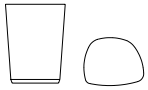

beach stone J	model	com/col	a	b	c	d	e	f	g	h	i	j	k	l
upholstered w/ Corian®	BSJ	\$914	966	992	1018	1044	1070	1096	1122	1147	1173	1199	1225	1251

W17 D13 H22

COM yardage: 1 yd.

Contact freshcoast customer care for COL requirements, textile testing requirements and yardage requirements for textiles with repeats.

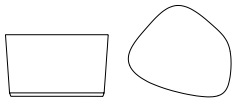

beach stone K	model	com/col	a	b	c	d	e	f	g	h	i	j	k	l
upholstered w/ Corian®	BSK	\$914	1018	1070	1122	1173	1225	1277	1329	1381	1433	1485	1537	1589

W30 D27 H18

COM yardage: 2 yds.

Contact freshcoast customer care for COL requirements, textile testing requirements and yardage requirements for textiles with repeats.

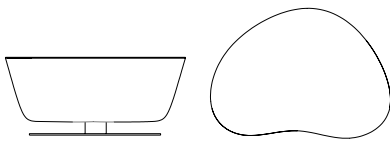

beach stone L	model	com/col	a	b	c	d	e	f	g	h	i	j	k	l
upholstered w/ Corian®	BSL	\$2859	3015	3093	3171	3249	3327	3405	3482	3560	3638	3716	3794	3872

W47 D34 H20

COM yardage: 3 yds.

Contact freshcoast customer care for COL requirements, textile testing requirements and yardage requirements for textiles with repeats.

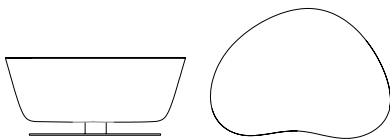

beach stone L	model	com/col	a	b	c	d	e	f	g	h	i	j	k	l
upholstered w/ backpainted glass	BSL	\$3120	3276	3354	3432	3509	3587	3665	3743	3821	3899	3977	4055	4132

W47 D34 H20

COM yardage: 3 yds.

Contact freshcoast customer care for COL requirements, textile testing requirements and yardage requirements for textiles with repeats.

to specify: please refer to pages 3-4 for complete specifying information. Specify all products by their product code.

pricing effective: July 2021

Brit Bench Metallic

July 2021 Price List

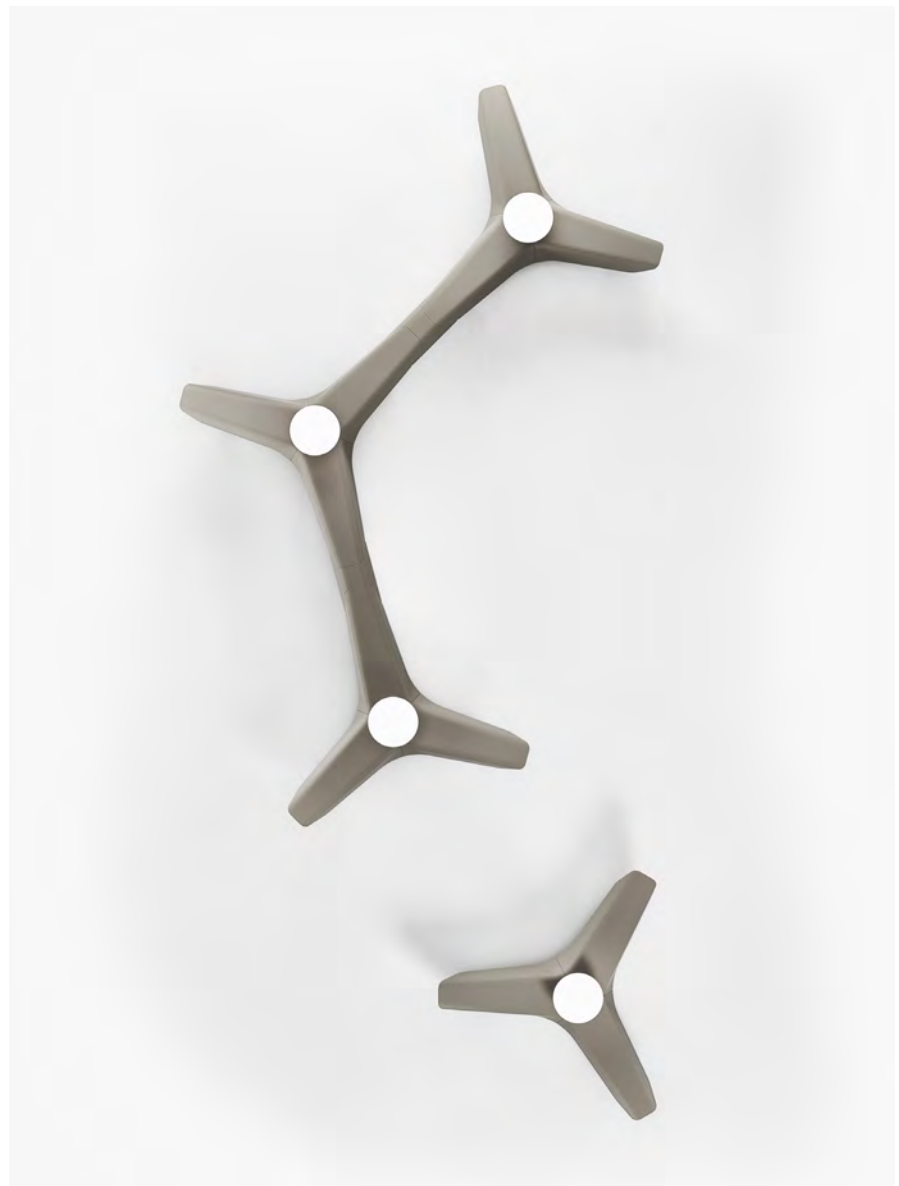

Brit Bench Metallic

Table of Contents	BBM2
Specification Information	BBM3
Specification Example	BBM4
Powder Coat Steel, Upholstered Seat Onlay	BBM5
Auxiliary Options	BBM6
Link Specification Information	BBM7
Link Specification Example	BBM8
Brit Bench Metallic Link	BBM9
Auxiliary Options	BBM10

Bench Model

DESCRIPTION	CODE
Brit Bench metallic powder coat steel	BBPC
Brit Bench metallic powder coat steel, with powder coat steel table	BBPCT
Brit Bench metallic powder coat steel, upholstered onlay	BBPCU with
Brit Bench metallic powder coat steel, with powder steel table, with upholstered onlay	BBPCTU coat

Leg Finish

DESCRIPTION	CODE
Brushed Stainless Steel	BSS
Black Powder Coat	BPC

Powder Coat Steel Finish

DESCRIPTION	CODE
Black Textured Powder Coat	BT
Grey Textured Powder Coat	GT
Soda Red Textured	SRT
Dolphin Textured	DLT
Oxford Textured	OXT
Tangerine Textured	TNT
Ice Blue Textured	IBT
Artic Textured	ART
Caribbean Textured	CBT
Limelight Textured	LLT
Ink Textured	IN

Upholstered Onlay Selection

Please refer to Leland Textile Program which features textiles and leathers from the following partners:

- Camira
- Carnegie
- CF Stinson
- Green Hides
- Maharam
- Unika Vaev

The complete grade list can be found on our website or you can specify COM/COL. Due to the design of this product, it is recommended that all non pre-approved textile be tested for compatibility.

Upholstered onlay is not an option for the Brit Bench Metallic link.

Table Top Surface

DESCRIPTION	CODE
Corian® Solid Surface Solid with 0.5" square edge	SSS

Contact Corian® Solid Surface for current solid and pattern availability. A custom quote is required for all solid surface. Please contact Leland Customer Experience to request a custom quote.

Auxiliary Options

DESCRIPTION	CODE
Brit Bench Electrical outlets, (with table)	BBE0
Brit Bench Floor Mount	BBFM
Brit Bench Security Pan	BSP
Outdoor Treatment	OT

Glides

Brit Bench glides are nylon.

Product Specification

Brit Bench product layout is required at the quotation stage and order stage to ensure accurate product specifications. Contact Leland Customer Experience for CAD symbols.

Shipment Detail

Please note that Brit Bench products will be shipped unassembled. Please contact Customer Experience if assembled shipment is desired as additional charges will apply.

Specifications required to create the product code

BRIT BENCH METALLIC (WITHOUT TABLE)

- Model
- Leg Finish
- Powder Coat Steel Finish (when applicable)
- Upholstery Selection (when applicable)
- Auxiliary Options (when applicable)



BRIT BENCH METALLIC (WITH TABLE)

- Model
- Leg Finish
- Powder Coat Steel Finish (when applicable)
- Upholstered Onlay Selection (when applicable)
- Table Top Surface
- Surface Color (when applicable)
- Auxiliary Options (when applicable)

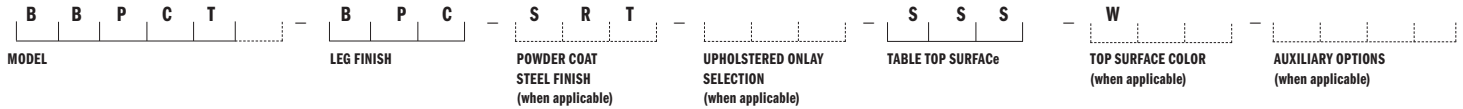

MODEL

Brit Bench Metallic Powder Coat Steel, with Powder Coat Steel Table (BBPCT)

LEG FINISH

Brushed Stainless Steel (BPC)

POWDER COAT STEEL FINISH

Soda Red Textured (SRT)

UPHOLSTERED ONLAY SELECTION

When applicable, enter upholstery grade, COM or COL

TABLE TOP SURFACE

SSS

TOP SURFACE COLOR

Corian® White Solid Surface (CW)

AUXILIARY OPTIONS

When applicable, enter auxiliary option code

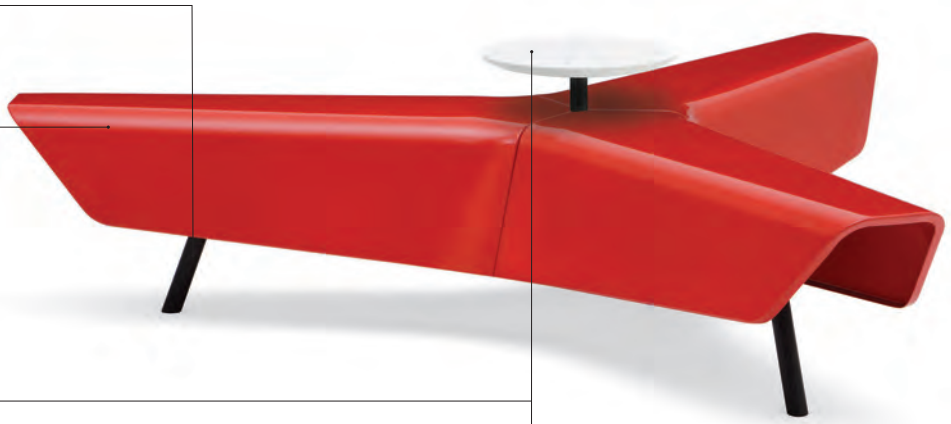

BRIT BENCH METALLIC POWDER COAT STEEL
Design: Simon Pengelly

BBM5



Brit Bench Metallic	MODEL	LIST PRICE
Powder coat steel	BBPC 1-3 units	\$8593
W 81 SH 18.5	BBPC 4+ units	\$7401

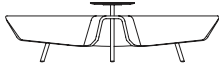

Brit Bench Metallic	MODEL	LIST PRICE
Powder coat steel, table	BBPC 1-3 units	\$9864
W 81 SH 18.5	BBPC 4+ units	\$8671

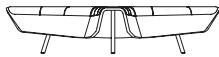

Brit Bench Metallic	MODEL	LIST PRICE/GRADE	COM/ COL	A	B	C	D	E	F	G	H	I	J	K	L
Powder coat steel upholstered seat onlay	BBPCU 1-3 units	\$9195	9459	9593	9725	9858	9992	10124	10257	10390	10523	10655	10789	10921	
	BBPCU 4+ units	\$8002	8267	8399	8532	8665	8798	8930	9064	9196	9329	9463	9595	9728	

W 81 SH 19.5

COM Yardage: 1 bench: 4 yards
For COL requirements please contact Leland Customer Experience.



Brit Bench Metallic	MODEL	LIST PRICE/ GRADE	COM/ COL	A	B	C	D	E	F	G	H	I	J	K	L
Powder coat steel, table upholstered seat onlay	BBPCTU 1-3 units	\$10463	10728	10861	10995	11127	11260	11393	11526	11658	11792	11924	12057	12189	
	BBPCTU 4+ units	\$9272	9536	9668	9802	9934	10067	10201	10333	10466	10599	10732	10864	10998	

W 81 SH 19.5

COM Yardage: 1 bench: 4 yards
For COL requirements please contact Leland Customer Experience.

Brit Bench Table Top	MODEL
Corian® Solid Surface Circular Top	SSS

Contact Corian® Solid Surface for current solid and pattern availability. A custom quote is required for all solid surface. Please contact Leland Customer Experience to request a custom quote.

To specify:
Please refer to pages 3-4 for complete specifying information. Specify all products by their product code.

Pricing Effective: July 2021

BRIT BENCH METALLIC AUXILIARY OPTIONS

Design: Simon Pengelly

BBM6

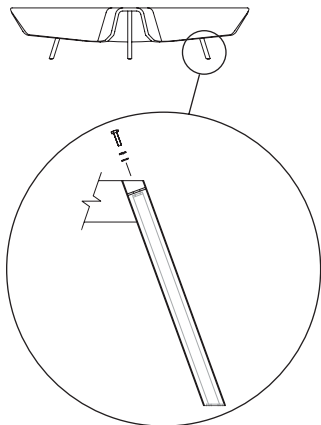

Brit Bench Floor Mount	MODEL	LIST PRICE
	BBFM	\$179

Due to the variety of floor surfaces on which the Brit Bench may be installed, floor mount fasteners are not supplied by Leland International. The Brit Bench floor mount feature consists of legs with floor mount brackets designed to use .3125 thread diameter fasteners. Responsibility of fastener choice is the customers. Brit Bench Floor Mount must be specified at the time of purchasing. The Floor Mount cannot be added later in the field.

Brit Bench Security Pan	MODEL	LIST PRICE
	BBSP	\$1500

Brit Bench Electrical Outlet	MODEL	LIST PRICE
For table	BBEO	\$993

Brit Bench electrical outlet option is not standard for all Brit Bench tables. Electrical outlet is located under the table edge, therefore a Brit Bench with table must be specified when specifying electrical outlet option. Brit Bench electrical outlet option features one 120v AC receptacle.

Outdoor Treatment	MODEL	LIST PRICE
powder coat steel bench	OT	\$331

To specify:
 Please refer to pages 3-4 for complete specifying information.
 Specify all products by their product code.

Pricing Effective: July 2021

Link Model

DESCRIPTION	CODE
Brit Bench Metallic Link powder coat steel	BBLPC

Powder Coat Steel Finish

DESCRIPTION	CODE
White Textured Powder Coat	WT
Black Textured Powder Coat	BT
Grey Textured Powder Coat	GT
Soda Red Textured	SRT
Dolphin Textured	DLT
Oxford Textured	OXT
Tangerine Textured	TNT
Ice Blue Textured	IBT
Artic Textured	ART
Caribbean Textured	CBT
Limelight Textured	LLT
Ink Textured	IN

Auxiliary Options

DESCRIPTION	CODE	DESCRIPTION	CODE
Brit Bench Link Security Pan			BBLSP
Outdoor Treatment			OT

Product Specification

Brit Bench product layout is required at the quotation stage and order stage to ensure accurate product specifications. Contact Leland Customer Experience for CAD symbols.

Shipment Details

Please note that Brit Bench products will be shipped unassembled.
Please contact Customer Experience if assembled shipment is desired as additional charges will apply.

Specifications required to create the product code

- Model
- Powder Coat Steel Finish (when applicable)
- Upholstery Selection (when applicable)
- Outdoor Treatment (when applicable)
- Auxiliary Options (when applicable)



MODEL

Brit Bench Metallic Link Powder Coat Steel (BBLPC)

POWDER COAT STEEL FINISH

Artic Textured (ART)

OUTDOOR TREATMENT

When applicable

AUXILIARY OPTIONS

When applicable, enter auxiliary option code



BRIT BENCH METALLIC LINK
Design: Simon Pengelly

BBM9

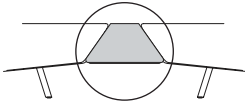

Brit Bench Metallic Link	MODEL	FRAME FINISH	LIST PRICE
powder coat steel link	BBLPC		\$1008

W 7.875

Upholstered onlay is not an option for the Brit Bench Metallic Powder Coat Steel Link.

To specify:
Please refer to pages 3-4 for complete specifying information.
Specify all products by their product code.

Pricing Effective: July 2021

Brit Bench Link Security Pan	MODEL	FRAME FINISH	LIST PRICE
	BBLSP		\$337

Brit Bench Link Security Pan must be specified at the time of purchasing.
The Link Security Pan cannot be added later in the field.

Outdoor Treatment	MODEL	FRAME FINISH	LIST PRICE
powder coat steel link	OT		\$111

To specify:
Please refer to pages 3-4 for
complete specifying information.
Specify all products by their
product code.

**5695 Eagle Drive, SE
Grand Rapids,
Michigan 49512
616-975-9260
lelandfurniture.com**

Café Parfait

July 2021 Price List



Café Parfait

Table of Contents	CP2
Specification Information	CP3
Specification Example	CP4
Side Chair	CP5
Counter Chair	CP6
Bar Chair	CP7
Transport/Stacking Dolly	CP8

Chair Model

DESCRIPTION	CODE
Café Parfait side chair, upholstered seat, wood back	CPSUW
Café Parfait side chair, wood seat, wood back	CPSWW
Café Parfait counter chair, upholstered seat, wood back	CPCUW
Café Parfait counter chair, wood seat, wood back	CPCWW
Café Parfait bar chair, upholstered seat, wood back	CPBUW
Café Parfait bar chair, wood seat, wood back	CPBWW

Upholstery Selection**POLYPROPYLENE SHELL:**

Please refer to Leland Textile Program which features textiles and leathers from the following partners:

- Camira
- Green Hides
- Carnegie
- Maharam
- CF Stinson
- Unika Vaev

The complete grade list can be found on our website or you can specify COM/COL. Due to the design of this product, it is recommended that all non pre-approved textile be tested for compatibility.

Seat and Back Wood Finish**STANDARD LELAND COLORS**

CUSTOM Specify Custom (01)

*Please note that Café Parfait is NOT AVAILABLE in the following finishes:

Natural Walnut Matte (08M), Natural Beech (09), Natural White Oak Matte (12M)

Frame Finishes

DESCRIPTION	CODE
Sterling	ST
Warm Grey	WG
Cool Grey	CG
Black	B
White	W
Matte Gold Rush	MGR
Matte Mercury	MMR
Matte Mineral	MMN
Matte Burnish	MBN
Matte Foundry	MFN
Matte New Penny	MNP

TEXTURED

Soda Red Textured	SRT
Dolphin Textured	DLT
Oxford Textured	OXT
Tangerine Textured	TNT
Ice Blue Textured	IBT
Artic Textured	ART
Caribbean Textured	CBT
Limelight Textured	LLT
Ink Textured	INT

Glide Type**STANDARD:**

DESCRIPTION	CODE
Nylon	S

OPTIONAL:

DESCRIPTION	CODE
Felt	FC
Floor Saver™ (for VCT type floors)	FS
Metal	M
Rubber	R

Please note that optional glides raise the chair height .5 inch.

Specifications required to create the product code

- Model
- Seat Upholstery or Finish
- Back Finish
- Frame Finish
- Glide Type



MODEL

Café Parfait Side Chair -
wood seat, wood back
(CPSWW)

SEAT UPHOLSTERY OR FINISH

Aegean (78)

BACK FINISH

Sea Grass (79)

FRAME FINISH

Sterling (ST)



CAFÉ PARFAIT SIDE CHAIR
 Design: Leland Design Group

CP5



Café Parfait Side Chair	MODEL	LIST PRICE
Wood seat wood back,	CPSWW	\$592
W 19 D 20 H 31 SH 19	Optional Glides: Add \$8.00 net per chair for a set of four (4). Optional Glides raise chair height .5 inch.	



Café Parfait Side Chair	MODEL	LIST PRICE/GRADE	COM/COL	A	B	C	D	E	F	G	H	I	J	K	L
3D Beech veneer shell, upholstered seat onlay	CPSUW		\$552	580	595	611	626	642	658	674	689	705	720	735	751
W 19 D 20 H 31 SH 19	Optional Glides: Add \$8.00 net per chair for a set of four (4). Optional Glides raise chair height .5 inch. COM Yardage: 1 or 2 seats: .75 yard; 3 or 4 seats: 1.25 yards Contact Leland Customer Experience for yardage requirements on textiles with repeats. For COL requirements please contact Leland Customer Experience.														

To specify:
 Please refer to pages 3-4 for
 complete specifying information.
 Specify all products by their
 product code.

Pricing Effective: July 2021

CAFÉ PARFAIT COUNTER CHAIR
 Design: Leland Design Group

CP6

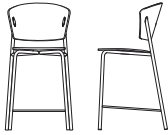

Café Parfait Counter Chair	MODEL	LIST PRICE
Wood seat wood back,	CPCWW	\$819

W 18.5 D 23 H 37.75 SH 25

Optional Glides: Add \$8.00 net per chair for a set of four (4). Optional Glides raise chair height .5 inch.

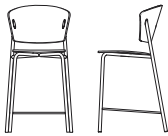

Café Parfait Counter Chair	MODEL	LIST PRICE/GRADE	COM/COL	A	B	C	D	E	F	G	H	I	J	K	L
3D Beech veneer shell, upholstered seat onlay	CPCUW		\$782	810	825	840	856	871	887	903	919	934	950	965	981

W 18.5 D 23 H 37.75
 SH 25.5

Optional Glides: Add \$8.00 net per chair for a set of four (4). Optional Glides raise chair height .5 inch.
 COM Yardage: 1 or 2 seats: .75 yard; 3 or 4 seats: 1.25 yards
 Contact Leland Customer Experience for yardage requirements on textiles with repeats.
 For COL requirements please contact Leland Customer Experience.

To specify:
 Please refer to pages 3-4 for
 complete specifying information.
 Specify all products by their
 product code.

Pricing Effective: July 2021

CAFÉ PARFAIT BAR CHAIR
 Design: Leland Design Group

CP7

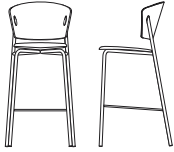

Café Parfait Bar Chair	MODEL	LIST PRICE
Wood seat wood back, W 19 D 20 H 43 SH 29.5	CPBWW	\$836

Optional Glides: Add \$8.00 net per chair for a set of four (4). Optional Glides raise chair height .5 inch.

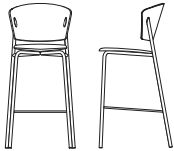

Café Parfait Bar Chair	MODEL	LIST PRICE/GRADE	COM/COL	A	B	C	D	E	F	G	H	I	J	K	L
3D Beech veneer shell, upholstered seat onlay W 19 D 20 H 43 SH 30	CPBUW		\$797	825	840	856	871	887	903	919	934	950	965	981	996

Optional Glides: Add \$8.00 net per chair for a set of four (4). Optional Glides raise chair height .5 inch.
 COM Yardage: 1 or 2 seats: .75 yard; 3 or 4 seats: 1.25 yards
 Contact Leland Customer Experience for yardage requirements on textiles with repeats.
 For COL requirements please contact Leland Customer Experience.

To specify:
 Please refer to pages 3-4 for
 complete specifying information.
 Specify all products by their
 product code.

Pricing Effective: July 2021

CAFÉ PARFAIT TRANSPORT/STACKING DOLLY
 Design: Leland Design Group

CP8

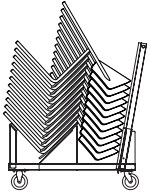

**Café Parfait Transport/
 Stacking Dolly**

	MODEL		LIST PRICE
57W 19 D 43 H 45 (Empty)	CPD	Black Finish	\$883
W 19 D 43 H 67 side chairs)	(With 10	Café Parfait Transport/Stacking Dolly handles up to 10 Café Parfait side chairs.	

To specify:
 Please refer to pages 3-4 for
 complete specifying information.
 Specify all products by their
 product code.

Pricing Effective: July 2021

**5695 Eagle Drive, SE
Grand Rapids,
Michigan 49512
616-975-9260
lelandfurniture.com**

Cambre Table

July 2021 Price List

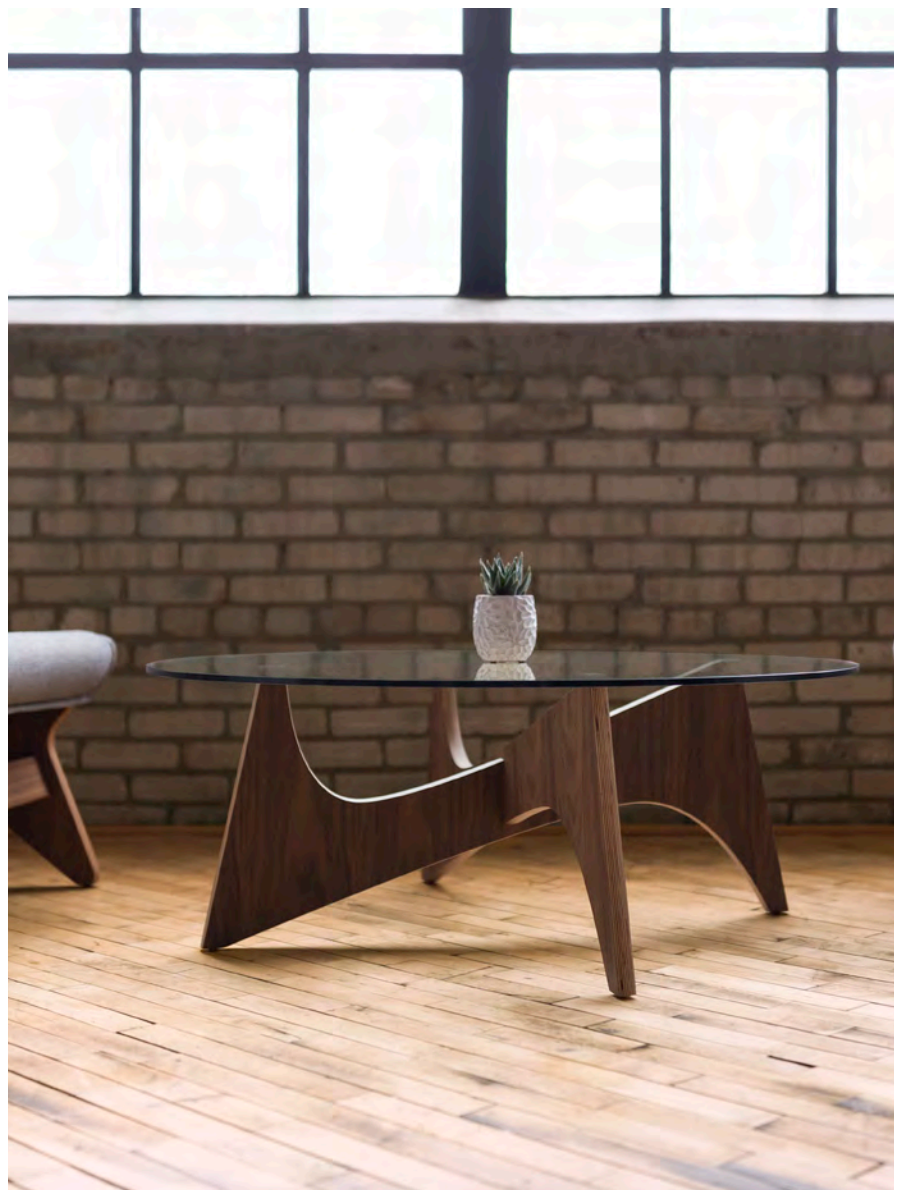

Cambre Table

Table of Contents	CA2
Specification Information	CA3
Specification Example	CA4
Table 16"	CA5
Table 22"	CA5

Table Model

DESCRIPTION	CODE
Cambre Table	CA

Table Height

DESCRIPTION	CODE
16"	16H
22"	22H

Base Finish

DESCRIPTION	CODE
Natural Walnut	08M
Natural Ash	07M

Maple in Standard Leland Colors

LELAND COLORS**Top Size**

DESCRIPTION	CODE
16" H Table	
42" Round	42D
34" Square	3434
22" H Table	
18" Round	18D
16" Square	1616

Top Surface Option

DESCRIPTION	CODE
16" H Table	
Clear Glass	G
22" H Table	
Clear Glass	G

Glide Selection

DESCRIPTION	CODE
Nylon (standard)	S
Felt	F

Specifications required to create the product code

- Model
- Table Height
- Base Finish Selection
- Top Size
- Top Surface
- Glide Selection

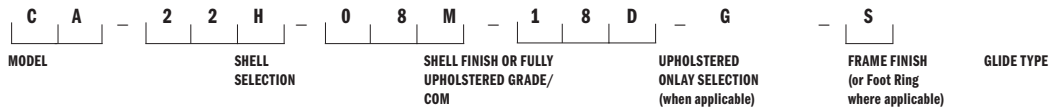

MODEL

Cambre Table (CA)

TABLE HEIGHT

22" (22H)

BASE FINISH

Natural Walnut (08M)

TOP SIZE

18" Round (18D)

TOP SURFACE

Glass (G)

GLIDE SELECTION

Nylon (S)



CAMBRE TABLE
Design: Bruce Sienkowski

CA5

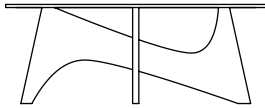

Cambre	MODEL	CLEAR GLASS
Cambre Occasional Table, 42" Round Top	CA-16H-42D	\$1997
W 42 D 42 H 16		

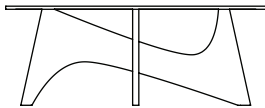

Cambre	MODEL	CLEAR GLASS
Cambre Occasional Table, 34" Square Top	CA-16H-3434	\$1579
W 34 D 34 H 16		

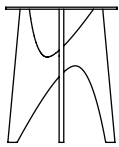

Cambre	MODEL	CLEAR GLASS
Cambre Side Table, 18" Round Top	CA-22H-18D	\$1592
W 18 D 18 H 22		

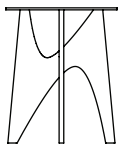

Cambre	MODEL	CLEAR GLASS
Cambre Side Table, 16" Square Top	CA-22H-1616	\$1254
W 16 D 16 H 22		

To specify:
Please refer to pages 3-4 for
complete specifying information.
Specify all products by their
product code.

Pricing Effective: July 2021

**5695 Eagle Drive, SE
Grand Rapids,
Michigan 49512
616-975-9260
lelandfurniture.com**

Ease

July 2021 Price List



Ease

Table of Contents	ES2
Specification Information	ES3
Specification Example	ES4
Side Chair	ES5
Transport/Stacking Dolly	ES7

Chair Model

DESCRIPTION	CODE
Ease side chair, upholstered seat, wood back	ESSUW
Ease side chair ganging, upholstered seat , wood back	ESSGUW
Ease side chair, upholstered seat, wood back upholstered back onlay	ESSUWU
Ease side chair ganging, upholstered seat wood back, upholstered back onlay	ESSGUWU
Ease side chair, wood seat, wood back	ESSWW
Ease side chair ganging, wood seat wood back	ESSGWW

Seat and Back Wood Finish**STANDARD LELAND COLORS****CUSTOM** Specify Custom (01)

*Please note that Ease is NOT AVAILABLE in the following finishes:

Upholstery Selection

Please refer to Leland Textile Program which features textiles and leathers from the following partners:

- Camira
- Carnegie
- CF Stinson
- Green Hides
- Maharam
- Unika Vaev

The complete grade list can be found on our website or you can specify COM/COL. Due to the design of this product, it is recommended that all non pre-approved textile be tested for compatibility.

Frame Finish: Powdercoat and Chrome

DESCRIPTION	CODE
Sterling	ST
Warm Grey	WG
Cool Grey	CG
Black	B
White	W
Matte Gold Rush	MGR
Matte Mercury	MMR
Matte Mineral	MMN
Matte Burnish	MBN
Matte Foundry	MFN
Matte New Penny	MNP
Chrome	C
Artic Textured	ART
Caribbean Textured	CBT
Limelight Textured	LLT
Ink Textured	INT

Auxiliary Options**GLIDES**

DESCRIPTION	CODE
Polycarbonate	P
Felt	F

Please note that adding glides raises the chair height.25 inch.

Specifications required to create the product code

- Model
- Seat Upholstery or Finish
- Back Finish
- Upholstered Back Onlay (when applicable)
- Frame Finish
- Auxiliary Options (when applicable)



MODEL

Ease Side Chair, upholstered seat, wood back, upholstered back onlay (ESSUWU)

SEAT UPHOLSTERY OR FINISH

Grade H (H)

BACK FINISH

Natural (11)

UPHOLSTERED BACK ONLAY

Grade H (H)

FRAME FINISH

Chrome (C)



EASE SIDE CHAIR
Design: Leland Design Group

ES5



Ease Side Chair

	MODEL	LIST PRICE/GRADE	COM/COL	A	B	C	D	E	F	G	H	I	J	K	L
Upholstered seat, wood back	ESSUW		\$531	560	574	589	604	618	633	648	663	677	692	707	721
W 19.5 D 21.75 H 31 SH 18.5															
Glides: Add \$8.00 net per chair for a set of four (4). COM Yardage: 1 or 2 seats: .75 yard, 3 or 4 seats: 1.5 yards, 5 or 6 seats: 2.25 yards. Contact Leland Customer Experience for yardage requirements on textiles with repeats. For COL requirements please contact Leland Customer Experience.															



Ease Side Chair, Ganging

	MODEL	LIST PRICE/GRADE	COM/COL	A	B	C	D	E	F	G	H	I	J	K	L
Upholstered seat, wood back	ESSGUW		\$574	603	617	632	647	662	676	691	706	720	735	750	764
W 19.5 D 21.75 H 31 SH 18.5															
Glides: Add \$8.00 net per chair for a set of four (4). COM Yardage: 1 or 2 seats: .75 yard, 3 or 4 seats: 1.5 yards, 5 or 6 seats: 2.25 yards. Contact Leland Customer Experience for yardage requirements on textiles with repeats. For COL requirements please contact Leland Customer Experience.															



Ease Side Chair

	MODEL	LIST PRICE/GRADE	COM/COL	A	B	C	D	E	F	G	H	I	J	K	L
Upholstered seat, wood back upholstered back onlay	ESSUWU		\$563	591	606	621	635	650	665	679	694	709	723	738	754
W 19.5 D 21.75 H 31 SH 18.5															
Glides: Add \$8.00 net per chair for a set of four (4). COM Yardage: 1 seat and back: .75 yard, 6 seats and backs: 3.5 yards Contact Leland Customer Experience for yardage requirements on textiles with repeats. For COL requirements please contact Leland Customer Experience.															



Ease Side Chair, Ganging

	MODEL	LIST PRICE/GRADE	COM/COL	A	B	C	D	E	F	G	H	I	J	K	L
Upholstered seat, wood back upholstered back onlay	ESSGUWU		\$667	695	710	725	740	755	770	784	799	814	828	843	858
W 19.5 D 21.75 H 31 SH 18.5															
Glides: Add \$8.00 net per chair for a set of four (4). COM Yardage: 1 seat and back: .75 yard, 6 seats and backs: 3.5 yards Contact Leland Customer Experience for yardage requirements on textiles with repeats. For COL requirements please contact Leland Customer Experience.															

To specify:
Please refer to pages 3-4 for complete specifying information.
Specify all products by their product code.

Pricing Effective: July 2021

EASE SIDE CHAIR
Design: Leland Design Group

ES6

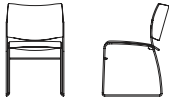

Ease Side Chair	MODEL	LIST PRICE
Wood seat wood back,	ESSWW	\$545
W 19.5 D 21.75 H 31 SH 18	Glides: Add \$8.00 net per chair for a set of four (4).	



Ease Side Chair, Ganging	MODEL	LIST PRICE
Wood seat wood back,	ESSGWW	\$574
W 19.5 D 21.75 H 31 SH 18	Glides: Add \$8.00 net per chair for a set of four (4).	

To specify:
Please refer to pages 3-4 for
complete specifying information.
Specify all products by their
product code.

Pricing Effective: July 2021

EASE TRANSPORT/STACKING DOLLY
Design: Leland Design Group

ES7

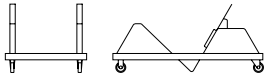

**Ease Transport/
Stacking Dolly**

	MODEL	LIST PRICE
W 22.75 D 46.5 H 14.25 (empty)	ESSNDB	\$942

Ease Transport/Stacking Dolly handles up to 25 side chairs in wood or 15 side chairs upholstered.

To specify:
Please refer to pages 3-4 for
complete specifying information.
Specify all products by their
product code.

Pricing Effective: July 2021

5695 Eagle Drive, SE
Grand Rapids,
Michigan 49512
616-975-9260
lelandfurniture.com

Ebb Bench Fully Upholstered

July 2021 Price List



Ebb Fully Upholstered

Table of Contents	EB2
Specification Information	EB3
Specification Example	EB4
Two Closed Ends	EB5
One Linking End	EB6
Two Linking Ends	EB7
Auxiliary Options	EB8
Hub Specification Information	EB9
Hub Specification Example	EB10
Hub	EB11
Hub Auxiliary Options	EB12
Pod Specification Information	EB13
Pod Specification Example	EB14
Pod	EB15
Pod Auxiliary Options	EB16

Bench Model

DESCRIPTION	CODE
Ebb fully upholstered bench, two closed ends	EBFUCC
Ebb fully upholstered bench, one linking end	EBFUCL
Ebb fully upholstered bench, two linking ends	EBFULL

Bench Length

DESCRIPTION	CODE
30" Long	30
48" Long	48
72" Long	72
96" Long	96
120" Long	120

Fully Upholstered Selection

Please refer to Leland Textile Program which features textiles and leathers from the following partners:

- Camira
- Carnegie
- CF Stinson
- Green Hides
- Maharam
- Unika Vaev

The complete grade list can be found at www.lelandfurniture.com/resources or you can specify COM/COL. All non pre-approved textiles need be tested for compatibility.

Due to upholstery requirements, the Ebb product line can only be upholstered railroaded. Please consider when specifying textiles with a pattern. Untested COM or COL textiles will not be accepted.

Leg Finish

Ebb fully upholstered linking benches have black powder coat skirts.

DESCRIPTION	CODE
Sterling	ST
Warm Grey	WG
Cool Grey	CG
Black	B
White	W
Matte Gold Rush	MGR
Matte Mercury	MMR
Matte Mineral	MMN
Matte Burnish	MBN
Matte Foundry	MFN
Matte New Penny	MNP
Black Textured	BT
Grey Textured	GT
White Textured	WT
Chrome	C

Auxiliary Options

Auxiliary Options must be specified at the time of the order.

SKIRT:

DESCRIPTION	CODE
Ebb Fully Upholstered Bench Skirt	SK

FLOOR MOUNT:

DESCRIPTION	CODE
Ebb Fully Upholstered Bench Floor Mount	FM
*Floor Mount requires Skirt.	

Glides

Ebb glides are nylon

Product Specification

Ebb layout is required at the quotation stage and order stage to ensure accurate product specifications. Contact Leland Customer Experience for CAD drawings.

Specifications required to create the product code

- Model
- Bench Length
- Upholstery Selection
- Leg Finish
- Skirt (when applicable)
- Floor Mount (when applicable)



MODEL

Ebb Fully Upholstered Bench
Two Closed Ends (EBFUCC)

BENCH LENGTH

72" (72)

UPHOLSTERY SELECTION

Enter upholstery grade,
COM or COL (COM)

LEG FINISH

Specify Standard Powder Coat

SKIRT

When Applicable, enter skirt code

FLOOR MOUNT

When Applicable, enter Ebb floor
mount code. Floor Mount requires Skirt.



EBB FULLY UPHOLSTERED BENCH TWO CLOSED ENDS

Design: Mark Gabbartas

EB5

Ebb Fully Upholstered Bench Two Closed Ends Skirt must be specified at the time of ordering. Skirt cannot be added later in the field.



Ebb Fully Upholstered Bench

Two Closed Ends

	MODEL	LIST PRICE/GRADE	COM/COL	A	B	C	D	E	F	G	H	I	J	K	L
30" long	EBFUCC-30		\$1974	2148	2270	2396	2526	2659	2797	2939	3085	3235	3390	3550	3714

W 17.5 L 18.5

COM Yardage: 1.75 yards
For COL requirements please contact Leland Customer Care.



Ebb Fully Upholstered Bench

Two Closed Ends

	MODEL	LIST PRICE/GRADE	COM/COL	A	B	C	D	E	F	G	H	I	J	K	L
48" long	EBFUCC-48		\$2600	2844	3012	3186	3364	3548	3737	3932	4133	4340	4553	4773	4999

W 17.5 L 18.5

COM Yardage: 2.75 yards
For COL requirements please contact Leland Customer Care.

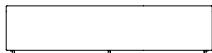

Ebb Fully Upholstered Bench

Two Closed Ends

	MODEL	LIST PRICE/GRADE	COM/COL	A	B	C	D	E	F	G	H	I	J	K	L
72" long	EBFUCC-72		\$3227	3531	3740	3956	4178	4406	4642	4884	5134	5392	5657	5930	6211

W 17.5 L 18.5

COM Yardage: 4.25 yards
For COL requirements please contact Leland Customer Care.



Ebb Fully Upholstered Bench

Two Closed Ends

	MODEL	LIST PRICE/GRADE	COM/COL	A	B	C	D	E	F	G	H	I	J	K	L
96" long	EBFUCC-96		\$3853	4238	4500	4770	5048	5335	5630	5934	6247	6570	6902	7244	7597

W 17.5 L 18.5

COM Yardage: 5.5 yards
For COL requirements please contact Leland Customer Care.



Ebb Fully Upholstered Bench

Two Closed Ends

	MODEL	LIST PRICE/GRADE	COM/COL	A	B	C	D	E	F	G	H	I	J	K	L
120" long	EBFUCC-120		\$4480	4942	5255	5578	5910	6252	6604	6967	7340	7725	8122	8530	8950

W 17.5 L 18.5

COM Yardage: 7 yards
For COL requirements please contact Leland Customer Care.

To specify:

Please refer to pages 3-4 for complete specifying information. Specify all products by their product code.

Pricing Effective: July 2021

EBB FULLY UPHOLSTERED BENCH ONE LINKING END
 Design: Mark Gabbartas

EB6



**Ebb Fully Upholstered Bench
 One Linking End**

	MODEL	LIST PRICE/GRADE	COM/COL	A	B	C	D	E	F	G	H	I	J	K	L
30" long	EBFUCL-30		\$2009	2184	2307	2434	2565	2700	2839	2982	3130	3281	3438	3599	3765

W 17.5 L 18.5

COM Yardage: 1.75 yards
 For COL requirements please contact Leland Customer Care.
 Unit comes with skirt.

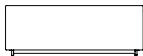

**Ebb Fully Upholstered Bench
 One Linking End**

	MODEL	LIST PRICE/GRADE	COM/COL	A	B	C	D	E	F	G	H	I	J	K	L
48" long	EBFUCL-48		\$2636	2881	3050	3224	3404	3589	3779	3976	4178	4386	4601	4822	5049

W 17.5 L 18.5

COM Yardage: 2.75 yards
 For COL requirements please contact Leland Customer Care.
 Unit comes with skirt.

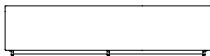

**Ebb Fully Upholstered Bench
 One Linking End**

	MODEL	LIST PRICE/GRADE	COM/COL	A	B	C	D	E	F	G	H	I	J	K	L
72" long	EBFUCL-72		\$3261	3566	3776	3993	4216	4446	4682	4926	5177	5436	5702	5977	6260

W 17.5 L 18.5

COM Yardage: 4.25 yards
 For COL requirements please contact Leland Customer Care.
 Unit comes with skirt.



**Ebb Fully Upholstered Bench
 One Linking End**

	MODEL	LIST PRICE/GRADE	COM/COL	A	B	C	D	E	F	G	H	I	J	K	L
96" long	EBFUCL-96		\$3887	4273	4536	4807	5087	5374	5671	5976	6290	6614	6948	7291	7645

W 17.5 L 18.5

COM Yardage: 5.5 yards
 For COL requirements please contact Leland Customer Care.
 Unit comes with skirt.

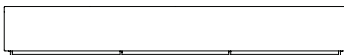

**Ebb Fully Upholstered Bench
 One Linking End**

	MODEL	LIST PRICE/GRADE	COM/COL	A	B	C	D	E	F	G	H	I	J	K	L
120" long	EBFUCL-120		\$4513	4976	5288	5609	5940	6280	6631	6992	7365	7748	8143	8549	8968

W 17.5 L 18.5

COM Yardage: 7 yards
 For COL requirements please contact Leland Customer Care.
 Unit comes with skirt.

To specify:
 Please refer to pages 3-4 for
 complete specifying information.
 Specify all products by their
 product code.

Pricing Effective: July 2021

EBB FULLY UPHOLSTERED BENCH TWO LINKING ENDS
 Design: Mark Gabbartas

EB7



**Ebb Fully Upholstered Bench
 Two Linking Ends**

	MODEL	LIST PRICE/GRADE	COM/COL	A	B	C	D	E	F	G	H	I	J	K	L
30" long	EBFULL-30		\$2042	2218	2342	2470	2602	2738	2878	3023	3171	3324	3482	3644	3812

W 17.5 L 18.5

COM Yardage: 1.75 yards
 For COL requirements please contact Leland Customer Care.
 Unit comes with skirt.

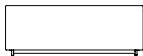

**Ebb Fully Upholstered Bench
 Two Linking Ends**

	MODEL	LIST PRICE/GRADE	COM/COL	A	B	C	D	E	F	G	H	I	J	K	L
48" long	EBFULL-48		\$2667	2913	3084	3259	3440	3626	3817	4015	4218	4428	4643	4866	5094

W 17.5 L 18.5

COM Yardage: 2.75 yards
 For COL requirements please contact Leland Customer Care.
 Unit comes with skirt.

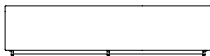

**Ebb Fully Upholstered Bench
 Two Linking Ends**

	MODEL	LIST PRICE/GRADE	COM/COL	A	B	C	D	E	F	G	H	I	J	K	L
72" long	EBFULL-72		\$3297	3602	3814	4031	4256	4487	4725	4970	5222	5482	5750	6026	6310

W 17.5 L 18.5

COM Yardage: 4.25 yards
 For COL requirements please contact Leland Customer Care.
 Unit comes with skirt.



**Ebb Fully Upholstered Bench
 Two Linking Ends**

	MODEL	LIST PRICE/GRADE	COM/COL	A	B	C	D	E	F	G	H	I	J	K	L
96" long	EBFULL-96		\$3921	4308	4572	4845	5125	5414	5711	6018	6334	6659	6994	7339	7694

W 17.5 L 18.5

COM Yardage: 5.5 yards
 For COL requirements please contact Leland Customer Care.
 Unit comes with skirt.

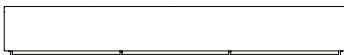

**Ebb Fully Upholstered Bench
 Two Linking Ends**

	MODEL	LIST PRICE/GRADE	COM/COL	A	B	C	D	E	F	G	H	I	J	K	L
120" long	EBFULL-120		\$4548	5013	5328	5652	5986	6331	6685	7050	7427	7814	8213	8624	9048

W 17.5 L 18.5

COM Yardage: 7 yards
 For COL requirements please contact Leland Customer Care.
 Unit comes with skirt.

To specify:
 Please refer to pages 3-4 for
 complete specifying information.
 Specify all products by their
 product code.

EBB FULLY UPHOLSTERED BENCH AUXILIARY OPTIONS

Design: Mark Gabbartas

EB8

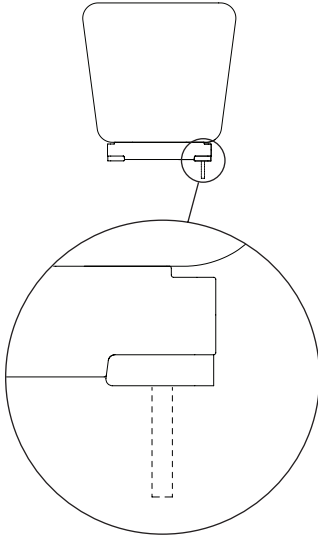

**Ebb Fully Upholstered Bench
Floor Mount**

MODEL

LIST PRICE

FM

\$219

Due to the variety of floor surfaces on which Ebb products may be installed, floor mount fasteners are not supplied by Leland International. The Ebb product floor mount option consists of feet with floor mount brackets designed to use .5" thread diameter fasteners. Responsibility of fastener choice is the customers.

Floor Mount requires a skirt and both must be specified at the time of ordering. The Floor Mount cannot be added later in the field.



**Ebb Fully Upholstered Bench
Two Closed Ends Skirt**

MODEL

LIST PRICE

Black Powdercoat Finish

SK

\$137

Ebb Fully Upholstered Bench Two Closed Ends Skirt must be specified at the time of ordering. Skirt cannot be added later in the field. Linking Ebb Benches come standard with skirts..

To specify:
Please refer to pages 3-4 for complete specifying information.
Specify all products by their product code.

Pricing Effective: July 2021

Hub Model

DESCRIPTION	CODE
Ebb Hub, upholstered, one linking end	EBH1L
Ebb Hub, upholstered, two linking ends, 240 degrees	EBH2L
Ebb Hub, upholstered, two linking ends, 180 degrees	EBH3L
Ebb Hub, upholstered, three linking ends	EBH4L

Upholstery Selection

Please refer to Leland Textile Program which features textiles and leathers from the following partners:

- Camira
- Carnegie
- CF Stinson
- Green Hides
- Maharam
- Unika Vaev

The complete grade list can be found at www.lelandfurniture.com/resources or you can specify COM/COL. All non pre-approved textiles need to be tested for compatibility.

Due to upholstery requirements, the Ebb product line can only be upholstered railroaded. Please consider when specifying textiles with a pattern. Untested COM or COL textiles will not be accepted.

Powder Coat Frame Finishes

Ebb Fully Upholstered Hubs have black powder coat skirts.

DESCRIPTION	CODE
Sterling	ST
Warm Grey	WG
Cool Grey	CG
Black	B
White	W
Matte Gold Rush	MGR
Matte Mercury	MMR
Matte Mineral	MMN
Matte Burnish	MBN
Matte Foundry	MFN
Matte New Penny	MNP
Black Textured	BT
Grey Textured	GT
White Textured	WT
Chrome	C

Auxiliary Options

Auxiliary Options must be specified at the time of the order.

DESCRIPTION	CODE
Ebb Fully Upholstered Hub Floor Mount	FM

Glides

Ebb glides are nylon.

Product Specification

Ebb layout is required at the quotation stage and order stage to ensure accurate product specifications. Contact Leland Customer Care for CAD drawings.

Specifications required to create the product code

- Model
- Model
- Upholstery Selection
- Leg Finish
- Floor Mount (when applicable)



MODEL

Ebb Fully Upholstered Hub -
One Linking End (EBH1L)

UPHOLSTERY SELECTION

Enter upholstery grade,
COM or COL. Grade J (J)

LEG FINISH

Specify Standard Powder Coat

FLOOR MOUNT

When Applicable, enter Ebb
floor mount code



EBB FULLY UPHOLSTERED HUB
Design: Mark Gabbartas

EB11

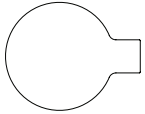

Ebb Fully Upholstered Hub	MODEL	LIST PRICE/GRADE	COM/COL	A	B	C	D	E	F	G	H	I	J	K	L
One linking end	EBH1L		\$6293	6973	7427	7895	8377	8874	9386	9912	10455	11014	11590	12183	12793

DIA 60 EXT 15

COM Yardage: 5.25 yards
For COL requirements please contact Leland Customer Care.
Unit comes with skirt.

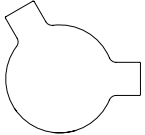

Ebb Fully Upholstered Hub	MODEL	LIST PRICE/GRADE	COM/COL	A	B	C	D	E	F	G	H	I	J	K	L
Two linking ends, 240 degrees	EBH2L		\$6628	7402	7911	8436	8976	9533	10106	10697	11305	11931	12576	13241	13926

DIA 60 EXT 15

COM Yardage: 5.75 yards
For COL requirements please contact Leland Customer Care.
Unit comes with skirt.

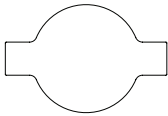

Ebb Fully Upholstered Hub	MODEL	LIST PRICE/GRADE	COM/COL	A	B	C	D	E	F	G	H	I	J	K	L
Two linking ends, 180 degrees	EBH3L		6628	7402	7911	8436	8976	9533	10106	10697	11305	11931	12576	13241	13926

DIA 60 EXT 15

COM Yardage: 7 yards
For COL requirements please contact Leland Customer Care.
Unit comes with skirt.

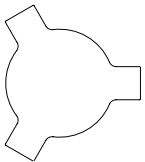

Ebb Fully Upholstered Hub	MODEL	LIST PRICE/GRADE	COM/COL	A	B	C	D	E	F	G	H	I	J	K	L
Three linking ends	EBH4L		\$6963	7826	8388	8967	9563	10177	10809	11461	12131	12822	13534	14267	15022

DIA 60 EXT 15

COM Yardage: 8 yards
For COL requirements please contact Leland Customer Care.
Unit comes with skirt.

To specify:
Please refer to pages 9-10 for complete specifying information.
Specify all products by their product code.

Pricing Effective: July 2021

EBB FULLY UPHOLSTERED HUB AUXILIARY OPTIONS

Design: Mark Gabbartas

EB12

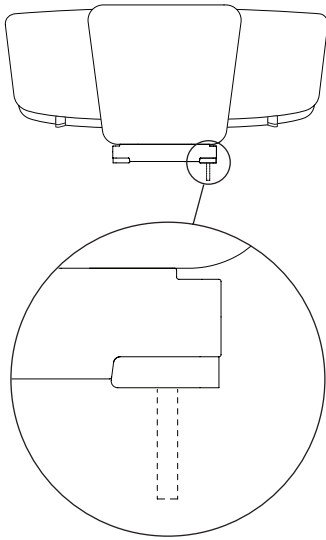

**Ebb Fully Upholstered Hub
Floor Mount**

MODEL

LIST PRICE

FM

\$219

Due to the variety of floor surfaces on which Ebb products may be installed, floor mount fasteners are not supplied by Leland International. The Ebb product floor mount option consists of feet with floor mount brackets designed to use .5" thread diameter fasteners. Responsibility of fastener choice is the customers.

Floor Mount must be specified at the time of ordering.

The Floor Mount cannot be added later in the field.

To specify:

Please refer to pages 9-10 for complete specifying information.

Specify all products by their product code.

Pricing Effective: July 2021

Pod Model

DESCRIPTION	CODE
Ebb Fully Upholstered Pod	EBH5

Upholstery Selection

Please refer to Leland Textile Program which features textiles and leathers from the following partners:

- Camira
- Green Hides
- Carnegie
- Maharam
- CF Stinson
- Unika Vaev

The complete grade list can be found at www.lelandfurniture.com/resources or you can specify COM/COL.

Due to upholstery requirements, the Ebb product line can only be upholstered railroaded. Please consider when specifying textiles with a pattern. Untested COM or COL textiles will not be accepted.

Leg Finish

DESCRIPTION	CODE
Sterling	ST
Warm Grey	WG
Cool Grey	CG
Black	B
White	W
Matte Gold Rush	MGR
Matte Mercury	MMR
Matte Mineral	MMN
Matte Burnish	MBN
Matte Foundry	MFN
Matte New Penny	MNP
Black Textured	BT
Grey Textured	GT
White Textured	WT
Chrome	C

Auxiliary Options

Auxiliary Options must be specified at the time of the order.

SKIRT:

DESCRIPTION	CODE
Ebb Fully Upholstered Pod Skirt	SK

FLOOR MAT:

DESCRIPTION	CODE
Ebb Fully Upholstered Pod Floor Mount	FM
Floor Mount requires Skirt.	

Glides

Ebb glides are nylon.

Product Specification

Ebb layout is required at the quotation stage and order stage to ensure accurate product specifications. Contact Leland Customer Experience for CAD drawings.

Specifications required to create the product code

- Model
- Upholstery Selection
- Leg Finish
- Skirt (when applicable)
- Floor Mount (when applicable)



MODEL

Ebb Fully Upholstered Pod (EBH5)

UPHOLSTERY SELECTION

Enter upholstery grade, COM or COL. Grade J (J)

LEG FINISH

Specify Standard Powder Coat

SKIRT

Skirt (SK)

FLOOR MOUNT

When applicable, enter Ebb floor mount code. Floor Mount requires Skirt.



EBB FULLY UPHOLSTERED POD
 Design: Mark Gabbartas

EB15

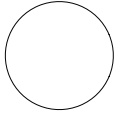

Ebb Fully Upholstered Pod	MODEL	LIST PRICE/GRADE	COM/COL	A	B	C	D	E	F	G	H	I	J	K	L
No linking end	EBH5		5820	6486	6927	7381	7849	8331	8827	9339	9865	10408	10966	11542	12134

DIA 54 SH 18.5

COM Yardage: 6 yards
 For COL requirements please contact Leland Customer Care.

To specify:
 Please refer to pages 13-14 for complete specifying information.
 Specify all products by their product code.

Pricing Effective: July 2021

EBB FULLY UPHOLSTERED POD AUXILIARY OPTIONS

Design: Mark Gabbartas

EB16

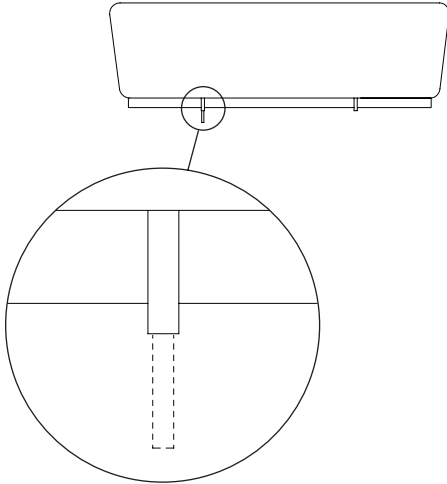

**Ebb Fully Upholstered Pod
Floor Mount**

	MODEL	LIST PRICE
	FM	\$219

Due to the variety of floor surfaces on which Ebb products may be installed, floor mount fasteners are not supplied by Leland International. The Ebb product floor mount option consists of feet with floor mount brackets designed to use .5" thread diameter fasteners. Responsibility of fastener choice is the customers.

Floor Mount requires a skirt and both must be specified at the time of ordering. The Floor Mount cannot be added later in the field.



**Ebb Fully Upholstered Pod
Skirt**

	MODEL	LIST PRICE
Black Powdercoat Finish	SK	\$137

Ebb Fully Upholstered Bench Two Closed Ends Skirt must be specified at the time of ordering. Skirt cannot be added later in the field.

To specify:
Please refer to pages 13-14 for complete specifying information. Specify all products by their product code.

Pricing Effective: July 2021

**5695 Eagle Drive, SE
Grand Rapids,
Michigan 49512
616-975-9260
lelandfurniture.com**













Fast Table

July 2021 Price List



Fast Table

Table of Contents	FT2
Visual Reference	FT3
Table Top Specification Information	FT4
Table Top Specification Example	FT5
Table Tops	FT6
Table Base Specification Information	FT7
Table Base Specification Example	FT8
Table Bases	FT9
Modesty Panel Specification Information	FT10
Modesty Panel Specification Example	FT11
Modesty Panel	FT12
Transport Trolley Specification Information	FT13
Transport Trolley Specification Example	FT14
Transport Trolley	FT15

TABLE MODEL	TABLE TOP SIZES			BASE	PAGE
Size A	Round	Sqaure	Rectangle	Powdercoat	Top: Page 6 Base: Page 9
	 48 DIA 54 DIA	 42 x 42	 24 x 48 30 x 48		
Size B	Round	Sqaure	Rectangle	Powdercoat	Top: Page 6 Base: Page 9
	 60 DIA	 48 x 48	 24 x 60 30 x 60		
Size C	Round	Sqaure	Rectangle	Powdercoat	Top: Page 6 Base: Page 9
	 72 DIA	 54 x 54	 24 x 72 30 x 72		

To specify:
Please refer to pages 3-4 for complete specifying information.
Specify all products by their product code.

Due to the design intent of Fast, table tops and table bases are sold separately. This page is for specifying the table top only.

Table Top Model

ROUND	FITS BASE	CODE
48 DIA	A	F48A
54 DIA	A	F54A
60 DIA	B	F60B
72 DIA	C	F72C
SQUARE		
42x42	A	F4242A
48x48	B	F4848B
54x54	C	F5454C
RECTANGLE		
24x48	A	F2448A
30x48	A	F3048A
24x60	B	F2460B
30x60	B	F3060B
24x72	C	F2472C
30x72	C	F3072C

Top Surface

LAMINATE TOPS:

DESCRIPTION	CODE
Identify manufacturer, laminate code, & color	L

Please refer to the Leland Terms and Conditions Guide for a listing of standard laminates. For table pricing in laminates not listed, please contact Leland's Customer Experience Department for a quotation.

Edge Type

V7 VINYL EDGE:

.75" 3mm PVC



Edge Color

V7 VINYL EDGE COLORS:

DESCRIPTION	CODE
Black	B
Grey	G
Pewter	PW
Saddle	SL
Stone	SN
Truffle	TF
White	W

Attachment Color

DESCRIPTION	CODE
Black	B

Auxiliary Options

DESCRIPTION	CODE
Ganging Device (two per set)	GD

Specifications required to create the product code

- Model
- Top Surface
- Edge Color
- Attachment Color
- Auxiliary Options (when applicable)



MODEL

Fast 30 x 60 Rectangle Table Top (F3060B)

TOP SURFACE

Laminate (L)

EDGE COLOR

Grey (G)







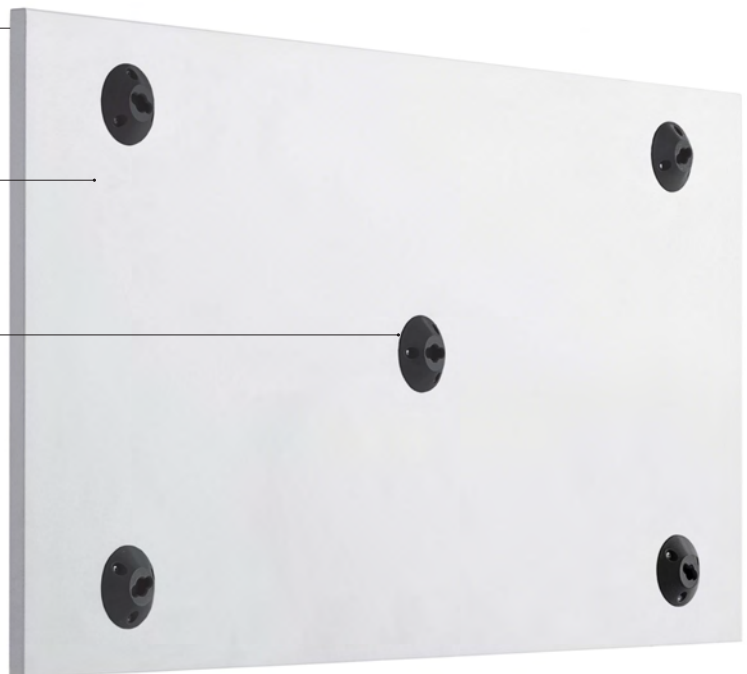

ATTACHMENT COLOR

Black (B)

AUXILIARY OPTIONS

When applicable



Fast Table Top	MODEL	FRAME FINISH	LIST PRICE
Laminate Top			
Top sizes for base A	F48A	48 DIA	\$1154
  	F54A	54 DIA	\$1176
Round	F60B	60 DIA	\$1200
48 DIA	F72C	72 DIA	\$3196
54 DIA	F4242A	42x42	\$886
	F4848B	48x48	\$912
Top sizes for base B	F5454C	54x54	\$1311
  	F2448A	24x48	\$492
Round	F3048A	30x48	\$582
60 DIA	F2460B	24x60	\$606
	F3060B	30x60	\$701
Top sizes for base C	F2472C	24x72	\$686
  	F3072C	30x72	\$820
Square			
72 DIA			

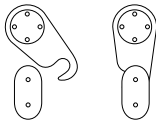

Ganging Device	MODEL	LIST PRICE
two per set	GD	\$162

To specify:
 Please refer to pages 3-4 for complete specifying information.
 Specify all products by their product code.

Due to the design intent of Fast, table tops and table bases are sold separately. This page is for specifying the table bases only.

Table Base Model

DESCRIPTION	CODE
Base A (fits 48 Dia, 54 Dia, 42x42, 24x48 and 30x48)	FBA
Base B (fits 60 Dia, 48x48, 24x60 and 30x60)	FBB
Base C (fits 72 Dia, 54x54, 24x72 and 30x72)	FBC

Base Finish

DESCRIPTION	CODE
Sterling	ST
Warm Grey	WG
Cool Grey	CG
Black	B
White	W
Matte Gold Rush	MGR
Matte Mercury	MMR
Matte Mineral	MMN
Matte Burnish	MBN
Matte Foundry	MFN
Matte New Penny	MNP

Glide and Attachment Color

DESCRIPTION	CODE
Black	B

Freight Note

Due to the size and nature of Fast Tables, the Freight Program does not apply to this product. Please contact Customer Experience for a quote.

Specifications required to create the product code

- Model
- Base Finish
- Glide and Attachment Color

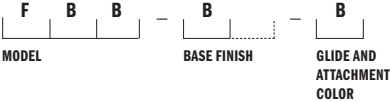

MODEL

Fast Size B Table Base (FBB)

BASE FINISH

Black (B)

GLIDE AND ATTACHMENT COLOR

Black (B)

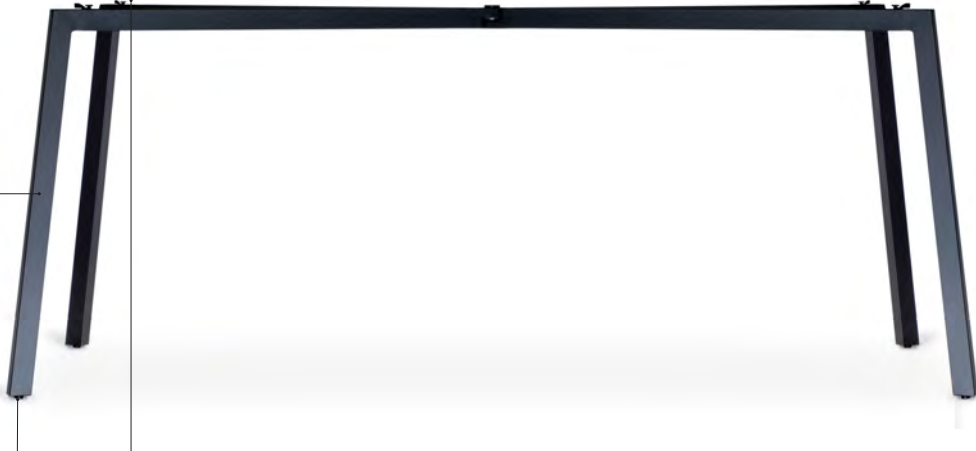

FAST TABLE BASES

Design: Carlos Tíscar, licensed by Sellex

FT9



Base Size A	MODEL	LIST PRICE
W 46.7 H 27.4	FBA	\$1108

Fits Top Sizes:



Round
48 DIA
54 DIA



Square
42 x 42



Rectangle
24 x 48
30 x 48

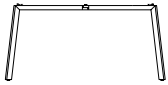

Base Size B	MODEL	LIST PRICE
W 57.8 H 27.4	FBB	\$1130

Fits Top Sizes:



Round
60 DIA



Square
48 x 48



Rectangle
24 x 60
30 x 60

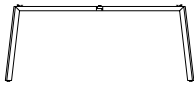

Base Size C	MODEL	LIST PRICE
W 68 H 27.4	FBC	\$1154

Fits Top Sizes:



Round
72 DIA



Square
54 x 54



Rectangle
24 x 72
30 x 72

To specify:

Please refer to table bases on pages 4-5 and table tops on pages 7-8 for complete specifying information.

Specify all products by their product code.

Pricing Effective: July 2021

Model

DESCRIPTION	FITS BASE	CODE
Modesty panel for 24x48 table	A	FM2448
Modesty panel for 30x48 table	A	FM3048
Modesty panel for 24x60 table	B	FM2460
Modesty panel for 30x60 table	B	FM3060
Modesty panel for 24x72 table	C	FM2472
Modesty panel for 30x72 table	C	FM3072

Modesty Panel Cover

DESCRIPTION	CODE
Grey	G

Optional Modesty Panel Cover (Orders of 20+ Units)

DESCRIPTION	CODE
Black	B
White	W

Specifications required to create the product code

- Model
- Modesty Panel Color

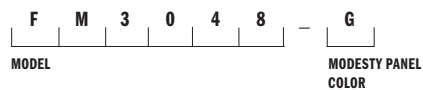

MODEL

Fast Modesty Panel for 30 x 48
Table (FM3048)

MODESTY PANEL COVER

Grey (G)





Modesty Panel	MODEL	SIZE	LIST PRICE
		Base A	
	FM2448	24x48	\$243
	FM3048	30x48	\$243
		Base B	
	FM2460	24x60	\$255
	FM3060	30x60	\$255
		Base C	
	FM2472	24x72	\$269
	FM3072	30x72	\$269

To specify:
 Please refer to table bases on pages 4-5, table tops on pages 7-8 and modesty panels on pages 10-11 for complete specifying information. Specify all products by their product code.

Model

DESCRIPTION	CODE
Fast Transport Trolley	FTT

Specifications required to create the product code

Model



MODEL

Fast Transport Trolley (FTT)



FAST TRANSPORT TROLLEY
 Design: Carlos Tíscar, licensed by Sellex

FT15

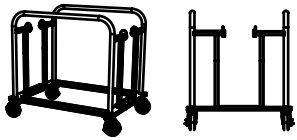

Fast Transport Trolley	MODEL	LIST PRICE
Black powder coat finish	FTT	\$2008

W 38.75 D 29.5 H 37.5

The Fast Transport Trolley can hold up to 6 table bases and 6 table tops.

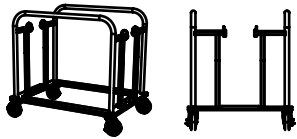

Fast Transport Trolley	MODEL	LIST PRICE
Black powder coat finish	FTT-72	\$2208

W 38.75 D 29.5 H 37.5

The Fast Transport Trolley can hold up to (6) C table bases and (4) 72 DIA table tops.

To specify:
 Please refer to page 13-14 for complete
 specifying information. Specify all products by
 their product code.

Pricing Effective: July 2021

**5695 Eagle Drive, SE
Grand Rapids,
Michigan 49512
616-975-9260
lelandfurniture.com**

Fixed Table

July 2021 Price List



Fixed Table

Table of Contents	FXT2
Visual Reference	FXT3
Specification Information	FXT4
Specification Example	FXT5
Power Planning	FXT6
Round Table	FXT7
Square Table	FXT8
Rectangular Table	FXT9
Counter Height Rectangular Tables	FXT11
Rectangular Bar Height Table	FXT13
Auxiliary Options	FXT15

TABLE MODEL	TABLE TOP SIZES	OPTIONAL POWER	PAGE
Round table	Round  42 DIA 48 DIA 54 DIA 60 DIA	1 Simplex Dual USB	6

TABLE MODEL	TABLE TOP SIZES	OPTIONAL POWER	PAGE
Square table	Square  42 x 42 48 x 48 54 x 54 60 x 60	1 Simplex Dual USB	7

TABLE MODEL	TABLE TOP SIZES	OPTIONAL POWER	PAGE
Rectangular table	Rectangle  30 x 60 36 x 72 42 x 84 30 x 72 36 x 84 42 x 96 30 x 84 36 x 96 42 x 120 36 x 120	2 Simplex units, 1 Dual USB 1 Simplex Dual USB	8

TABLE MODEL	TABLE TOP SIZES	OPTIONAL POWER	PAGE
Rectangular table Counter height	Rectangle  30 x 60 36 x 72 42 x 84 30 x 72 36 x 84 42 x 96 30 x 84 36 x 96 42 x 120 36 x 120	2 Simplex units, 1 Dual USB 1 Simplex Dual USB	9

TABLE MODEL	TABLE TOP SIZES	OPTIONAL POWER	PAGE
Rectangular table Bar height	Rectangle  30 x 60 36 x 72 42 x 84 30 x 72 36 x 84 42 x 96 30 x 84 36 x 96 42 x 120 36 x 120	2 Simplex units, 1 Dual USB 1 Simplex Dual USB	9

Table Model

DESCRIPTION	CODE
Fixed Table	FXT

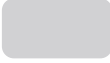
Top Selection

ROUND		SQUARE	
DESCRIPTION	CODE	DESCRIPTION	CODE
42D	42D-29	42x42	4242-29
48D	48D-29	48x48	4848-29
54D	54D-29	54x54	5454-29
60D	60D-29	60x60	6060-29

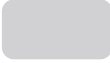
RECTANGULAR		COUNTER HEIGHT RECTANGULAR	
DESCRIPTION	CODE	DESCRIPTION	CODE
30x60	3060-29	30x60	3060-36
30x72	3072-29	30x72	3072-36
30x84	3084-29	30x84	3084-36
36x72	3672-29	36x72	3672-36
36x84	3684-29	36x84	3684-36
36x96	3696-29	36x96	3696-36
36x120	36120-29	36x120	36120-36
42x84	4284-29	42x84	4284-36
42x96	4296-29	42x96	4296-36
42x120	42120-29	42x120	42120-36

BAR HEIGHT RECTANGULAR	
DESCRIPTION	CODE
30x60	3060-42
30x72	3072-42
30x84	3084-42
36x72	3672-42
36x84	3684-42
36x96	3696-42
36x120	36120-42
42x84	4284-42
42x96	4296-42
42x120	42120-42

Top and Edge Finish

HPL (HIGH PRESSURE LAMINATE)

DESCRIPTION	CODE
Platinum Wilsonart® (D315-60)	LGP
Black Pionite® (SE101)	LBK
White Wilsonart® (D354-60)	LWH

Edge finish options: Matching ABS (V5), natural (11) plywood (W2)
 Please refer to the Leland Terms and Conditions Guide for a listing of standard laminates.
 For table pricing in laminates not listed, please contact Leland's Customer Experience Department for a quotation.

FORBO

DESCRIPTION	CODE
Pearl	4157
Mauve	4172
Pebble	4175
Smokey Blue	4179
Olive	4184

Edge finish options: natural (11) plywood (W2)

Pricing Effective: July 2021

Top and Edge Finish (cont.)

CORIAN



DESCRIPTION	CODE
Silverite	CG
Nocturne	CB
Cameo White	CW
Domino Terrazzo	CDT
Basalt Terrazzo	CBT
Pebble Terrazzo	CPT

Edge finish options: S1 Edge (CG, CB, & CW) and S2 Edge (CDT, CBT, & CPT)

Leg Finish

DESCRIPTION	CODE
White Textured Powder coat	WT
Black Textured Powder coat	BT
Grey Textured Powder coat	GT

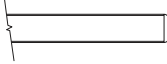
Edge Type

DESCRIPTION	CODE	DESCRIPTION	CODE
3/4" flat PVC	V5	1" flat plywood	W2
	S1	1" bullnose	S2
1" square (Solid Color Corian Tops)		1" bullnose (Terrazzo Corian Tops)	
			

Glide Type

DESCRIPTION
Standard (Black nylon adjustable leveling)

Power Options

DESCRIPTION	CODE
Single Simplex Unit (centered)	PWR
Dual USB Unit (centered)	USB
Power Kit	KIT
*(2) Single Simplex & (1) Dual USB (only available on rectangular tables)	

Auxiliary Options

DESCRIPTION	CODE
Storage Caddy	SC
*only available on rectangular tables	

Specifications required to create the product code

- Model
- Top Selection
- Top Finish
- Leg Finish
- Edge Type
- Power (if applicable)
- Auxiliary Option (if applicable)
- Glide Type



MODEL

Fixed Table (FXT)

TOP SELECTION

Counter Height Rectangular (3060-36)

TOP FINISH

Black Laminate (LBK)

LEG FINISH

Black Textured Powder coat (BT)

EDGE TYPE

1" flat plywood (W2)

POWER

When applicable enter power option (see page FXT6 for options)

AUXILIARY OPTION

Storage Caddy (SC)

GLIDE

Standard (S)



Options

Single Simplex Unit (centered, includes 120" plug-in infeed) (PWR)

Dual USB Unit (centered) (USB)

Power Kit (KIT)

*(2) Single Simplex & (1) Dual USB (only available on rectangular tables, centered)



Single Simplex Unit



Dual USB



Wire Management

Power Kit (-KIT)

*(2) Single Simplex & (1) Dual USB (only available on rectangular tables, centered)



FIXED TABLE ROUND
 Design: 2B Studio, Justin Burton

FXT7



Fixed Table Round

	MODEL	TOP SIZE/CODE	LIST PRICE/EDGE CODES:	V5	W2
Powder coat base	FXT-	Laminate Top			
H 29		42D		\$1895	2180
		48D		\$1945	2295
		54D		\$1995	2394
		60D		\$2052	2504
Round					
42 DIA					
48 DIA		Forbo Top			W2
54 DIA		42D			\$2275
60 DIA		48D			\$2335
		54D			\$2395
		60D			\$2468
		Corian Top	S1		
		42D	\$4725		
		48D	\$4894		
		54D	\$5053		
		60D	\$5200		
		Terrazzo Corian Top	S2		
		42D	\$6522		
		48D	\$7578		
		54D	\$8264		
		60D	\$8943		

To specify:
 Please refer to pages 3-4 for complete specifying information.
 Specify all products by their product code.

Pricing Effective: July 2021

FIXED TABLE SQUARE
 Design: 2B Studio, Justin Burton

FXT8

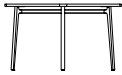

Fixed Table Square	MODEL	TOP SIZE/CODE	LIST PRICE/EDGE CODES:	V5	W2
Powder coat base	FXT-	Laminate Top			
H 29		42x42		\$1895	2180
		48x48		\$1945	2295
		54x54		\$1995	2394
	Square	60x60		\$2052	2504
42x42					
48x48		Forbo Top			W2
54x54		42x42			\$2275
60x60		48x48			\$2335
		54x54			\$2395
		60x60			\$2468
		Corian Top	S1		
		42x42	\$4725		
		48x48	\$4894		
		54x54	\$5053		
		60x60	\$5200		
		Terrazzo Corian Top	S2		
		42x42	\$6522		
		48x48	\$7578		
		54x54	\$8264		
		60x60	\$8943		

To specify:
 Please refer to pages 3-4 for complete specifying information.
 Specify all products by their product code.

Pricing Effective: July 2021

FIXED TABLE RECTANGULAR
 Design: 2B Studio, Justin Burton

FXT9



Fixed Table Rectangular	MODEL	TOP SIZE/CODE	LIST PRICE/EDGE CODES:	V5	W2
Powder coat base	FXT-	Laminate Top			
H 29		30x60		\$1995	2294
		30x72		\$2150	2473
		30x84		\$2295	2708
Rectangle		36x72		\$2460	2903
30x60		36x84		\$2695	3234
30x72		36x96		\$2854	3481
30x84		36x120		\$3248	4059
36x84		42x84		\$2969	3679
36x96		42x96		\$3084	3824
36x120		42x120		\$3314	4114
42x84					
42x96		Forbo Top			W2
42x120		30x60			\$2453
		30x72			\$2645
		30x84			\$2825
		36x72			\$3026
		36x84			\$3290
		36x96			\$3482
		36x120			\$3938
		42x84			\$3632
		42x96			\$3777
		42x120			\$4067

To specify:
 Please refer to pages 3-4 for complete specifying information.
 Specify all products by their product code.

Pricing Effective: July 2021

FIXED TABLE RECTANGULAR cont.
 Design: 2B Studio, Justin Burton

FXT10



Fixed Table Rectangular

	MODEL	TOP SIZE/CODE	LIST PRICE/EDGE CODES:
Powder coat base	FXT-	Corian Top	S1
H 29		30x60	\$4848
		30x72	\$4983
		30x84	\$5148
		36x72	\$5295
		36x84	\$5437
		36x96	\$5555
		36x120	\$5815
		42x84	\$5695
		42x96	\$5800
		42x120	\$6010
		Terrazzo Corian Top	S2
		30x60	\$6145
		30x72	\$6615
		30x84	\$7054
		36x72	\$7555
		36x84	\$8267
		36x96	\$8748
		36x120	\$9941
		42x84	\$9106
		42x96	\$9559
		42x120	\$10465

To specify:
 Please refer to pages 3-4 for complete specifying information.
 Specify all products by their product code.

Pricing Effective: July 2021

FIXED TABLE COUNTER HEIGHT RECTANGULAR
 Design: 2B Studio, Justin Burton

FXT11

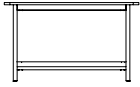

**Fixed Table Counter Height
 Rectangular**

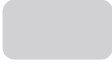
	MODEL	TOP SIZE/CODE	LIST PRICE/EDGE CODES:	V5	W2
Powder coat base	FXT-	Laminate Top			
H 36		30x60		\$3035	3490
		30x72		\$3150	3622
		30x84		\$3265	3852
	Rectangle	36x72		\$3365	3970
30x60		36x84		\$3465	4158
30x84		36x96		\$3555	4266
36x72		36x120		\$3745	4562
36x84		42x84		\$3685	4495
36x96		42x96		\$3735	4555
36x120		42x120		\$3835	4675
42x84					
42x96		Forbo Top			W2
42x120		30x60			\$3159
		30x72			\$3277
		30x84			\$3396
		36x72			\$3500
		36x84			\$3605
		36x96			\$3698
		36x120			\$3896
		42x84			\$3833
		42x96			\$3874
		42x120			\$3956

To specify:
 Please refer to pages 3-4 for complete specifying information.
 Specify all products by their product code.

Pricing Effective: July 2021

FIXED TABLE COUNTER HEIGHT RECTANGULAR cont.
 Design: 2B Studio, Justin Burton

FXT12



**Fixed Table Counter Height
 Rectangular**

	MODEL	TOP SIZE/CODE	LIST PRICE/EDGE CODES:
Powder coat base	FXT-	Corian Top	S1
H 36		30x60	\$5592
		30x72	\$5676
		30x84	\$5787
		36x72	\$5894
		36x84	\$5995
		36x96	\$6126
		36x120	\$6358
		42x84	\$6225
		42x96	\$6380
		42x120	\$6690
		Terrazzo Corian Top	S2
		30x60	\$8303
		30x72	\$8613
		30x84	\$8924
		36x72	\$9194
		36x84	\$9565
		36x96	\$9708
		36x120	\$10222
		42x84	\$10086
		42x96	\$10195
		42x120	\$10413

To specify:
 Please refer to pages 3-4 for
 complete specifying information.
 Specify all products by their
 product code.

Pricing Effective: July 2021

FIXED TABLE BAR HEIGHT RECTANGULAR
 Design: 2B Studio, Justin Burton

FXT13

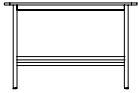

**Fixed Table Bar Height
 Rectangular**

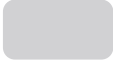
	MODEL	TOP SIZE/CODE	LIST PRICE/EDGE CODES:	V5	W2
Powder coat base	FXT-	Laminate Top			
H 42		30x60		\$3060	3519
		30x72		\$3175	3651
		30x84		\$3290	3882
	Rectangle	36x72		\$3390	3999
30x60		36x84		\$3490	4188
30x72		36x96		\$3580	4296
36x72		36x120		\$3770	4593
36x84		42x84		\$3710	4526
36x96		42x96		\$3760	4587
36x120		42x120		\$3860	4709
42x84					
42x96		Forbo Top			W2
42x120		30x60			\$3184
		30x72			\$3302
		30x84			\$3421
		36x72			\$3525
		36x84			\$3630
		36x96			\$3713
		36x120			\$3901
		42x84			\$3858
		42x96			\$3899
		42x120			\$3981

To specify:
 Please refer to pages 3-4 for
 complete specifying information.
 Specify all products by their
 product code.

Pricing Effective: July 2021

FIXED TABLE BAR HEIGHT RECTANGULAR cont.
 Design: 2B Studio, Justin Burton

FXT14



**Fixed Table Bar Height
 Rectangular**

	MODEL	TOP SIZE/CODE	LIST PRICE/EDGE CODES:
Powder coat base	FXT-	Corian Top	S1
H 42		30x60	\$5670
		30x72	\$5765
		30x84	\$5803
		36x72	\$5912
		36x84	\$6016
		36x96	\$6128
		36x120	\$6344
		42x84	\$6248
		42x96	\$6400
		42x120	\$6704
		Terrazzo Corian Top	S2
		30x60	\$8270
		30x72	\$8581
		30x84	\$8891
		36x72	\$9162
		36x84	\$9432
		36x96	\$9676
		36x120	\$10190
		42x84	\$10027
		42x96	\$10315
		42x120	\$10891

To specify:
 Please refer to pages 3-4 for complete specifying information.
 Specify all products by their product code.

Pricing Effective: July 2021

Single Simplex Unit	MODEL	LIST PRICE
	PWR	\$119

Dual USB Unit	MODEL	LIST PRICE
	USB	\$213

Power Kit	MODEL	LIST PRICE
	KIT	\$1,318

Fixed Table Storage Caddy	MODEL	LIST PRICE
	SC	\$387

To specify:
Please refer to pages 3-4 for
complete specifying information.
Specify all products by their
product code.

5695 Eagle Drive, SE
Grand Rapids,
Michigan 49512
616-975-9260
lelandfurniture.com

Fly Table

July 2021 Price List



Fly Table

Table of Contents	FLY2
Specification Information	FLY3
Specification Example	FLY4
Textured Paint	FLY5
HPL	FLY5
Wood Veneer	FLY6

Table Model

DESCRIPTION	CODE
Fly Table	FLY

Top Collection

RECTANGLE		ROUND	
DESCRIPTION	CODE	DESCRIPTION	CODE
30x60	3060	30D	30D
36x72	3672	36D	36D
42x84	4284	42D	42D
		48D	48D

LEFT HAND 'L'		OVAL	
DESCRIPTION	CODE	DESCRIPTION	CODE
40x55	4055L	30x60	30600
46x63	4663L	36x72	36720
52x72	5272L	42x84	42840
		48x96	48960

RIGHT HAND 'R'	
DESCRIPTION	CODE
40x55	4055R
46x63	4663R
52x72	5272R

VISUAL REFERENCE:



Left and right hand designations are as seated.

Top and Edge Finish

WOOD VENEER TEXTURED PAINT

DESCRIPTION	CODE	DESCRIPTION	CODE
Rift Cut Oak	O	White	WT
Walnut	W	Black	BT
		Grey	GT

Edge finish options:

Natural	11	Edge finish painted to match
Oak stain match	O	
Walnut stain match	W	

HPL (HIGH PRESSURE LAMINATE)

DESCRIPTION	CODE
Grey	Platinum Wilsonart® (D315-60)
Black	Black Pionite® (SE101)
White Designer	White Wilsonart® (D354-60)

Edge Finish Natural (11) Plywood only

Leg Selection

DESCRIPTION	CODE
Powder coat Legs	P
Polished Aluminum Legs	PA

Leg Finish (when applicable)

DESCRIPTION	CODE
White Textured Powder coat	WT
Black Textured Powder coat	BT
Grey Textured Powder coat	GT

*Please Note: Leg finish specification is required ONLY for Powder coat (P) legs

Edge Type

STANDARD EDGE:
reverse back bevel

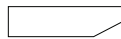

Glide Type

DESCRIPTION	CODE
Black Rubber Glide	S

Auxiliary Options

DESCRIPTION	CODE	DESCRIPTION	CODE
Power Flip Top Grommet	PT	Front Divider Screen	FD
Cable Duct	CD	Side Divider Screen	SD
Textile Cable Tray	CT	Courtesy Screen	CS
Ganging	G		

Auxiliary options are priced upon request. Please contact Customer Experience (800) 859-7510 for pricing.

Specifications required to create the product code

- Table Model
- Top Selection
- Top Finish
- Leg Selection
- Leg Finish
- Glide Selection

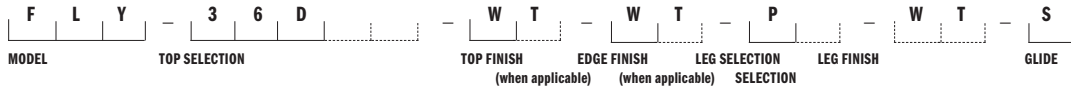

MODEL

Fly Table (FLY)

TOP SELECTION

36 Diameter Round (36D)

TOP FINISH

White Textured Paint (WT)

EDGE FINISH

White Textured Paint (WT)

LEG SELECTION

Powder coat (P)

LEG FINISH

White Textured Paint (WT)

GLIDE SELECTION

Standard Glide (S)







FLY TABLE





Design: Lievore Altherr Molina, licensed by Sellex

FLY5

Textured Paint Top

			TOP SHAPE	TOP SIZE	POWDERCOAT LEGS	POLISHED ALUMINUM LEGS
H 29.5	Top Shape		Rectangle	30x60	\$1736	1847
				36x72	\$1982	2092
				42x84	\$2273	2383
			L - Table	46x63	\$2078	2187
				52x72	\$2340	2450
			Round	30D	\$1457	1568
				36D	\$1618	\$1729
				42D	\$1724	1835
			Oval	30x60	\$1799	1909
				36x72	\$2069	2180
				48x96	\$2533	2644

HPL Top (High Pressure Laminate)

			TOP SHAPE	TOP SIZE	POWDERCOAT LEGS	POLISHED ALUMINUM LEGS
H 29.5	Top Shape		Rectangle	30x60	\$1797	1907
				36x72	\$2067	2178
				42x84	\$2386	2497
			L - Table	40x55	\$1934	2043
				46x63	\$2173	2282
				52x72	\$2460	2570
			Round	30D	\$1490	1600
				36D	\$1625	1735
				42D	\$1786	1895
			Oval	30x60	\$1799	1909
				36x72	\$2163	2273
				42x84	\$2515	2625
			48x96	\$2674	2784	

To specify:
 Please refer to pages 3-4 for complete specifying information.
 Specify all products by their product code.





Pricing Effective: July 2021

FLY TABLE

Design: Lievore Altherr Molina, licensed by Sellex

FLY6

Wood Veneer Top

		TOP SHAPE	TOP SIZE	POWDERCOAT LEGS	POLISHED ALUMINUM LEGS	
H 29.5	Top Shape		Rectangle	30x60	\$1881	1992
				36x72	\$2204	2313
				42x84	\$2585	2695
			L - Table	40x55	\$2043	2154
				46x63	\$2329	2439
				52x72	\$2673	2783
			Round	30D	\$1532	1642
				36D	\$1693	1803
				42D	\$1884	1995
				48D	\$2202	2312
			Oval	30x60	\$1959	2069
				36x72	\$2313	2422
				42x84	\$2732	2843
				48x96	\$2937	3047

To specify:

Please refer to pages 3-4 for complete specifying information.

Specify all products by their product code.

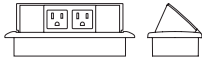

Power - Flip Top Grommet

LIST PRICE

2- 110v, 1 USB

\$962



Ganging

LIST PRICE

Link tops frontally or on the side

\$150



Textile Cable Tray

LIST PRICE

2- 110v, 1 USB

\$150

Cable Duct

LIST PRICE

2- 110v, 1 USB

\$150

To specify:
Please refer to pages 3-4 for
complete specifying information.
Specify all products by their
product code.

Pricing Effective: July 2021

FLY TABLE AUXILIARY OPTIONS
Design: Lievore Altherr Molina, licensed by Sellex

FLY8



Front Divider Panel

LIST PRICE

47.25W

\$800



Side Divider Panel

LIST PRICE

23.5W

\$500

To specify:
Please refer to pages 3-4 for
complete specifying information.
Specify all products by their
product code.

Pricing Effective: July 2021

5695 Eagle Drive, SE
Grand Rapids,
Michigan 49512
616-975-9260
lelandfurniture.com

Hammok

July 2021 Price List



Hammok

Table of Contents	HS2
Specification Information	HS3
Specification Example	HS4
Cantilever Chair	HS5
Cantilever Chair, Upholstered Onlay	HS5

Chair Model

DESCRIPTION	CODE
Hammok cantilever chair	HC
Hammok cantilever chair, upholstered onlay	HCU

Shell Finish

STANDARD LELAND COLORS

CUSTOM Specify Custom (01)

*Please note that Hammok is NOT AVAILABLE in the following finishes:
 Natural Walnut Matte (08M), Natural (11), Natural White Oak Matte (12M)

Frame Finish

DESCRIPTION	CODE
Sterling	ST
Warm Grey	WG
Cool Grey	CG
Black	B
White	W
Matte Gold Rush	MGR
Matte Mercury	MMR
Matte Mineral	MMN
Matte Burnish	MBN
Matte Foundry	MFN
Matte New Penny	MNP
Brushed Stainless Steel (Cantilever only)	BSS

Upholstered Onlay Selection

Please refer to Leland Textile Program which features textiles and leathers from the following partners:

- Camira
- Green Hides
- Carnegie
- Maharam
- CF Stinson
- Unika Vaev

The complete grade list can be found on our website or you can specify COM/COL. Due to the design of this product, it is recommended that all non pre-approved textile be tested for compatibility.

Arm Finish

Black molded ABS

Glide Type

STANDARD

DESCRIPTION	CODE
Nylon (Cantilever only)	S

Freight Note

Due to the size and nature of Hammok chairs, the Freight Program does not apply to this product. Please contact Customer Experience for a quote.

Specifications required to create the product code

- Model
- Shell Finish
- Frame Finish
- Upholstered Onlay Selection (when applicable)
- Glide Type



MODEL

Hammok Cantilever, upholstered onlay (HCU)

SHELL FINISH

Natural (11)

FRAME FINISH

Sterling (ST)

UPHOLSTERED ONLAY SELECTION

When applicable, enter upholstery grade, COM or COL.
Grade J (J)



HAMMOK CANTILEVER CHAIR
Design: Burkhard Vogtherr

HS5

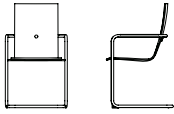

Hammok Cantilever Chair	MODEL	LIST PRICE
Powder coat frame	HC - ___	\$951
W 22 D 22 H 34.5 SH 17.75 AH 25.875		

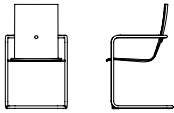

Hammok Cantilever Chair	MODEL	LIST PRICE
Brushed stainless steel frame	HC-BSS	\$1146
W 22 D 22 H 34.5 SH 17.75 AH 25.875		

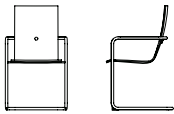

Hammok Cantilever	MODEL	LIST PRICE/ GRADE	COM/ COL	A	B	C	D	E	F	G	H	I	J	K	L
Powder coat frame, upholstered only	HCU - ___	\$1028	1090	1120	1151	1181	1212	1243	1274	1304	1335	1365	1397	1427	
COM Yardage: 1 or 2 chairs: 1.25 yards; 3 or 4 chairs: 2.5 yards Contact Leland Customer Experience for yardage requirements on textiles with repeats. For COL requirements please contact Leland Customer Experience.															
W 22 D 22 H 34.5 SH 17.75 AH 25.875															

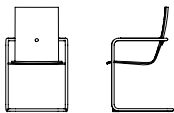

Hammok Cantilever	MODEL	LIST PRICE/ GRADE	COM/ COL	A	B	C	D	E	F	G	H	I	J	K	L
brushed stainless steel frame, upholstered only	HCU-BSS	\$1348	1410	1441	1471	1502	1532	1563	1594	1624	1655	1685	1717	1747	
COM Yardage: 1 or 2 chairs: 1.25 yards; 3 or 4 chairs: 2.5 yards Contact Leland Customer Experience for yardage requirements on textiles with repeats. For COL requirements please contact Leland Customer Experience.															
W 22 D 22 H 34.5 SH 17.75 AH 25.875															

To specify:
Please refer to pages 3-4 for complete specifying information.
Specify all products by their product code.

Pricing Effective: July 2021

**5695 Eagle Drive, SE
Grand Rapids,
Michigan 49512
616-975-9260
lelandfurniture.com**

Handy Stool

July 2021 Price List



Handy Stool

Table of contents	HA2
Specification Information	HA3
Specification Example	HA4
Handy Stool	HA5
Transport/Stacking Dolly	HA8

Model

DESCRIPTION	CODE
Handy Polypropylene	HYS-P
Handy Polypropylene Shell, Upholstered Onlay	HYS-U
Handy Polypropylene Shell, Wood Onlay	HYS-W
Handy Stool Transport Dolly, Single	HYD-S
Handy Stool Transport Dolly, Double	HYD-D

Shell Finish/Color

POLYPROPYLENE SHELL:

DESCRIPTION	CODE
White	WT
Recycled Black	RB
Grey	G
Pistachio	PS

CUSTOM POLYPROPYLENE COLORS

Custom color match is available upon request. Please contact hello@lelandfurniture.com for further information.

Upholstered Onlay Selection

Please refer to Leland Textile Program which features textiles and leathers from the following partners:

- Camira
- Green Hides
- Carnegie
- Maharam
- CF Stinson
- Unika Vaev

The complete grade list can be found on our website or you can specify COM/COL. Due to the design of this product, it is recommended that all non pre-approved textiles be tested for compatibility.

Wood Onlay Selection

DESCRIPTION	CODE
Natural Walnut	08M
Natural White Oak	12

LELAND COLORS (on maple)

Stacking Note

For Handy, ALL models stack as follows: (including upholstered and wood onlay)



Stack of 10: 44"H
Stack of 5: 29.5"H

Specifications required to create the product code

- Model
- Shell Finish
- Wood Finish Species (when applicable)
- Wood Finish Code (when applicable)
- Upholstery Option (when applicable)

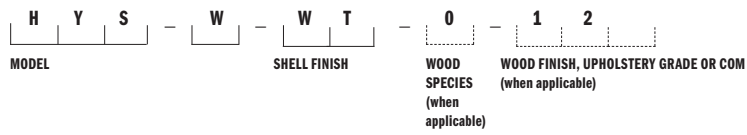

MODEL

Handy Stool (HYS)

ONLAY SELECTION

Wood (W)

SPECIES

Natural White Oak (12)

UPHOLSTERED ONLAY SELECTION

When applicable, enter upholstery grade, COM

POLYPROPYLENE SHELL FINISH

White (W)



HANDY STOOL

Design: Stephen Philips (ARUP), licensed by Sellex

HA5



PRICING FOR QUANTITIES 1-49

Handy Stool	MODEL	LIST PRICE
Polypropylene shell	HYS-P	\$229
W 16 D 14.5 H 17.5		



PRICING FOR QUANTITIES 50-99

Handy Stool	MODEL	LIST PRICE
Polypropylene shell	HYS-P	\$187
W 16 D 14.5 H 17.5		

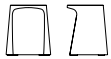

PRICING FOR QUANTITIES 100+

Handy Stool	MODEL	LIST PRICE
Polypropylene shell	HYS-P	\$167
W 16 D 14.5 H 17.5		

To specify:

Please refer to pages 3-4 for complete specifying information. Specify all products by their product code.

Pricing Effective: July 2021

HANDY STOOL

Design: Stephen Philips (ARUP), licensed by Sellex

HA6



PRICING FOR QUANTITIES 1-49

Handy Stool

polypropylene shell,
upholstered seat onlay

W 16 D 14.5 H 18.25

MODEL	LIST PRICE/GRADE	COM/COL	A	B	C	D	E	F	G	H	I	J	K	L
HYS-U		\$335	356	367	377	387	398	408	418	428	439	449	459	470

COM Yardage: 1 or 2 seats: .75 yard; 3 or 4 seats: 1.5 yards; 5 or 6 seats: 2.25 yards
Contact Leland Customer Experience for yardage requirements on textiles with repeats.
For COL requirements please contact Leland Customer Experience.



PRICING FOR QUANTITIES 50-99

Handy Stool

polypropylene shell,
upholstered seat onlay

W 16 D 14.5 H 18.25

MODEL	LIST PRICE/GRADE	COM/COL	A	B	C	D	E	F	G	H	I	J	K	L
HYS-U		\$293	314	324	334	344	354	364	374	384	394	404	414	424

COM Yardage: 1 or 2 seats: .75 yard; 3 or 4 seats: 1.5 yards; 5 or 6 seats: 2.25 yards
Contact Leland Customer Experience for yardage requirements on textiles with repeats.
For COL requirements please contact Leland Customer Experience.



PRICING FOR QUANTITIES 100+

Handy Stool

polypropylene shell,
upholstered seat onlay

W 16 D 14.5 H 18.25

MODEL	LIST PRICE/GRADE	COM/COL	A	B	C	D	E	F	G	H	I	J	K	L
HYS-U		\$273	294	304	314	324	334	344	354	364	374	384	394	404

COM Yardage: 1 or 2 seats: .75 yard; 3 or 4 seats: 1.5 yards; 5 or 6 seats: 2.25 yards
Contact Leland Customer Experience for yardage requirements on textiles with repeats.
For COL requirements please contact Leland Customer Experience.

To specify:

Please refer to pages 3-4 for complete specifying information.
Specify all products by their product code.

Pricing Effective: July 2021

HANDY STOOL

Design: Stephen Philips (ARUP), licensed by Sellex

HA7



PRICING FOR QUANTITIES 1-49

Handy Stool

MODEL

LIST PRICE

Wood onlay

HYS-W

\$361

W 16 D 14.5 H 18.5

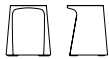

PRICING FOR QUANTITIES 50-99

Handy Stool

MODEL

LIST PRICE

Wood onlay

HYS-W

\$319

W 16 D 14.5 H 18.5



PRICING FOR QUANTITIES 100+

Handy Stool

MODEL

LIST PRICE

Wood onlay

HYS-W

\$299

W 16 D 14.5 H 18.5

To specify:

Please refer to pages 3-4 for complete specifying information. Specify all products by their product code.

Pricing Effective: July 2021

HANDY STOOL DOLLY

Design: Stephen Philips (ARUP), licensed by Sellex

HA8



Handy Stool	MODEL	LIST PRICE
Single	HYD-D	\$724
W 20.75 D 20.75 H 3.75	*Product stacks 10 high on a single dolly.	

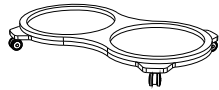

Handy Stool	MODEL	LIST PRICE
Double	HYD-D	\$1013
W 37 D 20.75 H 3.75	*Product stacks 10 high, 2 stacks on a double dolly.	

To specify:
Please refer to pages 3-4 for complete specifying information.
Specify all products by their product code.

Pricing Effective: July 2021

**5695 Eagle Drive, SE
Grand Rapids,
Michigan 49512
616-975-9260
lelandfurniture.com**

Leah Table

July 2021 Price List

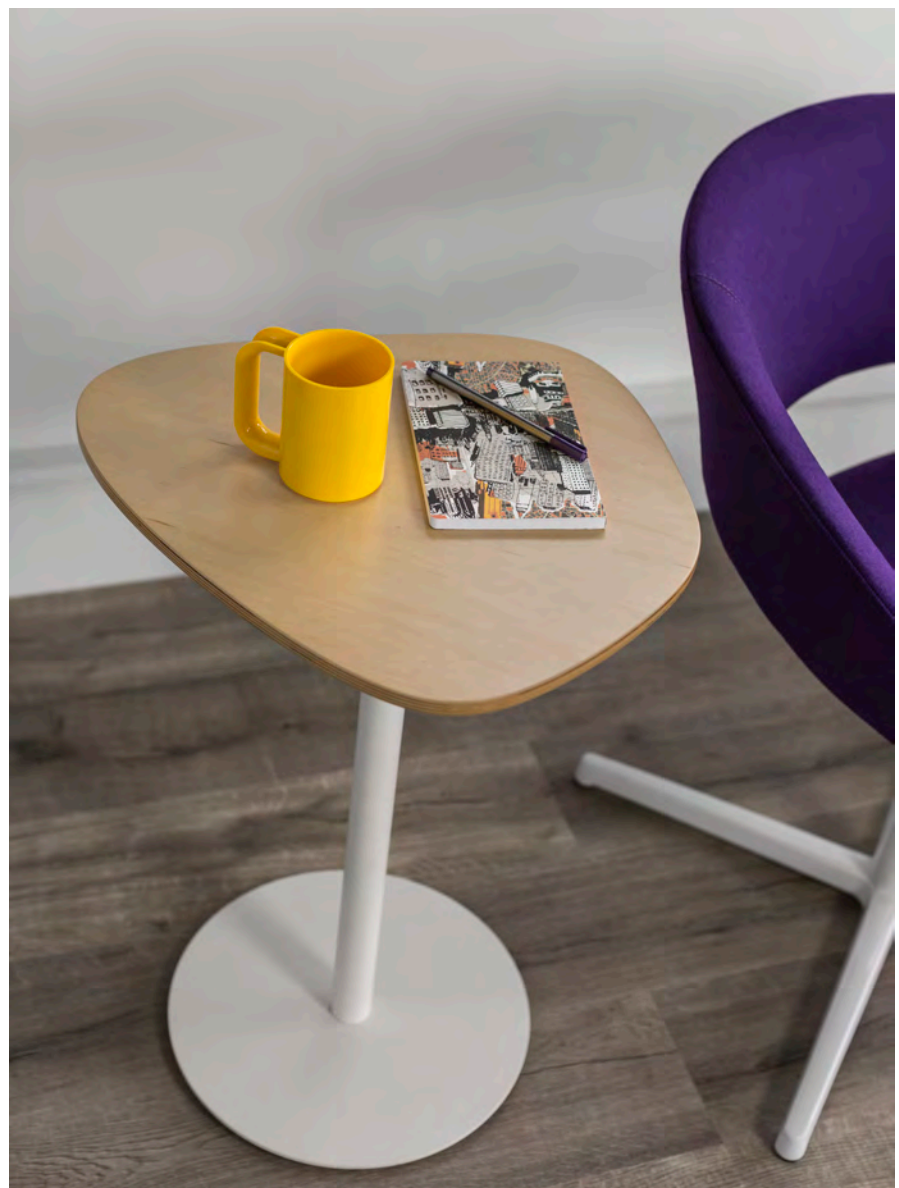

Leah Table

Table of Contents	LT2
Visual Reference	LT3
Specification Information	LT4
Specification Example	LT5
Ripple Table	LT6
Pond Table	LT7
Puddle Table	LT8
Soft Square Table	LT9
Round Table	LT10

TABLE MODEL		TABLE TOP SIZES	BASE	PAGE
Ripple (LTRP)		18x18 22x22 24x24 30x30	Powder Coat	Page LT6

TABLE MODEL		TABLE TOP SIZES	BASE	PAGE
Pond (LTPN)		22.5x15 45x30	Powder Coat	Page LT7



TABLE MODEL		TABLE TOP SIZES	BASE	PAGE
Puddle (LTPL)		22.5x15 45x30	Powder Coat	Page LT8

TABLE MODEL		TABLE TOP SIZES	BASE	PAGE
Soft Square (LTSS)		18x18 24x24 30x30	Powder Coat	Page LT9

Model

DESCRIPTION	CODE
Ripple	LTRP
Pond	LTPN
Puddle	LTPL
Soft Square	LTSS
Round	LTRD

Top Size**RIPPLE: POND/PUDDLE:**

DESCRIPTION	CODE	DESCRIPTION	CODE
18x18	1818	22.5x15	2315
22x22	2222	45x30	4530
24x24	2424		
30x30	3030		

SOFT SQUARE: ROUND:

DESCRIPTION	CODE	DESCRIPTION	CODE
18x18	1818	18D	18D
24x24	2424	24D	24D
30x30	3030	30D	30D

Top Finish**LELAND COLORS**

DESCRIPTION	CODE
Ash	A
Walnut	W

TEXTURED PAINT

DESCRIPTION	CODE
White	WT
Black	BT
Grey	GT

SOLID SURFACE

DESCRIPTION	CODE
Cameo White Corian®	CW
Silverite Corian®	CG
Nocturne Corian®	CB

BACK PAINTED GLASS

DESCRIPTION	CODE
White	WG
Black	BG
Grey	GG

LAMINATE

DESCRIPTION	CODE
Maple Laminate	LMP
Walnut Laminate	LWN
Black Laminate	LBK
White Laminate	LWH

Base Height

DESCRIPTION	CODE
14"	14H
18"	18H
22"	22H
28" (Available with 18x18 Ripple, 18x18 Soft Square, and 18D and 24D Round Tops only)	28H

Base Finish

DESCRIPTION	CODE	DESCRIPTION	CODE
White Textured	WT	Grey Textured	GT
Black Textured	BT	Sterling	ST

Glide Type

DESCRIPTION
Black HDPE Glide Plate

Edge Type

DESCRIPTION	CODE	DESCRIPTION	CODE
6mm Glass Top		1/2" Wood Top	
1/2" Laminate Top		1/2" Solid Surface Top	

Edge Options**LAMINATE EDGE FINISH**

DESCRIPTION	CODE
Natural 11	

Specifications required to create the product code

- Model
- Top Size
- Top Finish
- Edge Type
- Edge Finish
- Base Height
- Base Finish



MODEL

Ripple (LTRP)

TOP SIZE

24x24 (2424)

TOP FINISH

Silverite Corian® (CG)

EDGE TYPE

W2

EDGE FINISH

Natural (11)

BASE HEIGHT

22" Base (22H)

BASE FINISH

Grey Textured Powder coat (GT)



LEAH TABLE
Design: Bruce Sienkowski

LT6

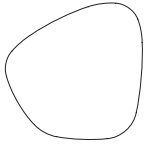

18" Ripple,

Powder Coat Base	MODEL	TOP FINISH	TEXTURED PAINT	MAPLE	ASH	WALNUT	LAMINATE	BLACK PAINTED GLASS	SOLID SURFACE
18x18" Top	LTRP-1818	14" Base	\$896	986	986	1034	1088	1218	1241
		18" Base	\$904	993	993	1042	1098	1226	1251
		22" Base	\$913	1001	1001	1050	1107	1233	1259
		28" Base	\$932	1020	1020	1067	1124	1242	1268

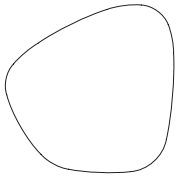

22" Ripple,

Powder Coat Base	MODEL	TOP FINISH	TEXTURED PAINT	MAPLE	ASH	WALNUT	LAMINATE	BLACK PAINTED GLASS	SOLID SURFACE
22x22" Top	LTRP-2222	14" Base	\$984	1079	1079	1139	1193	1516	1545
		18" Base	\$991	1087	1087	1148	1202	1523	1555
		22" Base	\$998	1097	1097	1156	1212	1531	1562

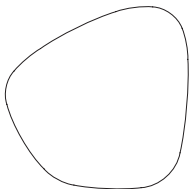

24" Ripple,

Powder Coat Base	MODEL	TOP FINISH	TEXTURED PAINT	MAPLE	ASH	WALNUT	LAMINATE	BLACK PAINTED GLASS	SOLID SURFACE
24x24" Top	LTRP-2424	14" Base	\$1065	1169	1169	1232	1249	1624	1656
		18" Base	\$1071	1177	1177	1240	1256	1632	1665
		22" Base	\$1078	1185	1185	1250	1265	1640	1674

To specify:
Please refer to pages 4-5 for complete specifying information.
Specify all products by their product code.

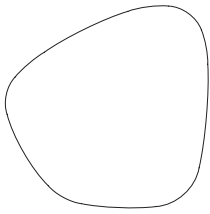

**30" Ripple,
Powder Coat Base**

	MODEL	TOP FINISH	TEXTURED PAINT	MAPLE	ASH	WALNUT	LAMINATE	BLACK PAINTED GLASS	SOLID SURFACE
30x30" Top	LTRP-3030	14" Base	\$1196	1312	1312	1391	1448	2106	2148
		18" Base	\$1203	1323	1323	1401	1455	2114	2156
		22" Base	\$1212	1331	1331	1409	1463	2121	2165

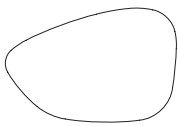

**22.5" Pond,
Powder Coat Base**

	MODEL	TOP FINISH	TEXTURED PAINT	MAPLE	ASH	WALNUT	LAMINATE	BLACK PAINTED GLASS	SOLID SURFACE
22.5x15" Top	LTPN-2315	14" Base	\$994	1092	1092	1152	1269	1582	1610
		18" Base	\$1001	1100	1100	1160	1276	1587	1617
		22" Base	\$1007	1108	1108	1169	1286	1597	1627

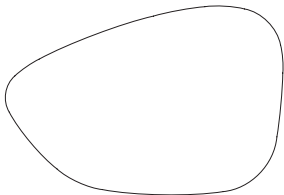

**45" Pond,
Powder Coat Base**

	MODEL	TOP FINISH	TEXTURED PAINT	MAPLE	ASH	WALNUT	LAMINATE	BLACK PAINTED GLASS	SOLID SURFACE
45x30" Top	LTPN-4530	14" Base	\$1561	1714	1714	1815	1889	2896	2953
		18" Base	\$1568	1721	1721	1824	1899	2903	2962
		22" Base	\$1574	1731	1731	1831	1907	2911	2970

To specify:
Please refer to pages 4-5 for complete specifying information.
Specify all products by their product code.

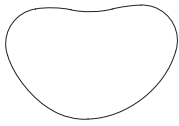

22.5" Puddle,

Powder Coat Base	MODEL	TOP FINISH	TEXTURED PAINT	MAPLE	ASH	WALNUT	LAMINATE	BLACK PAINTED GLASS	SOLID SURFACE
22.5x15" Top	LTPL-2315	14" Base	\$994	1092	1092	1152	1269	1582	1610
		18" Base	\$1001	1100	1100	1160	1276	1587	1617
		22" Base	\$1007	1108	1108	1169	1286	1597	1627

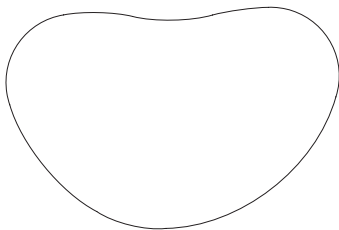

45" Puddle,

Powder Coat Base	MODEL	TOP FINISH	TEXTURED PAINT	MAPLE	ASH	WALNUT	LAMINATE	BLACK PAINTED GLASS	SOLID SURFACE
45x30" Top	LTPL-4530	14" Base	\$1561	1714	1714	1815	1889	2896	2953
		18" Base	\$1568	1721	1721	1824	1899	2903	2962
		22" Base	\$1574	1731	1731	1831	1907	2911	2970

To specify:
 Please refer to pages 4-5 for complete specifying information.
 Specify all products by their product code.

LEAH TABLE
Design: Bruce Sienkowski

LT9

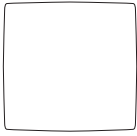

**18" Soft Square,
Powder Coat Base**

	MODEL	TOP FINISH	TEXTURED PAINT	MAPLE	ASH	WALNUT	LAMINATE	BLACK PAINTED GLASS	SOLID SURFACE
18x18" Top	LTSS-1818	14" Base	\$988	1083	1083	1137	1191	1339	1366
		18" Base	\$994	1093	1093	1147	1201	1348	1376
		22" Base	\$1003	1103	1103	1156	1212	1358	1385

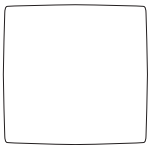

**24" Soft Square,
Powder Coat Base**

	MODEL	TOP FINISH	TEXTURED PAINT	MAPLE	ASH	WALNUT	LAMINATE	BLACK PAINTED GLASS	SOLID SURFACE
24x24" Top	LLTSS-2424	14" Base	\$1172	1286	1286	1355	1371	1787	1823
		18" Base	\$1179	1295	1295	1365	1379	1795	1830
		22" Base	\$1186	1303	1303	1374	1388	1804	1840

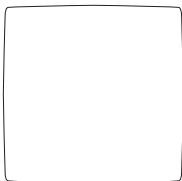

**30" Soft Square,
Powder Coat Base**

	MODEL	TOP FINISH	TEXTURED PAINT	MAPLE	ASH	WALNUT	LAMINATE	BLACK PAINTED GLASS	SOLID SURFACE
30x30" Top	LTSS-3030	14" Base	\$1315	1445	1445	1531	1586	2317	2364
		18" Base	\$1325	1454	1454	1539	1596	2326	2372
		22" Base	\$1332	1463	1463	1548	1603	2334	2381

To specify:
Please refer to pages 4-5 for complete specifying information.
Specify all products by their product code.

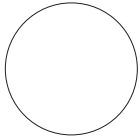

18" Round,

Powder Coat Base

	MODEL	TOP FINISH	TEXTURED PAINT	MAPLE	ASH	WALNUT	LAMINATE	BLACK PAINTED GLASS	SOLID SURFACE
18" Round Top	LTRD-18D	14" Base	\$988	1083	1083	1137	1191	1339	1366
		18" Base	\$994	1093	1093	1147	1201	1348	1376
		22" Base	\$1003	1103	1103	1156	1212	1358	1385
		28" Base	\$1019	1122	1122	1176	1230	1378	1406

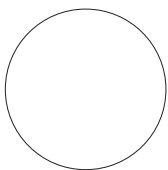

24" Round,

Powder Coat Base

	MODEL	TOP FINISH	TEXTURED PAINT	MAPLE	ASH	WALNUT	LAMINATE	BLACK PAINTED GLASS	SOLID SURFACE
24" Round Top	LTRD-24D	14" Base	\$1172	1286	1286	1355	1371	1787	1823
		18" Base	\$1179	1295	1295	1365	1379	1795	1830
		22" Base	\$1186	1303	1303	1374	1388	1804	1840
		28" Base	\$1203	1323	1323	1395	1410	1824	1861

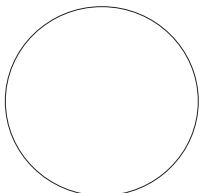

30" Round,

Powder Coat Base

	MODEL	TOP FINISH	TEXTURED PAINT	MAPLE	ASH	WALNUT	LAMINATE	BLACK PAINTED GLASS	SOLID SURFACE
30" Round Top	LTSS-30D	14" Base	\$1315	1445	1445	1531	1586	2317	2364
		18" Base	\$1325	1454	1454	1539	1596	2326	2372
		22" Base	\$1332	1463	1463	1548	1603	2334	2381

To specify:

Please refer to pages 4-5 for complete specifying information.

Specify all products by their product code.

**5695 Eagle Drive, SE
Grand Rapids,
Michigan 49512
616-975-9260
lelandfurniture.com**

M2 Seating

July 2021 Price List

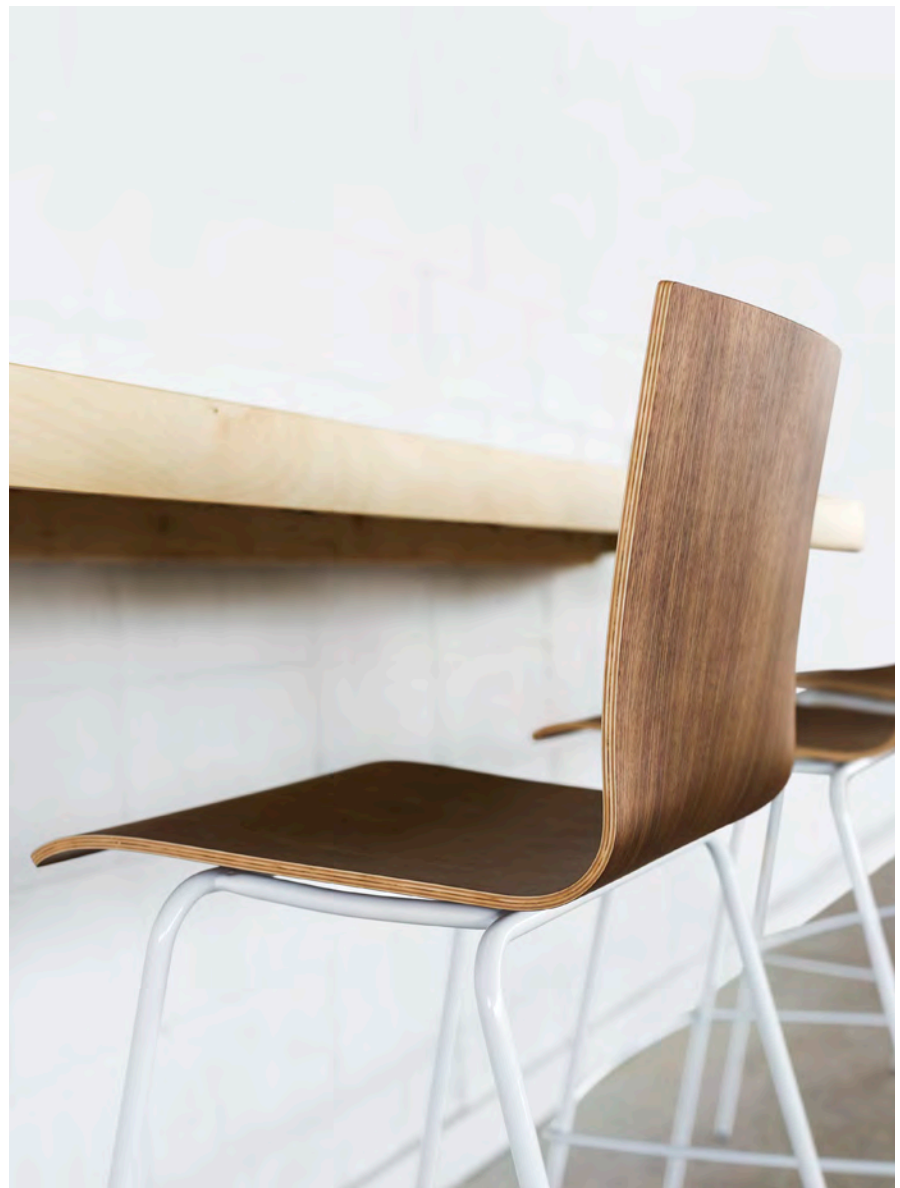

M2 Seating

Table of Contents	M2S2
Specification Information	M2S3
Specification Example	M2S4
Side Chair	M2S5
Stacking Side Chair	M2S6
Counter Chair	M2S7
Stacking Counter Chair	M2S8
Bar Chair	M2S9
Stacking Bar Chair	M2S10
Transport/Stacking Dolly	M2S11





Chair Model

DESCRIPTION	CODE
M2 side chair	M2S
M2 side chair, upholstered seat	M2SU
M2 stacking side chair	M2SS
M2 stacking side chair, upholstered seat	M2SSU
M2 counter chair	M2C
M2 counter chair, upholstered seat	M2CU
M2 stacking counter chair	M2CS
M2 stacking counter chair, upholstered seat	M2CSU
M2 bar chair	M2B
M2 bar chair, upholstered seat	M2BU
M2 stacking bar chair	M2BS
M2 stacking bar chair, upholstered seat	M2BSU

Shell Veneer

DESCRIPTION	CODE
Standard	S
Walnut	W

Shell Cut Out

DESCRIPTION	CODE	DESCRIPTION	CODE
 Plain	1	 Square	7
 Circle	2	 Soft Square	9
 Rectangle	8		

Shell Finish

STANDARD SHELL:

STANDARD LELAND COLORS

CUSTOM SPECIFY Custom (01)

*Please note that M2 Standard Shell is NOT AVAILABLE in the following finishes:
Natural Walnut Matte (08M), Natural Beech (09), Natural White Oak Matte (12M)

WALNUT SHELL:

DESCRIPTION	CODE
Natural Walnut	08

TWO-TONE SHELL:

DESCRIPTION	CODE
Black/Natural	BKC
White/Natural	WHC

Please note that the product is only available in the Natural Finishes listed above.

Frame Finish: Powder Coat and Chrome

DESCRIPTION	CODE
Sterling	ST
Warm Grey	WG
Cool Grey	CG
Black	B
White	W
Matte Gold Rush	MGR
Matte Mercury	MMR
Matte Mineral	MMN
Matte Burnish	MBN
Matte Foundry	MFN
Matte New Penny	MNP

TEXTURED C	ODE
Soda Red Textured	SRT
Dolphin Textured	DLT
Oxford Textured	OXT
Tangerine Textured	TNT
Ice Blue Textured	IBT
Artic Textured	ART
Caribbean Textured	CBT
Limelight Textured	LLT
Ink Textured	INT

Upholstered Onlay Selection

Please refer to Leland Textile Program which features textiles and leathers from the following partners:

- Camira
- Green Hides
- Carnegie
- Maharam
- CF Stinson
- Unika Vaev

The complete grade list can be found on our website or you can specify COM/COL. Due to the design of this product, it is recommended that all non pre-approved textile be tested for compatibility.

Glide Type

STANDARD:

DESCRIPTION	CODE
Nylon	S

OPTIONAL:

Please note that optional glides raise the chair height .5 inch.

DESCRIPTION	CODE
Felt	FC
Floor Saver™ (for VCT type floors)	FS
Metal	M
Rubber	R

Specifications required to create the product code

- Model
- Shell Veneer
- Cut Out
- Shell Finish
- Frame Finish
- Upholstery Selection (when applicable)
- Glide Type



MODEL

M2 Side Chair (M2S)

SHELL VENEER

Standard (S)

CUT OUT

Rectangle (8)

SHELL FINISH

Red/Natural (RDC)

FRAME FINISH

Chrome (C)

UPHOLSTERY SELECTION

When applicable, enter upholstery grade, COM or COL



M2 SIDE CHAIR
Design: Leland Design Group

M2S5



M2 Side Chair	MODEL	FRAME FINISH	LIST PRICE
Standard shell W 22 D 21.5 H 32.25 SH 17.5	M2S-S	Powder Coat	\$519
		Chrome	\$562

Optional Glides: Add \$8.00 net per chair for a set of four (4). Optional Glides raise chair height .5 inch.



M2 Side Chair	MODEL	LIST PRICE/GRADE	COM/COL	A	B	C	D	E	F	G	H	I	J	K	L
Standard Shell Upholstered seat W 22 D 21.5 H 32.25 SH 18.5	M2SU-S	Powder Coat	\$590	631	652	674	694	716	736	758	779	800	822	843	864
		Chrome	\$632	674	694	716	736	758	779	800	822	843	864	885	906

Optional Glides: Add \$8.00 net per chair for a set of four (4). Optional Glides raise chair height .5 inch.

COM Yardage: 1 to 4 Seats: 1.5 yards

Contact Leland Customer Experience for yardage requirements on textiles with repeats.

For COL requirements please contact Leland Customer Experience..



M2 Side Chair	MODEL	FRAME FINISH	LIST PRICE
Walnut shell W 22 D 21.5 H 32.25 SH 18.5	M2S-W	Powder Coat	\$590
		Chrome	\$632

Optional Glides: Add \$8.00 net per chair for a set of four (4). Optional Glides raise chair height .5 inch.



M2 Side Chair	MODEL	LIST PRICE/GRADE	COM/COL	A	B	C	D	E	F	G	H	I	J	K	L
Walnut Shell, Upholstered seat W 22 D 21.5 H 32.25 SH 18.5	M2SU-W	Powder Coat	\$661	702	723	745	765	787	809	829	851	871	893	914	935
		Chrome	\$705	746	767	788	810	830	852	872	894	915	936	958	979

Optional Glides: Add \$8.00 net per chair for a set of four (4). Optional Glides raise chair height .5 inch.

COM Yardage: 1 to 4 Seats: 1.5 yards

Contact Leland Customer Experience for yardage requirements on textiles with repeats.

For COL requirements please contact Leland Customer Experience.

To specify:

Please refer to pages 3-5 for complete specifying information.

Specify all products by their product code.

Pricing Effective: July 2021

M2 STACKING SIDE CHAIR
Design: Leland Design Group

M2S6



M2 Stacking Side Chair	MODEL	FRAME FINISH	LIST PRICE
Standard shell W 22 D 21.5 H 32.25 SH 17.5	M2SS-S	Powder Coat	\$546
		Chrome	\$590

Optional Glides: Add \$8.00 net per chair for a set of four (4). Optional Glides raise chair height .5 inch.



M2 Stacking Side Chair	MODEL	LIST PRICE/GRADE	COM/COL	A	B	C	D	E	F	G	H	I	J	K	L
Standard Shell Upholstered seat W 22 D 21.5 H 32.25 SH 18.5	M2SSU-S	Powder Coat	\$619	660	681	702	723	745	765	787	809	829	851	871	893
		Chrome	\$661	702	723	745	765	787	809	829	851	871	893	914	935

Optional Glides: Add \$8.00 net per chair for a set of four (4). Optional Glides raise chair height .5 inch.
COM Yardage: 1 to 4 Seats: 1.5 yards
Contact Leland Customer Experience for yardage requirements on textiles with repeats.
For COL requirements please contact Leland Customer Experience.



M2 Stacking Side Chair	MODEL	FRAME FINISH	LIST PRICE
Walnut shell W 22 D 21.5 H 32.25 SH 18.5	M2SS-W	Powder Coat	\$619
		Chrome	\$661

Optional Glides: Add \$8.00 net per chair for a set of four (4). Optional Glides raise chair height .5 inch.



M2 Stacking Side Chair	MODEL	LIST PRICE/GRADE	COM/COL	A	B	C	D	E	F	G	H	I	J	K	L
Walnut Shell, Upholstered seat W 22 D 21.5 H 32.25 SH 18.5	M2SSU-W	Powder Coat	\$689	730	751	773	794	815	836	857	879	899	921	941	963
		Chrome	\$733	775	796	817	838	859	881	901	923	945	965	987	1007

Optional Glides: Add \$8.00 net per chair for a set of four (4). Optional Glides raise chair height .5 inch.
COM Yardage: 1 to 4 Seats: 1.5 yards
Contact Leland Customer Experience for yardage requirements on textiles with repeats.
For COL requirements please contact Leland Customer Experience.

To specify:
Please refer to pages 3-5 for complete specifying information.
Specify all products by their product code.

Pricing Effective: July 2021

M2 COUNTER CHAIR
Design: Leland Design Group

M2S7



M2 Counter Chair	MODEL	FRAME FINISH	LIST PRICE
Standard shell	M2C-S	Powder Coat	\$770
W 21.5 D 21 H 37 SH 24.5		Chrome	\$815

Optional Glides: Add \$8.00 net per chair for a set of four (4). Optional Glides raise chair height .5 inch.



M2 Counter Chair	MODEL	LIST PRICE/GRADE	COM/COL	A	B	C	D	E	F	G	H	I	J	K	L
Standard Shell	M2CU-S	Powder Coat	\$844	885	906	927	949	969	991	1012	1033	1055	1075	1097	1118
Upholstered seat		Chrome	\$888	929	951	972	993	1015	1035	1057	1077	1099	1120	1141	1163

W 21.5 D 21 H 37 SH 25.5

Optional Glides: Add \$8.00 net per chair for a set of four (4). Optional Glides raise chair height .5 inch.

COM Yardage: 1 to 4 Seats: 1.5 yards

Contact Leland Customer Experience for yardage requirements on textiles with repeats.

For COL requirements please contact Leland Customer Experience.



M2 Counter Chair	MODEL	FRAME FINISH	LIST PRICE
Walnut shell	M2C-W	Powder Coat	\$844
W 21.5 D 21 H 37 SH 24.5		Chrome	\$888

Optional Glides: Add \$8.00 net per chair for a set of four (4). Optional Glides raise chair height .5 inch.



M2 Counter Chair	MODEL	LIST PRICE/GRADE	COM/COL	A	B	C	D	E	F	G	H	I	J	K	L
Walnut Shell,	M2CU-W	Powder Coat	\$919	960	981	1002	1023	1044	1065	1087	1108	1129	1151	1171	1193
Upholstered seat		Chrome	\$963	1004	1025	1046	1068	1089	1110	1131	1153	1173	1195	1215	1237

W 21.5 D 21 H 37 SH 25.5

Optional Glides: Add \$8.00 net per chair for a set of four (4). Optional Glides raise chair height .5 inch.

COM Yardage: 1 to 4 Seats: 1.5 yards

Contact Leland Customer Experience for yardage requirements on textiles with repeats.

For COL requirements please contact Leland Customer Experience.

To specify:

Please refer to pages 3-5 for complete specifying information.

Specify all products by their product code.

Pricing Effective: July 2021

M2 STACKING COUNTER CHAIR
Design: Leland Design Group

M2S8

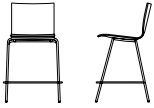

M2 Stacking Counter Chair	MODEL	FRAME FINISH	LIST PRICE
Standard shell	M2CS-S	Powder Coat	\$800
W 21.5 D 21 H 37 SH 24.5		Chrome	\$845

Optional Glides: Add \$8.00 net per chair for a set of four (4). Optional Glides raise chair height .5 inch.



M2 Stacking Counter Chair	MODEL	LIST PRICE/ GRADE	COM/COL	A	B	C	D	E	F	G	H	I	J	K	L
Standard Shell	M2CSU-S	Powder Coat	\$877	918	938	960	981	1002	1023	1044	1065	1087	1108	1129	1151
Upholstered seat		Chrome	\$919	960	981	1002	1023	1044	1065	1087	1108	1129	1151	1171	1193

W 21.5 D 21 H 37 SH 25.5

Optional Glides: Add \$8.00 net per chair for a set of four (4). Optional Glides raise chair height .5 inch.

COM Yardage: 1 to 4 Seats: 1.5 yards

Contact Leland Customer Experience for yardage requirements on textiles with repeats.

For COL requirements please contact Leland Customer Experience.



M2 Stacking Counter Chair	MODEL	FRAME FINISH	LIST PRICE
Walnut shell	M2CS-W	Powder Coat	\$877
W 21.5 D 21 H 37 SH 24.5		Chrome	\$919

Optional Glides: Add \$8.00 net per chair for a set of four (4). Optional Glides raise chair height .5 inch.



M2 Stacking Counter Chair	MODEL	LIST PRICE/ GRADE	COM/COL	A	B	C	D	E	F	G	H	I	J	K	L
Walnut Shell,	M2CSU-W	Powder Coat	\$951	992	1014	1034	1056	1076	1098	1119	1140	1161	1182	1204	1225
Upholstered seat		Chrome	\$995	1036	1058	1078	1100	1121	1142	1164	1185	1206	1227	1248	1269

W 21.5 D 21 H 37 SH 25.5

Optional Glides: Add \$8.00 net per chair for a set of four (4). Optional Glides raise chair height .5 inch.

COM Yardage: 1 to 4 Seats: 1.5 yards

Contact Leland Customer Experience for yardage requirements on textiles with repeats.

For COL requirements please contact Leland Customer Experience.

To specify:

Please refer to pages 3-5 for complete specifying information. Specify all products by their product code.

M2 BAR CHAIR
Design: Martin Ballendat

M2S9



M2 Bar Chair	MODEL	FRAME FINISH	LIST PRICE
Standard shell	M2B-S	Powder Coat	\$784
W 21.5 D 22 H 41.5 SH 29.5		Chrome	\$829

Optional Glides: Add \$8.00 net per chair for a set of four (4).



M2 Bar Chair	MODEL	LIST PRICE/GRADE	COM/COL	A	B	C	D	E	F	G	H	I	J	K	L
Standard shell, upholstered seat onlay	M2BU-S	Powder Coat	\$858	899	921	941	963	984	1005	1027	1048	1069	1090	1111	1132
		Chrome	\$905	947	967	989	1009	1031	1052	1073	1095	1115	1137	1158	1179

W 21.5 D 22 H 41.5 SH 30.5

Optional Glides: Add \$8.00 net per chair for a set of four (4). Optional Glides raise chair height .5 inch.
COM Yardage: 1 to 4 Seats: 1.5 yards
Contact Leland Customer Experience for yardage requirements on textiles with repeats.
For COL requirements please contact Leland Customer Experience.



M2 Bar Chair	MODEL	FRAME FINISH	LIST PRICE
Walnut shell	M2B-W	Powder Coat	\$858
W 21.5 D 22 H 41.5 SH 29.5		Chrome	\$905

Optional Glides: Add \$8.00 net per chair for a set of four (4). Optional Glides raise chair height .5 inch.



M2 Bar Chair	MODEL	LIST PRICE/GRADE	COM/COL	A	B	C	D	E	F	G	H	I	J	K	L
Walnut shell, upholstered seat onlay	M2BU-W	Powder Coat	\$935	976	997	1019	1040	1061	1083	1103	1125	1145	1167	1188	1209
		Chrome	\$980	1021	1042	1063	1085	1105	1127	1147	1169	1191	1211	1233	1254

W 21.5 D 22 H 41.5 SH 30.5

Optional Glides: Add \$8.00 net per chair for a set of four (4). Optional Glides raise chair height .5 inch.
COM Yardage: 1 to 4 Seats: 1.5 yards
Contact Leland Customer Experience for yardage requirements on textiles with repeats.
For COL requirements please contact Leland Customer Experience.

To specify:
Please refer to pages 3-5 for complete specifying information.
Specify all products by their product code.

M2 STACKING BAR CHAIR
Design: Martin Ballendat

M2S10



M2 Stacking Bar Chair	MODEL	FRAME FINISH	LIST PRICE
Standard shell	M2BS-S	Powder Coat	\$816
W 21.5 D 22 H 41.5 SH 29.5		Chrome	\$859

Optional Glides: Add \$8.00 net per chair for a set of four (4).



M2 Stacking Bar Chair	MODEL	LIST PRICE/GRADE	COM/ COL	A	B	C	D	E	F	G	H	I	J	K	L
Standard shell, upholstered seat onlay	M2BSU-S	Powder Coat	\$891	932	953	974	995	1017	1037	1059	1079	1101	1123	1143	1165
		Chrome	\$936	977	999	1020	1041	1062	1084	1104	1126	1146	1168	1189	1210

W 21.5 D 22 H 41.5 SH 30.5

Optional Glides: Add \$8.00 net per chair for a set of four (4). Optional Glides raise chair height .5 inch.
COM Yardage: 1 to 4 Seats: 1.5 yards
Contact Leland Customer Experience for yardage requirements on textiles with repeats.
For COL requirements please contact Leland Customer Experience.



M2 Stacking Bar Chair	MODEL	FRAME FINISH	LIST PRICE
Walnut shell	M2BS-W	Powder Coat	\$891
W 21.5 D 22 H 41.5 SH 29.5		Chrome	\$936

Optional Glides: Add \$8.00 net per chair for a set of four (4). Optional Glides raise chair height .5 inch.



M2 Stacking Bar Chair	MODEL	LIST PRICE/GRADE	COM/ COL	A	B	C	D	E	F	G	H	I	J	K	L
Walnut shell, upholstered seat onlay	M2BSU-W	Powder Coat	\$966	1007	1029	1050	1071	1092	1113	1134	1156	1177	1198	1220	1240
		Chrome	\$1010	1052	1073	1095	1115	1137	1158	1179	1200	1222	1242	1264	1284

W 21.5 D 22 H 41.5 SH 30.5

Optional Glides: Add \$8.00 net per chair for a set of four (4). Optional Glides raise chair height .5 inch.
COM Yardage: 1 to 4 Seats: 1.5 yards
Contact Leland Customer Experience for yardage requirements on textiles with repeats.
For COL requirements please contact Leland Customer Experience.

To specify:
Please refer to pages 3-5 for complete specifying information.
Specify all products by their product code.



**M2 Chair Transport/
Stacking Dolly**

	MODEL	FRAME FINISH	LIST PRICE
W 23 D 33 H 6 (empty)	M2D	Powder Coat	\$1087

To specify:
Please refer to pages 3-5 for
complete specifying information.
Specify all products by their
product code.

Pricing Effective: July 2021

5695 Eagle Drive, SE
Grand Rapids,
Michigan 49512
616-975-9260
lelandfurniture.com

M3 Table

July 2021 Price List



M3 Table

Table of Contents	M3T2
Soft Square Pedestal Table Base Visual Reference	M3T4
Soft Square Counter & Bar Base Visual Reference	M3T5
Circle Pedestal Table Base Visual Reference	M3T6
Circle Counter & Bar Table Base Visual Reference	M3T7
Specification Information	M38
Specification Example	M3T10
Small Soft Square Base	M3T11
Medium Soft Square Base	M3T12
Large Soft Square Base	M3T13
Extra Large Soft Square Base	M3T14
Small Soft Square Counter Base	M3T15
Large Soft Square CounterBase	M3T16
Small Soft Square Bar Base	M3T17
Large Soft Square Bar Base	M3T18
Extra Small Circle Base	M3T19
Small Circle Base	M3T20
Medium Circle Base	M3T21
Large Circle Base	M3T22
Extra Large Circle Base	M3T23
Extra-Extra Large Circle Base	M3T24
Extra Small Circle Counter Base	M3T25
Small Circle Counter Base	M3T26
Medium Circle Counter Base	M3T27

M3 Table

Extra Small Circle Bar Base	M3T28
Small Circle Bar Base	M3T29
Large Circle Bar Base	M3T30













TABLE MODEL	TABLE TOP SIZES			BASE	COLUMN/BASE	PAGE
Small Soft Square Pedestal Table Base	 24 DIA 30 DIA	 24 x 24 30 x 30	 24 x 30	18" Soft Square	Powder Coat/Powder Coat	Page M3T11
						
Medium Soft Square Pedestal Table Base	 36 DIA	 36 x 36		20" Soft Square	Powder Coat/Powder Coat	Page M3T12
						
Large Soft Square Pedestal Table Base	 42 DIA	 42 x 42		22" Soft Square	Powder Coat/Powder Coat	Page M3T13
						
Extra Large Soft Square Pedestal Table Base	 48 DIA	 48 x 48		24" Soft Square	Powder Coat/Powder Coat	Page M3T14
						











TABLE MODEL	TABLE TOP SIZES			BASE	COLUMN/BASE	PAGE
Small Soft Square Counter Table Base	 24 DIA 30 DIA	 24 x 24 30 x 30	 24 x 30	18" Soft Square	Powder Coat/Powder Coat	Page M3T15
Large Soft Square Counter Table Base	 36 DIA	 36 x 36		24" Soft Square	Powder Coat/Powder Coat	Page M3T16
Small Soft Square Bar Table Base	 24 DIA 30 DIA	 24 x 24 30 x 30	 24 x 30	18" Soft Square	Powder Coat/Powder Coat	Page M3T17
Large Soft Square Bar Table Base	 36 DIA	 36 x 36		24" Soft Square	Powder Coat/Powder Coat	Page M3T18















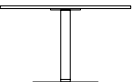

TABLE MODEL	TABLE TOP SIZES		BASE	COLUMN/BASE	PAGE
Extra Small Circle Pedestal Table Base 	Round  24 DIA	Square  24 x 24	18"-Diameter	Powder Coat/Powder Coat	Page M3T19
Small Circle Pedestal Table Base 	Round  30 DIA	Rectangle  24 x 30	20"-Diameter	Powder Coat/Powder Coat	Page M3T20
Medium Circle Pedestal Table Base 	Round  36 DIA	Square  30 x 30	22"-Diameter	Powder Coat/Powder Coat	Page M3T21
Large Circle Pedestal Table Base 	Round  42 DIA	Square  36 x 36	26"-Diameter	Powder Coat/Powder Coat	Page M3T22
Extra Large Circle Pedestal Table Base 	Round  48 DIA	Square  42 x 42	28"-Diameter	Powder Coat/Powder Coat	Page M3T23
Extra-Extra Large Circle Pedestal Table Base 		Square  48 x 48	30"-Diameter	Powder Coat/Powder Coat	Page M3T24



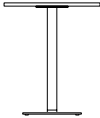



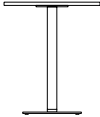

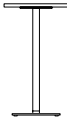

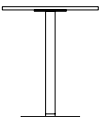



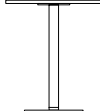

TABLE MODEL	TABLE TOP SIZES			BASE	COLUMN/BASE	PAGE
Extra Small Circle Counter Table Base 	Round  24 DIA			18"-Diameter	Powder Coat/Powder Coat	Page M3T25
Small Circle Counter Table Base 	Round  30 DIA	Square  24 x 24	Rectangle  24 x 30	20"-Diameter	Powder Coat/Powder Coat	Page M3T26
Medium Circle Counter Table Base 	Round  36 DIA	Square  30 x 30		22"-Diameter	Powder Coat/Powder Coat	Page M3T27
Extra Small Circle Bar Table Base 	Round  24 DIA			18"-Diameter	Powder Coat/Powder Coat	Page M3T28
Small Circle Bar Table Base 	Round  30 DIA	Square  24 x 24	Rectangle  24 x 30	20"-Diameter	Powder Coat/Powder Coat	Page M3T29
Medium Circle Bar Table Base 	Round  36 DIA	Square  30 x 30		22"-Diameter	Powder Coat/Powder Coat	Page M3T30

Table Model

DESCRIPTION	CODE
M3 pedestal table, small soft square base	M3SB
M3 pedestal table, medium soft square base	M3MB
M3 pedestal table, large soft square base	M3LB
M3 pedestal table, extra large soft square base	M3XLB
M3 pedestal table, small counter soft square base	M3SCB
M3 pedestal table, large counter soft square base	M3LCB
M3 pedestal table, small bar soft square base	M3SBB
M3 pedestal table, large bar soft square base	M3LBB
M3 pedestal table, extra large circle base	M3CXSB
M3 pedestal table, small circle base	M3CSB
M3 pedestal table, medium circle base	M3CMB
M3 pedestal table, large circle base	M3CLB
M3 pedestal table, extra large circle base	M3CXLB
M3 pedestal table, extra-extra large circle base	M3CXLB
M3 pedestal table, extra small counter circle base	M3CXSCB
M3 pedestal table, small bar circle base	M3CSCB
M3 pedestal table, medium bar circle base	M3CMCB
M3 pedestal table, extra small bar circle base	M3CXSB
M3 pedestal table, small bar circle base	M3CSBB
M3 pedestal table, medium bar circle base	M3CMBB

Base Finish: Powder Coat

DESCRIPTION	CODE
Black	B
White	W
Sterling	ST
Cool Grey	CG
Warm Grey	WG
Matte Gold Rush	MGR
Matte Mercury	MMR
Matte Mineral	MMN
Matte Burnish	MBN
Matte Foundry	MFN
Matte New Penny	MNP

Top Sizes

ROUND	CODE	SQUARE	CODE	RECTANGLE	CODE
24 DIA	24D	24x24	2424	24x30	2430
30 DIA	30D	30x30	3030		
36 DIA	36D	36x36	3636		
42 DIA	42D	2x42	4242		
48 DIA	48D	48x48	4848		

Top Finish or Color

WOOD TOPS:

STANDARD LELAND COLORS

CUSTOM SPECIFY custom (01)

*Please note that M3 Tables are NOT AVAILABLE in the following finishes:
Natural Walnut Matte (08M), Natural Beech (09), Natural White Oak Matte (12M)

LAMINATE TOPS:

DESCRIPTION	CODE
Grey Laminate Slate Grey Wilsonart®	LGY
Black Laminate Black Pionite®	LBK
White Laminate Designer White Wilsonart®	LWH

Please refer to the Leland Terms and Conditions Guide for a listing of standard laminates.
For table pricing in laminates not listed, please contact Leland's Customer Experience Department for a quotation.

FORBO

DESCRIPTION	CODE
Pearl	4157
Mauve	4172
Pebble	4175
Smokey Blue	4179
Olive	4184

Edge finish options: natural (11) plywood (W2)

Edge Type

VINYL EDGES:

DESCRIPTION	CODE
1 3/16" flat PVC	V2



3/4" flat PVC	V5
---------------	----



WOOD EDGES:

DESCRIPTION	CODE
1" beveled plywood	W6

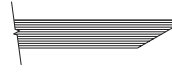

1" flat plywood	W2
-----------------	----

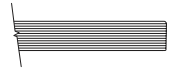

Edge Finish or Color

VINYL EDGE COLORS:

DESCRIPTION	CODE
Black	B
White	W
Grey	G

WOOD EDGE COLORS:

STANDARD LELAND COLORS

CUSTOM SPECIFY Custom (01)

*Please note that M3 Tables are NOT AVAILABLE in the following finishes:
 Natural Walnut Matte (08M), Natural Beech (09), Natural White Oak Matte (12M)

For laminate tops, edge can be specified in any standard Leland finish. Wood tops and edges must be specified in the same standard Leland finish.

Specifications required to create the product code

- Model
- Base Column Finish
- Base Plate Finish
- Top Size
- Top Finish Or Color
- Edge Type
- Edge Finish Or Color



MODEL

M3 Pedestal Table,
Medium Circle Base (M3CMB)

BASE CENTER

White (W)

TOP SIZE

42" Diameter (42D)

TOP COLOR OR FINISH

White Laminate (LWH)

EDGE TYPE

1" Flat Plywood (W2)

EDGE FINISH OR COLOR

Natural Maple (11)





M3 PEDESTAL TABLE, SMALL SOFT SQUARE BASE
 Design: Leland Design Group

M3T11



**M3 Pedestal Table,
 Powder Coat Base**

	MODEL	TOP SIZE/CODE	LIST PRICE/EDGE CODES:	V2	V5	W6	W2
Small soft square	M3SB-P-P	Wood Top					
		24 DIA - 24D		\$1279	1243	1580	1580
H 29		30 DIA - 30D		\$1670	1634	2138	2138
		24x24 - 2424		\$1279	1243	1580	1580
Round	Square	30x30 - 3030		\$1670	1634	2138	2138
		24x30 - 2430		\$1448	1412	1849	1849
24 DIA	24 x 24	Laminate Top					
30 DIA	30 x 30	24 DIA - 24D		\$1142	1106	1392	1392
		30 DIA - 30D		\$1474	1438	1867	1867
		24x24 - 2424		\$1142	1106	1391	1391
		30x30 - 3030		\$1474	1438	1867	1867
		24x30 - 2430		\$1543	1507	1879	1879
		Forbo Top					
		24 DIA - 24D				\$1657	1657
		30 DIA - 30D				\$1989	1989
		24x24 - 2424				\$1657	1657
		30x30 - 3030				\$1989	1989
		24x30 - 2430				\$2058	2058

To specify:
 Please refer to pages 6-8 for complete specifying information.
 Specify all products by their product code.

M3 PEDESTAL TABLE, MEDIUM SOFT SQUARE BASE
 Design: Leland Design Group

M3T12

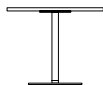

**M3 Pedestal Table,
 Powder Coat Base**

	MODEL	TOP SIZE/CODE	LIST PRICE/EDGE CODES:	V2	V5	W6	W2
Medium soft square	M3MB-P-P	Wood Top					
		36 DIA - 36D		\$1761	1725	2230	2230
H 29		36x36 - 3636		\$1761	1725	2230	2230
		Laminate Top					
Round	Square	36 DIA - 36D		\$1551	1515	1945	1945
36 DIA	36 x 36	36x36 - 3636		\$1551	1515	1945	1945
		Forbo Top					
		36 DIA - 36D				\$2066	2066
		36x36 - 3636				\$2066	2066

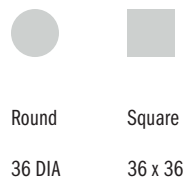

To specify:
 Please refer to pages 6-8 for complete specifying information.
 Specify all products by their product code.



Pricing Effective: July 2021

M3 PEDESTAL TABLE, LARGE SOFT SQUARE BASE
 Design: Leland Design Group

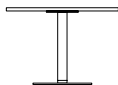
M3T13



**M3 Pedestal Table,
 Powder Coat Base**

	MODEL	TOP SIZE/CODE	LIST PRICE/EDGE CODES:	V2	W6	W2
Large soft square	M3LB-P-P	Wood Top				
		42 DIA - 42D		\$2412	2881	2881
H 29		42x42 - 4242		\$2412	2881	2881
 		Laminate Top				
Round	Square	42 DIA - 42D		\$2105	2498	2498
42 DIA	42 x 42	42x42 - 4242		\$2105	2498	2498
		Forbo Top				
		42 DIA - 42D			\$2878	2878
		42x42 - 4242			\$2878	2878

To specify:
 Please refer to pages 6-8 for complete specifying information.
 Specify all products by their product code.



Pricing Effective: July 2021

M3 PEDESTAL TABLE, EXTRA LARGE SOFT SQUARE BASE
 Design: Leland Design Group

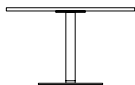
M3T14



**M3 Pedestal Table,
 Powder Coat Base**

	MODEL	TOP SIZE/CODE	LIST PRICE/EDGE CODES:	V2	W6	W2
Extra Large soft square	M3XLB-P-P	Wood Top				
		48 DIA - 48D		\$2510	2932	2881
H 29		48x48 - 4848		\$2464	2932	2881
 		Laminate Top				
Round	Square	48 DIA - 48D		\$2147	2539	2539
48 DIA	48 x 48	48x48 - 4848		\$2147	2539	2539
		Forbo Top				
		48 DIA - 48D			\$3311	3311
		48x48 - 4848			\$3311	3311

To specify:
 Please refer to pages 6-8 for complete specifying information.
 Specify all products by their product code.



Pricing Effective: July 2021

M3 PEDESTAL TABLE, SMALL SOFT SQUARE COUNTER BASE
 Design: Leland Design Group

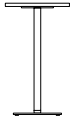
M3T15



**M3 Pedestal Table,
 Powder Coat Base**

	MODEL	TOP SIZE/CODE	LIST PRICE/EDGE CODES:	V2	V5	W6	W2
Small soft square counter	M3SCB-P-P	Wood Top					
		24 DIA - 24D		\$1338	1302	1639	1639
H 36		30 DIA - 30D		\$1728	1692	2197	2197
		24x24 - 2424		\$1338	1302	1639	1639
Round	Square	30x30 - 3030		\$1728	1692	2197	2197
		24x30 - 2430		\$1512	1471	1908	1908
24 DIA	24 x 24	Laminate Top					
30 DIA	30 x 30	24 DIA - 24D		\$1206	1170	1455	1455
		30 DIA - 30D		\$1538	1502	1931	1931
		24x24 - 2424		\$1206	1170	1455	1455
		30x30 - 3030		\$1538	1502	1931	1931
		24x30 - 2430		\$1607	1566	1943	1943
		Forbo Top					
		24 DIA - 24D				\$1752	1752
		30 DIA - 30D				\$2084	2084
		24x24 - 2424				\$1752	1752
		30x30 - 3030				\$2084	2084
		24x30 - 2430				\$2162	2162



To specify:
 Please refer to pages 6-8 for complete specifying information.
 Specify all products by their product code.

M3 PEDESTAL TABLE, LARGE SOFT SQUARE COUNTER BASE
 Design: Leland Design Group

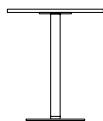
M3T16



**M3 Pedestal Table,
 Powder Coat Base**

	MODEL	TOP SIZE/CODE	LIST PRICE/EDGE CODES:	V2	V5	W6	W2
Large soft square counter	M3LCB-P-P	Wood Top					
		36 DIA - 36D		\$1815	1784	2289	2289
H 36		36x36 - 3636		\$1815	1784	2289	2289
 		Laminate Top					
Round	Square	36 DIA - 36D		\$1615	1579	2009	2009
36 DIA	36 x 36	36x36 - 3636		\$1615	1579	2009	2009
		Forbo Top					
		36 DIA - 36D				2161	2161
		36x36 - 3636				2161	2161

To specify:
 Please refer to pages 6-8 for complete specifying information.
 Specify all products by their product code.



Pricing Effective: July 2021

M3 PEDESTAL TABLE, SMALL SOFT SQUARE BAR BASE
 Design: Leland Design Group

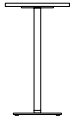
M3T17



**M3 Pedestal Table,
 Powder Coat Base**

	MODEL	TOP SIZE/CODE	LIST PRICE/EDGE CODES:	V2	V5	W6	W2
Small soft square bar	M3SBB-P-P	Wood Top					
		24 DIA - 24D		\$1395	1359	1695	1695
H 42		30 DIA - 30D		\$1785	1749	2254	2254
		24x24 - 2424		\$1395	1359	1695	1695
Round	Square	30x30 - 3030		\$1785	1749	2254	2254
		24x30 - 2430		\$1564	1527	1964	1964
24 DIA	24 x 24						
30 DIA	30 x 30						
		Laminate Top					
		24 DIA - 24D		\$1258	1222	1507	1507
		30 DIA - 30D		\$1589	1553	1983	1983
		24x24 - 2424		\$1258	1222	1507	1507
		30x30 - 3030		\$1589	1553	1983	1983
		24x30 - 2430		\$1658	1622	1994	1994
		Forbo Top					
		24 DIA - 24D				\$1773	1773
		30 DIA - 30D				\$2104	2104
		24x24 - 2424				\$1773	1773
		30x30 - 3030				\$2104	2104
		24x30 - 2430				\$2183	2183

To specify:
 Please refer to pages 6-8 for complete specifying information.
 Specify all products by their product code.

M3 PEDESTAL TABLE, LARGE SOFT SQUARE BAR BASE
 Design: Leland Design Group

M3T18

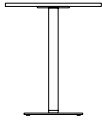

**M3 Pedestal Table,
 Powder Coat Base**

	MODEL	TOP SIZE/CODE	LIST PRICE/EDGE CODES:	V2	V5	W6	W2
Large soft square bar	M3LBB-P-P	Wood Top					
		36 DIA - 36D		\$1877	1841	2345	2345
H 42		36x36 - 3636		\$1877	1841	2345	2345
		Laminate Top					
Round	Square	36 DIA - 36D		\$1667	1630	2060	2060
36 DIA	36 x 36	36x36 - 3636		\$1667	1630	2060	2060
		Forbo Top					
		36 DIA - 36D				\$2182	2182
		36x36 - 3636				\$2182	2182

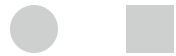

Round Square
 36 DIA 36 x 36

To specify:
 Please refer to pages 6-8 for complete specifying information.
 Specify all products by their product code.



Pricing Effective: July 2021

M3 PEDESTAL TABLE, EXTRA SMALL CIRCLE BASE
 Design: Leland Design Group

M3T19



**M3 Pedestal Table,
 Powder Coat Base**

	MODEL	TOP SIZE/CODE	LIST PRICE/EDGE CODES:	V2	V5	W6	W2
Extra small circle	M3CXSB-P-P	Wood Top					
		24 DIA - 24D		\$1279	1243	1580	1580
H 29		24x24 - 2424		\$1279	1243	1580	1580
		Laminate Top					
Round	Square	24 DIA - 24D		\$1142	1106	1392	1392
24 DIA	24 x 24	24x24 - 2424		\$1142	1106	1392	1392
		Forbo Top					
		24 DIA - 24D				\$1657	1657
		24x24 - 2424				\$1657	1657

To specify:
 Please refer to pages 6-8 for complete specifying information.
 Specify all products by their product code.

Pricing Effective: July 2021

M3 PEDESTAL TABLE, SMALL CIRCLE BASE
 Design: Leland Design Group

M3T20



**M3 Pedestal Table,
 Powder Coat Base**

	MODEL	TOP SIZE/CODE	LIST PRICE/EDGE CODES:	V2	V5	W6	W2
Small circle	M3CSB-P-P	Wood Top					
		30 DIA - 30D		\$1670	1634	2138	2138
H 29		24x30 - 2430		\$1448	1412	1849	1849
		Laminate Top					
Round		30 DIA - 30D		\$1474	1438	1867	1867
30 DIA		24x30 - 2430		\$1543	1507	1879	1879
		Forbo Top					
		30 DIA - 30D				\$1989	1989
		24x30 - 2430				\$2058	2058

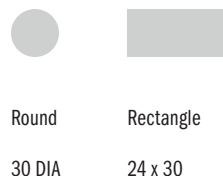

To specify:
 Please refer to pages 6-8 for complete specifying information.
 Specify all products by their product code.

M3 PEDESTAL TABLE, MEDIUM CIRCLE BASE
 Design: Leland Design Group

M3T21



**M3 Pedestal Table,
 Powder Coat Base**

	MODEL	TOP SIZE/CODE	LIST PRICE/EDGE CODES:	V2	V5	W6	W2
Medium circle	M3CMB-P-P	Wood Top					
		36 DIA - 36D		\$1761	1725	2230	2230
H 29		30x30 - 3030		\$1670	1634	2138	2138
		Laminate Top					
Round		36 DIA - 36D		\$1551	1515	1945	1945
36 DIA		30x30 - 3030		\$1474	1438	1867	1867
Square		30x30 - 3030					
		Forbo Top					
		36 DIA - 36D				\$2066	2066
		30x30 - 3030				\$1989	1989



Round Square
 36 DIA 30 x 30

To specify:
 Please refer to pages 6-8 for complete specifying information.
 Specify all products by their product code.

Pricing Effective: July 2021

M3 PEDESTAL TABLE, LARGE CIRCLE BASE
 Design: Leland Design Group

M3T22



**M3 Pedestal Table,
 Powder Coat Base**

	MODEL	TOP SIZE/CODE	LIST PRICE/EDGE CODES:	V2	V5	W6	W2
Large circle	M3CLB-P-P	Wood Top					
		42 DIA - 42D		\$2412	2376	2881	2881
H 29		36x36 - 3636		\$1761	1725	2230	2230
		Laminate Top					
Round		42 DIA - 42D		\$2105	2069	2498	2498
42 DIA		36x36 - 3636		\$1551	1515	1945	1945
Square		36x36 - 3636					
		Forbo Top					
		42 DIA - 42D				\$2878	2878
		36x36 - 3636				\$2066	2066

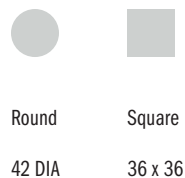

To specify:
 Please refer to pages 6-8 for complete specifying information.
 Specify all products by their product code.

Pricing Effective: July 2021

M3 PEDESTAL TABLE, EXTRA LARGE CIRCLE BASE
 Design: Leland Design Group

M3T23

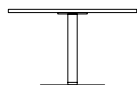

**M3 Pedestal Table,
 Powder Coat Base**

	MODEL	TOP SIZE/CODE	LIST PRICE/EDGE CODES:	V2	V5	W6	W2
Extra large circle	M3CXLB-P-P	Wood Top					
		48 DIA - 48D		\$2510	2474	2932	2881
H 29		42x42 - 4242		\$2412	2376	2881	2881
		Laminate Top					
Round		48 DIA - 48D		\$2147	2110	2539	2539
48 DIA		42x42 - 4242		\$2105	2069	2498	2498
Square		Forbo Top					
		48 DIA - 48D				\$2919	2919
		42x42 - 4242				\$2878	2878

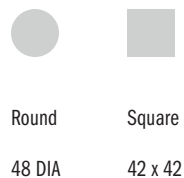

To specify:
 Please refer to pages 6-8 for complete specifying information.
 Specify all products by their product code.

Pricing Effective: July 2021

M3 PEDESTAL TABLE, EXTRA-EXTRA LARGE CIRCLE BASE
 Design: Leland Design Group

M3T24

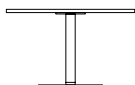

**M3 Pedestal Table,
 Powder Coat Base**

	MODEL	TOP SIZE/CODE	LIST PRICE/EDGE CODES:	V2	V5	W6	W2
Extra-extra large circle	M3CXXLB-P-P	Wood Top					
		48x48 - 4848		\$2464	2428	2932	2881
H 29		Laminate Top					
		48x48 - 4848		\$2147	2110	2539	2539
Square		Forbo Top					
		48x48 - 4848				\$2919	\$2919

To specify:
 Please refer to pages 6-8 for complete specifying information.
 Specify all products by their product code.

Pricing Effective: July 2021

M3 PEDESTAL TABLE, EXTRA SMALL CIRCLE
COUNTER BASE

Design: Leland Design Group

M3T25



M3 Pedestal Table,

Powder Coat Base

	MODEL	TOP SIZE/CODE	LIST PRICE/EDGE CODES:	V2	V5	W6	W2
Extra small circle counter	M3CXSCB-P-P	Wood Top					
		24 DIA - 24D		\$1338	1302	1639	1639
H 36		Laminate Top					
		24 DIA - 24D		\$1206	1170	1455	1455
Circle		Forbo Top					
24 DIA		24 DIA - 24D				\$1752	1752

To specify:

Please refer to pages 6-8 for complete specifying information.

Specify all products by their product code.



Pricing Effective: July 2021

M3 PEDESTAL TABLE, SMALL CIRCLE COUNTER BASE
 Design: Leland Design Group

M3T26



**M3 Pedestal Table,
 Powder Coat Base**

	MODEL	TOP SIZE/CODE	LIST PRICE/EDGE CODES:	V2	V5	W6	W2
Small circle counter	M3CSCB-P-P	Wood Top					
		30 DIA - 30D		\$1728	1692	2197	2197
H 36		24x24 - 2424		\$1338	1302	1639	1639
		24x30 - 2430		\$1512	1471	1908	1908
  		Laminate Top					
Round		30 DIA - 30D		\$1538	1502	1931	1931
30 DIA		24x24 - 2424		\$1206	1170	1455	1455
Square		24x30 - 2430		\$1607	1566	1943	1943
24 x 24		Forbo Top					
Rectangle		30 DIA - 30D				\$2084	2084
24 x 30		24x24 - 2424				\$1752	1752
		24x30 - 2430				\$2162	2162

To specify:
 Please refer to pages 6-8 for complete specifying information.
 Specify all products by their product code.

M3 PEDESTAL TABLE, MEDIUM CIRCLE COUNTER BASE
 Design: Leland Design Group

M3T27

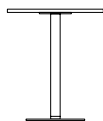

**M3 Pedestal Table,
 Powder Coat Base**

	MODEL	TOP SIZE/CODE	LIST PRICE/EDGE CODES:	V2	V5	W6	W2
Medium circle counter	M3CMCB-P-P	Wood Top					
		30X30 - 3030		\$1728	1692	2197	2197
H 36		Laminate Top					
		30X30 - 3030		\$1538	1502	1931	1931
Square		Forbo Top					
30 x 30		30X30 - 3030				\$2084	2084

To specify:
 Please refer to pages 6-8 for complete specifying information.
 Specify all products by their product code.

Pricing Effective: July 2021

M3 PEDESTAL TABLE, EXTRA SMALL CIRCLE BAR BASE
 Design: Leland Design Group

M3T28

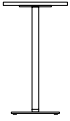

**M3 Pedestal Table,
 Powder Coat Base**

	MODEL	TOP SIZE/CODE	LIST PRICE/EDGE CODES:	V2	V5	W6	W2
Extra small circle bar	M3CXSBP-P-P	Wood Top					
		24 DIA - 24D		\$1395	1359	1695	1695
H 42		Laminate Top					
		24 DIA - 24D		\$1258	1222	1507	1507
Circle		Forbo Top					
24 DIA		24 DIA - 24D				\$1773	1773

To specify:
 Please refer to pages 6-8 for complete specifying information.
 Specify all products by their product code.



Pricing Effective: July 2021

M3 PEDESTAL TABLE, SMALL CIRCLE BAR BASE
 Design: Leland Design Group

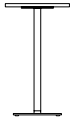
M3T29



**M3 Pedestal Table,
 Powder Coat Base**

	MODEL	TOP SIZE/CODE	LIST PRICE/EDGE CODES:	V2	V5	W6	W2
Small circle bar	M3CSBB-P-P	Wood Top					
		30 DIA - 30D		\$1785	1749	2254	2254
H 42		24x24 - 2424		\$1395	1359	1695	1695
		24x30 - 2430		\$1564	1527	1964	1964
  		Laminate Top					
Round		30 DIA - 30D		\$1589	1553	1983	1983
Square		24x24 - 2424		\$1258	1222	1507	1507
Rectangle		24x30 - 2430		\$1658	1622	1994	1994
30 DIA		Forbo Top					
		30 DIA - 30D				\$2104	2104
		24x24 - 2424				\$1773	1773
		24x30 - 2430				\$2183	2183

To specify:
 Please refer to pages 6-8 for complete specifying information.
 Specify all products by their product code.

M3 PEDESTAL TABLE, MEDIUM CIRCLE BAR BASE
 Design: Leland Design Group

M3T30

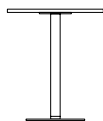

**M3 Pedestal Table,
 Powder Coat Base**

	MODEL	TOP SIZE/CODE	LIST PRICE/EDGE CODES:	V2	V5	W6	W2
Medium circle bar	M3CMBB-P-P	Wood Top					
		30X30 - 3030		\$1785	1749	2254	2254
H 42		Laminate Top					
		30X30 - 3030		\$1589	1553	1983	1983
Square		Forbo Top					
30 x 30		30X30 - 3030				\$2104	2104

To specify:
 Please refer to pages 6-8 for complete specifying information.
 Specify all products by their product code.

5695 Eagle Drive, SE
Grand Rapids,
Michigan 49512
616-975-9260
lelandfurniture.com

Marquette Seating

July 2021 Price List



Marquette Seating

Table of Contents	MQ2
Specification Information	MQ3
Specification Example	MQ4
Stacking Side Chair, Sled Base	MQ5
Stacking Side Chair, Four-Leg Base	MQ6
Arm Chair, Sled Base	MQ7
Counter Chair, Sled Base	MQ8
Counter Chair, Four-Leg Base	MQ9
Stacking Counter Chair, Four-Leg Base	MQ10
Bar Chair, Sled Base	MQ11
Bar Chair, Four-Leg Base	MQ12
Stacking Bar Chair, Four-Leg Base	MQ13
Little Marquette Side Chair	MQ14
Marquette Transport/Stacking Dolly	MQ15

Chair Model

SLED BASE:

DESCRIPTION	CODE
Marquette side chair	MQS
Marquette side chair, upholstered seat	MQSU
Marquette counter chair	MQC
Marquette counter chair, upholstered seat	MQCU
Marquette bar chair	MQB
Marquette bar chair, upholstered seat	MQBU
Little Marquette chair	MQL

4-LEG BASE:















DESCRIPTION	CODE
Marquette side chair	MQS4
Marquette side chair, upholstered seat	MQS4U
Marquette counter chair	MQC4
Marquette counter chair, upholstered seat	MQC4U
Marquette stacking counter chair	MQCS4
Marquette stacking counter chair, upholstered seat	MQCS4U
Marquette bar chair	MQB4
Marquette bar chair, upholstered seat	MQB4U
Marquette stacking bar chair	MQBS4
Marquette stacking bar chair, upholstered seat	MQBS4U

Shell Style

SHELL	CODE	SHELL	CODE
Linear	L	Arc	A



Back Cut Out

LINEAR CUT OUTS	CODE	ARC CUT OUTS	CODE
Plain back	1	Plain back	1
Circle 	2	Circle 	2
Diamond 	4	Diamond 	4
Grid 	5	Grid 	5
Perforated 	3	Slotted 	6
Dots 	10	Dots 	10
Squares 	11	Reeds 	13
Reeds 	13	Mosaic 	15
Custom cut out	00	Custom cut out	00

Shell and Arm Cap Finish

STANDARD LELAND COLORS

CUSTOM SPECIFY Custom (01)

*Please note that Marquette Chair is NOT AVAILABLE in the following finishes:
Natural Walnut Matte (08M), Natural Beech (09), Natural White Oak Matte (12M)

Frame Finish

DESCRIPTION	CODE
Black	B
Chrome	C
Sterling	ST

TEXTURED	CODE
Soda Red Textured	SRT
Dolphin Textured	DLT
Oxford Textured	OXT
Tangerine Textured	TNT
Ice Blue Textured	IBT
Artic Textured	ART
Caribbean Textured	CBT
Limelight Textured	LLT
Ink Textured	INT

Upholstery Selection

Please refer to Leland Textile Program which features textiles and leathers from the following partners:

- Camira
- Green Hides
- Carnegie
- Maharam
- CF Stinson
- Unika Vaev

The complete grade list can be found on our website or you can specify COM/COL. Due to the design of this product, it is recommended that all non pre-approved textile be tested for compatibility.

Glide Type

STANDARD:

DESCRIPTION	CODE
Poly (Sled base)	S
Nylon (4-Leg base)	S

OPTIONAL:

DESCRIPTION	CODE
Felt	FC
Floor Saver™ (for VCT type floors) (4-Leg base only)	FS
Metal (4-Leg base only)	M
Rubber (4-Leg base only)	R

Please note that optional glides for 4-leg models raise the chair height .5 inch

Specifications required to create the product code

- Model
- Shell Style
- Back Cut Out
- Shell Finish
- Frame Finish
- Upholstery selection (when applicable)
- Arm Cap Finish (when applicable)
- Glide Type

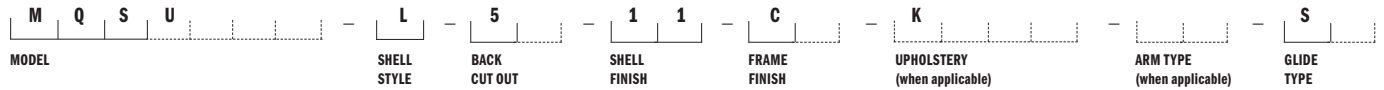

MODEL

Marquette Side Chair,
Upholstered Seat, Sled Base (MQSU)

SHELL STYLE

Linear (L)

BACK CUT OUT

Grid (5)

SHELL FINISH

Natural (11)

FRAME FINISH

Chrome (C)

UPHOLSTERY

When applicable:
Upholstery— Enter Leland textile code or COM/COL

ARM CAP FINISH

When applicable, enter
Leland Color code

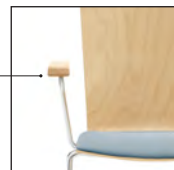

MARQUETTE STACKING SIDE CHAIR, SLED BASE
Design: Leland Design Group

MQ5

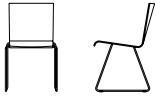

Marquette Side Chair	MODEL	FRAME FINISH	LIST PRICE
Sled base, linear shell	MQS-L	Powder Coat	\$426
W 19.75 D 21 H 34 SH 18.5		Chrome	\$475

Optional Glides: Add \$8.00 net per chair for a set of four (4).

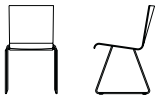

Marquette Side Chair	MODEL	LIST PRICE/GRADE	COM/COL	A	B	C	D	E	F	G	H	I	J	K	L
Sled base, linear shell upholstered seat onlay	MQSU-L	Powder Coat	\$508	530	542	553	564	576	586	597	609	620	631	642	653
		Chrome	\$557	581	592	604	614	625	637	648	659	670	681	692	703

W 19.75 D 21 H 34 SH 18.75

COM Yardage: 1, 2 or 3 seats: .75 yard; 4, 5 or 6 seats: 1.25 yards
Contact Leland Customer Service for yardage requirements on textiles with repeats.
For COL requirements please contact Leland Customer Experience.



Marquette Side Chair	MODEL	FRAME FINISH	LIST PRICE
Sled base, arc shell	MQS-A	Powder Coat	\$426
W 19.75 D 21 H 34 SH 18.5		Chrome	\$475

Optional Glides: Add \$8.00 net per chair for a set of four (4).



Marquette Side Chair	MODEL	LIST PRICE/GRADE	COM/COL	A	B	C	D	E	F	G	H	I	J	K	L
Sled base, arc shell upholstered seat onlay	MQSU-A	Powder Coat	\$508	530	542	553	564	576	586	597	609	620	631	642	653
		Chrome	\$557	581	592	604	614	625	637	648	659	670	681	692	703

W 19.75 D 21 H 34 SH 18.75

COM Yardage: 1, 2 or 3 seats: .75 yard; 4, 5 or 6 seats: 1.25 yards
Contact Leland Customer Service for yardage requirements on textiles with repeats.
For COL requirements please contact Leland Customer Experience.

To specify:
Please refer to pages 3-5 for complete specifying information.
Specify all products by their product code.

Pricing Effective: July 2021

MARQUETTE STACKING SIDE CHAIR, 4-LEG BASE
Design: Leland Design Group

MQ6

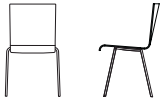

Marquette Side Chair	MODEL	FRAME FINISH	LIST PRICE
4-leg base, linear shell	MQS4-L	Powder Coat	\$464
W 19.75 D 21 H 34 SH 18.5		Chrome	\$519

Optional Glides: Add \$8.00 net per chair for a set of four (4). Optional Glides raise chair height .5 inch.



Marquette Side Chair	MODEL	LIST PRICE/GRADE	COM/COL	A	B	C	D	E	F	G	H	I	J	K	L
4-leg base, linear shell upholstered seat onlay	MQS4U-L	Powder Coat	\$545	569	580	591	603	613	624	636	647	658	668	680	691
		Chrome	\$603	625	637	648	659	670	681	692	703	715	726	736	748

W 19.75 D 21 H 34 SH 18.75

COM Yardage: 1, 2 or 3 seats: .75 yard; 4, 5 or 6 seats: 1.25 yards
Contact Leland Customer Service for yardage requirements on textiles with repeats.
For COL requirements please contact Leland Customer Experience.



Marquette Side Chair	MODEL	FRAME FINISH	LIST PRICE
4-leg base, arc shell	MQS4-A	Powder Coat	\$464
W 19.75 D 21 H 34 SH 18.5		Chrome	\$519

Optional Glides: Add \$8.00 net per chair for a set of four (4). Optional Glides raise chair height .5 inch.



Marquette Side Chair	MODEL	LIST PRICE/GRADE	COM/COL	A	B	C	D	E	F	G	H	I	J	K	L
4-leg base, arc shell upholstered seat onlay	MQS4U-A	Powder Coat	\$545	569	580	591	603	613	624	636	647	658	668	680	691
		Chrome	\$603	625	637	648	659	670	681	692	703	715	726	736	748

W 19.75 D 21 H 34 SH 18.75

COM Yardage: 1, 2 or 3 seats: .75 yard; 4, 5 or 6 seats: 1.25 yards
Contact Leland Customer Service for yardage requirements on textiles with repeats.
For COL requirements please contact Leland Customer Experience.

To specify:
Please refer to pages 3-5 for complete specifying information.
Specify all products by their product code.

Pricing Effective: July 2021

MARQUETTE COUNTER CHAIR, SLED BASE
Design: Leland Design Group

MQ7

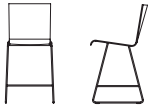

Marquette Counter Chair	MODEL	FRAME FINISH	LIST PRICE
Sled base, linear shell	MQC-L	Powder Coat	\$702
W 19.25 D 22.5 H 39.75 SH 25.25		Chrome	\$769
Optional Glides: Add \$8.00 net per chair for a set of four (4). Optional Glides raise chair height .5 inch.			

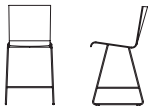

Marquette Counter Chair	MODEL	LIST PRICE/GRADE	COM/COL	A	B	C	D	E	F	G	H	I	J	K	L
Sled base, linear shell upholstered seat onlay	MQCU-L	Powder Coat	\$791	815	826	837	849	859	870	882	893	904	915	926	937
		Chrome	\$857	881	892	903	914	925	936	948	959	969	981	992	1003
W 19.25 D 22.5 H 39.75 SH 25.5	COM Yardage: 1, 2 or 3 seats: .75 yard; 4, 5 or 6 seats: 1.25 yards Contact Leland Customer Service for yardage requirements on textiles with repeats. For COL requirements please contact Leland Customer Experience.														

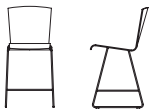

Marquette Counter Chair	MODEL	FRAME FINISH	LIST PRICE
Sled base, arc shell	MQC-A	Powder Coat	\$702
W 19.25 D 22.5 H 39.75 SH 25.25		Chrome	\$769
Optional Glides: Add \$8.00 net per chair for a set of four (4). Optional Glides raise chair height .5 inch.			



Marquette Counter Chair	MODEL	LIST PRICE/GRADE	COM/COL	A	B	C	D	E	F	G	H	I	J	K	L
Sled base, arc shell upholstered seat onlay	MQCU-A	Powder Coat	\$791	815	826	837	849	859	870	882	893	904	915	926	937
		Chrome	\$857	881	892	903	914	925	936	948	959	969	981	992	1003
W 19.25 D 22.5 H 39.75 SH 25.5	COM Yardage: 1, 2 or 3 seats: .75 yard; 4, 5 or 6 seats: 1.25 yards Contact Leland Customer Service for yardage requirements on textiles with repeats. For COL requirements please contact Leland Customer Experience.														

To specify:
Please refer to pages 3-5 for complete specifying information.
Specify all products by their product code.

Pricing Effective: July 2021

MARQUETTE COUNTER CHAIR, 4-LEG BASE
Design: Leland Design Group

MQ8

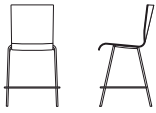

Marquette Counter Chair	MODEL	FRAME FINISH	LIST PRICE
4-leg base, linear shell W 19.25 D 22.5 H 39.75 SH 25.25	MQC4-L	Powder Coat	\$737
		Chrome	\$856

Optional Glides: Add \$8.00 net per chair for a set of four (4). Optional Glides raise chair height .5 inch.

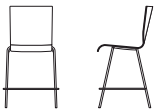

Marquette Counter Chair	MODEL	LIST PRICE/GRADE	COM/COL	A	B	C	D	E	F	G	H	I	J	K	L
4-leg base, linear shell upholstered seat onlay W 19.25 D 22.5 H 39.75 SH 25.5	MQC4U-L	Powder Coat	\$828	852	863	873	885	896	907	919	929	940	952	963	974
		Chrome	\$947	969	981	992	1003	1015	1025	1036	1048	1059	1070	1082	1092

COM Yardage: 1, 2 or 3 seats: .75 yard; 4, 5 or 6 seats: 1.25 yards
Contact Leland Customer Service for yardage requirements on textiles with repeats.
For COL requirements please contact Leland Customer Experience.



Marquette Counter Chair	MODEL	FRAME FINISH	LIST PRICE
4-leg base, arc shell W 19.25 D 22.5 H 39.75 SH 25.25	MQC4-A	Powder Coat	\$737
		Chrome	\$856

Optional Glides: Add \$8.00 net per chair for a set of four (4). Optional Glides raise chair height .5 inch.

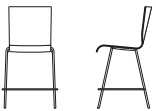

Marquette Counter Chair	MODEL	LIST PRICE/GRADE	COM/COL	A	B	C	D	E	F	G	H	I	J	K	L
4-leg base, arc shell upholstered seat onlay W 19.25 D 22.5 H 39.75 SH 25.5	MQC4U-A	Powder Coat	\$828	852	863	873	885	896	907	919	929	940	952	963	974
		Chrome	\$947	969	981	992	1003	1015	1025	1036	1048	1059	1070	1082	1092

COM Yardage: 1, 2 or 3 seats: .75 yard; 4, 5 or 6 seats: 1.25 yards
Contact Leland Customer Service for yardage requirements on textiles with repeats.
For COL requirements please contact Leland Customer Experience.

To specify:
Please refer to pages 3-5 for complete specifying information.
Specify all products by their product code.

Pricing Effective: July 2021

MARQUETTE STACKING COUNTER CHAIR, 4-LEG BASE
 Design: Leland Design Group

MQ9

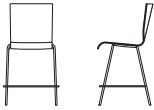

**Marquette Stacking
 Counter Chair**

	MODEL	FRAME FINISH	LIST PRICE
4-leg base, linear shell	MQCS4-L	Powder Coat	\$770
W 19.25 D 22.5 H 39.75 SH 25.25		Chrome	\$888

Optional Glides: Add \$8.00 net per chair for a set of four (4). Optional Glides raise chair height .5 inch.

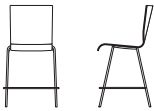

**Marquette Stacking
 Counter Chair**

	MODEL	LIST PRICE/GRADE	COM/COL	A	B	C	D	E	F	G	H	I	J	K	L
4-leg base, linear shell upholstered seat onlay	MQCS4U-L	Powder Coat	\$858	882	893	904	915	926	937	949	960	970	982	993	1004
		Chrome	\$977	1001	1012	1023	1034	1045	1057	1068	1078	1090	1101	1112	1124

W 19.25 D 22.5 H 39.75
SH 25.5

COM Yardage: 1, 2 or 3 seats: .75 yard; 4, 5 or 6 seats: 1.25 yards
 Contact Leland Customer Service for yardage requirements on textiles with repeats.
 For COL requirements please contact Leland Customer Experience.



**Marquette Stacking
 Counter Chair**

	MODEL	FRAME FINISH	LIST PRICE
4-leg base, arc shell	MQCS4-A	Powder Coat	\$748
W 19.25 D 22.5 H 39.75 SH 25.25		Chrome	\$862

Optional Glides: Add \$8.00 net per chair for a set of four (4). Optional Glides raise chair height .5 inch.



**Marquette Stacking
 Counter Chair**

	MODEL	LIST PRICE/ GRADE	COM/COL	A	B	C	D	E	F	G	H	I	J	K	L
4-leg base, arc shell upholstered seat onlay	MQCS4U-A	Powder Coat	\$858	882	893	904	915	926	937	949	960	970	982	993	1004
		Chrome	\$977	1001	1012	1023	1034	1045	1057	1068	1078	1090	1101	1112	1124

W 19.25 D 22.5 H 39.75
SH 25.5

COM Yardage: 1, 2 or 3 seats: .75 yard; 4, 5 or 6 seats: 1.25 yards
 Contact Leland Customer Service for yardage requirements on textiles with repeats.
 For COL requirements please contact Leland Customer Experience.

To specify:
 Please refer to pages 3-5 for complete specifying information.
 Specify all products by their product code.

MARQUETTE BAR CHAIR, SLED BASE
Design: Leland Design Group

MQ10

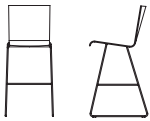

Marquette Bar Chair	MODEL	FRAME FINISH	LIST PRICE
sled base, linear shell W 19.5 D 23 H 44 SH 30.25	MQB-L	Powder Coat	\$717
		Chrome	\$797

Optional Glides: Add \$8.00 net per chair for a set of four (4). Optional Glides raise chair height .5 inch.

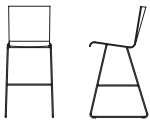

Marquette Bar Chair	MODEL	LIST PRICE/GRADE	COM/COL	A	B	C	D	E	F	G	H	I	J	K	L
Sled base, linear shell upholstered seat onlay W 19.5 D 23 H 44 SH 30.5	MQBU-L	Powder Coat	\$804	828	839	851	861	872	884	895	906	918	928	939	951
		Chrome	\$887	911	922	933	945	955	966	977	989	1000	1010	1022	1033

COM Yardage: 1, 2 or 3 seats: .75 yard; 4, 5 or 6 seats: 1.25 yards
Contact Leland Customer Service for yardage requirements on textiles with repeats.
For COL requirements please contact Leland Customer Experience.

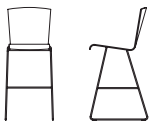

Marquette Bar Chair	MODEL	FRAME FINISH	LIST PRICE
Sled base, arc shell W 19.5 D 23 H 44 SH 30.25	MQB-A	Powder Coat	\$717
		Chrome	\$797

Optional Glides: Add \$8.00 net per chair for a set of four (4). Optional Glides raise chair height .5 inch.



Marquette Bar Chair	MODEL	LIST PRICE/ GRADE	COM/COL	A	B	C	D	E	F	G	H	I	J	K	L
Sled base, arc shell upholstered seat onlay W 19.5 D 23 H 44 SH 30.5	MQBU-A	Powder Coat	\$804	828	839	851	861	872	884	895	906	918	928	939	951
		Chrome	\$887	911	922	933	945	955	966	977	989	1000	1010	1022	1033

COM Yardage: 1, 2 or 3 seats: .75 yard; 4, 5 or 6 seats: 1.25 yards
Contact Leland Customer Service for yardage requirements on textiles with repeats.
For COL requirements please contact Leland Customer Experience.

To specify:
Please refer to pages 3-5 for complete specifying information.
Specify all products by their product code.

Pricing Effective: July 2021

MARQUETTE BAR CHAIR, 4-LEG BASE
 Design: Leland Design Group

MQ11



Marquette Bar Chair	MODEL	FRAME FINISH	LIST PRICE
4-leg base, linear shell W 19.5 D 23 H 44 SH 30.25	MQB4-L	Powder Coat	\$756
		Chrome	\$877

Optional Glides: Add \$8.00 net per chair for a set of four (4). Optional Glides raise chair height .5 inch.



Marquette Bar Chair	MODEL	LIST PRICE/ GRADE	COM/COL	A	B	C	D	E	F	G	H	I	J	K	L
4-leg base, linear shell upholstered seat onlay W 19.5 D 23 H 44 SH 30.5	MQB4U-L	Powder Coat	\$843	866	878	888	899	911	922	933	945	955	966	977	989
		Chrome	\$963	987	997	1008	1020	1031	1042	1054	1064	1075	1087	1098	1109

COM Yardage: 1, 2 or 3 seats: .75 yard; 4, 5 or 6 seats: 1.25 yards
 Contact Leland Customer Service for yardage requirements on textiles with repeats.
 For COL requirements please contact Leland Customer Experience.



Marquette Bar Chair	MODEL	FRAME FINISH	LIST PRICE
4-leg base, arc shell W 19.5 D 23 H 44 SH 30.25	MQB4-A	Powder Coat	\$756
		Chrome	\$877

Optional Glides: Add \$8.00 net per chair for a set of four (4). Optional Glides raise chair height .5 inch.



Marquette Bar Chair	MODEL	LIST PRICE/ GRADE	COM/COL	A	B	C	D	E	F	G	H	I	J	K	L
4-leg base, arc shell upholstered seat onlay W 19.5 D 23 H 44 SH 30.5	MQB4U-A	Powder Coat	\$843	866	878	888	899	911	922	933	945	955	966	977	989
		Chrome	\$963	987	997	1008	1020	1031	1042	1054	1064	1075	1087	1098	1109

COM Yardage: 1, 2 or 3 seats: .75 yard; 4, 5 or 6 seats: 1.25 yards
 Contact Leland Customer Service for yardage requirements on textiles with repeats.
 For COL requirements please contact Leland Customer Experience.

To specify:
 Please refer to pages 3-5 for complete specifying information.
 Specify all products by their product code.

Pricing Effective: July 2021

MARQUETTE STACKING BAR CHAIR, 4-LEG BASE
 Design: Leland Design Group

MQ12

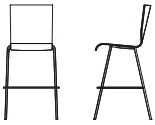

**Marquette
Stacking Bar Chair**

	MODEL	FRAME FINISH	LIST PRICE
4-leg base, linear shell	MQBS4-L	Powder Coat	\$787
W 19.5 D 23 H 44 SH 30.25		Chrome	\$907

Optional Glides: Add \$8.00 net per chair for a set of four (4). Optional Glides raise chair height .5 inch.

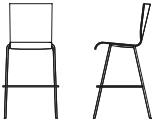

**Marquette
Stacking Bar Chair**

	MODEL	LIST PRICE/ GRADE	COM/COL	A	B	C	D	E	F	G	H	I	J	K	L
4-leg base, linear shell upholstered seat onlay	MQBS4U-L	Powder Coat	\$874	898	909	921	932	942	954	965	976	988	999	1009	1021
		Chrome	\$995	1019	1030	1041	1052	1063	1074	1086	1097	1108	1119	1130	1141

W 19.5 D 23 H 44 SH 30.5

COM Yardage: 1, 2 or 3 seats: .75 yard; 4, 5 or 6 seats: 1.25 yards
 Contact Leland Customer Service for yardage requirements on textiles with repeats.
 For COL requirements please contact Leland Customer Experience.



**Marquette
Stacking Bar Chair**

	MODEL	FRAME FINISH	LIST PRICE
4-leg base, arc shell	MQBS4-A	Powder Coat	\$787
W 19.5 D 23 H 44 SH 30.25		Chrome	\$907

Optional Glides: Add \$8.00 net per chair for a set of four (4). Optional Glides raise chair height .5 inch.



**Marquette
Stacking Bar Chair**

	MODEL	LIST PRICE/ GRADE	COM/COL	A	B	C	D	E	F	G	H	I	J	K	L
4-leg base, arc shell upholstered seat onlay	MQBS4U-A	Powder Coat	\$874	898	909	921	932	942	954	965	976	988	999	1009	1021
		Chrome	\$995	1019	1030	1041	1052	1063	1074	1086	1097	1108	1119	1130	1141

W 19.5 D 23 H 44 SH 30.5

COM Yardage: 1, 2 or 3 seats: .75 yard; 4, 5 or 6 seats: 1.25 yards
 Contact Leland Customer Service for yardage requirements on textiles with repeats.
 For COL requirements please contact Leland Customer Experience.

To specify:
 Please refer to pages 3-5 for complete specifying information.
 Specify all products by their product code.

Pricing Effective: July 2021

LITTLE MARQUETTE SIDE CHAIR
Design: Leland Design Group

MQ13



**Little Marquette
Side Chair**

	MODEL	FRAME FINISH	LIST PRICE
Sled base, arc shell	MQL-A	Powder Coat	\$487
W 16 D 19 H 28 SH 15		Chrome	\$519

Optional Glides: Add \$8.00 net per chair for a set of four (4).
Powder Coat: Black or Sterling only.



**Little Marquette
Side Chair**

	MODEL	FRAME FINISH	LIST PRICE
Sled base, crescent shell	MQL-C	Powder Coat	\$487
W 16 D 19 H 28 SH 15		Chrome	\$519

Optional Glides: Add \$8.00 net per chair for a set of four (4).
Powder Coat: Black or Sterling only.

BACK CUT OUTS AVAILABLE FOR THE LITTLE MARQUETTE:

SWAMP THINGS SERIES	CODE	GEOMETRIC SERIES	CODE	PETROGLYPH SERIES	CODE	CELESTIAL SERIES	CODE
Lizard	1S	Shapes	1G	Deer	1P	Saturn	1C
Tree Frog	2S	Circle	2G	Antelope	2P	Shooting Star	2C
Turtle	3S	Square	3G	Ram	3P	Starry Night	3C
Snake	4S	Triangle	4G	Horse	4P	Moon	4C

To specify:
Please refer to pages 3-5 for complete specifying information.
Specify all products by their product code.

Pricing Effective: July 2021

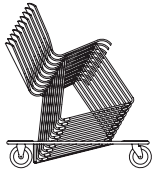

**Marquette Transport/
Stacking Dolly**

	MODEL	FRAME FINISH	LIST PRICE
W 23 D 33 H 6 (empty)	MQD	Powder Coat	\$928
W 23 D 33 H 38 (with 10 slide chairs)		Marquette Transport/Stacking Dolly handles up to 10 Marquette side chairs with sled base or 4-leg base.	

**PROPER STACKING OF MARQUETTE SLED BASE CHAIRS
(10 CHAIRS MAXIMUM)**

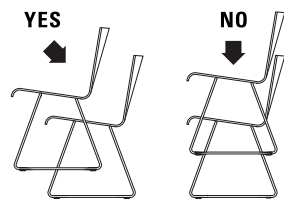

To specify:
 Please refer to pages 3-5 for complete specifying information.
 Specify all products by their product code.

**5695 Eagle Drive, SE
Grand Rapids,
Michigan 49512
616-975-9260
lelandfurniture.com**

MASS

July 2021 Price List



MASS

Table of Contents	MA2
Specification Information	MA3
Specification Example	MA4
Stacking Side Chair	MA5
Stacking Side Chair, Upholstered Seat	MA6
Stacking Arm Chair	MA7
Stacking Arm Chair, Upholstered Seat	MA8
Stacking Counter Chair	MA9
Stacking Counter Chair, Upholstered Seat	MA10
Stacking Bar Chair	MA11
Stacking Bar Chair, Upholstered Seat	MA12
Transport/Stacking Dolly	MA13

Chair Model

DESCRIPTION	CODE
MASS stacking side chair	MASS
MASS stacking side chair, upholstered seat	MASSU
MASS stacking arm chair	MASA
MASS stacking arm chair, upholstered seat	MASAU
MASS stacking counter chair	MASC
MASS stacking counter chair, upholstered seat	MASCU
MASS stacking bar chair	MASB
MASS stacking bar chair, upholstered seat	MASBU
MASS transport/stacking dolly	MASD

Seat/Back Color

POLYPROPYLENE SHELL:

DESCRIPTION	CODE
White	WT
Recycled Black	RB
Grey	G
Pistachio	PS

CUSTOM POLYPROPYLENE COLORS

Custom color match is available upon request. Please contact hello@lelandfurniture.com for further information

Onlay Selection

Please refer to Leland Textile Program which features textiles and leathers from the following partners:

- Camira
- Carnegie
- CF Stinson
- Green Hides
- Maharam
- Unika Vaev

The complete grade list can be found at www.lelandfurniture.com/resources or you can specify COM/COL. Due to the design of this product, it is recommended that all non pre-approved textile be tested for compatibility.

Frame Finish

DESCRIPTION	CODE
Chrome	C
Sterling	ST
White Textured	WT
Black Textured	BT
Grey Textured	GT
Black	B
White	W

Glide Type

STANDARD GLIDE:

DESCRIPTION	CODE
Nylon	S

OPTIONAL GLIDE:

DESCRIPTION	CODE
Felt	F

Stacking Note

MASS side chair, arm chair and bar chair models stack as follows (includes upholstered):

SIDE CHAIR:

Floor: 15 High
Dolly: 40 High

ARM CHAIR:

Floor: 12 High
Dolly: 40 High

BAR & COUNTER CHAIR:

Floor: 8 High

Chair Weight

SIDE CHAIR: 12 lbs

ARM CHAIR: 14 lbs

Specifications required to create the product code

- Model
- Shell Finish
- Upholstered Onlay Selection (when applicable)
- Frame Finish
- Glide or Caster Type

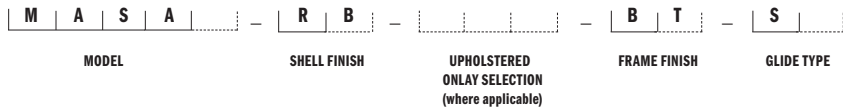

MODEL

MASS stacking arm chair (MASA)

SHELL FINISH

Recycled Black (RB)

UPHOLSTERED ONLAY SELECTION

When applicable, enter upholstery grade, COM



FRAME FINISH

Black Textured (BT)

GLIDE TYPE

Standard Nylon (S)



MASS STACKING SIDE CHAIR
 Design: ITEMdesignworks, licensed by Sellex

MA5



PRICING FOR QUANTITIES 1-99

MASS Stacking Side Chair	MODEL	FRAME FINISH	LIST PRICE
Polypropylene shell	MASS	Powder Coat	\$325
W 20.5 D 20.5 H 32.25 SH 18.75		Chrome	\$381

Optional Glides: Add \$8.00 net per chair for a set of four (4). Optional glides raise chair height .5 inch.



PRICING FOR QUANTITIES 100-299

MASS Stacking Side Chair	MODEL	FRAME FINISH	LIST PRICE
Polypropylene shell	MASS	Powder Coat	\$310
W 20.5 D 20.5 H 32.25 SH 18.75		Chrome	\$360

Optional Glides: Add \$8.00 net per chair for a set of four (4). Optional glides raise chair height .5 inch.



PRICING FOR QUANTITIES 300+

MASS Stacking Side Chair	MODEL	FRAME FINISH	LIST PRICE
Polypropylene shell	MASS	Powder Coat	\$290
W 20.5 D 20.5 H 32.25 SH 18.75		Chrome	\$340

Optional Glides: Add \$8.00 net per chair for a set of four (4). Optional glides raise chair height .5 inch.

To specify:
 Please refer to pages 3-4 for complete specifying information.
 Specify all products by their product code.

Pricing Effective: July 2021

MASS STACKING SIDE CHAIR, UPHOLSTERED SEAT
 Design: ITEMdesignworks, licensed by Sellex

MA6



PRICING FOR QUANTITIES 1-99

MASS Stacking Side Chair	MODEL	LIST PRICE/GRADE	COM/COL	A	B	C	D	E	F	G	H	I	J	K	L
Polypropylene shell, upholstered seat onlay	MASSU	Powder Coat	\$448	479	510	541	572	603	634	665	696	727	758	789	820
		Chrome	\$504	535	566	597	628	659	690	721	752	783	814	845	876

W 20.5 D 20.5 H 32.25 SH 18.75

Optional Glides: Add \$8.00 net per chair for a set of four (4). Optional glides raise chair height .5 inch.
 COM Yardage: 1-3 seats: .5 yard
 Contact Leland Customer Experience for yardage requirements on textiles with repeats.
 For COL requirements please contact Leland Customer Experience.



PRICING FOR QUANTITIES 100-299

MASS Stacking Side Chair	MODEL	LIST PRICE/GRADE	COM/COL	A	B	C	D	E	F	G	H	I	J	K	L
Polypropylene shell, upholstered seat onlay	MASSU	Powder Coat	\$422	453	484	515	546	577	608	639	670	701	732	763	794
		Chrome	\$475	506	537	568	599	630	661	692	723	754	785	816	847

W 20.5 D 20.5 H 32.25 SH 18.75

Optional Glides: Add \$8.00 net per chair for a set of four (4). Optional glides raise chair height .5 inch.
 COM Yardage: 1-3 seats: .5 yard
 Contact Leland Customer Experience for yardage requirements on textiles with repeats.
 For COL requirements please contact Leland Customer Experience.



PRICING FOR QUANTITIES 300+

MASS Stacking Side Chair	MODEL	LIST PRICE/GRADE	COM/COL	A	B	C	D	E	F	G	H	I	J	K	L
Polypropylene shell, upholstered seat onlay	MASSU	Powder Coat	\$399	430	461	492	523	554	585	616	647	678	709	740	771
		Chrome	\$449	480	511	542	573	604	635	666	697	728	759	790	821

W 20.5 D 20.5 H 32.25 SH 18.75

Optional Glides: Add \$8.00 net per chair for a set of four (4). Optional glides raise chair height .5 inch.
 COM Yardage: 1-3 seats: .5 yard
 Contact Leland Customer Experience for yardage requirements on textiles with repeats.
 For COL requirements please contact Leland Customer Experience.

To specify:
 Please refer to pages 3-4 for complete specifying information.
 Specify all products by their product code.

Pricing Effective: July 2021

MASS STACKING ARM CHAIR
 Design: ITEMdesignworks, licensed by Sellex

MA7



PRICING FOR QUANTITIES 1-99

MASS Stacking Arm Chair	MODEL	FRAME FINISH	LIST PRICE
Polypropylene shell	MASA	Powder Coat	\$450
W 20.5 D 20.5 H 32.25 SH 18.75		Chrome	\$505

Optional Glides: Add \$8.00 net per chair for a set of four (4). Optional glides raise chair height .5 inch.



PRICING FOR QUANTITIES 100-299

MASS Stacking Arm Chair	MODEL	FRAME FINISH	LIST PRICE
Polypropylene shell	MASA	Powder Coat	\$422
W 20.5 D 20.5 H 32.25 SH 18.75		Chrome	\$479

Optional Glides: Add \$8.00 net per chair for a set of four (4). Optional glides raise chair height .5 inch.



PRICING FOR QUANTITIES 300+

MASS Stacking Arm Chair	MODEL	FRAME FINISH	LIST PRICE
Polypropylene shell	MASA	Powder Coat	\$400
W 20.5 D 20.5 H 32.25 SH 18.75		Chrome	\$449

Optional Glides: Add \$8.00 net per chair for a set of four (4). Optional glides raise chair height .5 inch.

To specify:
 Please refer to pages 3-4 for complete specifying information.
 Specify all products by their product code.

Pricing Effective: July 2021

MASS STACKING ARM CHAIR, UPHOLSTERED SEAT
 Design: ITEMdesignworks, licensed by Sellex

MA8



PRICING FOR QUANTITIES 1-99

MASS Stacking Arm Chair	MODEL	LIST PRICE/GRADE	COM/COL	A	B	C	D	E	F	G	H	I	J	K	L
Polypropylene shell, upholstered seat onlay	MASAU	Powder Coat	\$525	556	587	618	649	680	711	742	773	804	835	866	897
		Chrome	\$583	614	645	676	707	738	769	800	831	862	893	924	955

W 20.5 D 20.5 H 32.25 SH 18.75

Optional Glides: Add \$8.00 net per chair for a set of four (4). Optional glides raise chair height .5 inch.
 COM Yardage: 1-3 seats: .5 yard
 Contact Leland Customer Experience for yardage requirements on textiles with repeats.
 For COL requirements please contact Leland Customer Experience.



PRICING FOR QUANTITIES 100-299

MASS Stacking Arm Chair	MODEL	LIST PRICE/GRADE	COM/COL	A	B	C	D	E	F	G	H	I	J	K	L
Polypropylene shell, upholstered seat onlay	MASAU	Powder Coat	\$496	527	558	589	620	651	682	713	744	775	806	837	868
		Chrome	\$551	582	613	644	675	706	737	768	799	830	861	892	923

W 20.5 D 20.5 H 32.25 SH 18.75

Optional Glides: Add \$8.00 net per chair for a set of four (4). Optional glides raise chair height .5 inch.
 COM Yardage: 1-3 seats: .5 yard
 Contact Leland Customer Experience for yardage requirements on textiles with repeats.
 For COL requirements please contact Leland Customer Experience.



PRICING FOR QUANTITIES 300+

MASS Stacking Arm Chair	MODEL	LIST PRICE/GRADE	COM/COL	A	B	C	D	E	F	G	H	I	J	K	L
Polypropylene shell, upholstered seat onlay	MASAU	Powder Coat	\$468	499	530	561	592	623	654	685	716	747	778	809	840
		Chrome	\$519	550	581	612	643	674	705	736	767	798	829	860	891

W 20.5 D 20.5 H 32.25 SH 18.75

Optional Glides: Add \$8.00 net per chair for a set of four (4). Optional glides raise chair height .5 inch.
 COM Yardage: 1-3 seats: .5 yard
 Contact Leland Customer Experience for yardage requirements on textiles with repeats.
 For COL requirements please contact Leland Customer Experience.

To specify:
 Please refer to pages 3-4 for complete specifying information.
 Specify all products by their product code.

Pricing Effective: July 2021

MASS STACKING COUNTER CHAIR
 Design: ITEMdesignworks, licensed by Sellex

MA9



PRICING FOR QUANTITIES 1-99

MASS Stacking Counter Chair	MODEL	FRAME FINISH	LIST PRICE
Polypropylene shell	MASC	Powder Coat	\$581
W 21.75 D 20.5 H 40.75 SH 25		Chrome	\$637

Optional Glides: Add \$8.00 net per chair for a set of four (4). Optional glides raise chair height .5 inch.



PRICING FOR QUANTITIES 100-299

MASS Stacking Counter Chair	MODEL	FRAME FINISH	LIST PRICE
Polypropylene shell	MASC	Powder Coat	\$549
W 21.75 D 20.5 H 40.75 SH 25		Chrome	\$602

Optional Glides: Add \$8.00 net per chair for a set of four (4). Optional glides raise chair height .5 inch.



PRICING FOR QUANTITIES 300+

MASS Stacking Counter Chair	MODEL	FRAME FINISH	LIST PRICE
Polypropylene shell	MASC	Powder Coat	\$517
W 21.75 D 20.5 H 40.75 SH 25		Chrome	\$550

Optional Glides: Add \$8.00 net per chair for a set of four (4). Optional glides raise chair height .5 inch.

To specify:
 Please refer to pages 3-4 for complete specifying information.
 Specify all products by their product code.

Pricing Effective: July 2021

MASS STACKING COUNTER CHAIR, UPHOLSTERED SEAT
 Design: ITEMdesignworks, licensed by Sellex

MA10



PRICING FOR QUANTITIES 1-99

MASS Stacking Counter Chair

MODEL	LIST PRICE/GRADE	COM/COL	A	B	C	D	E	F	G	H	I	J	K	L	
Polypropylene shell, upholstered seat onlay	MASCUC	Powder Coat	\$697	728	758	788	818	848	878	908	938	968	998	1028	1058
		Chrome	\$754	784	814	844	874	904	934	964	994	1024	1054	1084	1115

W 21.75 D 20.5 H 40.75 SH 25

Optional Glides: Add \$8.00 net per chair for a set of four (4). Optional glides raise chair height .5 inch.
 COM Yardage: 1-3 seats: .5 yard
 Contact Leland Customer Experience for yardage requirements on textiles with repeats.
 For COL requirements please contact Leland Customer Experience.

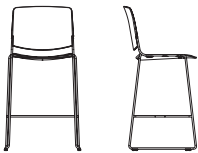

PRICING FOR QUANTITIES 100-299

MASS Stacking Counter Chair

MODEL	LIST PRICE/GRADE	COM/COL	A	B	C	D	E	F	G	H	I	J	K	L	
Polypropylene shell, upholstered seat onlay	MASCUC	Powder Coat	\$658	688	718	748	778	808	838	868	898	928	958	988	1019
		Chrome	\$713	743	773	803	833	863	893	923	954	984	1014	1044	1074

W 21.75 D 20.5 H 40.75 SH 25

Optional Glides: Add \$8.00 net per chair for a set of four (4). Optional glides raise chair height .5 inch.
 COM Yardage: 1-3 seats: .5 yard
 Contact Leland Customer Experience for yardage requirements on textiles with repeats.
 For COL requirements please contact Leland Customer Experience.



PRICING FOR QUANTITIES 300+

MASS Stacking Counter Chair

MODEL	LIST PRICE/GRADE	COM/COL	A	B	C	D	E	F	G	H	I	J	K	L	
Polypropylene shell, upholstered seat onlay	MASCUC	Powder Coat	\$620	650	680	710	740	770	800	830	860	890	921	951	981
		Chrome	\$670	700	730	760	791	821	851	881	911	941	971	1001	1031

W 21.75 D 20.5 H 40.75 SH 25

Optional Glides: Add \$8.00 net per chair for a set of four (4). Optional glides raise chair height .5 inch.
 COM Yardage: 1-3 seats: .5 yard
 Contact Leland Customer Experience for yardage requirements on textiles with repeats.
 For COL requirements please contact Leland Customer Experience.

To specify:

Please refer to pages 3-4 for complete specifying information.
 Specify all products by their product code.

Pricing Effective: July 2021

MASS STACKING BAR CHAIR
 Design: ITEMdesignworks, licensed by Sellex

MA11



PRICING FOR QUANTITIES 1-99

MASS Stacking Bar Chair		MODEL	FRAME FINISH	LIST PRICE
Polypropylene shell		MASB	Powder Coat	\$599
W 21.75	D 20.5 H 40.75 SH 29		Chrome	\$657

Optional Glides: Add \$8.00 net per chair for a set of four (4). Optional glides raise chair height .5 inch.



PRICING FOR QUANTITIES 100-299

MASS Stacking Bar Chair		MODEL	FRAME FINISH	LIST PRICE
Polypropylene shell		MASB	Powder Coat	\$566
W 21.75	D 20.5 H 40.75 SH 29		Chrome	\$621

Optional Glides: Add \$8.00 net per chair for a set of four (4). Optional glides raise chair height .5 inch.



PRICING FOR QUANTITIES 300+

MASS Stacking Bar Chair		MODEL	FRAME FINISH	LIST PRICE
Polypropylene shell		MASB	Powder Coat	\$533
W 21.75	D 20.5 H 40.75 SH 29		Chrome	\$567

Optional Glides: Add \$8.00 net per chair for a set of four (4). Optional glides raise chair height .5 inch.

To specify:
 Please refer to pages 3-4 for complete specifying information.
 Specify all products by their product code.

Pricing Effective: July 2021

MASS STACKING BAR CHAIR, UPHOLSTERED SEAT
 Design: ITEMdesignworks, licensed by Sellex

MA12



PRICING FOR QUANTITIES 1-99

MASS Stacking Bar Chair

Polypropylene shell,
upholstered seat onlay

MODEL	LIST PRICE/GRADE	COM/COL	A	B	C	D	E	F	G	H	I	J	K	L
MASBU	Powder Coat	\$719	750	781	812	843	874	905	936	967	998	1029	1060	1091
	Chrome	\$777	808	839	870	901	932	963	994	1025	1056	1087	1118	1149

W 21.75 D 20.5 H 40.75 SH 29

Optional Glides: Add \$8.00 net per chair for a set of four (4). Optional glides raise chair height .5 inch.
 COM Yardage: 1-3 seats: .5 yard
 Contact Leland Customer Experience for yardage requirements on textiles with repeats.
 For COL requirements please contact Leland Customer Experience.

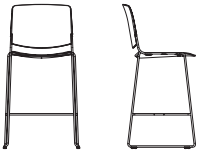

PRICING FOR QUANTITIES 100-299

MASS Stacking Bar Chair

Polypropylene shell,
upholstered seat onlay

MODEL	LIST PRICE/GRADE	COM/COL	A	B	C	D	E	F	G	H	I	J	K	L
MASBU	Powder Coat	\$678	709	740	771	802	833	864	895	926	957	988	1019	1050
	Chrome	\$735	766	797	828	859	890	921	952	983	1014	1045	1076	1107

W 21.75 D 20.5 H 40.75 SH 29

Optional Glides: Add \$8.00 net per chair for a set of four (4). Optional glides raise chair height .5 inch.
 COM Yardage: 1-3 seats: .5 yard
 Contact Leland Customer Experience for yardage requirements on textiles with repeats.
 For COL requirements please contact Leland Customer Experience.

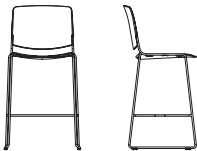

PRICING FOR QUANTITIES 300+

MASS Stacking Bar Chair

Polypropylene shell,
upholstered seat onlay

MODEL	LIST PRICE/GRADE	COM/COL	A	B	C	D	E	F	G	H	I	J	K	L
MASBU	Powder Coat	\$639	670	701	732	763	794	825	856	887	918	949	980	1011
	Chrome	\$691	722	753	784	815	846	877	908	939	970	1001	1032	1063

W 21.75 D 20.5 H 40.75 SH 29

Optional Glides: Add \$8.00 net per chair for a set of four (4). Optional glides raise chair height .5 inch.
 COM Yardage: 1-3 seats: .5 yard
 Contact Leland Customer Experience for yardage requirements on textiles with repeats.
 For COL requirements please contact Leland Customer Experience.

To specify:
 Please refer to pages 3-4 for complete specifying information.
 Specify all products by their product code.

Pricing Effective: July 2021

MASS TRANSPORT/STACKING DOLLY
Design: ITEMdesignworks, licensed by Sellex

MA13



MASS Transport/Stacking Dolly	MODEL	FRAME FINISH	LIST PRICE
Black powder coat finish	MASD		\$897
W 34.5 D 23 H 17 (Dimensions of dolly when empty)		MASS Transport/Stacking Dolly capacity: 40 high (15 high on floor) For use with Side and Arm Chair models (including upholstered) **Bar and Counter models do not stack on dolly	
W 41.25 D 23 H 65.25 (Dimensions with 40 poly chair stack)			

To specify:
Please refer to pages 3-4 for complete specifying information.
Specify all products by their product code.

Pricing Effective: July 2021

5695 Eagle Drive, SE
Grand Rapids,
Michigan 49512
616-975-9260
lelandfurniture.com

Omena

July 2021 Price List



Omena

Table of Contents	OM2
Specification Information	OM3
Specification Example	OM4
Side Chair	OM5
Counter Stool	OM7
Bar Stool	OM8
Low Stool	OM9

Chair Model

DESCRIPTION	CODE
Omena side chair	OMSW
Omena side chair, upholstered seat	OMSWU
Omena side chair, upholstered seat and back	OMSWUU
Omena counter stool	OMCW
Omena counter stool, upholstered seat	OMCWU
Omena bar stool	OMBW
Omena bar stool, upholstered seat	OMBWU
Omena low stool	OMLW
Omena low stool, upholstered seat	OMLWU

Shell Veneer

DESCRIPTION	CODE
Maple (standard)	M
Oak (premium)	O

Shell Leg/Finish

STANDARD SHELL/LEG (MAPLE):

STANDARD LELAND COLORS

CUSTOM SPECIFY Custom (01)

OAK SHELL/BASE:

DESCRIPTION	CODE
Morel	66M
Weathered	68M
Dune	69M
Trillium	70M

GRADIENT FINISHES

DESCRIPTION	CODE
Blue Sky Gradient BG	90MG
Forest Gradient FG	86MG
Gravel Gradient GG	87MG
Dawn Gradient DG	88MG
Heather Gradient HG	99MG

Gradient Finishes applied on maple shell/leg only and are only offered on Omena side chair and low stool.

Upholstery Selection

Please refer to Leland Textile Program which features textiles and leathers from the following partners:

- Camira
- Green Hides
- Carnegie
- Maharam
- CF Stinson
- Unika Vaev

The complete grade list can be found on our website or you can specify COM/COL. Due to the design of this product, it is recommended that all non pre-approved textile be tested for compatibility.

Glide Type

STANDARD:

DESCRIPTION	CODE
Rubber	S

OPTIONAL:

Please note that optional glides raise the chair height .5 inch.

DESCRIPTION	CODE
Felt	FC

Stacking note

The Omena chair/stool does not stack.

Specifications required to create the product code

- Model
- Wood Species
- Shell Finish
- Seat Upholstery Selection (when applicable)
- Leg Finish
- Back Upholstery Selection (when applicable)
- Glide Type

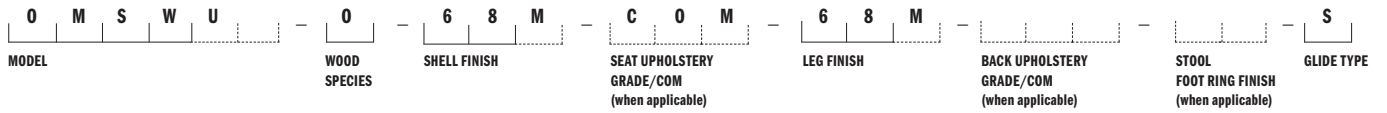

MODEL

Omena Side Chair, Upholstered Seat (OMSWU)

WOOD SPECIES

Oak (O)

SHELL FINISH

Weathered (68M)

SEAT UPHOLSTERY SELECTION

When applicable, enter upholstery grade, COM

LEG FINISH

Weathered (68M)

BACK UPHOLSTERY SELECTION

When applicable, enter upholstery grade, COM



OMENA SIDE CHAIR
Design: 2B Studio, Will Oltman

OM5



Omena Side Chair

	MODEL	LIST PRICE
Maple shell/base	OMSW-M	\$672
W 17.5 D 21 H 31 SH 18		

Optional Glides: Add \$8.00 net per chair for a set of four (4). Optional Glides raise chair height .5 inch.
Gradient Finishes Upcharge: \$168 List



Omena Side Chair

	MODEL	LIST PRICE/GRADE	COM/COL	A	B	C	D	E	F	G	H	I	J	K	L
Maple shell/base, upholstered seat	OMSWU-M		\$798	835	854	873	892	911	930	949	968	987	1006	1025	1044
W 17.5 D 21 H 31 SH 18.5															

Optional Glides: Add \$8.00 net per chair for a set of four (4). Optional Glides raise chair height .5 inch.
Gradient Finishes Upcharge: \$168 List
COM Yardage: 0.5 yards, 1-2 seats
Contact Leland Customer Experience for yardage requirements on textiles with repeats.
For COL requirements please contact Leland Customer Experience.



Omena Side Chair

	MODEL	LIST PRICE/GRADE	COM/COL	A	B	C	D	E	F	G	H	I	J	K	L
Maple shell/base, upholstered seat and back	OMSWUU-M		\$924	998	1035	1072	1109	1146	1183	1220	1257	1294	1331	1368	1405
W 17.5 D 21 H 31 SH 18.5															

Optional Glides: Add \$8.00 net per chair for a set of four (4). Optional Glides raise chair height .5 inch.
Gradient Finishes Upcharge: \$168 List
1 yard, 1-2 seat and backs
Contact Leland Customer Experience for yardage requirements on textiles with repeats.
For COL requirements please contact Leland Customer Experience.

To specify:
Please refer to pages 3-4 for complete specifying information.
Specify all products by their product code.

Pricing Effective: July 2021

OMENA SIDE CHAIR
Design: 2B Studio, Will Oltman

OM6



Omena Side Chair	MODEL	LIST PRICE
Oak shell/base	OMSW-0	\$734
W 17.5 D 21 H 31 SH 18	Optional Glides: Add \$8.00 net per chair for a set of four (4). Optional Glides raise chair height .5 inch.	



Omena Side Chair	MODEL	LIST PRICE/GRADE	COM/COL	A	B	C	D	E	F	G	H	I	J	K	L
Oak shell/base, upholstered seat	OMSWU-0		\$860	897	916	935	954	973	992	1011	1030	1049	1068	1087	1106
W 17.5 D 21 H 31 SH 18.5	Optional Glides: Add \$8.00 net per chair for a set of four (4). Optional Glides raise chair height .5 inch. COM Yardage: 0.5 yards, 1-2 seats Contact Leland Customer Experience for yardage requirements on textiles with repeats. For COL requirements please contact Leland Customer Experience.														



Omena Side Chair	MODEL	LIST PRICE/GRADE	COM/COL	A	B	C	D	E	F	G	H	I	J	K	L
Oak shell/base, upholstered seat and back	OMSWUU-0		\$986	1060	1097	1134	1171	1208	1245	1282	1319	1356	1393	1430	1467
W 17.5 D 21 H 31 SH 18.5	Optional Glides: Add \$8.00 net per chair for a set of four (4). Optional Glides raise chair height .5 inch. 1 yard, 1-2 seat and backs Contact Leland Customer Experience for yardage requirements on textiles with repeats. For COL requirements please contact Leland Customer Experience.														

To specify:
Please refer to pages 3-4 for complete specifying information.
Specify all products by their product code.

Pricing Effective: July 2021

OMENA COUNTER STOOL
Design: 2B Studio, Will Oltman

OM7



Omena Counter Stool

MODEL

LIST PRICE

Maple shell

OMCW-M

\$1154

W 17.5 D 21 H 31 SH 25

Optional Glides: Add \$8.00 net per chair for a set of four (4). Optional Glides raise chair height .5 inch.



Omena Counter Stool

MODEL

LIST PRICE/
GRADE

COM/COL

A

B

C

D

E

F

G

H

I

J

K

L

Maple shell,
upholstered seat

OMCWU-M

\$1261

1298

1317

1336

1355

1374

1393

1412

1431

1450

1469

1488

1507

W 17.5 D 21 H 31 SH 25.5

Optional Glides: Add \$8.00 net per chair for a set of four (4). Optional Glides raise chair height .5 inch.
COM yardage: 0.5 yards, 1-2 seats
Contact Leland Customer Experience for yardage requirements on textiles with repeats.
For COL requirements please contact Leland Customer Experience.



Omena Counter Stool

MODEL

LIST PRICE

Oak shell

OMCW-O

\$1292

W 17.5 D 21 H 31 SH 25

Optional Glides: Add \$8.00 net per chair for a set of four (4). Optional Glides raise chair height .5 inch.



Omena Counter Stool

MODEL

LIST PRICE/
GRADE

COM/COL

A

B

C

D

E

F

G

H

I

J

K

L

Oak shell,
upholstered seat

OMCWU-O

\$1400

1437

1456

1475

1494

1513

1532

1551

1570

1589

1608

1627

1646

W 17.5 D 21 H 31 SH 25.5

Optional Glides: Add \$8.00 net per chair for a set of four (4). Optional Glides raise chair height .5 inch.
COM yardage: 0.5 yards, 1-2 seats
Contact Leland Customer Experience for yardage requirements on textiles with repeats.
For COL requirements please contact Leland Customer Experience.

To specify:

Please refer to pages 3-4 for complete specifying information. Specify all products by their product code.

Pricing Effective: July 2021

OMENA BAR STOOL
Design: 2B Studio, Will Oltman

OM8



Omena Bar Stool

	MODEL	LIST PRICE
Maple shell	OMBW-M	\$1357
W 17.5 D 21 H 31 SH 30		Optional Glides: Add \$8.00 net per chair for a set of four (4). Optional Glides raise chair height .5 inch.



Omena Bar Stool

	MODEL	LIST PRICE/ GRADE	COM/COL	A	B	C	D	E	F	G	H	I	J	K	L
Maple shell/base, upholstered seat	OMBWU-M	\$1483	1520	1539	1558	1577	1596	1615	1634	1653	1672	1691	1710	1729	
W 17.5 D 21 H 31 SH 30.5		Optional Glides: Add \$8.00 net per chair for a set of four (4). Optional Glides raise chair height .5 inch. COM yardage: 0.5 yards, 1-2 seats Contact Leland Customer Experience for yardage requirements on textiles with repeats. For COL requirements please contact Leland Customer Experience.													



Omena Bar Stool

	MODEL	LIST PRICE
Oak shell	OMBW-O	\$1520
W 17.5 D 21 H 31 SH 30		Optional Glides: Add \$8.00 net per chair for a set of four (4). Optional Glides raise chair height .5 inch.



Omena Bar Stool

	MODEL	LIST PRICE/ GRADE	COM/COL	A	B	C	D	E	F	G	H	I	J	K	L
Oak shell, upholstered seat	OMBWU-O	\$1646	1683	1702	1721	1740	1759	1778	1797	1816	1835	1854	1873	1892	
W 17.5 D 21 H 31 SH 30.5		Optional Glides: Add \$8.00 net per chair for a set of four (4). Optional Glides raise chair height .5 inch. COM yardage: 0.5 yards, 1-2 seats Contact Leland Customer Experience for yardage requirements on textiles with repeats. For COL requirements please contact Leland Customer Experience.													

To specify:
Please refer to pages 3-4 for complete specifying information.
Specify all products by their product code.

Pricing Effective: July 2021

OMENA BAR STOOL
Design: 2B Studio, Will Oltman

OM9



Omena Low Stool

MODEL

LIST PRICE

Maple shell

OMLW-M

\$1,104

W 16.5 D 12.09 H 19 SH 18

Optional Glides: Add \$8.00 net per chair for a set of four (4). Optional Glides raise chair height .5 inch.
Gradient Finishes Upcharge: \$168 List



Omena Low Stool

MODEL

LIST PRICE/
GRADE

COM/COL

A

B

C

D

E

F

G

H

I

J

K

L

Maple shell/base,
upholstered seat

OMLWU-M

\$1,211

1248

1267

1286

1305

1324

1343

1362

1381

1400

1419

1438

1457

W 17.83 D 13.53 H 19.35
SH 18.26

Optional Glides: Add \$8.00 net per chair for a set of four (4). Optional Glides raise chair height .5 inch.
Gradient Finishes Upcharge: \$168 List
COM yardage: 0.5 yards, 1-2 seats
Contact Leland Customer Experience for yardage requirements on textiles with repeats.
For COL requirements please contact Leland Customer Experience.



Omena Low Stool

MODEL

LIST PRICE

Oak shell

OMLW-O

\$1,242

W 16.5 D 12.09 H 19 SH 18

Optional Glides: Add \$8.00 net per chair for a set of four (4). Optional Glides raise chair height .5 inch.



Omena Low Stool

MODEL

LIST PRICE/
GRADE

COM/COL

A

B

C

D

E

F

G

H

I

J

K

L

Oak shell,
upholstered seat

OMLWU-O

\$1,350

1387

1406

1425

1444

1463

1482

1501

1520

1539

1558

1577

1596

W 17.83 D 13.53 H 19.35
SH 18.26

Optional Glides: Add \$8.00 net per chair for a set of four (4). Optional Glides raise chair height .5 inch.
COM yardage: 0.5 yards, 1-2 seats
Contact Leland Customer Experience for yardage requirements on textiles with repeats.
For COL requirements please contact Leland Customer Experience.

To specify:

Please refer to pages 3-4 for complete specifying information.
Specify all products by their product code.

Pricing Effective: July 2021

**5695 Eagle Drive, SE
Grand Rapids,
Michigan 49512
616-975-9260
lelandfurniture.com**

Parfait II

July 2021 Price List



Parfait II

Table of Contents	PII2
Specification Information	PII3
Specification Example	PII4
Stacking Side Chair	PII5
Non-Stacking Side Chair	PII6
Mobile Stacking Side Chair	PII7
Mobile Non-Stacking Side Chair	PII9
Arm Chair	PII11
Mobile Arm Chair	PII12
Counter Chair	PII14
Bar Chair	PII15
Transport/Stacking Dolly	PII16

Chair Model

STACKING SIDE CHAIR:

DESCRIPTION	CODE
upholstered seat, wood back	PSSUW
wood seat, wood back	PSSWW
upholstered seat, wood back, upholstered back onlay	PSSUWU

SIDE CHAIR:

DESCRIPTION	CODE
upholstered seat, wood back	PSUW
wood seat, wood back	PSWW
upholstered seat, wood back, upholstered back onlay	PSUWU

ARM CHAIR:

DESCRIPTION	CODE
upholstered seat, wood back, polypropylene arm cap	PAUW
wood seat, wood back, polypropylene arm cap	PAWW
upholstered seat, wood back	
upholstered back onlay, polypropylene arm cap	PAUWU-P
upholstered seat, wood back	
upholstered back onlay, upholstered arm cap	PAUWU-U

COUNTER CHAIR:

DESCRIPTION	CODE
upholstered seat, wood back	PCUW
wood seat, wood back	PCWW
upholstered seat, wood back, upholstered back onlay	PCUWU

BAR CHAIR:

DESCRIPTION	CODE
upholstered seat, wood back	PBUW
wood seat, wood back	PBWW
upholstered seat, wood seat, upholstered back onlay	PBUWU

MOBILE STACKING SIDE CHAIR:

DESCRIPTION	CODE
upholstered seat, wood back	PMSSUW
wood seat, wood back	PMSSWW
upholstered seat, wood back, upholstered back onlay	PMSSUWU

MOBILE SIDE CHAIR (NON-STACKING):

DESCRIPTION	CODE
upholstered seat, wood back	PMSUW
wood seat, wood back	PMSWW
upholstered seat, wood back	PMSUWU

MOBILE ARM CHAIR (NON-STACKING):

DESCRIPTION	CODE
upholstered seat, wood back, polypropylene arm cap	PMAUW
wood seat, wood back, polypropylene arm cap	PMAWW
upholstered seat, wood back,	
upholstered back onlay, polypropylene arm cap	PMAUWU-P
upholstered seat, wood back,	
upholstered back onlay, upholstered arm cap	PMAUWU-U

Upholstery Selection

Please refer to Leland Textile Program which features textiles and leathers from the following partners:

- Camira
- Green Hides
- Carnegie
- Maharam
- CF Stinson
- Unika Vaev

The complete grade list can be found on our website or you can specify COM/COL. Due to the design of this product, it is recommended that all non pre-approved textile be tested for compatibility.

Pricing Effective: July 2021

Seat and Back Wood Finish

STANDARD LELAND COLORS

CUSTOM SPECIFY Custom (01)

*Please note that Parfait II is NOT AVAILABLE in the following finishes:
Natural Walnut Matte (08M), Natural Beech (09), Natural White Oak Matte (12M)

Frame Finish

DESCRIPTION	CODE	DESCRIPTION	CODE
Sterling	ST	Matte Mercury	MMR
Warm Grey	WG	Matte Mineral	MMN
Cool Grey	CG	Matte Burnish	MBN
Black	B	Matte Foundry	MFN
Matte New Penny	MNP		
White	W		
Matte Gold Rush	MGR		
TEXTURED	CODE	TEXTURED	CODE
Soda Red Textured	SRT	Dolphin Textured	DLT
Oxford Textured	OXT T	angerine Textured	TNT
Ice Blue Textured	IBT	Artic Textured	ART
Caribbean Textured	CBT	Ink Textured	INT
Limelight Textured	LLT		

Arm Cap Type

DESCRIPTION	CODE
Polypropylene	P
Upholstered	U

Arm Cap Color (Polypropylene)

DESCRIPTION	CODE
Black	B
Silver	S

Glide Type or Caster Type for Mobile Chairs

STANDARD:

DESCRIPTION	CODE
Nylon	S

OPTIONAL:

DESCRIPTION	CODE
Felt	FC
Floor Saver™ (for VCT type floors)	FS
Metal	M
Rubber	R

Please note that optional glides raise the chair height .5 inch.

CASTER TYPE:

DESCRIPTION	CODE
Hard floor caster	HF
Soft floor caster	SF

Specifications required to create the product code

- Model
- Seat Upholstery or Finish
- Back Finish
- Upholstered Back Onlay (when applicable)
- Frame Finish
- Arm Cap Type (when applicable)
- Arm Cap Color or Upholstery (when applicable)
- Glide or Caster Type

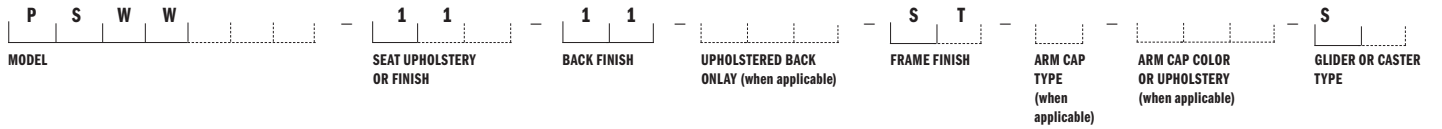

MODEL

Parfait II Side Chair -
wood seat, wood back (PSWW)

SEAT UPHOLSTERY OR FINISH

Natural (11)

BACK FINISH

Natural (11)

UPHOLSTERED BACK ONLAY

When applicable, enter upholstery grade, COM or COL



FRAME FINISH

Sterling (ST)

ARM CAP TYPE

When applicable, enter arm cap type code

ARM CAP COLOR OR UPHOLSTERY

When applicable, enter color, upholstery grade, COM or COL



PARFAIT II STACKING SIDE CHAIR
 Design: Bruce Sienkowski

PII5



Parfait II

Stacking Side Chair

	MODEL	LIST PRICE/GRADE	COM/COL	A	B	C	D	E	F	G	H	I	J	K	L
Upholstered seat, wood back	PSSUW		\$612	640	655	672	687	702	718	733	749	764	781	796	812

W 20.25 D 21.5 H 32.5 SH 19

Optional Glides: Add \$8.00 net per chair for a set of four (4). Optional Glides raise chair height .5 inch.
 COM Yardage: 1 or 2 seats: .75 yard; 3 or 4 seats: 1.5 yards; 5 or 6 seats: 2.25 yards
 Contact Leland Customer Experience for yardage requirements on textiles with repeats.
 For COL requirements please contact Leland Customer Experience.



Parfait II

Stacking Side Chair

	MODEL	LIST PRICE
Wood seat, wood back	PSSWW	\$640

W 20.25 D 21.5 H 32.5 SH 18.5

Optional Glides: Add \$8.00 net per chair for a set of four (4). Optional Glides raise chair height .5 inch.



Parfait II

Stacking Side Chair

	MODEL	LIST PRICE/GRADE	COM/COL	A	B	C	D	E	F	G	H	I	J	K	L
Upholstered seat, wood back upholstered seat and back	PSSUWU	\$689		732	755	777	799	822	844	866	888	911	933	955	977

W 20.25 D 21.5 H 32.5 SH 19

Optional Glides: Add \$8.00 net per chair for a set of four (4). Optional Glides raise chair height .5 inch.
 COM Yardage: 1 seat and back: .75 yard, 6 seats and backs: 3.5 yards
 Contact Leland Customer Experience for yardage requirements on textiles with repeats.
 For COL requirements please contact Leland Customer Experience.

To specify:
 Please refer to pages 3-5 for complete specifying information.
 Specify all products by their product code.

Pricing Effective: July 2021

PARFAIT II NON-STACKING SIDE CHAIR

Design: Bruce Sienkowski

PII6



Parfait II

Non-Stacking Side Chair

	MODEL	LIST PRICE/GRADE	COM/COL	A	B	C	D	E	F	G	H	I	J	K	L
Upholstered seat, wood back	PSUW		\$552	580	595	611	626	642	658	674	689	705	720	735	751

W 20.25 D 21.5 H 32.5 SH 19

Optional Glides: Add \$8.00 net per chair for a set of four (4). Optional Glides raise chair height .5 inch.
 COM Yardage: 1 or 2 seats: .75 yard; 3 or 4 seats: 1.5 yards; 5 or 6 seats: 2.25 yards
 Contact Leland Customer Experience for yardage requirements on textiles with repeats.
 For COL requirements please contact Leland Customer Experience.



Parfait II

Non-Stacking Side Chair

	MODEL	LIST PRICE
Wood seat, wood back	PSWW	\$583

W 20.5 D 21.5 H 32.5 SH 18.5

Optional Glides: Add \$8.00 net per chair for a set of four (4). Optional Glides raise chair height .5 inch.



Parfait II

Non-Stacking Side Chair

	MODEL	LIST PRICE/GRADE	COM/COL	A	B	C	D	E	F	G	H	I	J	K	L
Upholstered seat, wood back upholstered seat and back	PSUWU		\$647	690	713	734	757	779	801	824	846	868	891	913	935

W 20.5 D 21.5 H 32.5 SH 19

Optional Glides: Add \$8.00 net per chair for a set of four (4). Optional Glides raise chair height .5 inch.
 COM Yardage: 1 seat and back: .75 yard, 6 seats and backs: 3.5 yards
 Contact Leland Customer Experience for yardage requirements on textiles with repeats.
 For COL requirements please contact Leland Customer Experience.

To specify:

Please refer to pages 3-5 for complete specifying information.
 Specify all products by their product code.

Pricing Effective: July 2021

PARFAIT II MOBILE STACKING SIDE CHAIR

Design: Bruce Sienkowski

PII7

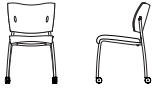

Parfait II Mobile Stacking Side Chair

	MODEL	LIST PRICE/GRADE	COM/COL	A	B	C	D	E	F	G	H	I	J	K	L
Upholstered seat, wood back hard floor caster	PMSSUW-HF		\$737	765	782	797	813	828	844	859	874	891	906	922	937

COM Yardage: 1 or 2 seats: .75 yard; 3 or 4 seats: 1.5 yards; 5 or 6 seats: 2.25 yards
 Contact Leland Customer Experience for yardage requirements on textiles with repeats.
 For COL requirements please contact Leland Customer Experience.

W 20.25 D 21.5 H 32.5 SH 19

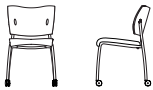

Parfait II Mobile Stacking Side Chair

	MODEL	LIST PRICE/ GRADE	COM/COL	A	B	C	D	E	F	G	H	I	J	K	L
Upholstered seat, wood back soft floor caster	PMSSUW-SF		\$737	765	782	797	813	828	844	859	874	891	906	922	937

COM Yardage: 1 or 2 seats: .75 yard; 3 or 4 seats: 1.5 yards; 5 or 6 seats: 2.25 yards
 Contact Leland Customer Experience for yardage requirements on textiles with repeats.
 For COL requirements please contact Leland Customer Experience.

W 20.5 D 21.5 H 32.5 SH 19

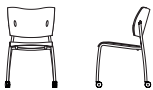

Parfait II Mobile Stacking Side Chair

	MODEL	LIST PRICE
Wood seat, wood back hard floor caster	PMSSWW-HF	\$774

W 20.5 D 21.5 H 32.5 SH 18.5



Parfait II Mobile Stacking Side Chair

	MODEL	LIST PRICE
Wood seat, wood back soft floor caster	PMSSWW-SF	\$774

W 20.5 D 21.5 H 32.5 SH 18.5

To specify:

Please refer to pages 3-5 for complete specifying information.
 Specify all products by their product code.

Pricing Effective: July 2021

PARFAIT II MOBILE STACKING SIDE CHAIR

Design: Bruce Sienkowski

PII8

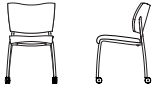

Parfait II Mobile Stacking Side Chair

	MODEL	LIST PRICE/GRADE	COM/COL	A	B	C	D	E	F	G	H	I	J	K	L
Upholstered seat, wood back upholstered back onlay, hard floor caster	PMSSUWU-HF		\$815	858	881	903	925	948	969	992	1015	1036	1059	1082	1103
W 20.25 D 21.5 H 32.5 SH 19															

COM Yardage: 1 seat and back: .75 yard, 6 seats and backs: 3.5 yard
Contact Leland Customer Experience for yardage requirements on textiles with repeats.
For COL requirements please contact Leland Customer Experience.

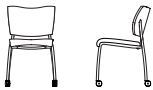

Parfait II Mobile Stacking Side Chair

	MODEL	LIST PRICE/GRADE	COM/COL	A	B	C	D	E	F	G	H	I	J	K	L
Upholstered seat, wood back upholstered back onlay, soft floor caster	PMSSUWU-SF		\$815	858	881	903	925	948	969	992	1015	1036	1059	1082	1103
W 20.25 D 21.5 H 32.5 SH 19															

COM Yardage: 1 seat and back: .75 yard, 6 seats and backs: 3.5 yard
Contact Leland Customer Experience for yardage requirements on textiles with repeats.
For COL requirements please contact Leland Customer Experience.

To specify:

Please refer to pages 3-5 for
complete specifying information.

Specify all products by their
product code.

Pricing Effective: July 2021

PARFAIT II MOBILE NON-STACKING SIDE CHAIR

Design: Bruce Sienkowski

PII9

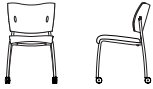

Parfait II Mobile

Non-Stacking Side Chair

	MODEL	LIST PRICE/GRADE	COM/COL	A	B	C	D	E	F	G	H	I	J	K	L
Upholstered seat, wood back, hard floor caster	PMSUW-HF		\$674	701	717	732	748	763	779	795	811	826	842	857	872

W 20.25 D 21.5 H 32.5 SH 19

COM Yardage: 1 or 2 seats: .75 yard; 3 or 4 seats: 1.5 yards; 5 or 6 seats: 2.25 yards
Contact Leland Customer Experience for yardage requirements on textiles with repeats.
For COL requirements please contact Leland Customer Experience.

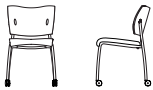

Parfait II Mobile

Non-Stacking Side Chair

	MODEL	LIST PRICE/ GRADE	COM/COL	A	B	C	D	E	F	G	H	I	J	K	L
Upholstered seat, wood back, soft floor caster	PMSUW-SF		\$674	701	717	732	748	763	779	795	811	826	842	857	872

W 20.5 D 21.5 H 32.5 SH 19

COM Yardage: 1 or 2 chair seats and back onlays: .75 yard; 3 or 4 chair seats and back onlays: 1.5 yards;
5 or 6 Chair seats and back onlays: 2.25 yards
Contact Leland Customer Experience for yardage requirements on textiles with repeats.
For COL requirements please contact Leland Customer Experience.

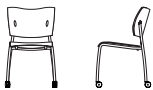

Parfait II Mobile

Non-Stacking Side Chair

	MODEL	LIST PRICE
Wood seat, wood back, hard floor caster	PMSWW-HF	\$710
W 20.5 D 21.5 H 32.5 SH 18.5		



Parfait II Mobile

Non-Stacking Side Chair

	MODEL	LIST PRICE
Wood seat, wood back soft floor caster	PMSSWW-SF	\$710
W 20.5 D 21.5 H 32.5 SH 18.5		

To specify:

Please refer to pages 3-5 for complete specifying information.
Specify all products by their product code.

Pricing Effective: July 2021

PARFAIT II MOBILE NON-STACKING SIDE CHAIR

Design: Bruce Sienkowski

PII10

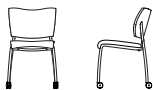

Parfait II Mobile

Non-Stacking Side Chair

	MODEL	LIST PRICE/GRADE	COM/COL	A	B	C	D	E	F	G	H	I	J	K	L
Upholstered seat, wood back upholstered back onlay, hard floor caster	PMSUWU-HF	\$774		817	839	861	884	906	928	951	973	995	1018	1040	1062
W 20.25 D 21.5 H 32.5 SH 19															

COM Yardage: 1 seat and back: .75 yard, 6 seats and backs: 3.5 yards
 Contact Leland Customer Experience for yardage requirements on textiles with repeats.
 For COL requirements please contact Leland Customer Experience.

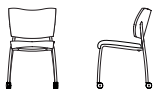

Parfait II Mobile

Non-Stacking Side Chair

	MODEL	LIST PRICE/GRADE	COM/COL	A	B	C	D	E	F	G	H	I	J	K	L
Upholstered seat, wood back upholstered back onlay, soft floor caster	PMSUWU-SF	\$774		817	839	861	884	906	928	951	973	995	1018	1040	1062
W 20.25 D 21.5 H 32.5 SH 19															

COM Yardage: 1 seat and back: .75 yard, 6 seats and backs: 3.5 yards
 Contact Leland Customer Experience for yardage requirements on textiles with repeats.
 For COL requirements please contact Leland Customer Experience.

To specify:

Please refer to pages 3-5 for complete specifying information.

Specify all products by their product code.

Pricing Effective: July 2021

PARFAIT II ARM CHAIR
Design: Bruce Sienkowski

PII11



Parfait II Arm Chair	MODEL	LIST PRICE/GRADE	COM/COL	A	B	C	D	E	F	G	H	I	J	K	L
Upholstered seat, wood back	PAUW	\$774		801	817	832	849	864	880	895	911	926	941	958	973

W 25.5 D 21.5 H 32.5
SH 19 AH 27

Optional Glides: Add \$8.00 net per chair for a set of four (4). Optional Glides raise chair height .5 inch.
COM Yardage: 1 or 2 seats: .75 yard; 3 or 4 seats: 1.5 yards; 5 or 6 seats: 2.25 yards
Contact Leland Customer Experience for yardage requirements on textiles with repeats.
For COL requirements please contact Leland Customer Experience.



Parfait II Arm Chair	MODEL	LIST PRICE
Wood seat, wood back	PAWW	\$801

W 25.5 D 21.5 H 32.5
SH 18.5 AH 18.5

Optional Glides: Add \$8.00 net per chair for a set of four (4). Optional Glides raise chair height .5 inch.



Parfait II Arm Chair	MODEL	LIST PRICE/GRADE	COM/COL	A	B	C	D	E	F	G	H	I	J	K	L
Upholstered seat, wood back Upholstered back onlay, polypropylene arm cap	PAUWU-P	\$832		877	898	921	942	965	988	1009	1032	1055	1076	1099	1121

W 25.5 D 21.5 H 32.5
SH 19 AH 27

Optional Glides: Add \$8.00 net per chair for a set of four (4). Optional Glides raise chair height .5 inch.
COM Yardage: 1 seat and back: .75 yard, 6 seats and backs: 3.5 yards
Contact Leland Customer Experience for yardage requirements on textiles with repeats.
For COL requirements please contact Leland Customer Experience.



Parfait II Arm Chair	MODEL	LIST PRICE/GRADE	COM/COL	A	B	C	D	E	F	G	H	I	J	K	L
Upholstered seat, wood back Upholstered back onlay, upholstered arm cap	PAUWU-U	\$878		921	942	965	988	1009	1032	1055	1076	1099	1121	1143	1166

W 25.5 D 21.5 H 32.5
SH 19 AH 27

Optional Glides: Add \$8.00 net per chair for a set of four (4). Optional Glides raise chair height .5 inch.
upholstered arm cap COM Yardage: 1 seat and back: .75 yard, 6 seats and backs: 3.5 yards,
1 or 2 pairs arm caps:.25 yard
Contact Leland Customer Experience for yardage requirements on textiles with repeats.
For COL requirements please contact Leland Customer Experience..

To specify:
Please refer to pages 3-5 for complete specifying information.
Specify all products by their product code.

Pricing Effective: July 2021

PARFAIT II MOBILE ARM CHAIR
Design: Bruce Sienkowski

PII12



Parfait II Mobile Arm Chair	MODEL	LIST PRICE/GRADE	COM/COL	A	B	C	D	E	F	G	H	I	J	K	L
Upholstered seat, wood back, polypropylene arm cap, hard floor caster	PMAUW-P-HF	\$967		1010	1033	1056	1077	1100	1123	1144	1167	1189	1211	1234	1256
W 25.5 D 21.5 H 32.5 SH 19 AH 27		COM Yardage: 1 or 2 seats: .75 yard; 3 or 4 seats: 1.5 yards; 5 or 6 seats: 2.25 yards Contact Leland Customer Experience for yardage requirements on textiles with repeats. For COL requirements please contact Leland Customer Experience.													



Parfait II Mobile Arm Chair	MODEL	LIST PRICE/GRADE	COM/COL	A	B	C	D	E	F	G	H	I	J	K	L
Upholstered seat, wood back, polypropylene arm cap, soft floor caster	PMAUW-P-SF	\$967		1010	1033	1056	1077	1100	1123	1144	1167	1189	1211	1234	1256
W 25.5 D 21.5 H 32.5 SH 19 AH 27		COM Yardage: 1 or 2 chair seats and back onlays: .75 yard; 3 or 4 chair seats and back onlays: 1.5 yards; 5 to 6 Chair seats and back onlays: 2.25 yards Contact Leland Customer Experience for yardage requirements on textiles with repeats. For COL requirements please contact Leland Customer Experience.													



Parfait II Mobile Arm Chair	MODEL	LIST PRICE
Wood seat, wood back, polypropylene arm cap, hard floor caster	PMAWW-P-HF	\$949
W 25.5 D 21.5 H 32.5 SH 18.5		



Parfait II Mobile Arm Chair	MODEL	LIST PRICE
Wood seat, wood back, polypropylene arm cap, soft floor caster	PMAWW-P-SF	\$949
W 25.5 D 21.5 H 32.5 SH 18.5		

To specify:
Please refer to pages 3-5 for complete specifying information.
Specify all products by their product code.

Pricing Effective: July 2021

PARFAIT II MOBILE ARM CHAIR

Design: Bruce Sienkowski

PII13



Parfait II Mobile Arm Chair

	MODEL	LIST PRICE/ GRADE	COM/COL	A	B	C	D	E	F	G	H	I	J	K	L
Upholstered seat, Upholstered back onlay, upholstered arm cap, hard floor caster	PMAUWU-U-HF		\$1012	1056	1077	1100	1123	1144	1167	1189	1211	1234	1256	1278	1301
W 25.5 D 21.5 H 32.5 SH 19 AH 27		COM Yardage: 1 seat and back: .75 yard, 6 seats and backs: 3.5 yards 2 pairs armcaps:.25 yard Contact Leland Customer Experience for yardage requirements on textiles with repeats. For COL requirements please contact Leland Customer Experience.													



Parfait II Mobile Arm Chair

	MODEL	LIST PRICE/ GRADE	COM/COL	A	B	C	D	E	F	G	H	I	J	K	L
Upholstered seat, Upholstered back onlay, upholstered arm cap, soft floor caster	PMAUWU-U-SF		\$1012	1056	1077	1100	1123	1144	1167	1189	1211	1234	1256	1278	1301
W 25.5 D 21.5 H 32.5 SH 19 AH 27		COM Yardage: 1 seat and back: .75 yard, 6 seats and backs: 3.5 yards 2 pairs armcaps:.25 yard Contact Leland Customer Experience for yardage requirements on textiles with repeats. For COL requirements please contact Leland Customer Experience.													



Parfait II Mobile Arm Chair

	MODEL	LIST PRICE/ GRADE	COM/COL	A	B	C	D	E	F	G	H	I	J	K	L
Upholstered seat, Upholstered back onlay, polypropylene arm cap, hard floor caster	PMAUWU-P-HF		\$967	1010	1033	1056	1077	1100	1123	1144	1167	1189	1211	1234	1256
W 25.5 D 21.5 H 32.5 SH 19 AH 27		COM Yardage: 1 seat and back: .75 yard, 6 seats and backs: 3.5 yards Contact Leland Customer Experience for yardage requirements on textiles with repeats. For COL requirements please contact Leland Customer Experience.													



Parfait II Mobile Arm Chair

	MODEL	LIST PRICE/ GRADE	COM/COL	A	B	C	D	E	F	G	H	I	J	K	L
Upholstered seat, Upholstered back onlay, polypropylene arm cap, soft floor caster	PMAUWU-P-SF		\$967	1010	1033	1056	1077	1100	1123	1144	1167	1189	1211	1234	1256
W 25.5 D 21.5 H 32.5 SH 19 AH 27		COM Yardage: 1 seat and back: .75 yard, 6 seats and backs: 3.5 yards Contact Leland Customer Experience for yardage requirements on textiles with repeats. For COL requirements please contact Leland Customer Experience.													

To specify:

Please refer to pages 3-5 for complete specifying information. Specify all products by their product code.

Pricing Effective: July 2021

PARFAIT II COUNTER CHAIR
 Design: Bruce Sienkowski

PII14



Parfait II Counter Chair	MODEL	LIST PRICE/GRADE	COM/COL	A	B	C	D	E	F	G	H	I	J	K	L
Upholstered seat, wood back	PCUW	\$767		795	811	826	842	857	872	888	904	920	935	951	966

W 19.5 D 24 H 39 SH 25.5

Optional Glides: Add \$8.00 net per chair for a set of four (4). Optional Glides raise chair height .5 inch.
 COM Yardage: 1 or 2 seats: .75 yard; 3 or 4 seats: 1.5 yards; 5 or 6 seats: 2.25 yards
 Contact Leland Customer Experience for yardage requirements on textiles with repeats.
 For COL requirements please contact Leland Customer Experience.



Parfait II Counter Chair	MODEL	LIST PRICE
Wood seat, wood back	PCWW	\$801

W 19.5 D 24 H 39 SH 25

Optional Glides: Add \$8.00 net per chair for a set of four (4). Optional Glides raise chair height .5 inch.



Parfait II Counter Chair	MODEL	LIST PRICE/GRADE	COM/COL	A	B	C	D	E	F	G	H	I	J	K	L
Upholstered seat, wood back upholstered back onlay	PCUWU	\$827		870	893	915	937	960	982	1004	1027	1049	1071	1093	1115

W 19.5 D 24 H 39 SH 25.5

Optional Glides: Add \$8.00 net per chair for a set of four (4). Optional Glides raise chair height .5 inch.
 COM Yardage: 1 seat and back: .75 yard, 6 seats and backs: 3.5 yards
 Contact Leland Customer Experience for yardage requirements on textiles with repeats.
 For COL requirements please contact Leland Customer Experience.

To specify:
 Please refer to pages 3-5 for complete specifying information.
 Specify all products by their product code.

Pricing Effective: July 2021

PARFAIT II BAR CHAIR
Design: Bruce Sienkowski

PII15

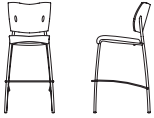

Parfait II Bar Chair

	MODEL	LIST PRICE/GRADE	COM/COL	A	B	C	D	E	F	G	H	I	J	K	L
Upholstered seat, wood back	PBUW	\$781		809	824	839	855	870	886	901	918	933	949	964	980

W 19.5 D 24 H 44 SH 31.5

Optional Glides: Add \$8.00 net per chair for a set of four (4). Optional Glides raise chair height .5 inch.
Yardage: 1 or 2 seats: .75 yard; 3 or 4 seats: 1.5 yards; 5 or 6 seats: 2.25 yards
Contact Leland Customer Experience for yardage requirements on textiles with repeats.
For COL requirements please contact Leland Customer Experience.

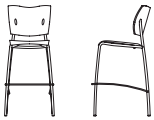

Parfait II Bar Chair

	MODEL	LIST PRICE
Wood seat, wood back	PBWW	\$817

W 19.5 D 24.5 H 44 SH 31

Optional Glides: Add \$8.00 net per chair for a set of four (4). Optional Glides raise chair height .5 inch.



Parfait II Bar Chair

	MODEL	LIST PRICE/GRADE	COM/COL	A	B	C	D	E	F	G	H	I	J	K	L
Upholstered seat, wood back, upholstered back onlay	PBUWU	\$838		882	904	926	949	970	993	1016	1037	1060	1083	1104	1127

W 19.5 D 24 H 44 SH 31.5

Optional Glides: Add \$8.00 net per chair for a set of four (4). Optional Glides raise chair height .5 inch.
COM Yardage: 1 seat and back: .75 yard, 6 seats and backs: 3.5 yards
Contact Leland Customer Experience for yardage requirements on textiles with repeats.
For COL requirements please contact Leland Customer Experience.

To specify:
Please refer to pages 3-5 for complete specifying information.
Specify all products by their product code.

Pricing Effective: July 2021

PARFAIT II TRANSPORT/STACKING DOLLY
Design: Bruce Sienkowski

PII16

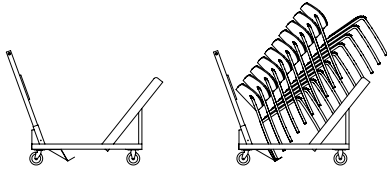

**Parfait II Transport/
Stacking Dolly**

MODEL

LIST PRICE

PSSD

Black Finish

\$883

W 25 D 57 H 44 (empty)

With 10 stacking chairs:

W 25 D 68 H 63

Parfait II Transport/Stacking Dolly handles up to 10 Parfait II stacking side chairs.

Please note that only the stacking version of the side chair will stack on the floor or Transport/Stacking Dolly.

To specify:

Please refer to pages 3-5 for
complete specifying information.

Specify all products by their
product code.

Pricing Effective: July 2021

**5695 Eagle Drive, SE
Grand Rapids,
Michigan 49512
616-975-9260
lelandfurniture.com**

Pluto

July 2021 Price List



Pluto

Table of Contents	PB2
Specification Information	PB3
Specification Example	PB4
Bench	PB5
Auxiliary Option	PB6

Bench Model

DESCRIPTION	CODE
Pluto	PT

Upholstery Selection

Please refer to Leland Textile Program which features textiles from the following partners:

- Camira
- Carnegie
- CF Stinson
- Green Hides
- Maharam
- Unika Vaev

The complete grade list can be found on our website or you can specify COM/COL. Due to the design of this product, it is recommended that all non pre-approved textile be tested for compatibility.

Upholstery Requirements

With a choice of textile combinations, Pluto encourages design creativity. Please note that requirements vary by combination. The graded price of the combined yardage will be calculated using the highest grade textile selected.

TEXTILE REQUIREMENTS	YARDAGE
One textile, entire bench:	3.25 yards
Two/Three textile combination	
Seat:	1 yard
Top:	1 yard
Side:	1.25 yards

Plinth Finish: Powdercoat and Chrome

DESCRIPTION	CODE
Sterling	ST
Warm Grey	WG
Cool Grey	CG
Black	B
White	W
Matte Gold Rush	MGR
Matte Mercury	MMR
Matte Mineral	MMN
Matte Burnish	MBN
Matte Foundry	MFN
Matte New Penny	MNP
Brushed Chrome	BC

Auxiliary Options

Floor mount must be specified at the time of the bench order.

DESCRIPTION	CODE
Floor mount	PTFM

Glides

Pluto glides are poly.

Shipment Detail

200 pounds of weight ballast is shipped separately from the Pluto bench and is required to be installed at the final delivery location.

Specifications required to create the product code

- Model
- Seat Upholstery
- Top Upholstery
- Side Upholstery
- Plinth Finish
- Floor Mount (when applicable)

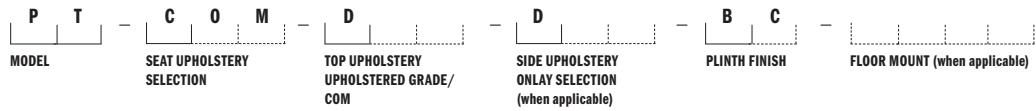

MODEL

Pluto (PT)

SEAT UPHOLSTERY

COM (COM)

TOP UPHOLSTERY

Grade D (D)

SIDE UPHOLSTERY

Grade D (D)

PLINTH FINISH

Brushed Chrome (BC)

FLOOR MOUNT

When applicable, enter Pluto Floor Mount Code



PLUTO BENCH
Design: Simon Pengelly

PB5

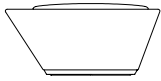

Pluto Bench	MODEL	LIST PRICE/ GRADE	COM/COL	A	B	C	D	E	F	G	H	I	J	K	L	
Powder coat plinth	PT-__	Powder Coat	\$1420	1610	1705	1801	1896	1991	2086	2182	2277	2373	2469	2563	2659	
W 34 D 37.75 H 16		COM REQUIREMENTS VARY BY COMBINATION SELECTED.														
		TEXTILE REQUIREMENTS:						YARDAGE								
		One textile, entire bench:						3.25 yards								
		Two/Three textile combination														
		Seat:			1 yard											
		Top:			1 yard											
		Side:			1.25 yards											

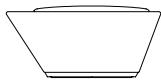

Pluto Bench	MODEL	LIST PRICE/ GRADE	COM/COL	A	B	C	D	E	F	G	H	I	J	K	L	
Brushed chrome plinth	PT-BC	Powder Coat	\$1566	1755	1850	1946	2041	2137	2232	2327	2422	2518	2613	2709	2805	
W 34 D 37.75 H 16		COM REQUIREMENTS VARY BY COMBINATION SELECTED.														
		TEXTILE REQUIREMENTS:						YARDAGE								
		One textile, entire bench:						3.25 yards								
		Two/Three textile combination														
		Seat:			1 yard											
		Top:			1 yard											
		Side:			1.25 yards											

To specify:
Please refer to pages 3-4 for complete specifying information.
Specify all products by their product code.

Pricing Effective: July 2021

PLUTO BENCH AUXILIARY OPTION

Design: Simon Pengelly

PB6

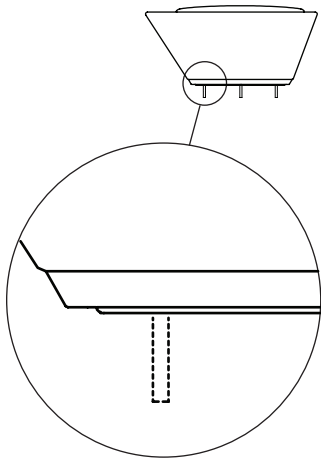

Pluto Floor Mount	MODEL	FRAME FINISH	LIST PRICE
	PTFM	Powder Coat	\$145

Due to the variety of floor surfaces on which the Pluto Bench may be installed, floor mount fasteners are not supplied by Leland International. The Pluto Bench floor mount feature consists of three .5" thru holes designed to use .3125" or .375" threaded studs. Leland International recommends at least 2" of exposed thread length from the floor surface.

Responsibility of fastener choice is the customers.

Floor Mount must be specified at the time of purchasing.

The Floor Mount cannot be added later in the field.

To specify:

Please refer to pages 3-4 for complete specifying information.

Specify all products by their product code.

Pricing Effective: July 2021

**5695 Eagle Drive, SE
Grand Rapids,
Michigan 49512
616-975-9260
lelandfurniture.com**

Quarry

July 2021 Price List



Quarry

Table of Contents	QR2
Bench Specification Information	QR3
Bench Specification Example	QR4
Benches	QR5
Collaborative Work Tools Specification Information	QR6
Collaborative Work Tools Specification Example	QR7
Collaborative Work Tools	QR8
Quarry Groupings	QR9

Bench Model

DESCRIPTION	CODE
Flint	QF
Mica	QM
Shale	QS
Quartz	QQ

Upholstery Selection

Please refer to Leland Textile Program which features textiles and leathers from the following partners:

- Camira
- Carnegie
- CF Stinson
- Green Hides
- Maharam
- Unika Vaev

The complete grade list can be found at www.lelandfurniture.com/ecatalog or you can specify COM/COL. Due to the design of this product, it is recommended that all non pre-approved textile be tested for compatibility.

Stitching Detail

DESCRIPTION	CODE
Basic (Recommended for patterned textiles)	B
Premium (Standard stitch on Quarry Benches)	P

Glide Selection

STANDARD GLIDES:

DESCRIPTION	CODE
Poly	P

OPTIONAL GLIDES:

DESCRIPTION	CODE
Felt	F

Auxiliary Options

DESCRIPTION	CODE
Weight Ballast (50 lbs.)	WB

Plinth Finish

All plinths are stainless steel.

Specifications required to create the product code

- Model
- Upholstery Selection
- Stitching Detail
- Glide Selection
- Auxiliary Option (when applicable)



MODEL

Quarry Flint (QF)

UPHOLSTERY SELECTION

Enter upholstery grade or COM.
Grade D (D)

STITCHING DETAIL

Premium (P)

GLIDE SELECTION

Poly (P)

AUXILIARY OPTION

When applicable



QUARRY BENCHES
Design: Bruce Sienkowski

QR5



Flint	MODEL	LIST PRICE/GRADE	COM/COL	A	B	C	D	E	F	G	H	I	J	K	L
W 19 D 18 H 19	QF	\$1092		1189	1237	1286	1335	1384	1432	1482	1530	1579	1628	1677	1725

Optional Glides: Add \$8.00 net per bench for a set of four (4). Optional Glides raise bench height .5 inch.
 Contrasting Stitch: Add \$25 net per bench - specify black (-CSB) or white thread (-CSW)
 COM Yardage: 1.25 yards
 Contact Leland Customer Experience for yardage requirements on textiles with repeats.



Mica	MODEL	LIST PRICE/GRADE	COM/COL	A	B	C	D	E	F	G	H	I	J	K	L
W 19 D 20 H 19	QM	\$1092		1189	1237	1286	1335	1384	1432	1482	1530	1579	1628	1677	1725

Optional Glides: Add \$8.00 net per bench for a set of four (4). Optional Glides raise bench height .5 inch.
 Contrasting Stitch: Add \$25 net per bench - specify black (-CSB) or white thread (-CSW)
 COM Yardage: 1.25 yards
 Contact Leland Customer Experience for yardage requirements on textiles with repeats.

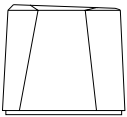

Shale	MODEL	LIST PRICE/GRADE	COM/COL	A	B	C	D	E	F	G	H	I	J	K	L
W 22 D 28.5 H 25.25	QS	\$1201		1334	1400	1466	1532	1598	1664	1730	1797	1863	1929	1995	2061

Optional Glides: Add \$8.00 net per bench for a set of four (4). Optional Glides raise bench height .5 inch.
 Contrasting Stitch: Add \$25 net per bench - specify black (-CSB) or white thread (-CSW)
 COM Yardage: 2.25 yards
 Contact Leland Customer Experience for yardage requirements on textiles with repeats.

Quartz	MODEL	LIST PRICE/GRADE	COM/COL	A	B	C	D	E	F	G	H	I	J	K	L
W 28.5 D 26 H 16.5	QQ	\$1201		1294	1340	1386	1432	1478	1525	1571	1618	1664	1710	1757	1803

Optional Glides: Add \$8.00 net per bench for a set of four (4). Optional Glides raise bench height .5 inch.
 Contrasting Stitch: Add \$25 net per bench - specify black (-CSB) or white thread (-CSW)
 COM Yardage: 1.75 yards
 Contact Leland Customer Experience for yardage requirements on textiles with repeats.

Weight Ballast	MODEL	LIST PRICE
50 lbs.	WB	\$71

To specify:
 Please refer to pages 3-4 for complete specifying information.
 Specify all products by their product code.

Pricing Effective: July 2021

Collaborative Work Space Model

DESCRIPTION	CODE
Flint bench with tablet	QFT
Mobile tablet stand	QMT
Power module	QPM

Tablet Support or Mobile Tablet Column Finish

DESCRIPTION	CODE
White	W
Sterling	ST
Black	B

Upholstery Selection

Please refer to Leland Textile Program which features textiles and leathers from the following partners:

- Camira
- Green Hides
- Carnegie
- Maharam
- CF Stinson
- Unika Vaev

The complete grade list can be found on our website or you can specify COM/COL. Due to the design of this product, it is recommended that all non pre-approved textile be tested for compatibility.

Stitching Detail

DESCRIPTION	CODE
Basic (Recommended for patterned textiles)	B
Premium (Standard stitch on Quarry Benches)	P

Top Surface

DESCRIPTION	CODE
Corian®	C
Wood	V
Laminate	L

Top Surface Finish or Color

CORIAN® TOPS:

DESCRIPTION	CODE
Black Corian®	CB
White Corian®	CW
Grey Corian®	CG

WOOD TOPS:

STANDARD LELAND COLORS

*Natural Finish specify Natural 11

**Custom Finish specify Custom 01

LAMINATE TOPS:

DESCRIPTION	CODE
Black Laminate	LBK
White Laminate	LWH
Grey Laminate	LG

Note that Collaborative Work Tool edges are finished to match for wood tops and Natural 11 for laminate tops.

Glide Selection

STANDARD:

DESCRIPTION	CODE
Poly	P

OPTIONAL:

DESCRIPTION	CODE
Felt	F

Power Options

DESCRIPTION	CODE
1 Power Unit, three (3) 120v AC receptacles with 7'6" cord	3P
1 Power Unit, four (4) 120v AC receptacles, one (1) USB simplex charger with 7'6" cord	4P

Freight Note

Due to the size and nature of Quarry Collaborative Work Tools, the Freight Program does not apply to this product. Please contact Customer Experience for a quote.

Specifications required to create the product code

- Model
- Tablet Support or Mobile Tablet Stand Column Finish (when applicable)
- Upholstery Selection (when applicable)
- Stitching Detail (when applicable)
- Top Surface
- Top Surface Finish or Color
- Glide Selection
- Power Options (when applicable)



MODEL

Quarry Mobile Tablet Stand (QMT)

**TABLET SUPPORT OR MOBILE
STAND COLUMN FINISH**

White (W)

UPHOLSTERY SELECTION

When applicable, enter upholstery
grade or COM

STITCHING DETAIL

When applicable

TOP SURFACE

Corian® (C)

TOP SURFACE FINISH OR COLOR

Grey Corian® (CG)

GLIDE SELECTION

When applicable

POWER OPTIONS

When applicable



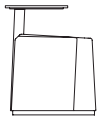

Flint Bench with Tablet				MODEL	LIST PRICE/ GRADE	COM/COL	A	B	C	D	E	F	G	H	I	J	K	L
W 25.6	D 21.5	H 25.5	SH 19	QFT	Corian®	\$2153	2251	2302	2351	2401	2451	2501	2552	2601	2651	2701	2751	2800
					Wood	\$2098	2197	2247	2296	2347	2396	2447	2497	2546	2597	2646	2696	2747
					Laminate	\$2045	2144	2195	2245	2294	2345	2394	2444	2494	2544	2595	2644	2694

Optional Glides: Add \$8.00 net per bench for a set of four (4). Optional Glides raise bench height .5 inch.
COM Yardage: 1.75 yards
Contact Leland Customer Experience for yardage requirements on textiles with repeats.

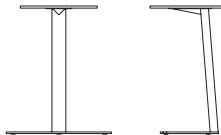

Mobile Tablet Stand			MODEL	FRAME FINISH	LIST PRICE
W 24.7	D 17	H 26	QMT	Corian®	\$1183
				Wood	\$1094
				Laminate	\$1043

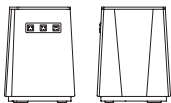

Power Module				MODEL	LIST PRICE/ GRADE	COM/COL	A	B	C	D	E	F	G	H	I	J	K	L
W 16.5	D 17.25	H 22.4		QPM - _ P	Corian®	\$2438	2538	2587	2638	2687	2737	2788	2837	2888	2937	2987	3037	3087
three (3) AC receptacles with 7'6" power cord or four (4) AC receptacles, one (1) USB simplex charger, with 7'6" power cord					Wood	\$2376	2475	2525	2575	2625	2674	2725	2775	2825	2875	2924	2975	3025
					Laminate	\$2326	2426	2475	2525	2575	2625	2674	2725	2775	2825	2875	2924	2975

Optional Glides: Add \$8.00 net per bench for a set of four (4). Optional Glides raise bench height .5 inch.
one (1) USB simplex charger , COM Yardage: 1.5 yards
with 7'6" power cord Contact Leland Customer Experience for yardage requirements on textiles with repeats.

To specify:
Please refer to pages 6-7 for complete specifying information.
Specify all products by their product code.

QUARRY BENCH GROUPINGS

Design: Bruce Sienkowski

QR9

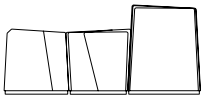
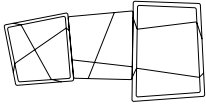

Example A

BENCHES

TOTAL COM LIST PRICE

Flint (QF)

\$3383

Mica (QM)

Shale (QS)

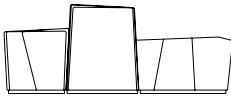
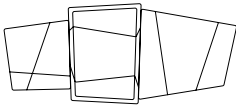

Example B

BENCHES

TOTAL COM LIST PRICE

Mica (QM)

\$3491

Shale (QS)

Quartz (QQ)

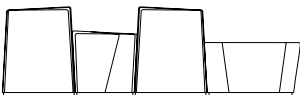
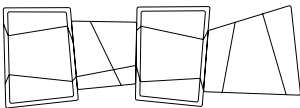

Example C

BENCHES

TOTAL COM LIST PRICE

Shale (QS)

\$4691

Mica (QM)

Shale (QS)

Quartz (QQ)

Please note that example groups are provided as a specification tool. Example groups are shown from top and side profiles. Quarry benches must be ordered as separate line items for each unique model and/or finish specification.

To specify:

Please refer to pages 3-4 for complete specifying information.

Specify all products by their product code.

QUARRY BENCH GROUPINGS

Design: Bruce Sienkowski

QR10

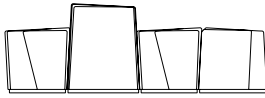
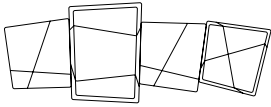

Example D

BENCHES

TOTAL COM LIST PRICE

Mica (QM)

\$4475

Shale (QS)

Mica (QM)

Flint (QF)

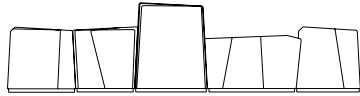
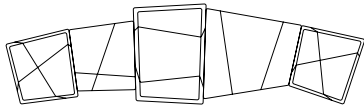

Example E

BENCHES

TOTAL COM LIST PRICE

Flint (QF)

\$5674

Mica (QM)

Shale (QS)

Quartz (QQ)

Flint (QF)

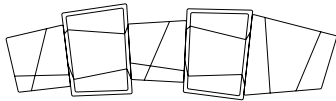

Example F

BENCHES

TOTAL COM LIST PRICE

Mica (QM)

\$5781

Shale (QS)

Mica (QM)

Shale (QS)

Quartz (QQ)

Please note that example groups are provided as a specification tool. Example groups are shown from top and side profiles. Quarry benches must be ordered as separate line items for each unique model and/or finish specification.

To specify:

Please refer to pages 3-4 for complete specifying information.

Specify all products by their product code.

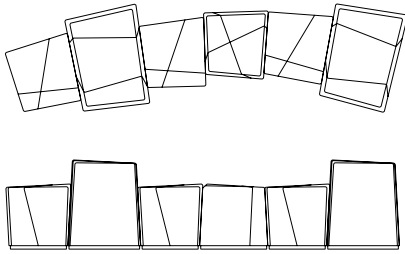

Example G	BENCHES	TOTAL COM LIST PRICE
	Mica (QM)	\$6764
	Shale (QS)	
	Mica (QM)	
	Flint (QF)	
	Mica (QM)	
	Shale (QS)	

Please note that example groups are provided as a specification tool. Example groups are shown from top and side profiles. Quarry benches must be ordered as separate line items for each unique model and/or finish specification.

To specify:
 Please refer to pages 3-4 for complete specifying information.
 Specify all products by their product code.

**5695 Eagle Drive, SE
Grand Rapids,
Michigan 49512
616-975-9260
lelandfurniture.com**

Rapson Forty-Eight

July 2021 Price List



Rapson Forty-Eight Chair

Table of Contents	RP48-C2
Specification Information	RP48-C3
Specification Example	RP48-C4
Four Leg Steel Frame Side Chair	RP48-C5
Four Leg Maple Frame Side Chair	RP48-C7
Four Leg Steel Frame Counter Chair	RP48-C9
Four Leg Maple Frame Counter Chair	RP48-C11
Four Leg Steel Frame Bar Chair	RP48-C13
Four Leg Maple Frame Bar Chair	RP48-C15

RAPSON FORTY-EIGHT CHAIR SPECIFICATION INFORMATION

RP48-C3

Chair Model

DESCRIPTION	CODE
Rapson Forty-Eight Four Leg Steel Frame Side Chair	RP48-SS
Rapson Forty-Eight Four Leg Maple Frame Side Chair	RP48-MS
Rapson Forty-Eight Four Leg Steel Frame Counter Chair	RP48-SC
Rapson Forty-Eight Four Leg Maple Frame Counter Chair	RP48-MC
Rapson Forty-Eight Four Leg Steel Frame Bar Chair	RP48-SB
Rapson Forty-Eight Four Leg Maple Frame Bar Chair	RP48-MB

Shell Options

DESCRIPTION	CODE
Standard Shell	MP
Standard Shell with Upholstered Seat Pad	MPU
Standard HPL Shell	H
Standard HPL Shell with Upholstered Seat Pad	HU
Fully Upholstered	FU
Walnut Shell	W
Walnut Shell with Upholstered Seat Pad	WU
Premium HPL Shell	P
Premium HPL Shell with Upholstered Seat Pad	PU

Shell Finishes

STANDARD HPL

(HIGH PRESSURE LAMINATE)

DESCRIPTION	CODE
Fiji	FI
Brittany Blue	BB
Moss Grey	MG
Navaho Red	NR
Fresh Papaya	FP
Forsythia	FS
Kool Kiwi	KK
Honey Plantain	HP
Spicy Flavors	SF
Cafe Sienna	CS
Designer White	WL
Platinum	PL

PREMIUM HPL

(HIGH PRESSURE LAMINATE)

DESCRIPTION	CODE
Blueberry Tart	BT
Oxidized Silver	OS
Chili Powder	CP
Marmalade	MM
Copper Alloy	CA

VENEER

STANDARD LELAND COLORS (On maple veneer shell only)

DESCRIPTION	CODE
Walnut	W
Maple	MP

Frame Finish Options

POWDERCOAT

(FOUR LEG STEEL TUBE)

DESCRIPTION	CODE	DESCRIPTION	CODE
Black	B	Matte New Penny	MNP
Cool Grey	CG	Sterling	ST
Matte Burnish	MBN	Warm Grey	WG
Matte Foundry	MFN	White	W
Matte Gold Rush	MGR	Black Textured	BT

Frame Finish Options (cont)

Matte Mercury	MMR	Grey Textured	GT
Matte Mineral	MMN	White Textured	WT

TEXTURED POWDERCOAT

(FOUR LEG STEEL TUBE)

DESCRIPTION	CODE
Black	BT
Grey	GT
White	WT

WOOD

(FOUR LEG WOOD FRAME, ON MAPLE)

DESCRIPTION	CODE
LELAND COLORS (Click to view)	

Upholstery Option

Please refer to Leland Textile Program which features textiles and leathers from the following partners:

- Camira
- Green Hides
- Carnegie
- Maharam
- CF Stinson
- Unika Vaev

The complete grade list can be found at lelandinternational.com/ecatalog or you can specify COM/COL. Due to the design of this product, it is recommended that all non pre-approved textile be tested for compatibility.

Glide Option

DESCRIPTION	CODE
Nylon (standard)	S
Felt	FC
Floor Saver *only available on metal base	FS
Metal *only available on metal base	M
Rubber *only available on metal base	R

Auxiliary Options

PAINTED GRAPHIC BACK

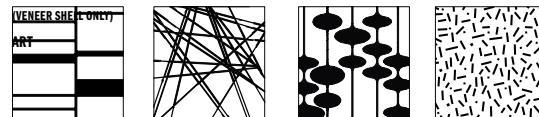

DESCRIPTION	CODE
Riff	RF
Improve	IM
Bebop	BB
Scat	SC

PAINTED GRAPHIC COLOR OPTIONS

DESCRIPTION	CODE	DESCRIPTION	CODE
Oxford II	49M	Putty	44M
Dolphin II	50M	Oyster	45M

Only available on veneer shells finished in a clear finish (Natural Walnut 08, Natural Walnut 08M, Natural Maple 11, or Natural Maple 11M).

SHELL HANDHOLD

DESCRIPTION	CODE
Handhold	HH

Specifications required to create the product code

- Model
- Shell Selection
- Shell Finish/Color
- Upholstered Onlay Selection (when applicable)
- Frame Finish (or foot ring where applicable)
- Glide Type

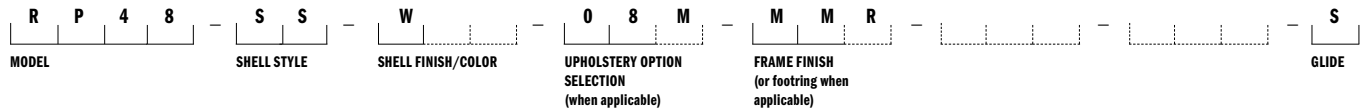

MODEL

Rapson Forty-Eight Side Chair (RP48-SS)

SHELL STYLE

Natural Maple (11)

FRAME FINISH

Sterling (ST)

UPHOLSTERY OPTION

Enter upholstery grade or COM (when applicable)

GLIDE OPTION

Nylon (S)



RAPSON FORTY-EIGHT FOUR LEG STEEL FRAME
SIDE CHAIR Design: Ralph Rapson

RP48-C5



**Rapson Forty-Eight
Steel Frame Side Chair**

	MODEL	LIST PRICE
Standard HPL Shell	RP48-SS-H	\$557
W 22 D 22.5 H 31.75 SH 18	Optional Glides: Add \$8.00 net per chair for a set of four (4)	



**Rapson Forty-Eight
Steel Frame Side Chair**

	MODEL	COM/COL	A	B	C	D	E	F	G	H	I	J	K	L
Standard HPL Shell, upholstered seat pad	RP48-SS-HU	\$624	664	685	705	724	745	764	785	804	825	845	865	885
W 22 D 22.5 H 31.75 SH 18	COM Yardage: 1 or 2 chairs: 1 yard Contact Leland Customer Experience for yardage requirements on textiles with repeats. For COL requirements please contact Leland Customer Experience. Optional Glides: Add \$8.00 net per chair for a set of four (4)													



**Rapson Forty-Eight
Steel Frame Side Chair**

	MODEL	COM/COL	A	B	C	D	E	F	G	H	I	J	K	L
Fully Upholstered	RP48-SS-FU	\$658	737	778	818	858	898	938	979	1019	1059	1099	1139	1179
W 22 D 22.5 H 31.75 SH 18	COM Yardage: 1.5 yards Contact Leland Customer Experience for yardage requirements on textiles with repeats. For COL requirements please contact Leland Customer Experience. Optional Glides: Add \$8.00 net per chair for a set of four (4)													



**Rapson Forty-Eight
Steel Frame Side Chair**

	MODEL	LIST PRICE
Standard Shell	RP48-MP	\$574
W 22 D 22.5 H 31.75 SH 18	Optional Glides: Add \$8.00 net per chair for a set of four (4)	



**Rapson Forty-Eight
Steel Frame Side Chair**

	MODEL	COM/COL	A	B	C	D	E	F	G	H	I	J	K	L
Standard Shell, upholstered seat pad	RP48-SS-MPU	\$641	681	701	721	742	761	782	801	822	842	861	882	901
W 22 D 22.5 H 31.75 SH 18	COM Yardage: 1 or 2 chairs: 1 yard Contact Leland Customer Experience for yardage requirements on textiles with repeats. For COL requirements please contact Leland Customer Experience. Optional Glides: Add \$8.00 net per chair for a set of four (4)													

**To specify:
Please refer to pages 3-4 for
complete specifying information.
Specify all products by their
product code.**

RAPSON FORTY-EIGHT FOUR LEG STEEL FRAME
SIDE CHAIR Design: Ralph Rapson

RP48-C6



**Rapson Forty-Eight
Steel Frame Side Chair**

	MODEL	LIST PRICE
Walnut Shell	RP48-SS-W	\$591
W 22 D 22.5 H 31.75 SH 18	Optional Glides: Add \$8.00 net per chair for a set of four (4)	



**Rapson Forty-Eight
Steel Frame Side Chair**

	MODEL	COM/COL	A	B	C	D	E	F	G	H	I	J	K	L
Walnut Shell, upholstered seat pad	RP48-SS-WU	\$658	698	718	737	758	778	798	818	838	858	879	898	919
W 22 D 22.5 H 31.75 SH 18	COM Yardage: 1 or 2 chairs: 1 yard Contact Leland Customer Experience for yardage requirements on textiles with repeats. For COL requirements please contact Leland Customer Experience. Optional Glides: Add \$8.00 net per chair for a set of four (4)													



**Rapson Forty-Eight
Steel Frame Side Chair**

	MODEL	LIST PRICE
Premium HPL Shell	RP48-SS-P	\$729
W 22 D 22.5 H 31.75 SH 18	Optional Glides: Add \$8.00 net per chair for a set of four (4)	



**Rapson Forty-Eight
Steel Frame Side Chair**

	MODEL	COM/COL	A	B	C	D	E	F	G	H	I	J	K	L
Premium HPL Shell, upholstered seat pad	RP48-SS-PU	\$796	836	856	877	896	916	936	956	976	996	1017	1036	1057
W 22 D 22.5 H 31.75 SH 18	COM Yardage: 1 or 2 chairs: 1 yard Contact Leland Customer Experience for yardage requirements on textiles with repeats. For COL requirements please contact Leland Customer Experience. Optional Glides: Add \$8.00 net per chair for a set of four (4)													

To specify:
 Please refer to pages 3-4 for
 complete specifying information.
 Specify all products by their
 product code.

Pricing Effective: July 2021

RAPSON FORTY-EIGHT MAPLE FRAME
SIDE CHAIR Design: Ralph Rapson

RP48-C7

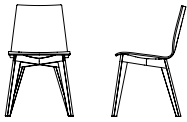

**Rapson Forty-Eight
Maple Frame Side Chair**

	MODEL	LIST PRICE
Standard HPL Shell	RP48-MS-H	\$787
W 19.5 D 21.25 H 32 SH 18.25		Optional Glides: Add \$8.00 net per chair for a set of four (4)

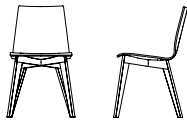

**Rapson Forty-Eight
Maple Frame Side Chair**

	MODEL	COM/COL	A	B	C	D	E	F	G	H	I	J	K	L
Standard HPL Shell, upholstered seat pad	RP48-MS-HU	\$854	894	914	934	954	974	994	1015	1034	1055	1074	1095	1114
W 19.5 D 21.25 H 32 SH 18.25		COM Yardage: 1 or 2 chairs: 1 yard Contact Leland Customer Experience for yardage requirements on textiles with repeats. For COL requirements please contact Leland Customer Experience. Optional Glides: Add \$8.00 net per chair for a set of four (4)												

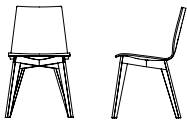

**Rapson Forty-Eight
Maple Frame Side Chair**

	MODEL	COM/COL	A	B	C	D	E	F	G	H	I	J	K	L
Fully Upholstered	RP48-MS-FU	\$887	967	1007	1048	1088	1128	1168	1208	1248	1289	1329	1369	1409
W 19.5 D 21.25 H 32 SH 18.25		COM Yardage: 1.5 yards Contact Leland Customer Experience for yardage requirements on textiles with repeats. For COL requirements please contact Leland Customer Experience. Optional Glides: Add \$8.00 net per chair for a set of four (4)												

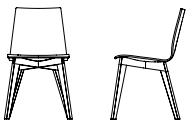

**Rapson Forty-Eight
Maple Frame Side Chair**

	MODEL	LIST PRICE
Standard Shell	RP48-MS-MP	\$803
W 19.5 D 21.25 H 32 SH 18.25		Optional Glides: Add \$8.00 net per chair for a set of four (4)

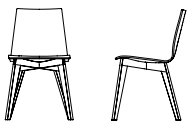

**Rapson Forty-Eight
Maple Frame Side Chair**

	MODEL	COM/COL	A	B	C	D	E	F	G	H	I	J	K	L
Standard Shell, upholstered seat pad	RP48-MS-MPU	\$870	911	931	951	970	991	1010	1031	1051	1071	1091	1111	1131
W 19.5 D 21.25 H 32 SH 18.25		COM Yardage: 1 or 2 chairs: 1 yard Contact Leland Customer Experience for yardage requirements on textiles with repeats. For COL requirements please contact Leland Customer Experience. Optional Glides: Add \$8.00 net per chair for a set of four (4)												

To specify:
Please refer to pages 3-4 for complete specifying information.
Specify all products by their product code.

Pricing Effective: July 2021

RAPSON FORTY-EIGHT MAPLE FRAME
SIDE CHAIR Design: Ralph Rapson

RP48-C8

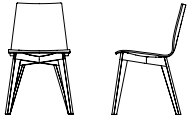

**Rapson Forty-Eight
Maple Frame Side Chair**

	MODEL	LIST PRICE
Walnut Shell	RP48-MS-W	\$820
W 19.5 D 21.5 H 32 SH 18.25	Optional Glides: Add \$8.00 net per chair for a set of four (4)	

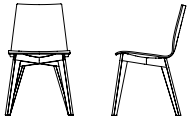

**Rapson Forty-Eight
Maple Frame Side Chair**

	MODEL	COM/COL	A	B	C	D	E	F	G	H	I	J	K	L
Walnut Shell, upholstered seat pad	RP48-MS-WU	\$887	927	948	967	988	1007	1028	1048	1068	1088	1108	1128	1147
W 19.5 D 21.5 H 32 SH 18.25	COM Yardage: 1 or 2 chairs: 1 yard Contact Leland Customer Experience for yardage requirements on textiles with repeats. For COL requirements please contact Leland Customer Experience. Optional Glides: Add \$8.00 net per chair for a set of four (4)													

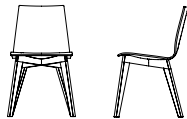

**Rapson Forty-Eight
Maple Frame Side Chair**

	MODEL	LIST PRICE
Premium HPL Shell	RP48-MS-P	\$959
W 19.5 D 21.5 H 32 SH 18.25	Optional Glides: Add \$8.00 net per chair for a set of four (4)	

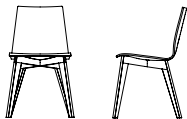

**Rapson Forty-Eight
Maple Frame Side Chair**

	MODEL	COM/COL	A	B	C	D	E	F	G	H	I	J	K	L
Premium HPL Shell, Upholstered seat pad	RP48-SS-P	\$1025	1065	1086	1105	1126	1145	1166	1186	1206	1226	1246	1266	1286
W 19.5 D 21.5 H 32 SH 18.25	COM Yardage: 1 or 2 chairs: 1 yard Contact Leland Customer Experience for yardage requirements on textiles with repeats. For COL requirements please contact Leland Customer Experience. Optional Glides: Add \$8.00 net per chair for a set of four (4)													

To specify:
 Please refer to pages 3-4 for
 complete specifying information.
 Specify all products by their
 product code.

Pricing Effective: July 2021

RAPSON FORTY-EIGHT FOUR LEG STEEL FRAME
COUNTER CHAIR Design: Ralph Rapson

RP48-C9

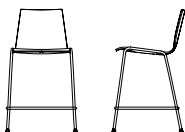

**Rapson Forty-Eight
Steel Frame Counter Chair**

	MODEL	LIST PRICE
Standard HPL Shell	RP48-SC-H	\$788

W 19.75 D 20.75 H 32 SH 24

Optional Glides: Add \$8.00 net per chair for a set of four (4)

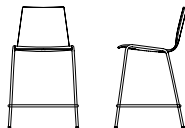

**Rapson Forty-Eight
Steel Frame Counter Chair**

	MODEL	COM/COL	A	B	C	D	E	F	G	H	I	J	K	L
Standard HPL Shell, upholstered seat pad	RP48-SC-HU	\$855	895	915	935	955	975	995	1016	1035	1056	1075	1096	1115

W 19.75 D 20.75 H 32 SH 24

COM Yardage: 1 or 2 chairs: 1 yard
Contact Leland Customer Experience for yardage requirements on textiles with repeats.
For COL requirements please contact Leland Customer Experience.
Optional Glides: Add \$8.00 net per chair for a set of four (4)

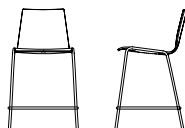

**Rapson Forty-Eight
Steel Frame Counter Chair**

	MODEL	COM/COL	A	B	C	D	E	F	G	H	I	J	K	L
Fully Upholstered	RP48-SC-FU	\$888	968	1008	1049	1089	1129	1169	1209	1249	1290	1330	1370	1410

W 19.75 D 20.75 H 32 SH 24

COM Yardage: 1.5 yards
Contact Leland Customer Experience for yardage requirements on textiles with repeats.
For COL requirements please contact Leland Customer Experience.
Optional Glides: Add \$8.00 net per chair for a set of four (4)

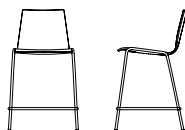

**Rapson Forty-Eight
Steel Frame Counter Chair**

	MODEL	LIST PRICE
Standard Shell	RP48-SC-MP	\$804

W 19.75 D 20.75 H 32 SH 24

Optional Glides: Add \$8.00 net per chair for a set of four (4)

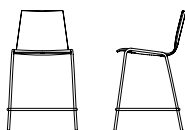

**Rapson Forty-Eight
Steel Frame Counter Chair**

	MODEL	COM/COL	A	B	C	D	E	F	G	H	I	J	K	L
Standard Shell, upholstered seat pad	RP48-SC-MPU	\$871	912	932	952	972	992	1012	1032	1052	1072	1092	1112	1132

W 19.75 D 20.75 H 32 SH 24

COM Yardage: 1 or 2 chairs: 1 yard
Contact Leland Customer Experience for yardage requirements on textiles with repeats.
For COL requirements please contact Leland Customer Experience.
Optional Glides: Add \$8.00 net per chair for a set of four (4)

**To specify:
Please refer to pages 3-4 for
complete specifying information.
Specify all products by their
product code.**

RAPSON FORTY-EIGHT FOUR LEG STEEL FRAME
COUNTER CHAIR Design: Ralph Rapson

RP48-C10

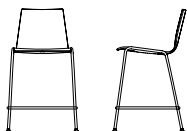

**Rapson Forty-Eight
Steel Frame Counter Chair**

MODEL	LIST PRICE
Walnut Shell RP48-SC-W	\$822

W 19.75 D 20.75 H 32 SH 24 Optional Glides: Add \$8.00 net per chair for a set of four (4)

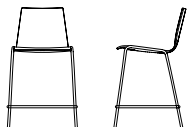

**Rapson Forty-Eight
Steel Frame Counter Chair**

MODEL	COM/COL	A	B	C	D	E	F	G	H	I	J	K	L
Walnut Shell, upholstered seat pad RP48-SC-WU	\$888	928	949	968	989	1008	1029	1049	1069	1089	1109	1129	1149

W 19.75 D 20.75 H 32 SH 24

COM Yardage: 1 or 2 chairs: 1 yard
Contact Leland Customer Experience for yardage requirements on textiles with repeats.
For COL requirements please contact Leland Customer Experience.
Optional Glides: Add \$8.00 net per chair for a set of four (4)

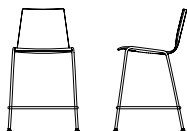

**Rapson Forty-Eight
Steel Frame Counter Chair**

MODEL	LIST PRICE
Premium HPL Shell RP48-SC-P	\$960

W 19.75 D 20.75 H 32 SH 24 Optional Glides: Add \$8.00 net per chair for a set of four (4)

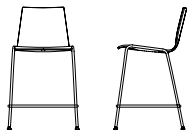

**Rapson Forty-Eight
Steel Frame Counter Chair**

MODEL	COM/COL	A	B	C	D	E	F	G	H	I	J	K	L
Premium HPL Shell, Upholstered seat pad RP48-SC-PU	\$1027	1062	1083	1102	1123	1142	1163	1182	1202	1223	1242	1263	1282

W 19.75 D 20.75 H 32 SH 24

COM Yardage: 1 or 2 chairs: 1 yard
Contact Leland Customer Experience for yardage requirements on textiles with repeats.
For COL requirements please contact Leland Customer Experience.
Optional Glides: Add \$8.00 net per chair for a set of four (4)

To specify:
Please refer to pages 3-4 for complete specifying information.
Specify all products by their product code.

Pricing Effective: July 2021

RAPSON FORTY-EIGHT MAPLE FRAME
COUNTER CHAIR Design: Ralph Rapson

RP48-C11

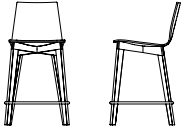

**Rapson Forty-Eight
Maple Frame Counter Chair**

MODEL	LIST PRICE
Standard HPL Shell RP48-MC-H	\$1247

W 18.5 D 20 H 35 SH 24

Optional Glides: Add \$8.00 net per chair for a set of four (4)

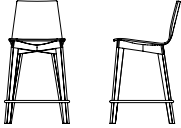

**Rapson Forty-Eight
Maple Frame Counter Chair**

MODEL	COM/COL	A	B	C	D	E	F	G	H	I	J	K	L
Standard HPL Shell, upholstered seat pad RP48-MC-HU	\$1314	1354	1374	1394	1414	1434	1454	1474	1495	1514	1535	1554	1575

W 18.5 D 20 H 35 SH 24

COM Yardage: 1 or 2 chairs: 1 yard
Contact Leland Customer Experience for yardage requirements on textiles with repeats.
For COL requirements please contact Leland Customer Experience.
Optional Glides: Add \$8.00 net per chair for a set of four (4)

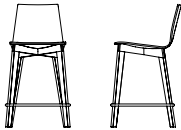

**Rapson Forty-Eight
Maple Frame Counter Chair**

MODEL	COM/COL	A	B	C	D	E	F	G	H	I	J	K	L
Fully Upholstered RP48-MC-FU	\$1347	1428	1468	1508	1548	1588	1628	1669	1708	1748	1788	1828	1868

W 18.5 D 20 H 35 SH 24

COM Yardage: 1.5 yards
Contact Leland Customer Experience for yardage requirements on textiles with repeats.
For COL requirements please contact Leland Customer Experience.
Optional Glides: Add \$8.00 net per chair for a set of four (4)

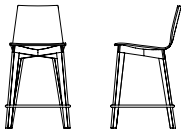

**Rapson Forty-Eight
Maple Frame Counter Chair**

MODEL	LIST PRICE
Standard Shell RP48-MC-MP	\$1264

W 18.5 D 20 H 35 SH 24

Optional Glides: Add \$8.00 net per chair for a set of four (4)

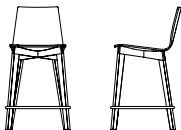

**Rapson Forty-Eight
Maple Frame Counter Chair**

MODEL	COM/COL	A	B	C	D	E	F	G	H	I	J	K	L
Standard Shell, upholstered seat pad RP48-MC-MPU	\$1331	1371	1391	1411	1431	1451	1471	1491	1511	1531	1551	1571	1591

W 18.5 D 20 H 35 SH 24

COM Yardage: 1 or 2 chairs: 1 yard
Contact Leland Customer Experience for yardage requirements on textiles with repeats.
For COL requirements please contact Leland Customer Experience.
Optional Glides: Add \$8.00 net per chair for a set of four (4)

**To specify:
Please refer to pages 3-4 for
complete specifying information.
Specify all products by their
product code.**

RAPSON FORTY-EIGHT MAPLE FRAME
COUNTER CHAIR Design: Ralph Rapson

RP48-C12

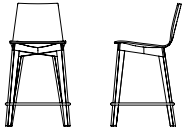

**Rapson Forty-Eight
Maple Frame Counter Chair**

	MODEL	LIST PRICE
Walnut Shell	RP48-MC-W	\$1396
W 18.5 D 20 H 35 SH 24	Optional Glides: Add \$8.00 net per chair for a set of four (4)	

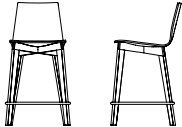

**Rapson Forty-Eight
Maple Frame Counter Chair**

	MODEL	COM/COL	A	B	C	D	E	F	G	H	I	J	K	L
Walnut Shell, upholstered seat pad	RP48-MC-WU	\$1462	1502	1522	1542	1563	1582	1603	1622	1643	1662	1683	1703	1722
W 18.5 D 20 H 35 SH 24	COM Yardage: 1 or 2 chairs: 1 yard Contact Leland Customer Experience for yardage requirements on textiles with repeats. For COL requirements please contact Leland Customer Experience. Optional Glides: Add \$8.00 net per chair for a set of four (4)													

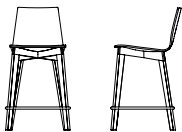

**Rapson Forty-Eight
Maple Frame Counter Chair**

	MODEL	LIST PRICE
Premium HPL Shell	RP48-MC-P	\$1534
W 18.5 D 20 H 35 SH 24	Optional Glides: Add \$8.00 net per chair for a set of four (4)	

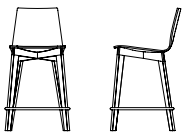

**Rapson Forty-Eight
Maple Frame Counter Chair**

	MODEL	COM/COL	A	B	C	D	E	F	G	H	I	J	K	L
Premium HPL Shell, Upholstered seat pad	RP48-MC-PU	\$1601	1640	1660	1680	1701	1720	1741	1760	1781	1800	1821	1841	1861
W 18.5 D 20 H 35 SH 24	COM Yardage: 1 or 2 chairs: 1 yard Contact Leland Customer Experience for yardage requirements on textiles with repeats. For COL requirements please contact Leland Customer Experience. Optional Glides: Add \$8.00 net per chair for a set of four (4)													

To specify:
Please refer to pages 3-4 for complete specifying information.
Specify all products by their product code.

Pricing Effective: July 2021

RAPSON FORTY-EIGHT FOUR LEG STEEL FRAME
BAR CHAIR Design: Ralph Rapson

RP48-C13

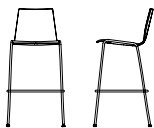

**Rapson Forty-Eight
Steel Frame Bar Chair**

	MODEL	LIST PRICE
Standard HPL Shell	RP48-SB-H	\$801

W 20 D 23 H 41 SH 30

Optional Glides: Add \$8.00 net per chair for a set of four (4)



**Rapson Forty-Eight
Steel Frame Bar Chair**

	MODEL	COM/COL	A	B	C	D	E	F	G	H	I	J	K	L
Standard HPL Shell, upholstered seat pad	RP48-SB-HU	\$868	908	928	949	968	989	1008	1029	1049	1069	1089	1109	1129

W 20 D 23 H 41 SH 30

COM Yardage: 1 or 2 chairs: 1 yard
Contact Leland Customer Experience for yardage requirements on textiles with repeats.
For COL requirements please contact Leland Customer Experience.
Optional Glides: Add \$8.00 net per chair for a set of four (4)

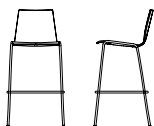

**Rapson Forty-Eight
Steel Frame Bar Chair**

	MODEL	COM/COL	A	B	C	D	E	F	G	H	I	J	K	L
Fully Upholstered	RP48-SB-FU	\$901	982	1022	1062	1102	1142	1182	1223	1263	1303	1343	1383	1423

W 20 D 23 H 41 SH 30

COM Yardage: 1.5 yards
Contact Leland Customer Experience for yardage requirements on textiles with repeats.
For COL requirements please contact Leland Customer Experience.
Optional Glides: Add \$8.00 net per chair for a set of four (4)



**Rapson Forty-Eight
Steel Frame Bar Chair**

	MODEL	LIST PRICE
Standard Shell	RP48-SB-MP	\$818

W 20 D 23 H 41 SH 30

Optional Glides: Add \$8.00 net per chair for a set of four (4)



**Rapson Forty-Eight
Steel Frame Bar Chair**

	MODEL	COM/COL	A	B	C	D	E	F	G	H	I	J	K	L
Standard Shell, upholstered seat pad	RP48-SB-MPU	\$885	925	946	965	986	1005	1025	1045	1065	1086	1105	1126	1145

W 20 D 23 H 41 SH 30

COM Yardage: 1 or 2 chairs: 1 yard
Contact Leland Customer Experience for yardage requirements on textiles with repeats.
For COL requirements please contact Leland Customer Experience.
Optional Glides: Add \$8.00 net per chair for a set of four (4)

**To specify:
Please refer to pages 3-4 for
complete specifying information.
Specify all products by their
product code.**

RAPSON FORTY-EIGHT FOUR LEG STEEL FRAME
BAR CHAIR Design: Ralph Rapson

RP48-C14

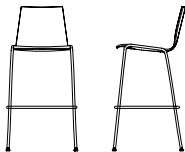

**Rapson Forty-Eight
Steel Frame Bar Chair**

	MODEL	LIST PRICE
Walnut Shell	RP48-SB-W	\$836
W 20 D 23 H 41 SH 30	Optional Glides: Add \$8.00 net per chair for a set of four (4)	

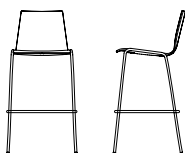

**Rapson Forty-Eight
Steel Frame Bar Chair**

	MODEL	COM/COL	A	B	C	D	E	F	G	H	I	J	K	L
Walnut Shell, upholstered seat pad	RP48-SB-WU	\$903	942	963	983	1003	1023	1043	1063	1084	1103	1124	1143	1164
W 20 D 23 H 41 SH 30	COM Yardage: 1 or 2 chairs: 1 yard Contact Leland Customer Experience for yardage requirements on textiles with repeats. For COL requirements please contact Leland Customer Experience. Optional Glides: Add \$8.00 net per chair for a set of four (4)													

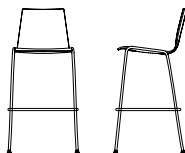

**Rapson Forty-Eight
Steel Frame Bar Chair**

	MODEL	LIST PRICE
Premium HPL Shell	RP48-SB-P	\$973
W 20 D 23 H 41 SH 30	Optional Glides: Add \$8.00 net per chair for a set of four (4)	

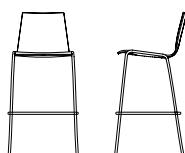

**Rapson Forty-Eight
Steel Frame Bar Chair**

	MODEL	COM/COL	A	B	C	D	E	F	G	H	I	J	K	L
Premium HPL Shell, Upholstered seat pad	RP48-SB-PU	\$935	1075	1096	1115	1136	1156	1175	1196	1215	1236	1256	1276	1296
W 20 D 23 H 41 SH 30	COM Yardage: 1 or 2 chairs: 1 yard Contact Leland Customer Experience for yardage requirements on textiles with repeats. For COL requirements please contact Leland Customer Experience. Optional Glides: Add \$8.00 net per chair for a set of four (4)													

To specify:
 Please refer to pages 3-4 for complete specifying information.
 Specify all products by their product code.

Pricing Effective: July 2021

RAPSON FORTY-EIGHT MAPLE FRAME
BAR CHAIR Design: Ralph Rapson

RP48-C15



**Rapson Forty-Eight
Maple Frame Bar Chair**

MODEL	LIST PRICE
Standard HPL Shell RP48-MB-H	\$1489

W 19.5 D 20.5 H 41 SH 30

Optional Glides: Add \$8.00 net per chair for a set of four (4)



**Rapson Forty-Eight
Maple Frame Bar Chair**

MODEL	COM/COL	A	B	C	D	E	F	G	H	I	J	K	L
Standard HPL Shell, upholstered seat pad RP48-MB-HU	\$1556	1597	1617	1637	1657	1677	1697	1717	1738	1757	1777	1797	1817

W 19.5 D 20.5 H 41 SH 30

COM Yardage: 1 or 2 chairs: 1 yard
Contact Leland Customer Experience for yardage requirements on textiles with repeats.
For COL requirements please contact Leland Customer Experience.
Optional Glides: Add \$8.00 net per chair for a set of four (4)



**Rapson Forty-Eight
Maple Frame Bar Chair**

MODEL	COM/COL	A	B	C	D	E	F	G	H	I	J	K	L
Fully Upholstered RP48-MB-FU	\$1590	1671	1711	1751	1790	1830	1870	1911	1951	1991	2031	2071	2112

W 19.5 D 20.5 H 41 SH 30

COM Yardage: 1.5 yards
Contact Leland Customer Experience for yardage requirements on textiles with repeats.
For COL requirements please contact Leland Customer Experience.
Optional Glides: Add \$8.00 net per chair for a set of four (4)



**Rapson Forty-Eight
Maple Frame Bar Chair**

MODEL	LIST PRICE
Standard Shell RP48-MB-MP	\$1507

W 19.5 D 20.5 H 41 SH 30

Optional Glides: Add \$8.00 net per chair for a set of four (4)



**Rapson Forty-Eight
Maple Frame Bar Chair**

MODEL	COM/COL	A	B	C	D	E	F	G	H	I	J	K	L
Standard Shell, upholstered seat pad RP48-SB-MPU	\$1574	1614	1634	1653	1674	1693	1714	1733	1754	1774	1794	1814	1834

W 19.5 D 20.5 H 41 SH 30

COM Yardage: 1 or 2 chairs: 1 yard
Contact Leland Customer Experience for yardage requirements on textiles with repeats.
For COL requirements please contact Leland Customer Experience.
Optional Glides: Add \$8.00 net per chair for a set of four (4)

**To specify:
Please refer to pages 3-4 for
complete specifying information.
Specify all products by their
product code.**

Pricing Effective: July 2021

RAPSON FORTY-EIGHT FOUR MAPLE FRAME
BAR CHAIR Design: Ralph Rapson

RP48-C16



**Rapson Forty-Eight
Maple Frame Bar Chair**

	MODEL	LIST PRICE
Walnut Shell	RP48-MB-W	\$1639
W 19.5 D 20.5 H 41 SH 30	Optional Glides: Add \$8.00 net per chair for a set of four (4)	



**Rapson Forty-Eight
Maple Frame Bar Chair**

	MODEL	COM/COL	A	B	C	D	E	F	G	H	I	J	K	L
Walnut Shell, upholstered seat pad	RP48-MB-WU	\$1706	1746	1766	1786	1807	1826	1847	1866	1886	1907	1926	1947	1966
W 19.5 D 20.5 H 41 SH 30	COM Yardage: 1 or 2 chairs: 1 yard Contact Leland Customer Experience for yardage requirements on textiles with repeats. For COL requirements please contact Leland Customer Experience. Optional Glides: Add \$8.00 net per chair for a set of four (4)													



**Rapson Forty-Eight
Maple Frame Bar Chair**

	MODEL	LIST PRICE
Premium HPL Shell	RP48-MB-P	\$1776
W 19.5 D 20.5 H 41 SH 30	Optional Glides: Add \$8.00 net per chair for a set of four (4)	



**Rapson Forty-Eight
Maple Frame Bar Chair**

	MODEL	COM/COL	A	B	C	D	E	F	G	H	I	J	K	L
Premium HPL Shell, Upholstered seat pad	RP48-MB-PU	\$1843	1883	1903	1923	1944	1963	1984	2003	2024	2044	2063	2084	2103
W 19.5 D 20.5 H 41 SH 30	COM Yardage: 1 or 2 chairs: 1 yard Contact Leland Customer Experience for yardage requirements on textiles with repeats. For COL requirements please contact Leland Customer Experience. Optional Glides: Add \$8.00 net per chair for a set of four (4)													

To specify:
 Please refer to pages 3-4 for
 complete specifying information.
 Specify all products by their
 product code.

Pricing Effective: July 2021

Painted Back	MODEL	LIST PRICE
	Reference color codes on page RP48-C3	\$173

Handhold	MODEL	LIST PRICE
	HH	\$30

To specify:
Please refer to pages 3-4 for
complete specifying information.
Specify all products by their
product code.

5695 Eagle Drive, SE
Grand Rapids,
Michigan 49512
616-975-9260
lelandfurniture.com

Rapson Thirty-Nine

July 2021 Price List

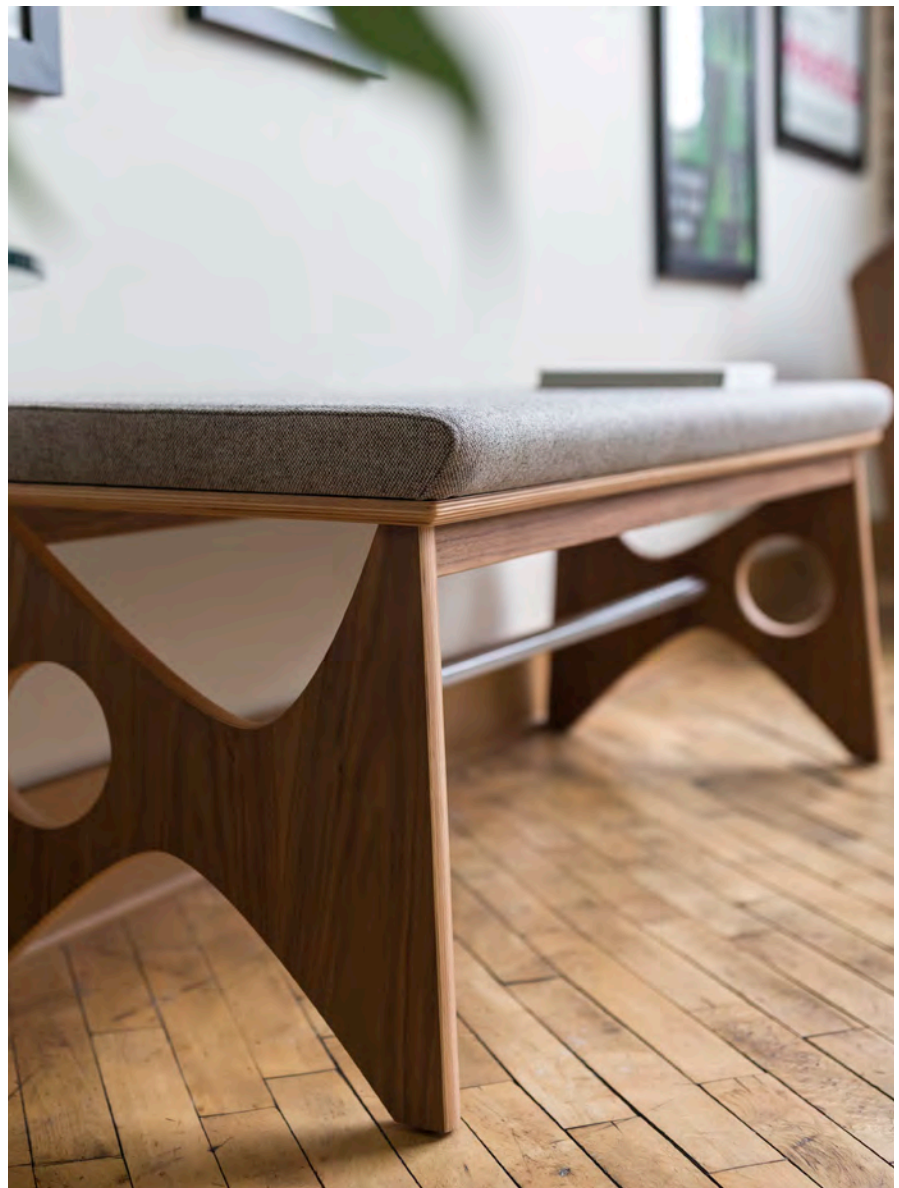

Rapson Thirty-Nine Bench

Table of Contents	RP39-BN2
Specification Information	RP39-BN3
Specification Example	RP39-BN4
Rapson Thirty-Nine Bench 20"	RP39-BN5
Rapson Thirty-Nine Bench 48"	RP39-BN5

Bench Model

DESCRIPTION	CODE
Rapson Thirty-Nine Bench	RP39-BN

Bench Width

DESCRIPTION	CODE
20"	20
48"	48

Bench Frame and Button Finish Options

DESCRIPTION	CODE
Natural Walnut	08M
Natural Ash	07M

Upholstery Selection

Please refer to Leland Textile Program which features textiles and leathers from the following partners:

- Camira
- Green Hides
- Carnegie
- Maharam
- CF Stinson
- Unika Vaev

The complete grade list can be found at lelandinternational.com/ecatalog or you can specify COM/COL. Due to the design of this product, it is recommended that all non pre-approved textile be tested for compatibility.

Glide Option

DESCRIPTION	CODE
Nylon (standard)	S
Felt	F

RAPSON THIRTY-NINE BENCH
SPECIFICATION EXAMPLE

RP39-BN4

Specifications required to create the product code

- Model
- Bench Width
- Bench Frame and Button Finish Selection
- Upholstery Selection
- Glide Option

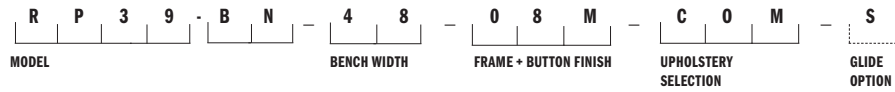

MODEL

Rapson Thirty-Nine Bench (RP39-BN)

BENCH WIDTH

48" (48)

BENCH FRAME + BUTTON FINISH

Natural Walnut (08M)

UPHOLSTERY SELECTION

Enter upholstery grade or COM

GLIDE OPTION

Nylon (S)



RAPSON THIRTY-NINE BENCH
Design: Ralph Rapson

RP39-BN5

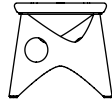
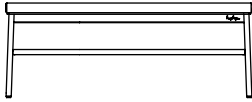

Rapson Thirty-Nine	MODEL	COM/COL	A	B	C	D	E	F	G	H	I	J	K	L
48" Bench	RP39-BN-48	\$1987	2069	2109	2150	2191	2232	2273	2314	2354	2395	2436	2477	2518

W 48.5 D 19.25 H 18.5

COM Yardage: 1.5 yards
Contact Leland Customer Experience for yardage requirements on textiles with repeats.
For COL requirements please contact Leland Customer Experience.

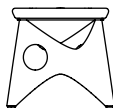

Rapson Thirty-Nine	MODEL	COM/COL	A	B	C	D	E	F	G	H	I	J	K	L
20" Bench	RP39-BN-20	\$1243	1271	1284	1298	1311	1325	1339	1351	1365	1379	1392	1406	1420

W 19.5 D 19.25 H 18.5

COM Yardage: 1.5 yards
Contact Leland Customer Experience for yardage requirements on textiles with repeats.
For COL requirements please contact Leland Customer Experience.

To specify:
Please refer to pages 3-4 for complete specifying information.
Specify all products by their product code.

Pricing Effective: July 2021

**5695 Eagle Drive, SE
Grand Rapids,
Michigan 49512
616-975-9260
lelandfurniture.com**

Rapson Thirty-Nine Guest

July 2021 Price List



Rapson Thirty- Nine Guest

Table of Contents	RP39-G2
Specification Information	RP39-G3
Specification Example	RP39-G4
Guest Chair	RP39-G5

Chair Model

DESCRIPTION	CODE
Rapson Thirty-Nine Guest Chair	RP39-G

Frame Finish Options

DESCRIPTION	CODE
Natural Walnut	08M
Natural Ash	07M

Fully Upholstered or Onlay Selection

Please refer to Leland Textile Program which features textiles and leathers from the following partners:

- Camira
- Carnegie
- CF Stinson
- Green Hides
- Maharam
- Unika Vaev

The complete grade list can be found at www.lelandfurniture.com/ecatalog or you can specify COM/COL. Due to the design of this product, it is recommended that all non pre-approved textile be tested for compatibility.

Optional Contrasted Upper Back Upholstery

Please refer to Leland Textile Program which features textiles and leathers from the following partners:

- Camira
- Carnegie
- CF Stinson
- Green Hides
- Maharam
- Unika Vaev

The complete grade list can be found at www.lelandfurniture.com/ecatalog or you can specify COM/COL. Due to the design of this product, it is recommended that all non pre-approved textile be tested for compatibility.

Glide Option

DESCRIPTION	CODE
Nylon (standard)	S
Felt	F

Specifications required to create the product code

- Model
- Frame Finish Selection
- Upholstery Selection
- Optional Upper Back Upholstery
- Glide Option



MODEL

Rapson Thirty-Nine Guest (RP39-G)

FRAME FINISH

Natural Walnut (08M)

UPHOLSTERY SELECTION

Enter upholstery grade or COM

GLIDE OPTION

Nylon (S)



RAPSON THIRTY-NINE GUEST
 Design: Ralph Rapson

RP39-G5

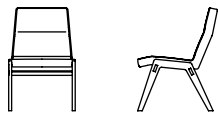

Rapson Thirty-Nine

	MODEL	COM/COL	A	B	C	D	E	F	G	H	I	J	K	L
Guest Chair	RP39-G	\$2363	2444	2485	2526	2567	2608	2649	2689	2730	2771	2812	2853	2894

W 22 D 27 H 35 SH 18.5

COM Yardage: 1 seat: 2.75 yards
 Contact Leland Customer Experience for yardage requirements on textiles with repeats.
 Optional Glides: Add \$8.00 net per chair for a set of four (4).

To specify:
 Please refer to pages 3-4 for complete specifying information.
 Specify all products by their product code.

Pricing Effective: July 2021

5695 Eagle Drive, SE
Grand Rapids,
Michigan 49512
616-975-9260
lelandfurniture.com

Rapson Thirty-Nine Lounge

July 2021 Price List



Rapson Thirty-Nine Lounge

Table of Contents	RP39-L2
Specification Information	RP39-L3
Specification Example	RP39-L4
Rapson Thirty-Nine Lounge	RP39-L5

Chair Model

DESCRIPTION	CODE
Rapson Thirty-Nine Lounge Chair	RP39-L

Frame Finish Options

DESCRIPTION	CODE
Natural Walnut	08M
Natural Ash	07M

Fully Upholstered or Onlay Selection

Please refer to Leland Textile Program which features textiles and leathers from the following partners:

- Camira
- Carnegie
- CF Stinson
- Green Hides
- Maharam
- Unika Vaev

The complete grade list can be found at www.lelandfurniture.com/ecatalog or you can specify COM/COL. Due to the design of this product, it is recommended that all non pre-approved textile be tested for compatibility.

Glide Option

DESCRIPTION	CODE
Nylon (standard)	S
Felt	F

Specifications required to create the product code

- Model
- Frame Finish Selection
- Upholstery Selection
- Glide Option

R **P** **3** **9** - **L** - **0** **8** **M** - **C** **O** **M** - **S**
MODEL FRAME FINISH UPHOLSTERY SELECTION GLIDE OPTION

MODEL

Rapson Thirty-Nine Lounge (RP39-L)

FRAME FINISH

Natural Walnut (08M)

UPHOLSTERY SELECTION

Enter upholstery grade or COM

GLIDE OPTION

Nylon (S)



RAPSON THIRTY-NINE LOUNGE
 Design: Ralph Rapson

RP39-L5

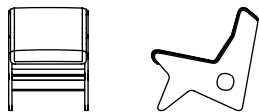

Rapson Thirty-Nine

	MODEL	COM/COL	A	B	C	D	E	F	G	H	I	J	K	L
Lounge Chair	RP39-L	\$2799	2895	2943	2990	3039	3086	3133	3182	3229	3277	3324	3372	3420

W 24 D 32.25 H 31 SH 18.25

COM Yardage: 1 seat: 1.75 yards
 Contact Leland Customer Experience for yardage requirements on textiles with repeats.
 Optional Glides: Add \$8.00 net per chair for a set of four (4).

To specify:
 Please refer to pages 3-4 for complete specifying information.
 Specify all products by their product code.

Pricing Effective: July 2021

5695 Eagle Drive, SE
Grand Rapids,
Michigan 49512
616-975-9260
lelandfurniture.com

Slam

July 2021 Price List



Slam

Table of Contents	SL2
Specification Information	SL3
Specification Example	SL4
Sled Base	SL5
Stacking Four-Leg Base	SL7
Wood Leg Chair	SL9
Stacking Four-Leg Mobile Base	SL10
Side Chair, Aluminum Base	SL12
Arm Chair, Aluminum Base	SL14
Task Base	SL16
Sled Counter Chair	SL18
Four-Leg Counter Chair	SL20
Sled Bar Chair	SL22
Four-Leg Bar Chair	SL24
Stacking/Transport Dolly	SL26
Lounge Chair	SL27

Chair Model

DESCRIPTION	CODE
SLAM sled base	SLS
SLAM stacking 4-leg base	SL4
SLAM stacking 4-leg mobile base	SLM
SLAM side chair, aluminum base	SLA
SLAM arm chair, aluminum base	SLAA
SLAM task base	SLTB
SLAM side chair, wood leg	SLW
SLAM sled, counter chair	SLCS
SLAM 4-leg, counter chair	SLC4
SLAM sled, bar chair	SLBS
SLAM 4-leg, bar chair	SLB4
SLAM lounge	SLL

Shell Selection

DESCRIPTION	CODE
Polypropylene	PO
Polypropylene with Upholstered Seat Onlay	PU
Fully Upholstered	FU
3D Beech Veneer	3DB
3D Beech Veneer with Upholstered Seat Onlay	3BU
3D Oak Veneer	3DO
3D Oak Veneer with Upholstered Seat Onlay	3OU

Shell Finish/Color**POLYPROPYLENE SHELL:**

DESCRIPTION	CODE	DESCRIPTION	CODE
White	WT	Grey	G
Black	BK	Arctic	AR
Caribbean	CB	Soda Red	SR
Ink	IN	Dolphin	DL
Limelight	LL	Oxford	OX
Tangerine	TN	Ice Blue	IB

CUSTOM POLYPROPYLENE COLORS

Custom color match is available upon request. Please contact hello@lelandinternational.com for further information

BEECH 3D VENEER SHELL:

DESCRIPTION	CODE
Natural Beech	09

STANDARD LELAND COLORS**OAK 3D VENEER SHELL:**

DESCRIPTION	ODE
Natural White Oak	12

Fully Upholstered or Onlay Selection

Please refer to Leland Textile Program which features textiles and leathers from the following partners:

- Camira
- Carnegie
- CF Stinson
- Green Hides
- Maharam
- Unika Vaev

The complete grade list can be found at www.lelandfurniture.com/ecatalog or you can specify COM/COL. Due to the design of this product, it is recommended that all non pre-approved textile be tested for compatibility.

Pricing Effective: July 2021

Frame Finish

DESCRIPTION	CODE
Textured Frame Finish	
White Textured Powder Coat	WT
Black Textured Powder Coat	BT
Grey Textured Powder Coat	GT
Soda Red Textured	SRT
Dolphin Textured	DLT
Oxford Textured	OXT
Tangerine Textured	TNT
Ice Blue Textured	IBT
Arctic Textured	ART
Caribbean Textured	CBT
Limelight Textured	LLT
Ink Textured	INT
Warm Grey	WG
Cool Grey	CG
Black	B
White	W
Matte Gold Rush	MGR
Matte Mercury	MMR
Matte Mineral	MMN
Matte Burnish	MBN
Matte Foundry	MFN
Matte New Penny	MNP
Sterling	ST
Chrome	C
Polished Aluminum (Aluminum models only)	P

Wood Leg Finish

LELAND COLORS**Glide or Caster Type****STANDARD GLIDES:**

DESCRIPTION	CODE
Poly (Sled base)	S
Nylon (4-Leg, Aluminum base)	S
Rubber (Slam Wood Leg)	S

OPTIONAL GLIDES:

DESCRIPTION	CODE
Felt	FC
Floor Saver™ (for VCT type floors) (4-Leg base only)	FS
Metal (4-Leg base only)	M
Rubber (4-Leg base or Aluminum Base only)	R

*Please note that optional glides for four leg models raise the chair height .5 inch.

CASTER TYPE:

(for 4-leg mobile and task base)

DESCRIPTION	CODE
Hard Floor Caster	HF
Soft Floor Caster	SF

(Slam Task Base comes with universal hard and soft floor casters)

Stacking note

SLAM side chair, 4 leg base and 4 leg mobile base in Polypropylene or Veneer shells are the only versions recommended for stacking. Stacking any other version could result in frame or shell damage.

Specifications required to create the product code

- Model
- Shell Selection
- Shell Finish
- Upholstered Onlay Selection (when applicable)
- Frame Finish
- Glide or Caster Type



MODEL

Slam arm chair, aluminum base (SLAA)

SHELL SELECTION

3D Veneer (3D)

SHELL FINISH

Natural White Oak (12)

UPHOLSTERED ONLAY SELECTION

When applicable, enter upholstery grade, COM



FRAME FINISH

Polished Aluminum (P)

GLIDE OR CASTER TYPE

Standard Nylon (S)



SLAM SLED BASE CHAIR
 Design: Lievore Altherr Molina, licensed by Sellex

SL5



Slam Sled Base Chair	MODEL	FRAME FINISH	LIST PRICE
Polypropylene shell	SLS-PO	Powder Coat	\$416
W 22.5 D 20.75 H 31.75 SH 18		Chrome	\$475



Slam Sled Base Chair	MODEL	LIST PRICE/GRADE	COM/COL	A	B	C	D	E	F	G	H	I	J	K	L
Polypropylene shell, upholstered seat onlay	SLS-PU	Powder Coat	\$546	607	639	670	701	733	764	795	827	858	889	921	952
		Chrome	\$605	667	698	729	761	792	824	855	886	918	949	980	1012
W 22.5 D 20.75 H 31.75 SH 18.25		COM Yardage: 1 or 2 seats: .75 yard Contact Leland Customer Experience for yardage requirements on textiles with repeats. For COL requirements please contact Leland Customer Experience.													



Slam Sled Base Chair	MODEL	LIST PRICE/GRADE	COM/COL	A	B	C	D	E	F	G	H	I	J	K	L
Fully upholstered	SLS-FU	Powder Coat	\$674	783	838	891	946	1001	1055	1110	1164	1219	1274	1328	1383
		Chrome	\$737	846	901	956	1010	1065	1119	1190	1250	1310	1371	1431	1492
W 22.5 D 20.75 H 31.75 SH 18.25		COM Yardage: 1 seat: 1.5 yards Contact Leland Customer Experience for yardage requirements on textiles with repeats. For COL requirements please contact Leland Customer Experience.													

To specify:
 Please refer to pages 3-4 for complete specifying information.
 Specify all products by their product code.

Pricing Effective: July 2021

SLAM SLED BASE CHAIR
 Design: Lievore Altherr Molina, licensed by Sellex

SL6



Slam Sled Base Chair	MODEL	FRAME FINISH	LIST PRICE
3D Beech veneer shell	SLS-3DB	Powder Coat	\$967
W 22.5 D 20.75 H 31.75 SH 18		Chrome	\$1099



Slam Sled Base Chair	MODEL	LIST PRICE/ GRADE	COM/ COL	A	B	C	D	E	F	G	H	I	J	K	L
3D Beech veneer shell, upholstered seat onlay	SLS-3BU	Powder Coat	\$1099	1161	1192	1224	1255	1286	1318	1349	1380	1412	1443	1475	1506
		Chrome	\$1159	1220	1252	1283	1315	1346	1377	1409	1440	1471	1503	1534	1565
W 22.5 D 20.75 H 31.75 SH 18.25		COM Yardage: 1 or 2 seats: .75 yard Contact Leland Customer Experience for yardage requirements on textiles with repeats. Optional Glides: Add \$8.00 net per chair for a set of four (4).													



Slam Sled Base Chair	MODEL	FRAME FINISH	LIST PRICE
3D Oak veneer shell	SLS-3D0	Powder Coat	\$1119
W 22.5 D 20.75 H 31.75 SH 18		Chrome	\$1181



Slam Sled Base Chair	MODEL	LIST PRICE/ GRADE	COM/ COL	A	B	C	D	E	F	G	H	I	J	K	L
3D Oak veneer shell, upholstered seat onlay	SLS-30U	Powder Coat	\$1252	1313	1345	1376	1408	1439	1470	1502	1533	1564	1596	1627	1658
		Chrome	\$1311	1373	1404	1436	1467	1498	1530	1561	1592	1624	1655	1687	1718
W 22.5 D 20.75 H 31.75 SH 18.25		COM Yardage: 1 or 2 seats: .75 yard Contact Leland Customer Experience for yardage requirements on textiles with repeats. Optional Glides: Add \$8.00 net per chair for a set of four (4).													

To specify:
 Please refer to pages 3-4 for complete specifying information.
 Specify all products by their product code.

Pricing Effective: July 2021

SLAM 4-LEG BASE CHAIR
 Design: Lievore Altherr Molina, licensed by Sellex

SL7



**Slam Stacking
 4-Leg Base Chair**

	MODEL	FRAME FINISH	LIST PRICE
Polypropylene shell	SL4-PO	Powder Coat	\$431
W 20.75 D 19.75 H 31 SH 18		Chrome	\$492

Optional Glides: Add \$8.00 net per chair for a set of four (4). Optional Glides raise chair height .5 inch.



Slam 4-Leg Base Chair

	MODEL	LIST PRICE/GRADE	COM/COL	A	B	C	D	E	F	G	H	I	J	K	L
Polypropylene shell, upholstered seat onlay	SL4-PU	Powder Coat	\$562	623	655	686	718	749	780	812	843	874	906	937	968
		Chrome	\$623	685	716	748	779	811	842	873	905	936	967	999	1030

W 20.75 D 19.75 H 31 SH 18.25

Optional Glides: Add \$8.00 net per chair for a set of four (4). Optional Glides raise chair height .5 inch.
 COM Yardage: 1 or 2 seats: .75 yard
 Contact Leland Customer Experience for yardage requirements on textiles with repeats.
 For COL requirements please contact Leland Customer Experience.



Slam 4-Leg Base Chair

	MODEL	LIST PRICE/GRADE	COM/COL	A	B	C	D	E	F	G	H	I	J	K	L
Fully upholstered	SL4-FU	Powder Coat	\$692	801	856	910	965	1020	1074	1128	1182	1237	1292	1346	1401
		Chrome	\$756	865	919	973	1028	1083	1137	1192	1246	1301	1356	1410	1465

W 20.75 D 19.75 H 31 SH 18.25

Optional Glides: Add \$8.00 net per chair for a set of four (4). Optional Glides raise chair height .5 inch.
 COM Yardage: 1 seat: 1.5 yards
 Contact Leland Customer Experience for yardage requirements on textiles with repeats.
 For COL requirements please contact Leland Customer Experience.

To specify:
 Please refer to pages 3-4 for
 complete specifying information.
 Specify all products by their
 product code.

Pricing Effective: July 2021

SLAM 4-LEG BASE CHAIR
 Design: Lievore Altherr Molina, licensed by Sellex

SL8



**Slam Stacking
 4-Leg Base Chair**

	MODEL	FRAME FINISH	LIST PRICE
3D Beech veneer shell W 20.75 D 19.75 H 31 SH 18	SL4-3DB	Powder Coat	\$984
		Chrome	\$1045

Optional Glides: Add \$8.00 net per chair for a set of four (4). Optional Glides raise chair height .5 inch.



Slam 4-Leg Base Chair

	MODEL	LIST PRICE/ GRADE	COM/ COL	A	B	C	D	E	F	G	H	I	J	K	L
3D Beech veneer shell, upholstered seat onlay W 20.75 D 19.75 H 31 SH 18.25	SL4-3BU	Powder Coat	\$1114	1176	1207	1239	1270	1302	1333	1364	1396	1427	1458	1490	1521
		Chrome	\$1177	1239	1270	1302	1333	1364	1396	1427	1458	1490	1521	1552	1584

Optional Glides: Add \$8.00 net per chair for a set of four (4). Optional Glides raise chair height .5 inch.
 COM Yardage: 1 or 2 seats: .75 yard
 Contact Leland Customer Experience for yardage requirements on textiles with repeats.
 For COL requirements please contact Leland Customer Experience.



**Slam Stacking
 4-Leg Base Chair**

	MODEL	FRAME FINISH	LIST PRICE
3D Oak veneer shell W 20.75 D 19.75 H 31 SH 18	SL4-3D0	Powder Coat	\$1137
		Chrome	\$1197

Optional Glides: Add \$8.00 net per chair for a set of four (4). Optional Glides raise chair height .5 inch.



**Slam Stacking
 4-Leg Base Chair**

	MODEL	LIST PRICE/ GRADE	COM/ COL	A	B	C	D	E	F	G	H	I	J	K	L
3D Oak veneer shell, upholstered seat onlay W 20.75 D 19.75 H 31 SH 18.25	SL4-30U	Powder Coat	\$1267	1329	1360	1391	1423	1454	1485	1517	1548	1579	1611	1642	1674
		Chrome	\$1330	1391	1423	1454	1485	1517	1548	1579	1611	1642	1674	1705	1736

Optional Glides: Add \$8.00 net per chair for a set of four (4). Optional Glides raise chair height .5 inch.
 COM Yardage: 1 or 2 seats: .75 yard
 Contact Leland Customer Experience for yardage requirements on textiles with repeats.
 For COL requirements please contact Leland Customer Experience.

To specify:
 Please refer to pages 3-4 for complete specifying information.
 Specify all products by their product code.

Pricing Effective: July 2021

SLAM SIDE CHAIR, WOOD LEG
 Design: Lievore Altherr Molina, licensed by Sellex

SL9



Slam Side Chair, Wood Leg	MODEL	LIST PRICE
Polypropylene shell W 22.5 D 21.5 H 31 SH 18	SLW-PO	\$682



Slam Side Chair, Wood Leg	MODEL	COM/COL	A	B	C	D	E	F	G	H	I	J	K	L
Polypropylene shell, upholstered seat onlay W 22.5 D 21.5 H 31 SH 18.25	SLW-PU	\$813	874	906	937	968	1000	1031	1063	1094	1125	1157	1188	1219

COM Yardage: 1 or 2 seats: .75 yard
 Contact Leland Customer Experience for yardage requirements on textiles with repeats.
 For COL requirements please contact Leland Customer Experience.



Slam Side Chair, Wood Leg	MODEL	COM/COL	A	B	C	D	E	F	G	H	I	J	K	L
Fully upholstered W 22.5 D 21.5 H 31 SH 18.25	SLW-FU	\$954	1064	1118	1173	1227	1281	1336	1390	1445	1499	1554	1609	1663

COM Yardage: 1 seat: 1.5 yards
 Contact Leland Customer Experience for yardage requirements on textiles with repeats.
 For COL requirements please contact Leland Customer Experience.



Slam Side Chair, Wood Leg	MODEL	LIST PRICE
3D Beech veneer shell W 22.5 D 21.5 H 31 SH 18	SLW-3DB	\$1269



Slam Side Chair, Wood Leg	MODEL	COM/COL	A	B	C	D	E	F	G	H	I	J	K	L
3D Beech veneer shell, upholstered seat onlay W 22.5 D 21.5 H 31 SH 18.25	SLW-3BU	\$1436	1497	1529	1560	1591	1623	1654	1685	1717	1748	1780	1811	1842

COM Yardage: 1 or 2 seats: .75 yard
 Contact Leland Customer Experience for yardage requirements on textiles with repeats.
 For COL requirements please contact Leland Customer Experience.

To specify:
 Please refer to pages 3-4 for complete specifying information.
 Specify all products by their product code.

Pricing Effective: July 2021

SLAM 4-LEG MOBILE BASE CHAIR
 Design: Lievore Altherr Molina, licensed by Sellex

SL10



Slam Stacking

4-Leg Mobile Base Chair

	MODEL	FRAME FINISH	LIST PRICE
Polypropylene shell w/ casters	SLM-PO	Powder Coat	\$681
W 20.75 D 19.75 H 31 .75 SH 18.25		Chrome	\$740



Slam

4-Leg Mobile Base Chair

	MODEL	LIST PRICE/ GRADE	COM/COL	A	B	C	D	E	F	G	H	I	J	K	L
Polypropylene shell, upholstered seat onlay, w/ casters	SLM-PU	Powder Coat	\$814	875	907	938	970	1001	1032	1064	1095	1126	1158	1189	1220
		Chrome	\$871	933	933	995	1027	1058	1090	1121	1152	1184	1215	1246	1278

W 20.75 D 19.75 H 31 .75
SH 18.5

COM Yardage: 1 or 2 seats: .75 yard
 Contact Leland Customer Experience for yardage requirements on textiles with repeats.
 For COL requirements please contact Leland Customer Experience.



Slam

4-Leg Mobile Base Chair

	MODEL	LIST PRICE/ GRADE	COM/COL	A	B	C	D	E	F	G	H	I	J	K	L
Fully upholstered w/ casters	SLM-FU	Powder Coat	\$957	1066	1120	1175	1230	1284	1339	1392	1447	1502	1556	1611	1665
		Chrome	\$1016	1126	1180	1235	1289	1344	1399	1453	1508	1562	1616	1671	1725

W 20.75 D 19.75 H 31 .75
SH 18.5

COM Yardage: 1 seat: 1.5 yards
 Contact Leland Customer Experience for yardage requirements on textiles with repeats.
 For COL requirements please contact Leland Customer Experience.

To specify:
 Please refer to pages 3-4 for
 complete specifying information.
 Specify all products by their
 product code.

Pricing Effective: July 2021

SLAM 4-LEG MOBILE BASE CHAIR
 Design: Lievore Altherr Molina, licensed by Sellex

SL11



Slam Stacking

4-Leg Mobile Base Chair	MODEL	FRAME FINISH	LIST PRICE
3D Beech veneer shell w/ casters	SLM-3DB	Powder Coat	\$1234
		Chrome	\$1295
W 20.75 D 19.75 H 31.75 SH 18.25			



Slam

4-Leg Mobile Base Chair	MODEL	LIST PRICE/ GRADE	COM/COL	A	B	C	D	E	F	G	H	I	J	K	L
3D Beech veneer shell, upholstered seat onlay, w/ casters	SLM-3BU	Powder Coat	\$1366	1428	1459	1491	1522	1554	1585	1616	1648	1679	1710	1742	1773
		Chrome	\$1426	1488	1519	1550	1582	1613	1644	1676	1707	1738	1770	1801	1833
W 20.75 D 19.75 H 31.75 SH 18.5				COM Yardage: 1 or 2 seats: .75 yard Contact Leland Customer Experience for yardage requirements on textiles with repeats. For COL requirements please contact Leland Customer Experience.											



Slam Stacking

4-Leg Mobile Base Chair	MODEL	FRAME FINISH	LIST PRICE
3D Oak veneer shell w/ casters	SLM-3D0	Powder Coat	\$1387
		Chrome	\$1448
W 20.75 D 19.75 H 31.75 SH 18.25			



Slam

4-Leg Mobile Base Chair	MODEL	LIST PRICE/ GRADE	COM/COL	A	B	C	D	E	F	G	H	I	J	K	L
3D Beech veneer shell, upholstered seat onlay, w/ casters	SLM-30U	Powder Coat	\$1519	1581	1612	1643	1675	1706	1737	1769	1800	1831	1863	1894	1926
		Chrome	\$1579	1641	1672	1704	1735	1767	1798	1829	1861	1892	1923	1955	1986
W 20.75 D 19.75 H 31.75 SH 18.5				CCOM Yardage: 1 or 2 seats: .75 yard Contact Leland Customer Experience for yardage requirements on textiles with repeats. For COL requirements please contact Leland Customer Experience.											

To specify:
 Please refer to pages 3-4 for complete specifying information.
 Specify all products by their product code.

Pricing Effective: July 2021

SLAM SIDE CHAIR, ALUMINUM BASE
 Design: Lievore Altherr Molina, licensed by Sellex

SL12



Slam Side Chair

Aluminum Base

	MODEL	FRAME FINISH	LIST PRICE
Polypropylene shell	SLA-PO	Powder Coat	\$701
W 20.75 D 20.75 H 31.75 SH 18		Polished Aluminum	\$1233



Slam Side Chair

Aluminum Base

	MODEL	LIST PRICE/GRADE	COM/COL	A	B	C	D	E	F	G	H	I	J	K	L
Polypropylene shell upholstered seat onlay	SLA-PU	Powder Coat	\$833	895	926	958	989	1020	1052	1083	1114	1146	1177	1209	1240
		Polished Aluminum	\$1365	1427	1458	1490	1490	1552	1584	1615	1647	1678	1709	1741	1772
W 20.75 D 20.75 H 31.75 SH 18.25			COM Yardage: 1 or 2 seats: .75 yard Contact Leland Customer Experience for yardage requirements on textiles with repeats.												



Slam Side Chair

Aluminum Base

	MODEL	LIST PRICE/GRADE	COM/COL	A	B	C	D	E	F	G	H	I	J	K	L
Fully upholstered	SLA-FU	Powder Coat	\$977	1085	1139	1194	1248	1303	1358	1412	1467	1521	1576	1630	1684
W 20.75 D 20.75 H 31.75 SH 18.25		Polished Aluminum	\$1534	1642	1697	1751	1806	1861	1915	1970	2024	2079	2134	2187	2242
			COM Yardage: 1 seat: 1.5 yards Contact Leland Customer Experience for yardage requirements on textiles with repeats.												

To specify:

Please refer to pages 3-4 for complete specifying information.
 Specify all products by their product code.

Pricing Effective: July 2021

SLAM SIDE CHAIR, ALUMINUM BASE
 Design: Lievore Altherr Molina, licensed by Sellex

SL13



Slam Side Chair

Aluminum Base

	MODEL	FRAME FINISH	LIST PRICE
3D Beech veneer shell, aluminum base	SLA-3DB	Powder Coat	\$1256
		Polished Aluminum	\$1786

W 20.75 D 20.75
H 31.75 SH 18



Slam Side Chair

Aluminum Base

	MODEL	LIST PRICE/GRADE	COM/COL	A	B	C	D	E	F	G	H	I	J	K	L
3D Beech veneer shell, upholstered seat onlay, aluminum base	SLA-3BU	Powder Coat	\$1386	1448	1479	1510	1542	1573	1604	1636	1667	1698	1730	1761	1793
		Polished Aluminum	\$1918	1980	2011	2042	2074	2105	2136	2168	2199	2231	2262	2293	2325

W 20.75 D 20.75
H 31.75 SH 18.25

Optional Glides: Add \$8.00 net per chair for a set of four (4). Optional Glides raise chair height .5 inch.
 COM Yardage: 1 or 2 seats: .75 yard
 Contact Leland Customer Experience for yardage requirements on textiles with repeats.



Slam Side Chair

Aluminum Base

	MODEL	FRAME FINISH	LIST PRICE
3D Oak veneer shell, aluminum base	SLA-3DO	Powder Coat	\$1409
		Polished Aluminum	\$1939

W 20.75 D 20.75
H 31.75 SH 18



Slam Side Chair

Aluminum Base

	MODEL	LIST PRICE/GRADE	COM/COL	A	B	C	D	E	F	G	H	I	J	K	L
3D Oak veneer shell, upholstered seat onlay, aluminum base	SLA-3OU	Powder Coat	\$1538	1600	1631	1663	1694	1725	1757	1788	1820	1851	1882	1914	1945
		Polished Aluminum	\$2070	2132	2163	2195	2226	2258	2289	2320	2352	2383	2414	2446	2477

W 20.75 D 20.75
H 31.75 SH 18.25

Optional Glides: Add \$8.00 net per chair for a set of four (4). Optional Glides raise chair height .5 inch.
 COM Yardage: 1 or 2 seats: .75 yard
 Contact Leland Customer Experience for yardage requirements on textiles with repeats.

To specify:

Please refer to pages 3-4 for complete specifying information. Specify all products by their product code.

SLAM ARM CHAIR, ALUMINUM BASE
 Design: Lievore Altherr Molina, licensed by Sellex

SL14



Slam Arm Chair

Aluminum Base

	MODEL	FRAME FINISH	LIST PRICE
Polypropylene shell	SLAA-PO	Powder Coat	\$784
W 25 D 20.75 H 31.75 SH 18 AH 25.5		Polished Aluminum	\$1362



Slam Arm Chair

Aluminum Base

	MODEL	LIST PRICE/GRADE	COM/COL	A	B	C	D	E	F	G	H	I	J	K	L
Polypropylene shell upholstered seat onlay	SLAA-PU	Powder Coat	\$915	977	1008	1040	1071	1103	1134	1165	1197	1228	1259	1291	1322
		Polished Aluminum	\$1491	1552	1584	1615	1647	1678	1709	1741	1772	1803	1835	1866	1897
W 25 D 20.75 H 31.75 SH 18.25 AH 25.5			COM Yardage: 1 or 2 seats: .75 yard Contact Leland Customer Experience for yardage requirements on textiles with repeats.												



Slam Arm Chair

Aluminum Base

	MODEL	LIST PRICE/GRADE	COM/COL	A	B	C	D	E	F	G	H	I	J	K	L
Fully upholstered	SLAA-FU	Powder Coat	\$1063	1172	1225	1280	1335	1389	1444	1498	1553	1608	1662	1717	1771
W 25 D 20.75 H 31.75 SH 18.25 AH 25.5		Polished Aluminum	\$1668	1778	1832	1887	1941	1996	2051	2105	2159	2213	2268	2323	2377
			COM Yardage: 1.5 yards Contact Leland Customer Experience for yardage requirements on textiles with repeats.												

To specify:
 Please refer to pages 3-4 for complete specifying information.
 Specify all products by their product code.

Pricing Effective: July 2021

SLAM ARM CHAIR, ALUMINUM BASE
 Design: Lievore Altherr Molina, licensed by Sellex

SL15



Slam Arm Chair

Aluminum Base	MODEL	FRAME FINISH	LIST PRICE
3D Beech veneer shell	SLAA-3DB	Powder Coat	\$1337
W 25 D 20.75 H 31.75 SH 18 AH 25.5		Polished Aluminum	\$1914



Slam Arm Chair

Aluminum Base	MODEL	LIST PRICE/GRADE	COM/COL	A	B	C	D	E	F	G	H	I	J	K	L
3D Beech veneer shell, upholstered seat onlay, aluminum base	SLAA-3BU	Powder Coat	\$1468	1530	1561	1592	1624	1655	1687	1718	1749	1781	1812	1843	1875
		Polished Aluminum	\$2045	2106	2138	2169	2200	2232	2263	2294	2326	2357	2388	2420	2451
W 25 D 20.75 H 31.75 SH 18.25 AH 25.5		Optional Glides: Add \$8.00 net per chair for a set of four (4). Optional Glides raise chair height .5 inch. COM Yardage: 1 or 2 seats: .75 yard Contact Leland Customer Experience for yardage requirements on textiles with repeats.													



Slam Arm Chair

Aluminum Base	MODEL	FRAME FINISH	LIST PRICE
3D Oak veneer shell, aluminum base	SLAA-3DO	Powder Coat	\$1490
W 25 D 20.75 H 31.75 SH 18 AH 25.5		Polished Aluminum	\$2065



Slam Arm Chair

Aluminum Base	MODEL	LIST PRICE/GRADE	COM/COL	A	B	C	D	E	F	G	H	I	J	K	L
3D Oak veneer shell, upholstered seat onlay, aluminum base	SLAA-3OU	Powder Coat	\$1621	1682	1714	1745	1776	1808	1839	1870	1902	1933	1965	1996	2027
		Polished Aluminum	\$2197	2259	2290	2321	2353	2384	2415	2447	2478	2510	2541	2572	2604
W 25 D 20.75 H 31.75 SH 18.25 AH 25.5		Optional Glides: Add \$8.00 net per chair for a set of four (4). Optional Glides raise chair height .5 inch. COM Yardage: 1 or 2 seats: .75 yard Contact Leland Customer Experience for yardage requirements on textiles with repeats.													

To specify:
 Please refer to pages 3-4 for complete specifying information.
 Specify all products by their product code.

Pricing Effective: July 2021

SLAM TASK BASE CHAIR
 Design: Lievore Altherr Molina, licensed by Sellex

SL16

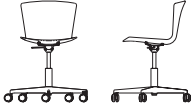

Slam Task Base Chair	MODEL	FRAME FINISH	LIST PRICE
Polypropylene shell	SLTB-PO	Powder Coat	\$790
W 20.75 D 20.75 H 31.75 SH 18.25		Task Base comes with universal hard and soft floor casters.	



Slam Task Base Chair	MODEL	LIST PRICE/GRADE	COM/COL	A	B	C	D	E	F	G	H	I	J	K	L
Polypropylene shell, upholstered seat onlay	SLTB-PU	Powder Coat	\$920	959	978	998	1017	1037	1056	1076	1095	1114	1134	1153	1173
W 20.75 D 20.75 H 31.75 SH 18.5		COM Yardage: 1 or 2 seats: .75 yard Contact Leland Customer Experience for yardage requirements on textiles with repeats. Task Base comes with universal hard and soft floor casters.													

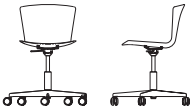

Slam Task Base Chair	MODEL	LIST PRICE/GRADE	COM/COL	A	B	C	D	E	F	G	H	I	J	K	L
Fully upholstered	SLTB-FU	Powder Coat	\$1068	1177	1232	1286	1341	1395	1449	1504	1558	1613	1667	1722	1777
W 20.75 D 20.75 H 31.75 SH 18.5		COM Yardage: 1 seat: 1.5 yards Contact Leland Customer Experience for yardage requirements on textiles with repeats. Task Base comes with universal hard and soft floor casters.													

To specify:
 Please refer to pages 3-4 for complete specifying information.
 Specify all products by their product code.

Pricing Effective: July 2021

SLAM TASK BASE CHAIR
 Design: Lievore Altherr Molina, licensed by Sellex

SL17

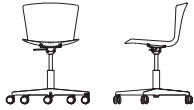

Slam Task Base Chair	MODEL	FRAME FINISH	LIST PRICE
3D Beech veneer shell	SLTB-3DB	Powder Coat	\$1342
W 20.75 D 20.75 H 31.75 SH 18.25		Task Base comes with universal hard and soft floor casters.	

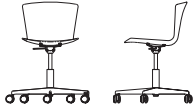

Slam Task Base Chair	MODEL	LIST PRICE/GRADE	COM/COL	A	B	C	D	E	F	G	H	I	J	K	L
3D Beech veneer shell, upholstered seat onlay	SLTB-3BU	Powder Coat	\$1475	1514	1533	1552	1572	1591	1611	1630	1650	1669	1689	1708	1728
W 20.75 D 20.75 H 31.75 SH 18.5		COM Yardage: 1 or 2 seats: .75 yard Contact Leland Customer Experience for yardage requirements on textiles with repeats. Task Base comes with universal hard and soft floor casters.													



Slam Task Base Chair	MODEL	FRAME FINISH	LIST PRICE
3D Oak veneer shell	SLTB-3DO	Powder Coat	\$1494
W 20.75 D 20.75 H 31.75 SH 18.25		Task Base comes with universal hard and soft floor casters.	



Slam Task Base Chair	MODEL	LIST PRICE/GRADE	COM/COL	A	B	C	D	E	F	G	H	I	J	K	L
3D Oak veneer shell, upholstered seat onlay	SLTB-3OU	Powder Coat	\$1627	1666	1685	1705	1724	1744	1763	1783	1802	1822	1841	1861	1880
W 20.75 D 20.75 H 31.75 SH 18.5		COM Yardage: 1 or 2 seats: .75 yard Contact Leland Customer Experience for yardage requirements on textiles with repeats. Task Base comes with universal hard and soft floor casters.													

To specify:
 Please refer to pages 3-4 for complete specifying information.
 Specify all products by their product code.

Pricing Effective: July 2021

SLAM SLED COUNTER CHAIR
 Design: Lievore Altherr Molina, licensed by Sellex

SL18



Slam Sled Counter Chair

	MODEL	FRAME FINISH	LIST PRICE
Polypropylene shell	SLCS-PO	Powder Coat	\$630
W 22 D 20.75 H 39 SH 25		Chrome	\$701

Optional Glides: Add \$8.00 net per chair for a set of four (4).



Slam Sled Counter Chair

	MODEL	LIST PRICE/GRADE	COM/COL	A	B	C	D	E	F	G	H	I	J	K	L
Polypropylene shell, upholstered seat onlay,	SLCS-PU	Powder Coat	\$763	825	856	887	919	950	981	1013	1044	1076	1107	1138	1170
		Chrome	\$833	895	926	958	989	1020	1052	1083	1114	1146	1177	1209	1240

W 22 D 20.75
 H 39 SH 25.25

COM Yardage: 1 or 2 seats: .75 yard
 Contact Leland Customer Experience for yardage requirements on textiles with repeats.
 Optional Glides: Add \$8.00 net per chair for a set of four (4).



Slam Sled Counter Chair

	MODEL	LIST PRICE/GRADE	COM/COL	A	B	C	D	E	F	G	H	I	J	K	L
Fully upholstered	SLCS-FU	Powder Coat	\$902	1011	1066	1120	1175	1230	1284	1339	1392	1447	1502	1556	1611
		Chrome	\$977	1085	1139	1194	1248	1303	1358	1412	1467	1521	1576	1630	1684

W 22 D 20.75
 H 39 SH 25.25

COM Yardage: 1.5 yards
 Contact Leland Customer Experience for yardage requirements on textiles with repeats.
 Optional Glides: Add \$8.00 net per chair for a set of four (4).

To specify:
 Please refer to pages 3-4 for complete specifying information.
 Specify all products by their product code.

Pricing Effective: July 2021

SLAM SLED COUNTER CHAIR
 Design: Lievore Altherr Molina, licensed by Sellex

SL19



Slam Sled

Counter Chair	MODEL	FRAME FINISH	LIST PRICE
3D Beech veneer shell	SLCS-3DB	Powder Coat	\$1185
W 22 D 20.75 H 39 SH 25		Chrome	\$1256

Optional Glides: Add \$8.00 net per chair for a set of four (4).



Slam Sled

Counter Chair	MODEL	LIST PRICE/GRADE	COM/COL	A	B	C	D	E	F	G	H	I	J	K	L
3D Beech veneer shell, upholstered seat onlay	SLCS-3BU	Powder Coat	\$1313	1375	1406	1438	1469	1501	1532	1563	1595	1626	1657	1689	1720
		Chrome	\$1386	1448	1479	1510	1542	1573	1604	1636	1667	1698	1730	1761	1793

W 22 D 20.75
 H 39 SH 25.25

COM Yardage: 1 or 2 seats: .75 yard
 Contact Leland Customer Experience for yardage requirements on textiles with repeats.
 Optional Glides: Add \$8.00 net per chair for a set of four (4).



Slam Sled

Counter Chair	MODEL	FRAME FINISH	LIST PRICE
3D Oak veneer shell	SLCS-3DO	Powder Coat	\$1337
W 22 D 20.75 H 39 SH 25		Chrome	\$1409

Optional Glides: Add \$8.00 net per chair for a set of four (4).



Slam Sled

Counter Chair	MODEL	LIST PRICE/GRADE	COM/COL	A	B	C	D	E	F	G	H	I	J	K	L
3D Oak veneer shell, upholstered seat onlay	SLCS-3OU	Powder Coat	\$1466	1528	1559	1590	1622	1653	1684	1716	1747	1747	1810	1841	1873
		Chrome	\$1538	1600	1631	1663	1694	1725	1757	1788	1820	1851	1882	1914	1945

W 22 D 20.75
 H 39 SH 25.25

COM Yardage: 1 or 2 seats: .75 yard
 Contact Leland Customer Experience for yardage requirements on textiles with repeats.
 Optional Glides: Add \$8.00 net per chair for a set of four (4).

To specify:
 Please refer to pages 3-4 for complete specifying information.
 Specify all products by their product code.

SLAM 4-LEG COUNTER CHAIR
 Design: Lievore Altherr Molina, licensed by Sellex

SL20



Slam 4-Leg Counter Chair

	MODEL	FRAME FINISH	LIST PRICE
Polypropylene shell	SLC4-PO	Powder Coat	\$824
W 22 D 19.75 H 37 SH 25		Chrome	\$892

Optional Glides: Add \$8.00 net per chair for a set of four (4). Optional Glides raise chair height .5 inch.



Slam 4-Leg Counter Chair

	MODEL	LIST PRICE/GRADE	COM/COL	A	B	C	D	E	F	G	H	I	J	K	L
Polypropylene shell, upholstered seat onlay	SLC4-PU	Powder Coat	\$954	1016	1047	1079	1110	1141	1173	1204	1236	1267	1298	1330	1361
		Chrome	\$1024	1085	1117	1148	1179	1211	1242	1273	1305	1336	1368	1399	1430

W 22 D 19.75
 H 37.25 SH 25.25

Optional Glides: Add \$8.00 net per chair for a set of four (4). Optional Glides raise chair height .5 inch.
 COM Yardage: 1 or 2 seats: .75 yard
 Contact Leland Customer Experience for yardage requirements on textiles with repeats.
 For COL requirements please contact Leland Customer Experience.



Slam 4-Leg Counter Chair

	MODEL	LIST PRICE/GRADE	COM/COL	A	B	C	D	E	F	G	H	I	J	K	L
Fully upholstered	SLC4-FU	Powder Coat	\$1103	1211	1265	1320	1374	1429	1484	1538	1593	1647	1702	1756	1810
		Chrome	\$1175	1284	1339	1392	1447	1502	1556	1611	1665	1720	1775	1829	1884

W 22 D 19.75
 H 37.25 SH 25.25

Optional Glides: Add \$8.00 net per chair for a set of four (4). Optional Glides raise chair height .5 inch.
 COM Yardage: 1.5 yards
 Contact Leland Customer Experience for yardage requirements on textiles with repeats.
 For COL requirements please contact Leland Customer Experience.

To specify:
 Please refer to pages 3-4 for complete specifying information.
 Specify all products by their product code.

Pricing Effective: July 2021

SLAM 4-LEG COUNTER CHAIR
 Design: Lievore Altherr Molina, licensed by Sellex

SL21



Slam 4-Leg Counter Chair

	MODEL	FRAME FINISH	LIST PRICE
3D Beech veneer shell	SLC4-3DB	Powder Coat	\$1377
W 22 D 19.75 H 37 SH 25		Chrome	\$1445

Optional Glides: Add \$8.00 net per chair for a set of four (4). Optional Glides raise chair height .5 inch.



Slam 4-Leg Counter Chair

	MODEL	LIST PRICE/GRADE	COM/COL	A	B	C	D	E	F	G	H	I	J	K	L
3D Beech veneer shell, upholstered seat onlay	SLC4-3BU	Powder Coat	\$1507	1569	1600	1631	1663	1694	1725	1757	1788	1820	1851	1882	1914
		Chrome	\$1576	1638	1669	1701	1732	1763	1795	1826	1857	1889	1920	1952	1983

W 22 D 19.75
 H 37.25 SH 25.25

Optional Glides: Add \$8.00 net per chair for a set of four (4). Optional Glides raise chair height .5 inch.
 COM Yardage: 1 or 2 seats: .75 yard
 Contact Leland Customer Experience for yardage requirements on textiles with repeats.
 For COL requirements please contact Leland Customer Experience.



Slam 4-Leg Counter Chair

	MODEL	FRAME FINISH	LIST PRICE
3D Oak veneer shell	SLC4-3DO	Powder Coat	\$1530
W 22 D 19.75 H 37 SH 25		Chrome	\$1598

Optional Glides: Add \$8.00 net per chair for a set of four (4). Optional Glides raise chair height .5 inch.



Slam 4-Leg Counter Chair

	MODEL	LIST PRICE/GRADE	COM/COL	A	B	C	D	E	F	G	H	I	J	K	L
3D Oak veneer shell, upholstered seat onlay	SLC4-3OU	Powder Coat	\$1660	1721	1753	1784	1815	1847	1878	1909	1941	1972	2003	2035	2066
		Chrome	\$1730	1791	1823	1854	1886	1917	1948	1978	2011	2042	2074	2105	2136

W 22 D 19.75
 H 37.25 SH 25.25

Optional Glides: Add \$8.00 net per chair for a set of four (4). Optional Glides raise chair height .5 inch.
 COM Yardage: 1 or 2 seats: .75 yard
 Contact Leland Customer Experience for yardage requirements on textiles with repeats.
 For COL requirements please contact Leland Customer Experience.

To specify:
 Please refer to pages 3-4 for complete specifying information.
 Specify all products by their product code.

SLAM SLED BAR CHAIR
 Design: Lievore Altherr Molina, licensed by Sellex

SL22



Slam Sled Bar Chair	MODEL	FRAME FINISH	LIST PRICE
Polypropylene shell W 22 D 20.75 H 43 SH 30	SLBS-PO	Powder Coat	\$710
		Chrome	\$772

Optional Glides: Add \$8.00 net per chair for a set of four (4).



Slam Sled Bar Chair	MODEL	LIST PRICE/GRADE	COM/COL	A	B	C	D	E	F	G	H	I	J	K	L
Polypropylene shell, upholsteredseat onlay W 22 D 20.75 H 43 SH 30.25	SLBS-PU	Powder Coat	\$790	852	883	914	946	977	1008	1040	1071	1103	1134	1165	1197
		Chrome	\$851	912	944	975	1006	1038	1069	1100	1132	1163	1194	1226	1257

COM Yardage: 1 or 2 seats: .75 yard
 Contact Leland Customer Experience for yardage requirements on textiles with repeats.
 Optional Glides: Add \$8.00 net per chair for a set of four (4).



Slam Sled Bar Chair	MODEL	LIST PRICE/GRADE	COM/COL	A	B	C	D	E	F	G	H	I	J	K	L
Fully upholstered W 22 D 20.75 H 43 SH 30.25	SLBS-FU	Powder Coat	\$931	1041	1095	1150	1204	1259	1314	1368	1423	1476	1531	1586	1640
		Chrome	\$993	1103	1156	1211	1265	1320	1374	1429	1484	1538	1593	1647	1702

COM Yardage: 1.5 yards
 Contact Leland Customer Experience for yardage requirements on textiles with repeats.
 Optional Glides: Add \$8.00 net per chair for a set of four (4).

To specify:
 Please refer to pages 3-4 for complete specifying information.
 Specify all products by their product code.

Pricing Effective: July 2021

SLAM SLED BAR CHAIR

Design: Lievore Altherr Molina, licensed by Sellex

SL23



Slam Sled Bar Chair	MODEL	FRAME FINISH	LIST PRICE
3D Beech veneer shell	SLBS-3DB	Powder Coat	\$1264
W 22 D 20.75 H 43 SH 30		Chrome	\$1326
Optional Glides: Add \$8.00 net per chair for a set of four (4).			



Slam Sled Bar Chair	MODEL	LIST PRICE/GRADE	COM/COL	A	B	C	D	E	F	G	H	I	J	K	L
3D Beech veneer shell, upholstered seat onlay	SLBS-3BU	Powder Coat	\$1395	1456	1488	1519	1550	1582	1613	1644	1676	1707	1738	1770	1801
W 22 D 20.75 H 43 SH 30.25		Chrome	\$1558	1620	1651	1682	1714	1745	1776	1808	1839	1870	1902	1933	1965
COM Yardage: 1 or 2 seats: .75 yard															
Contact Leland Customer Experience for yardage requirements on textiles with repeats.															
Optional Glides: Add \$8.00 net per chair for a set of four (4).															



Slam Sled Bar Chair	MODEL	FRAME FINISH	LIST PRICE
3D Oak veneer shell	SLBS-3DO	Powder Coat	\$1416
W 22 D 20.75 H 43 SH 30		Chrome	\$1479
Optional Glides: Add \$8.00 net per chair for a set of four (4).			



Slam Sled Bar Chair	MODEL	LIST PRICE/GRADE	COM/COL	A	B	C	D	E	F	G	H	I	J	K	L
3D Oak veneer shell, upholstered seat onlay	SLBS-3OU	Powder Coat	\$1547	1609	1640	1671	1703	1734	1766	1797	1828	1860	1891	1922	1954
W 22 D 20.75 H 43 SH 30.25		Chrome	\$1405	1467	1498	1530	1561	1592	1624	1655	1687	1718	1749	1781	1812
COM Yardage: 1 or 2 seats: .75 yard															
Contact Leland Customer Experience for yardage requirements on textiles with repeats.															
Optional Glides: Add \$8.00 net per chair for a set of four (4).															

To specify:
Please refer to pages 3-4 for complete specifying information.
Specify all products by their product code.

Pricing Effective: July 2021

SLAM 4-LEG BAR CHAIR
 Design: Lievore Altherr Molina, licensed by Sellex

SL24



Slam 4-Leg Bar Chair	MODEL	FRAME FINISH	LIST PRICE
Polypropylene shell	SLB4-PO	Powder Coat	\$840
W 22 D 19.75 H 43 SH 30		Chrome	\$911
Optional Glides: Add \$8.00 net per chair for a set of four (4).			



Slam 4-Leg Bar Chair	MODEL	LIST PRICE/GRADE	COM/COL	A	B	C	D	E	F	G	H	I	J	K	L
Polypropylene shell, upholsteredseat onlay	SLB4-PU	Powder Coat	\$971	1032	1064	1095	1126	1158	1189	1220	1252	1283	1315	1346	1377
W 22 D 19.75 H 43.25 SH 30.25		Chrome	\$1040	1101	1133	1164	1196	1227	1258	1290	1321	1352	1384	1415	1446
Optional Glides: Add \$8.00 net per chair for a set of four (4). Optional Glides raise chair height .5 inch. COM Yardage: 1 or 2 seats: .75 yard Contact Leland Customer Experience for yardage requirements on textiles with repeats. For COL requirements please contact Leland Customer Experience.															



Slam 4-Leg Bar Chair	MODEL	LIST PRICE/GRADE	COM/COL	A	B	C	D	E	F	G	H	I	J	K	L
Fully upholstered	SLB4-FU	Powder Coat	\$1121	1231	1285	1340	1394	1448	1503	1557	1612	1666	1721	1776	1830
W 22 D 19.75 H 43.25 SH 30.25		Chrome	\$1194	1303	1358	1412	1467	1521	1576	1630	1684	1739	1793	1848	1903
Optional Glides: Add \$8.00 net per chair for a set of four (4). Optional Glides raise chair height .5 inch. COM Yardage: 1.5 yards Contact Leland Customer Experience for yardage requirements on textiles with repeats. For COL requirements please contact Leland Customer Experience.															

To specify:
 Please refer to pages 3-4 for complete specifying information.
 Specify all products by their product code.

Pricing Effective: July 2021

SLAM SLED BAR CHAIR

Design: Lievore Altherr Molina, licensed by Sellex

SL25



Slam 4-Leg Bar Chair	MODEL	FRAME FINISH	LIST PRICE
3D Beech veneer shell W 22 D 19.75 H 43 SH 30	SLB4-3DB	Powder Coat	\$1391
		Chrome	\$1462

Optional Glides: Add \$8.00 net per chair for a set of four (4). Optional Glides raise chair height .5 inch.



Slam 4-Leg Bar Chair	MODEL	LIST PRICE/GRADE	COM/COL	A	B	C	D	E	F	G	H	I	J	K	L
3D Beech veneer shell, upholstered seat onlay W 22 D 19.75 H 43.25 SH 30.25	SLB4-3BU	Powder Coat	\$1525	1587	1618	1650	1681	1713	1744	1775	1807	1838	1869	1901	1932
		Chrome	\$1594	1655	1687	1718	1749	1781	1812	1843	1875	1906	1937	1969	2000

Optional Glides: Add \$8.00 net per chair for a set of four (4). Optional Glides raise chair height .5 inch.
COM Yardage: 1 or 2 seats: .75 yard
Contact Leland Customer Experience for yardage requirements on textiles with repeats.
For COL requirements please contact Leland Customer Experience.



Slam 4-Leg Bar Chair	MODEL	FRAME FINISH	LIST PRICE
3D Oak veneer shell W 22 D 19.75 H 43 SH 30	SLB4-3DO	Powder Coat	\$1545
		Chrome	\$1614

Optional Glides: Add \$8.00 net per chair for a set of four (4). Optional Glides raise chair height .5 inch.



Slam 4-Leg Bar Chair	MODEL	LIST PRICE/GRADE	COM/COL	A	B	C	D	E	F	G	H	I	J	K	L
3D Oak veneer shell, upholstered seat onlay W 22 D 19.75 H 43.25 SH 30.25	SLB4-3OU	Powder Coat	\$1678	1740	1771	1802	1834	1865	1896	1928	1959	1990	2022	2053	2085
		Chrome	\$1746	1808	1839	1870	1902	1933	1965	1996	2027	2059	2090	2121	2153

Optional Glides: Add \$8.00 net per chair for a set of four (4). Optional Glides raise chair height .5 inch.
COM Yardage: 1 or 2 seats: .75 yard
Contact Leland Customer Experience for yardage requirements on textiles with repeats.
For COL requirements please contact Leland Customer Experience..

To specify:
Please refer to pages 3-4 for complete specifying information.
Specify all products by their product code.

Pricing Effective: July 2021

SLAM TRANSPORT/STACKING DOLLY
 Design: Lievore Altherr Molina, licensed by Sellex

SL26

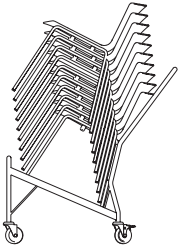

**Slam Transport/
Stacking Dolly**

	MODEL	LIST PRICE
Black powder coat finish	SLD	\$1812
W 25 D 41.25 H 42 (Dimensions of dolly when empty)		
W 26 D 45 H 55 (Dimensions with stack)		

Slam Transport/Stacking Dolly capacity:
 4-Leg Base: 10 high on dolly (8 high on floor)
 4-Leg Mobile Base: 8 high on dolly (4 high on floor)
 **Sled and Aluminum Base does not stack

To specify:
 Please refer to pages 3-4 for complete specifying information.
 Specify all products by their product code.

Pricing Effective: July 2021

SLAM LOUNGE CHAIR

Design: Lievore Altherr Molina, licensed by Sellex

SL27



Slam Lounge

Sled Base

	MODEL	LIST PRICE/GRADE	COM/COL	A	B	C	D	E	F	G	H	I	J	K	L
Fully upholstered	SLL-S	Powder Coat	\$1014	1096	1141	1188	1233	1278	1323	1369	1414	1460	1505	1551	1596
W 27.5 D 27.5 H 30 SH 17		Chrome	\$1079	1161	1206	1252	1298	1343	1388	1433	1479	1525	1570	1615	1661

Optional Glides: Add \$8.00 net per chair for a set of four (4). Optional Glides raise chair height .5 inch.

COM Yardage: 1 seat: 1.75 yard

Contact Leland Customer Experience for yardage requirements on textiles with repeats.

For COL requirements please contact Leland Customer Experience.



Slam Lounge

Pyramidal Base

	MODEL	LIST PRICE/GRADE	COM/COL	A	B	C	D	E	F	G	H	I	J	K	L
Fully upholstered	SLL-P	Powder Coat	\$1472	1554	1599	1645	1691	1736	1781	1827	1872	1917	1962	2009	2054
W 27.5 D 26 H 30 SH 17		Polished Aluminun	\$2031	2113	2158	2204	2249	2294	2339	2386	2431	2476	2521	2567	2612

Optional Glides: Add \$8.00 net per chair for a set of four (4). Optional Glides raise chair height .5 inch.

COM Yardage: 1 seat: 1.75 yard

Contact Leland Customer Experience for yardage requirements on textiles with repeats.

For COL requirements please contact Leland Customer Experience.

To specify:

Please refer to pages 3-4 for complete specifying information.

Specify all products by their product code.

Pricing Effective: July 2021

5695 Eagle Drive, SE
Grand Rapids,
Michigan 49512
616-975-9260
lelandfurniture.com

Slam Beam

July 2021 Price List



Slam Beam

Table of Contents	SB2
Configurative Overview	SB3
Order Diagram	SB4
Visual Reference	SB5
Specification Information	SB8
Specification Example	SB9
Base, Two Position	SB10
Base, Three Position	SB11
Base, Four Position	SB12
Shell Specification Information	SB13
Specification Example	SB14
Shell Selection	SB15
Table Specification Information	SB17
Table Specification Example	SB18
Table	SB19
Floor Mount	SB20

Slam Beam Seating Configuration

Slam Beam can be configured in many ways to meet the needs of your public space. The following pages will provide you a step by step process to correctly configure your benches. **Each purchase order submitted requires the diagram on page SB17 of this price list to be completed for every different bench model.** This is to ensure that the product you receive is exactly what you intended to purchase. If Leland can be of any assistance to you, please don't hesitate to contact our Customer Experience Department at 800-859-7510.

1. Base Selection

Begin configuring Slam Beam by selecting a base. Bases are available in three or four positions, either with arms or armless.

2. Shell Added to Base

The Slam shell is designed to fit one base position. Shells are available in polypropylene or 3D Veneer with or without upholstery. When placing an order, each shell is considered a separate product and will require its own model number.

3. Table Added to Base (Optional)

Slam Beam tables fit one base position. Table surface selections are available as a laminate. When placing an order, each table is considered a separate product and will require its own model number.

Please complete and include with your order. If multiple units are ordered, a diagram must be completed for each unique unit.

1. Slam Beam Base Selection

Select a three position or four position base model number:

The gray boxes below represent the seat/table positions of the model. Specify from left to right as seated. *Note diagram (bottom is front of bench).

TWO (2) POSITION

SB2NA, two position, armless

SB22A, two position, two arm

SB23A, two position, three arm

THREE (3) POSITION

SB3NA, three position, armless

SB32A, three position, two arm

SB34A, three position, four arm

FOUR (4) POSITION

SB4NA, four position, armless

SB42A, four position, two arm

SB45A, four position, five arm

2. SLAM BEAM SHELL AND TABLE SELECTION

Please select either a shell or a table for each position on your base. Then choose the surface materials. Positions should be specified from left to right as seated.

POSITION ONE POSITION TWO

Shell

Polypropylene

Polypropylene

w/ Uph. Seat Onlay

Fully Uph.

Oak 3D Veneer

Oak 3D Veneer w/

Uph. Seat Onlay

Tables

POSITION THREE

Shell

Polypropylene

Polypropylene

w/ Uph. Seat Onlay

Fully Uph.

Oak 3D Veneer

Oak 3D Veneer w/

Uph. Seat Onlay

Tables

POSITION FOUR

Shell

Polypropylene

Polypropylene

w/ Uph. Seat Onlay

Fully Uph.

Oak 3D Veneer

Oak 3D Veneer w/

Uph. Seat Onlay

Tables

POSITION FOUR

Shell

Polypropylene

Polypropylene

w/ Uph. Seat Onlay

Fully Uph.

Oak 3D Veneer

Oak 3D Veneer w/

Uph. Seat Onlay

Tables

TWO POSITION ARMLESS

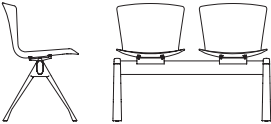

TWO POSITION, TWO ARM

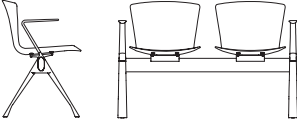

TWO POSITION, THREE ARM

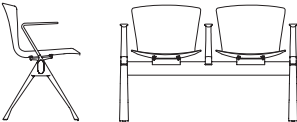

THREE POSITION ARMLESS

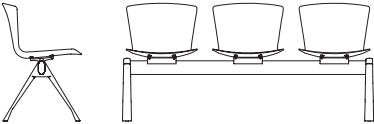

THREE POSITION, TWO ARM

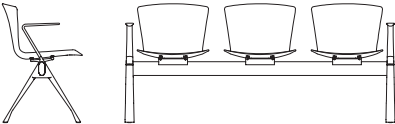

THREE POSITION, FOUR ARM

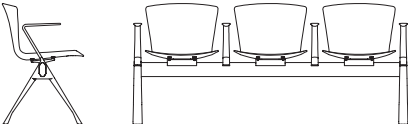

FOUR POSITION ARMLESS

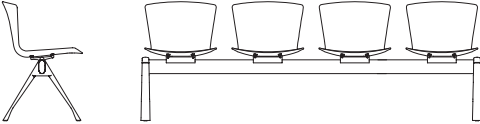

FOUR POSITION, TWO ARM

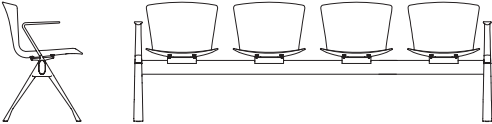

FOUR POSITION, FIVE ARM

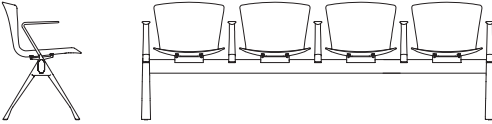

Beam Model

TWO POSITION	CODE
Armless	SB2NA
Two Arm	SB22A
Three Arm	SB23A

THREE POSITION	CODE
Armless	SB3NA
Two Arm	SB32A
Four Arm	SB34A

FOUR POSITION	CODE
Armless	SB4NA
Two Arm	SB42A
Five Arm	SB45A

Beam Finish

DESCRIPTION	CODE
White Textured Powder Coat	WT
Black Textured Powder Coat	BT
Grey Textured Powder Coat	GT
Sterling	ST

Glides

Slam Beam glides are nylon.

Auxiliary Options

DESCRIPTION	CODE
Floor Mount	FM

For a quote on Floor Mount options, please contact Customer Experience.

Freight Note

Due to the size and nature of Slam Beam, the Freight Program does not apply to this product. Please contact Customer Experience for a quote.

Specifications required to create the product code

- Model
- Beam Finish
- Floor Mount (when applicable)



MODEL

Three position,
Armless (SB3NA)

BEAM FINISH

White Textured Powder coat (WT)

FLOOR MOUNT

When applicable, enter Slam Beam
Floor Mount Code (FM)



SLAM BEAM BASE, TWO POSITION
 Design: Lievore Altherr Molina, licensed by Sellex

SB10

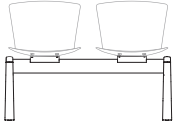

Two Position, Armless	MODEL	LIST PRICE
W 39.25 D 21 H 31	SB2NA Powdercoat	\$2140

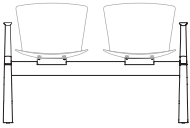

Two Position, Two Arm	MODEL	LIST PRICE
W 43.5 D 21 H 31	SB22A Powdercoat	\$2285

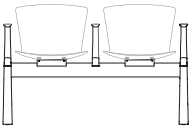

Two Position, Three Arm	MODEL	LIST PRICE
W 43.5 D 21 H 31	SB23A Powdercoat	\$2431

To specify:
 Refer to pages SB6-SB7

SLAM BEAM BASE, THREE POSITION
Design: Lievore Altherr Molina, licensed by Sellex

SB11

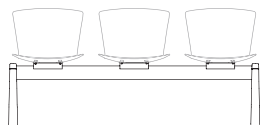

Three Position, Armless

MODEL

LIST PRICE

W 66 D 21 H 31

SB3NA

Powdercoat

\$2272

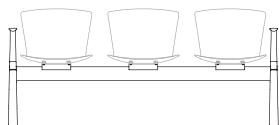

Three Position, Two Arm

MODEL

LIST PRICE

W 70.25 D 21 H 31

SB32A

Powdercoat

\$2418

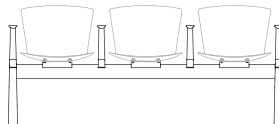

Three Position, Three Arm

MODEL

LIST PRICE

W 70.25 D 21 H 31

SB34A

Powdercoat

\$2563

To specify:
Refer to pages SB6-SB7

Pricing Effective: July 2021

SLAM BEAM BASE, FOUR POSITION
 Design: Lievore Altherr Molina, licensed by Sellex

SB12

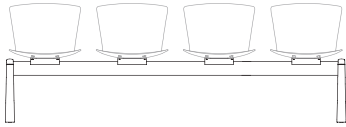

Four Position, Armless	MODEL	LIST PRICE
W 88.5 D 21 H 31	SB4NA Powdercoat	\$2612

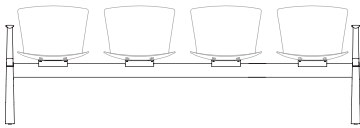

Four Position, Two Arm	MODEL	LIST PRICE
W 93 D 21 H 31	SB42A Powdercoat	\$2758

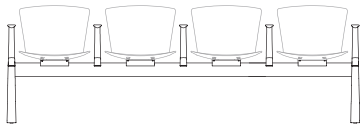

Four Position, Five Arm	MODEL	LIST PRICE
W 93 D 21 H 31	SB45A Powdercoat	\$2977

To specify:
 Refer to pages SB6-SB7

Shell Selection

DESCRIPTION	CODE
Polypropylene	PO
Polypropylene with Upholstered Seat Onlay	PU
Fully Upholstered	FU
Beech 3D Veneer	3DB
Beech 3D Veneer with Upholstered Seat Onlay	3BU
Oak 3D Veneer	3DO
Oak 3D Veneer with Upholstered Seat Onlay	3OU

Shell Finish**POLYPROPYLENE SHELL:**

DESCRIPTION	CODE	DESCRIPTION	CODE
White	W	Grey	G
Black	B		

CUSTOM POLYPROPYLENE COLORS

Custom color match is available upon request. Please contact hello@lelandinternational.com for further information

BEECH 3D VENEER SHELL:

DESCRIPTION	CODE
Natural Beech	09

STANDARD LELAND COLORS**OAK 3D VENEER SHELL:**

DESCRIPTION	CODE
Natural White Oak	12
Custom	CST

Shell Finish/Color**POLYPROPYLENE SHELL:**

DESCRIPTION	CODE	DESCRIPTION	CODE
White	WT	Arctic	AR
Black	BK	Caribbean	CB
Soda Red	SR	Ink	IN
Dolphin	DL	Limelight	LL
Oxford	OX	Tangerine	TN
Ice Blue	IB		

CUSTOM POLYPROPYLENE COLORS

Custom color match is available upon request.
Please contact hello@lelandfurniture.com for further information

BEECH 3D VENEER SHELL:

DESCRIPTION	CODE
Natural Beech	09

STANDARD LELAND COLORS**AMERICAN WALNUT 3D VENEER SHELL:**

DESCRIPTION	CODE
Natural Walnut Matte	08M

Shell Finish/Color (cont)**FULLY UPHOLSTERED SHELL**

Please refer to Leland Textile Program which features textiles and leathers from the following partners:

- Camira
- Carnegie
- CF Stinson
- Green Hides
- Maharam
- Unika Vaev

The complete grade list can be found at www.lelandfurniture.com/ecatalog or you can specify COM/COL. Due to the design of this product, it is recommended that all non pre-approved textile be tested for compatibility.

Upholstered Onlay selection

Please refer to Leland Textile Program which features textiles and leathers from the following partners:

- Camira
- Carnegie
- CF Stinson
- Green Hides
- Maharam
- Unika Vaev

The complete grade list can be found at lelandinternational.com/ecatalog or you can specify COM/COL. Due to the design of this product, it is recommended that all non pre-approved textile be tested for compatibility.

Specifications required to create the product code

- Shell Selection
- Shell Finish
- Upholstered Onlay Selection (When Applicable)

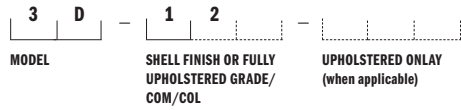

SHELL SELECTION

3D Veneer Shell (3D)

SHELL FINISH

Natural White Oak (12)

UPHOLSTERED ONLAY SELECTION

When applicable, enter upholstery grade, COM or COL

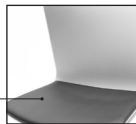

SLAM BEAM SHELL SELECTION
 Design: Lievore Altherr Molina, licensed by Sellex

SB15



Polypropylene

MODEL	LIST PRICE
PO	\$174



**Polypropylene W/
 Upholstered Seat Only**

MODEL	COM/COL	A	B	C	D	E	F	G	H	I	J	K	L
PU	\$288	350	381	413	444	475	507	538	569	601	632	663	695

COM Yardage: 1 or 2 seats: .75 yard
 Contact Leland Customer Experience for yardage requirements on textiles with repeats.
 For COL requirements please contact Leland Customer Experience.



Fully Upholstered

MODEL	COM/COL	A	B	C	D	E	F	G	H	I	J	K	L
FU	\$408	473	506	539	571	605	637	671	704	736	770	802	835

COM Yardage: 1 or 2 seats: .75 yard
 Contact Leland Customer Experience for yardage requirements on textiles with repeats.
 For COL requirements please contact Leland Customer Experience.

To specify:
 Refer to pages SB11-SB12

SLAM BEAM SHELL SELECTION
 Design: Lievore Altherr Molina, licensed by Sellex

SB16



3D Beech Veneer	MODEL	LIST PRICE
	3DB	\$583



3D Beech Veneer W/ Upholstered Seat Only	MODEL	COM/COL	A	B	C	D	E	F	G	H	I	J	K	L
	3BU	\$699	761	792	824	855	886	918	949	980	1012	1043	1074	1106

COM Yardage: 1 or 2 seats: .75 yard
 Contact Leland Customer Experience for yardage requirements on textiles with repeats.
 For COL requirements please contact Leland Customer Experience.



3D Oak Veneer	MODEL	LIST PRICE
	3DO	\$735



3D Oak Veneer W/ Upholstered Seat Only	MODEL	COM/COL	A	B	C	D	E	F	G	H	I	J	K	L
	3OU	\$851	912	944	975	1006	1038	1069	1100	1132	1163	1194	1226	1257

COM Yardage: 1 or 2 seats: .75 yard
 Contact Leland Customer Experience for yardage requirements on textiles with repeats.
 For COL requirements please contact Leland Customer Experience.

To specify:
 Refer to pages SB11-SB12

Table Model

DESCRIPTION	CODE
Slam table	SBT

Top Finish or Color

LAMINATE TOP:

DESCRIPTION	CODE
Black (Pionite® Suede Black)	LBK
White (WilsonArt® Designer White) LWH Custom	CST

Edge Finish

DESCRIPTION	CODE
Opaque Black	B
Opaque White	W
Natural	11

Specifications required to create the product code

- Table Model
- Top Finish
- Edge Finish



TABLE MODEL

Slam Beam Table (SBT)

TOP FINISH

White Laminate (W)

EDGE FINISH

Opaque White (W)



Slam Beam Table	MODEL	FRAME FINISH	LIST PRICE
one base position	SBT	Laminate	\$277

W 22 D 22
TH 17.75 (MOUNTED TO BASE)

Please note that Opaque White and Opaque Black Edge Finishes will have an additional \$20 NET charge.



To specify:
Refer to pages SB14-SB15

Slam Beam Floor Mount	MODEL	LIST PRICE
	SBFM	\$184

Floor mount must be specified at the time of order.
Due to the variety of floor surfaces on which Slam Beam may be installed, floor mount fasteners are not supplied by Leland.
Responsibility of fastener choice is the customers.

To specify:
Refer to pages SB14-SB15

**5695 Eagle Drive, SE
Grand Rapids,
Michigan 49512
616-975-9260
lelandfurniture.com**

Valeri Seating

July 2021 Price List



Valeri

Table of Contents	VS2
Specification Information	VS3
Specification Example	VS4
Guest Chair, Lounge Chair, Settee	VS5

Chair Model

DESCRIPTION	CODE
Valeri guest chair	VG
Valeri lounge chair	VL
Valeri settee	VS

Frame Finish

DESCRIPTION	CODE
Brushed stainless steel	SS

Upholstery Selection

Please refer to Leland Textile Program which features textiles and leathers from the following partners:

- Camira
- Carnegie
- CF Stinson
- Green Hides
- Maharam
- Unika Vaev

The complete grade list can be found at lelandinternational.com/ecatalog or you can specify COM/COL. Due to the design of this product, it is recommended that all non pre-approved textile be tested for compatibility.

Glides

Valeri glides are steel swivel with nylon bottom.

Freight Note

Due to the size and nature of Valeri Seating, the Freight Program does not apply to this product. Please contact Customer Experience for a quote.

Specifications required to create the product code

- Model
- Frame Finish
- Upholstery Selection



MODEL

Valeri Lounge Chair (VL)

FRAME FINISH

Brushed Stainless Steel (SS)

UPHOLSTERY SELECTION

Enter upholstery grade, COM or COL. Grade J (J)





Valeri Guest Chair

W 21.5 D 23 H 29
SH 18 AH 24.5

MODEL	LIST PRICE/ GRADE	COM/COL	A	B	C	D	E	F	G	H	I	J	K	L
VG		\$1440	1540	1592	1642	1694	1745	1796	1847	1898	1949	2000	2052	2102

COM Yardage: 1 or 2 chairs: 1.75 yards
Contact Leland Customer Experience for yardage requirements on textiles with repeats.
For COL requirements please contact Leland Customer Experience.

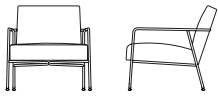

Valeri Lounge Chair

W 27.5 D 29.5 H 27
SH 15 AH 21

MODEL	LIST PRICE/ GRADE	COM/COL	A	B	C	D	E	F	G	H	I	J	K	L
VL		\$2043	2187	2261	2333	2406	2478	2552	2624	2696	2769	2841	2915	2987

COM Yardage: 1 chair: 2.5 yards; 2 chairs: 3 yards; 3 or 4 chairs: 6 yards; 5 chairs: 6.5 yards
Contact Leland Customer Experience for yardage requirements on textiles with repeats.
For COL requirements please contact Leland Customer Experience.

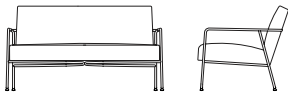

Valeri Settee

W 50 D 29.5 H 27
SH 15 AH 21

MODEL	LIST PRICE/ GRADE	COM/COL	A	B	C	D	E	F	G	H	I	J	K	L
VS		\$3195	3486	3631	3776	3922	4067	4213	4358	4503	4648	4794	4939	5084

COM Yardage: 1 settee: 3 yards
Due to upholstery requirements, Valeri Settee textile can only be upholstered railroaded.
Please consider when specifying upholstery with a pattern or repeat.
Contact Leland Customer Experience for yardage requirements on textiles with repeats.
For COL requirements please contact Leland Customer Experience.

To specify:
Please refer to pages 3-4 for complete specifying information.
Specify all products by their product code.

**5695 Eagle Drive, SE
Grand Rapids,
Michigan 49512
616-975-9260
lelandfurniture.com**

freshcoast collection
2021 PRICE LIST

Pricing Effective July 2021



TABLE OF CONTENTS

July 2021 Pricelist

BdVgUf E; @e

Chair & Table Size Recommendations

Shell Art Index

6UWGbVgZGB' ' +%&@G6

7frgUzGB' ' +%&

9YzGB' ' +127LFSB

<UxZGB' ' +%&

Little Marquette, SIN 33721T

Manitou, SIN 33721T

Quince, SIN 337127LFSB

Zoon, SIN 33712

recommended chair height and table combination

Size pairings are based on the seat height of the chair.
Table heights are paired with seating as ergonomically appropriate.
These suggestions are based on international averages for child size by age and are considered to be approximate only.

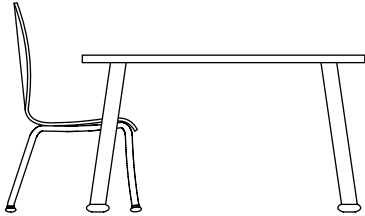

ages 4-9
12" seat height
20" table height

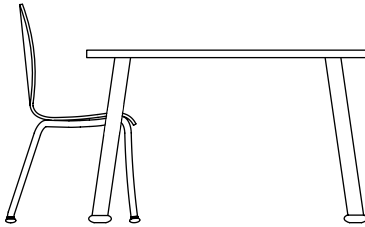

ages 7-12
14" seat height
22" table height

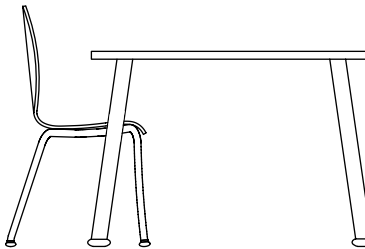

ages 10-15
16" seat height
25" table height

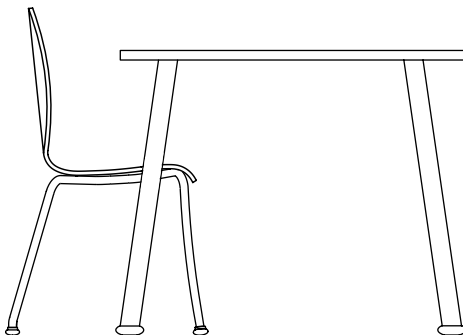

adult
18" seat height
29" table height

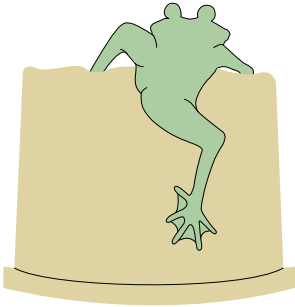

eve creatures

A CNC laser is used to cut a chair shell forming a three dimensional image on the chair back. Often, one side of the chair will show the creatures front side characteristics (such as eyes and nose) and the opposite side will show the creatures backside characteristics (such as a tail). Laser engraving and laser cutting is typically combined to create the different characteristics of the eve creature. See page EV3 for a complete list of eve creatures.

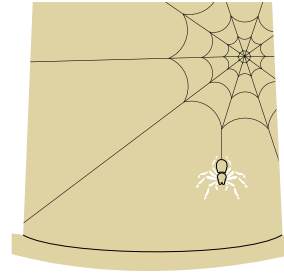

laser engraving

A CNC laser is used to make an engraving that penetrates the surface of the chair shell. The shell may be engraved on either or both sides.

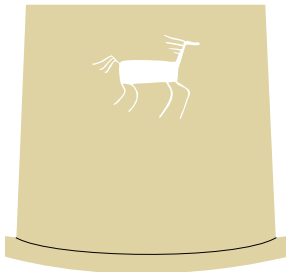

laser cutout

A CNC laser is used to cut through the back of the shell, forming an opening. This space creates an image that is visible from both sides of the chair shell.



custom

You dream it, we can do it.

freshcoast shell art collections

Please refer to the freshcoast children’s brochure for details on scale and placement of shell art. If no shell art is desired, use code F999.

swamp things
grade 1

description
code



snake
(F001)



lizard
(F002)



tree frog
(F003)



turtle
(F004)

safari
grade 1

description
code



rhinoceros
(F005)



elephant
(F006)



lioness
(F007)



ostrich
(F008)



giraffe
(F009)

petroglyphs
grade 1

description
code



ram
(F010)



antelope
(F011)



deer
(F012)



caribou
(F013)



horse
(F014)

birds
grade 2

description
code



hummingbird
(F015)



owl
(F016)



woodpecker
(F017)



dove
(F018)

celestial
grade 1&2

description
code



moon
(F019)



sun
(F020)
grade 1



star
(F021)



saturn
(F022)



shooting star
(F023)
grade 2



moon among stars
(F024)

freshcoast shell art collections, continued

Please refer to the freshcoast children's brochure for details on scale and placement of shell art. If no shell art is desired, use code F999.

sea life
grade 1&2

description
code

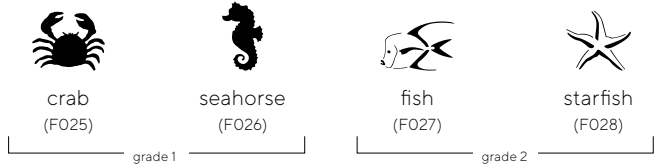

animal tracks
grade 2

description
code



shapes
grade 1

description
code

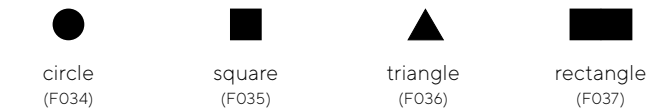

dinosaurs
grade 1

description
code



insects
grade 1&2

description
code

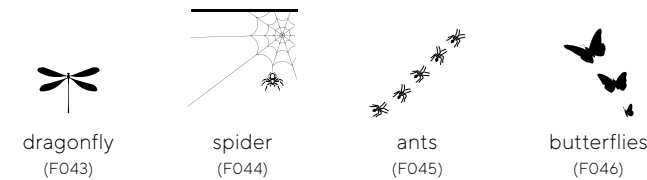

freshcoast collection
**CHILDREN'S
BEACH STONES**

2021 Price List

Pricing Effective July 2021



children's beach stones price list

+ beach stones: table of contents..... BSC2

+ beach stones specification information BSC3

+ beach stones specification example..... BSC4

+ beach stones BSC5-BSC6

model

DESCRIPTION	CODE
Beach Stone A	BSA
Beach Stone B	BSB
Beach Stone B with wood back	BSBW
Beach Stone C	BSC
Beach Stone C with wood back	BSCW
Beach Stone D	BSD

Wood back is only offered on B and C benches.

back finish (wood back only)

TRANSPARENT FINISHES (SEMI-GLOSS SHEEN)		SEMI-TRANSPARENT FINISHES (MATTE-SHEEN)	
DESCRIPTION	CODE	DESCRIPTION	CODE
natural	11	arctic II	16M
medium	13	ink II	18M
neutral	15	limelight	33M
classic mahogany	21	caribbean II	48M
white wash II	30	soda red	46M
espresso	23	tangerine	40M
transparent black	29	ice blue	47M
graphite	25	oxford II	49M
		dolphin II	50M

shell art (wood back only)

Due to thickness of the wood back, only shell art listed below is available. When viewed from the front, all shell art will be placed on the upper left area of back.

DESCRIPTION	CODE	DESCRIPTION	CODE
moon	F019	circle	F034
sun	F020	square	F035
star	F021	triangle	F036

upholstery selection

Please refer to freshcoast Textile Program which features textiles and leathers from the following partners:

- Camira
- Carnegie
- CF Stinson
- Green Hides
- Maharam
- Unika Vaev

The complete grade list can be found at www.fc.studio/textile-partners or you can specify COM/COL. Due to the design of this product, it is recommended that all non pre-approved textile be tested for compatibility. Contact freshcoast for yardage requirements on textiles with repeats.

base finish

Black textured powder coat

SPECIFICATIONS REQUIRED TO CREATE THE PRODUCT CODE

- + **Model**
- + **Wood Back Finish (when applicable)**
- + **Wood Back Shell Art (when applicable)**
- + **Upholstery Selection**

B | **S** | **B** | **W** | - | **1** | **1** | - | **F** | **0** | **3** | **4** | - | **C** | **O** | **M** |

MODEL BACK FINISH SHELL ART UPHOLSTERY SELECTION
(WHEN APPLICABLE) (WHEN APPLICABLE)

model

Beach Stone B with wood back (BSBW)

back finish

Natural (11)

shell art

Shapes, Circle (F034)

upholstery selection

Upholstered (COM)



children's seating

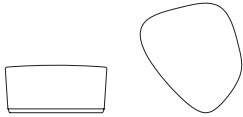

beach stone A

model

com/col a b c d e f g h i j k l

fully upholstered

BSA

\$823 914 959 1005 1050 1096 1141 1186 1232 1277 1323 1368 1414

W26.75 D28.75 H12.5

COM yardage: 2 yds.

Contact freshcoast customer care for COL requirements, textile testing requirements and yardage requirements for textiles with repeats.

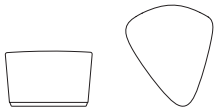

beach stone B

model

com/col a b c d e f g h i j k l

fully upholstered

BSB

\$863 941 980 1019 1058 1097 1136 1175 1213 1252 1291 1330 1369

W23 D26.5 H14.5

COM yardage: 1.25 yds.

Contact freshcoast customer care for COL requirements, textile testing requirements and yardage requirements for textiles with repeats.

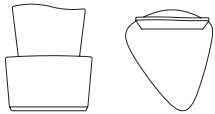

beach stone B

model

list price/grade

com/col a b c d e f g h i j k l

fully upholstered, wood back

BSBW

plain back

\$1080 1158 1197 1236 1275 1314 1353 1392 1431 1470 1509 1548 1587

W23 D26.5 H28.25 SH14.5

shell art

\$1125 1203 1242 1280 1319 1358 1397 1436 1475 1514 1553 1592 1631

COM yardage: 1.25 yds.

Contact freshcoast customer car for COL requirements, textile testing requirements and yardage requirements for textiles with repeats.

to specify: please refer to pages 3-4 for complete specifying information. Specify all products by their product code.

pricing effective: July 2021

children's seating



beach stone C	model	com/col	a	b	c	d	e	f	g	h	i	j	k	l
fully upholstered	BSC	\$884	961	1000	1039	1078	1117	1156	1195	1234	1273	1312	1351	1390
W25.5 D22.25 H16.5		COM yardage: 2 yds. Contact freshcoast customer care for COL requirements, textile testing requirements and yardage requirements for textiles with repeats.												

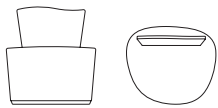

beach stone C	model		com/col	a	b	c	d	e	f	g	h	i	j	k	l
fully upholstered, wood back	BSCW	plain back	\$1102	1180	1219	1258	1297	1336	1375	1414	1452	1491	1530	1569	1608
W25.5 D22.25 H27.75 SH16.5		shell art	\$1144	1222	1261	1300	1339	1378	1417	1456	1495	1534	1573	1611	1650
			COM yardage: 2 yds. Contact freshcoast customer care for COL requirements, textile testing requirements and yardage requirements for textiles with repeats.												

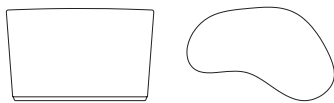

beach stone D	model	list price/grade	com/col	a	b	c	d	e	f	g	h	i	j	k	l
fully upholstered	BSD		\$913	1069	1146	1224	1302	1380	1458	1536	1614	1691	1769	1847	1925
W39 D24.75 H24.5			COM yardage: 3 yds. Contact freshcoast customer care for COL requirements, textile testing requirements and yardage requirements for textiles with repeats.												

to specify: please refer to pages 3-4 for complete specifying information. Specify all products by their product code.

pricing effective: July 2021

freshcoast collection
BEACH STONES

2021 Price List

Pricing Effective July 2021



fc freshcoast
by LELAND

beach stones price list

- + beach stones: table of contentsBSC2
- + beach stones specification information.....BSC3
- + beach stones specification example.....BSC4
- + beach stones seatingBSC5
- + beach stone table.....BSC6

model

DESCRIPTION	CODE
Beach Stone E	BSE
Beach Stone F	BSF
Beach Stone G	BSG
Beach Stone H	BSH
Beach Stone I	BSI
Beach Stone J	BSJ
Beach Stone K	BSK
Beach Stone L	BSL

upholstery selection

Please refer to freshcoast Textile Program which features textiles and leathers from the following partners:

- Camira
- Carnegie
- CF Stinson
- Green Hides
- Maharam
- Unika Vaev

The complete grade list can be found at www.fc.studio/textile-partners or you can specify COM/COL. Due to the design of this product, it is recommended that all non pre-approved textile be tested for compatibility. Contact freshcoast for yardage requirements on textiles with repeats.

base finish

Black textured powder coat

table top finish

SOLID SURFACE

DESCRIPTION	CODE
Black Corian®	CB
White Corian®	CW
Grey Corian®	CG

GLASS

DESCRIPTION	CODE
Black Back painted Glass	BG
Grey Back painted Glass	GG
White Back painted Glass	WG

SPECIFICATIONS REQUIRED TO CREATE THE PRODUCT CODE

- + Model
- + Upholstery Selection
- + Table Top Finish (when applicable)

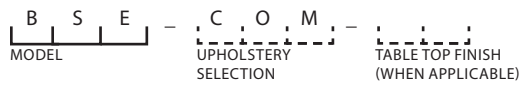

model

Beach Stone E (BSE)

upholstery selection

Upholstered (COM)



TABLE TOP FINISH

When applicable

seating



beach stone e	model	com/col	a	b	c	d	e	f	g	h	i	j	k	l
fully upholstered	BSE	\$ 1310	1465	1543	1621	1699	1777	1855	1933	2011	2088	2166	2244	2322
W 32 D 24 H 25 SH 18		COM yardage: 2.5 yds. Contact freshcoast customer care for COL requirements, textile testing requirements and yardage requirements for textiles with repeats.												



beach stone F	model	com/col	a	b	c	d	e	f	g	h	i	j	k	l
fully upholstered	BSF	\$ 1288	1444	1522	1600	1677	1755	1833	1911	1989	2067	2145	2222	2300
W 32 D 24 H 26 SH 18		COM yardage: 2.5 yds. Contact freshcoast customer care for COL requirements, textile testing requirements and yardage requirements for textiles with repeats.												



beach stone G	model	com/col	a	b	c	d	e	f	g	h	i	j	k	l
fully upholstered	BSG	\$ 1304	1460	1538	1616	1694	1771	1849	1927	2005	2083	2161	2239	2317
W 32 D 24 H 31 SH 18		COM yardage: 2.5 yds. Contact freshcoast customer care for COL requirements, textile testing requirements and yardage requirements for textiles with repeats.												



beach stone H	model	com/col	a	b	c	d	e	f	g	h	i	j	k	l
fully upholstered	BSH	\$ 868	1024	1102	1180	1258	1336	1414	1491	1569	1647	1725	1803	1881
W 48 D 18 H 18		COM yardage: 2.5 yds. Contact freshcoast customer care for COL requirements, textile testing requirements and yardage requirements for textiles with repeats.												



beach stone I	model	com/col	a	b	c	d	e	f	g	h	i	j	k	l
fully upholstered	BSI	\$ 782	886	938	990	1041	1093	1145	1197	1249	1301	1353	1405	1457
W 33 D 22 H 18		COM yardage: 1.75 yds. Contact freshcoast customer care for COL requirements, textile testing requirements and yardage requirements for textiles with repeats.												

to specify; please refer to pages 3–4 for complete specifying information. Specify all products by their product code.

tables

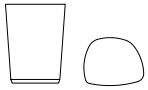

beach stone J	model	com/col	a	b	c	d	e	f	g	h	i	j	k	l
upholstered w/ Corian*	BSJ	\$ 914	966	992	1018	1044	1070	1096	1122	1147	1173	1199	1225	1251

W 17 D 13 H 22

COM yardage: 1 yd.

Contact freshcoast customer care for COL requirements, textile testing requirements and yardage requirements for textiles with repeats.

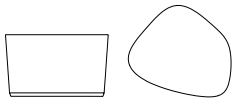

beach stone K	model	com/col	a	b	c	d	e	f	g	h	i	j	k	l
upholstered w/ Corian*	BSK	\$ 914	1018	1070	1122	1173	1225	1277	1329	1381	1433	1485	1537	1589

W 30 D 27 H 18

COM yardage: 2 yds.

Contact freshcoast customer care for COL requirements, textile testing requirements and yardage requirements for textiles with repeats.

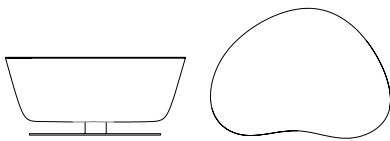

beach stone L	model	com/col	a	b	c	d	e	f	g	h	i	j	k	l
upholstered w/ Corian*	BSL	\$ 2859	3015	3093	3171	3249	3327	3405	3482	3560	3638	3716	3794	3872

W 47 D 34 H 20

COM yardage: 3 yds.

Contact freshcoast customer care for COL requirements, textile testing requirements and yardage requirements for textiles with repeats.

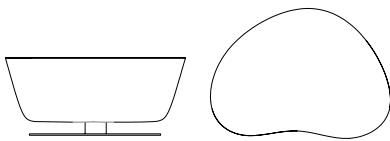

beach stone L	model	com/col	a	b	c	d	e	f	g	h	i	j	k	l
upholstered w/ backpainted glass	BSL	\$ 3120	3276	3354	3432	3509	3587	3665	3743	3821	3899	3977	4055	4132

W 47 D 34 H 20

COM yardage: 3 yds.

Contact freshcoast customer care for COL requirements, textile testing requirements and yardage requirements for textiles with repeats.

to specify; please refer to pages 3–4 for complete specifying information. Specify all products by their product code.



freshcoast collection

**CRYSTAL
CHILDREN'S TABLE**

2021 Price List

Pricing Effective July 2021



freshcoast
by LELAND

crystal children's table price list

- + crystal table: table of contents CYT2
- + crystal table specification information CYT3
- + crystal table specification example CYT4
- + crystal 20 inch height table CYT5
- + crystal 22 inch height table CYT6
- + crystal 25 inch height table CYT7

model

DESCRIPTION	CODE
Crystal children's table	CYT

table height

DESCRIPTION	CODE
20 inch table height	20H
22 inch table height	22H
25 inch table height	25H

base finish

Select from freshcoast Colors I & II.

top size

ROUND CODE	CODE	SQUARE	CODE	RECTANGLE	CODE
36 dia	36D	36x36	3636	30x60	3060
42 dia	42D	42x42	4242		
48 dia	48D	48x48	4848		

top surface finish or color

WOOD TOP:

TRANSPARENT FINISHES (SEMI-GLOSS SHEEN)

DESCRIPTION	CODE
natural	11
medium	13
neutral	15
classic mahogany	21
espresso	23
white wash II	30
transparent black	29
graphite	25

SEMI-TRANSPARENT FINISHES (MATTE-SHEEN)

DESCRIPTION	CODE
arctic ii	16M
ink ii	18M
limelight	33M
caribbean II	48M
soda red	46M
tangerine	40M
ice blue	47M
oxford II	49M
dolphin II	50M

top surface finish or color, cont.

LAMINATE TOP:

DESCRIPTION	CODE
Identify manufacturer, laminate code, & color	L

Please refer to the freshcoast Terms and Conditions for a listing of standard laminates. For table pricing in laminates not listed, please contact freshcoast for a quotation.

edge type

SOFT VINYL EDGE:

DESCRIPTION	CODE
13/16" flat PVC	V2



WOOD EDGE:

DESCRIPTION	CODE
1" flat plywood	W2



edge finish or color

SOFT VINYL EDGE:

DESCRIPTION	CODE
black	B
white	W
grey	G

WOOD EDGE:

Select from freshcoast Colors I & II.

Wood top with wood edge must be specified in the same finish. Laminate top with wood edge may be specified in any freshcoast finish.

SPECIFICATIONS REQUIRED TO CREATE THE PRODUCT CODE

- + Model
- + Table Height
- + Base Finish
- + Top Size
- + Top Surface Finish or Color
- + Edge Type
- + Edge Finish or Color

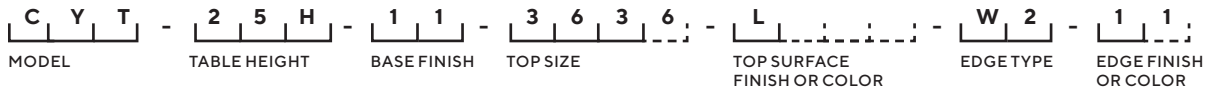

MODEL

Crystal children's table (CYT)

TABLE HEIGHT

25 inch table height (25H)

BASE FINISH

Natural (11)

TOP SIZE

36 X 36 (3636)

TOP SURFACE FINISH OR COLOR

Laminate (L)

EDGE TYPE

1 inch flat plywood (W2)



EDGE FINISH OR COLOR

Natural (11)

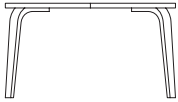

20 inch height



crystal table	model	top size/code	list price/edge codes	V2	W2
curved plywood base	CYT-20H	wood top			
H20		36 dia – 36D		\$1144	1430
 round	 square	42 dia – 42D		\$1175	1469
	 rectangle	48 dia – 48D		\$1207	1508
36 DIA	36 x 36	36 x 36 – 3636		\$1152	1440
42 DIA	42 x 42	42 x 42 – 4242		\$1180	1478
48 DIA	48 x 48	48 x 48 – 4848		\$1212	1516
		30 x 60 – 3060		\$1178	1474
		laminatE top			
		36 dia – 36D		\$1117	1394
		42 dia – 42D		\$1145	1433
		48 dia – 48D		\$1176	1470
		36 x 36 – 3636		\$1122	1402
		42 x 42 – 4242		\$1153	1441
		48 x 48 – 4848		\$1180	1479
		30 x 60 – 3060		\$1152	1438

to specify: please refer to pages 3–4 for complete specifying information. Specify all products by their product code.

pricing effective: July 19, 2021 1:08 PM

22 inch height



crystal table

model

top size/code

list price/edge codes

V2

W2

curved plywood base

CYT-22H

wood top

H22



round



square



rectangle

36 DIA

36 x 36

30 x 60

42 DIA

42 x 42

48 DIA

48 x 48

36 dia – 36D

\$1173

1467

42 dia – 42D

\$1205

1506

48 dia – 48D

\$1236

1546

36 x 36 – 3636

\$1178

1478

42 x 42 – 4242

\$1210

1516

48 x 48 – 4848

\$1241

1554

30 x 60 – 3060

\$1208

1514

laminated top

36 dia – 36D

\$1145

1433

42 dia – 42D

\$1176

1470

48 dia – 48D

\$1207

1507

36 x 36 – 3636

\$1153

1441

42 x 42 – 4242

\$1180

1479

48 x 48 – 4848

\$1212

1516

30 x 60 – 3060

\$1179

1476

to specify: please refer to pages 3–4 for complete specifying information. Specify all products by their product code.

pricing effective: July 19, 2021 1:08 PM

CYT6

25 inch height

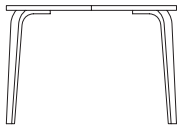

crystal table

model

top size/code

list price/edge codes

V2

W2

curved plywood base

CYT-25H

H25



round



square



rectangle

36 DIA

36 x 36

30 x 60

42 DIA

42 x 42

48 DIA

48 x 48

wood top

36 dia – 36D

\$1207

1508

42 dia – 42D

\$1237

1546

48 dia – 48D

\$1269

1585

36 x 36 – 3636

\$1212

1516

42 x 42 – 4242

\$1242

1554

48 x 48 – 4848

\$1274

1593

30 x 60 – 3060

\$1240

1552

laminated top

36 dia – 36D

\$1176

1470

42 dia – 42D

\$1207

1507

48 dia – 48D

\$1236

1545

36 x 36 – 3636

\$1180

1479

42 x 42 – 4242

\$1212

1516

48 x 48 – 4848

\$1241

1553

30 x 60 – 3060

\$1210

1514

to specify: please refer to pages 3–4 for complete specifying information. Specify all products by their product code.

pricing effective: July 19, 2021 1:08 PM

freshcoast collection

**CRYSTAL
CHILDREN'S STOOL**

2021 Price List

Pricing Effective July 2021



freshcoast
by LELAND

crystal children's stool price list

- + crystal stool: table of contents CYS2
- + crystal stool specification information..... CYS3
- + crystal stool specification example CYS4
- + crystal 12 inch stool CYS5
- + crystal 14 inch stool CYS6
- + crystal 16 inch stool CYS7
- + crystal 18 inch stool CYS8

model

DESCRIPTION	CODE
Crystal stool	CYS

seat height

DESCRIPTION	CODE
12 inch seat height	SH12
14 inch seat height	SH14
16 inch seat height	SH16
18 inch seat height	SH18

base finish

Select from freshcoast Colors I & II.

seat size

ROUND	CODE
18 dia	18D
26 dia	26D
36 dia	36D

seat surface finish or color

WOOD SEAT:

TRANSPARENT FINISHES (SEMI-GLOSS SHEEN)

DESCRIPTION	CODE
natural	11
medium	13
neutral	15
classic mahogany	21
espresso	23
white wash II	30
transparent black	29
graphite	25

SEMI-TRANSPARENT FINISHES (MATTE-SHEEN)

DESCRIPTION	CODE
arctic ii	16M
ink ii	18M
limelight	33M
caribbean II	48M
soda red	46M
tangerine	40M
ice blue	47M
oxford II	49M
dolphin II	50M

top surface finish or color, cont.

UPHOLSTERED SEAT:

DESCRIPTION	CODE
Customer's Own Material	COM

Upholstery is Customer's Own Material (COM). Due to the design of this product, it is required that all non pre-approved textiles be tested for compatibility. Untested textiles will not be accepted. Contact freshcoast for yardage requirements on textiles with repeats.

Please refer to freshcoast Textile Program which features textiles and leathers from the following partners:

- Camira
- Carnegie
- CF Stinson
- Green Hides
- Maharam
- Unika Vaev

The complete grade list can be found at www.fc.studio/textile-partners or you can specify COM/COL. Due to the design of this product, it is recommended that all non pre-approved textile be tested for compatibility.

edge type

SOFT VINYL EDGE:

DESCRIPTION	CODE
13/16" flat PVC	V2



WOOD EDGE:

DESCRIPTION	CODE
1" flat plywood	W2



*upholstered seat does not require an edge selection

edge finish or color

SOFT VINYL EDGE:

DESCRIPTION	CODE
black	B
white	W
grey	G

WOOD EDGE:

Select from freshcoast Colors I & II.

Wood top with wood edge must be specified in the same finish.

SPECIFICATIONS REQUIRED TO CREATE THE PRODUCT CODE

- + **Model**
- + **Seat Height**
- + **Base Finish**
- + **Seat Size**
- + **Top Surface Finish / Color / Upholstery**
- + **Edge Type (when applicable)**
- + **Edge Finish or Color (when applicable)**

C Y S - **S H 1 6** - **1 1** - **3 6 D** - **6 5** - **W 2** - **6 5**
MODEL SEAT HEIGHT BASE FINISH SEAT SIZE TOP SURFACE FINISH COLOR/UPHOLSTERY EDGE TYPE (WHEN APPLICABLE) EDGE FINISH OR COLOR (WHEN APPLICABLE)

MODEL

Crystal stool (CYS)

SEAT HEIGHT

16 inch seat height (SH16)

BASE FINISH

Natural (11)

SEAT SIZE

36 dia (36D)

TOP SURFACE FINISH / COLOR / UPHOLSTERY

Lime (65)

EDGE TYPE

1 inch flat plywood (W2)

EDGE FINISH OR COLOR

Lime (65)



12 inch seat height

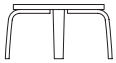

crystal stool	model	list price/grade	list price/edge codes	V2	W2
12" stool, curved plywood base, wood seat	CYS-SH12	18 dia – 18D		\$572	716
		26 dia – 26D		\$649	812
		36 dia – 36D		\$744	932

H12



round

18 DIA

26 DIA

36 DIA

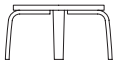

crystal stool	model	list price/grade	com/col	a	b	c	d	e	f	g	h	i	j	k	l
12" stool, curved plywood base, upholstered seat	CYS-SH12	18 dia – 18D	\$757	794	813	831	850	868	887	905	924	942	961	980	998
		26 dia – 26D	\$852	901	926	951	975	1000	1025	1050	1074	1099	1124	1148	1173
		36 dia – 36D	\$973	1048	1085	1122	1159	1196	1233	1270	1307	1344	1381	1418	1455

H12



round

18 DIA

26 DIA

36 DIA

COM yardage: 18 dia: ¾ yd, 26 dia: 1 yd, 36 dia 1½ yds

Contact freshcoast customer care for COL requirements, textile testing requirements and yardage requirements for textiles with repeats.

to specify: please refer to pages 3-4 for complete specifying information. Specify all products by their product code.

pricing effective: September 15, 2021 3:56 PM

14 inch seat height

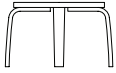

crystal stool	model	list price/grade	list price/edge codes	V2	W2
14" stool, curved plywood base, wood seat	CYS-SH14	18 dia – 18D		\$633	792
		26 dia – 26D		\$712	888
		36 dia – 36D		\$806	1009

H14



round

18 DIA

26 DIA

36 DIA

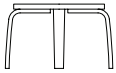

crystal stool	model	list price/grade	com/col	a	b	c	d	e	f	g	h	i	j	k	l
14" stool, curved plywood base, upholstered seat	CYS-SH14	18 dia – 18D	\$835	872	891	909	928	947	965	984	1002	1021	1039	1058	1076
		26 dia – 26D	\$931	981	1005	1030	1055	1079	1104	1129	1154	1178	1203	1228	1252
		36 dia – 36D	\$1052	1126	1163	1200	1237	1274	1311	1348	1385	1422	1460	1497	1534

H14



round

18 DIA

26 DIA

36 DIA

COM yardage: 18 dia: ¾ yd, 26 dia: 1 yd, 36 dia 1½ yds

Contact freshcoast customer care for COL requirements, textile testing requirements and yardage requirements for textiles with repeats.

to specify: please refer to pages 3–4 for complete specifying information. Specify all products by their product code.

pricing effective: September 15, 2021 3:56 PM

16 inch seat height

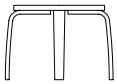

crystal stool	model	list price/grade	list price/edge codes	V2	W2
16" stool, curved plywood base, wood seat	CYS-SH16	18 dia – 18D		\$680	849
		26 dia – 26D		\$757	947
		36 dia – 36D		\$852	1066

H16



round

18 DIA

26 DIA

36 DIA

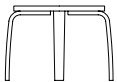

crystal stool	model	list price/grade	com/col	a	b	c	d	e	f	g	h	i	j	k	l
16" stool, curved plywood base, upholstered seat	CYS-SH16	18 dia – 18D	\$891	928	947	965	984	1002	1021	1039	1058	1076	1095	1113	1132
		26 dia – 26D	\$989	1038	1063	1088	1112	1137	1162	1187	1211	1236	1261	1285	1310
		36 dia – 36D	\$1108	1182	1220	1257	1294	1331	1368	1405	1442	1479	1516	1553	1590

H16



round

18 DIA

26 DIA

36 DIA

COM yardage: 18 dia: ¾ yd, 26 dia: 1 yd, 36 dia 1½ yds

Contact freshcoast customer care for COL requirements, textile testing requirements and yardage requirements for textiles with repeats.

to specify: please refer to pages 3–4 for complete specifying information. Specify all products by their product code.

pricing effective: September 15, 2021 3:56 PM

18 inch seat height

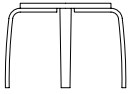

crystal stool	model	list price/grade	list price/edge codes	V2	W2
18" stool, curved plywood base, wood seat	CYS-SH18	18 dia – 18D		\$702	879
		26 dia – 26D		\$780	974
		36 dia – 36D		\$878	1096

H18



round

18 DIA

26 DIA

36 DIA

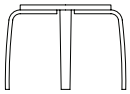

crystal stool	model	list price/grade	com/col	a	b	c	d	e	f	g	h	i	j	k	l
18" stool, curved plywood base, upholstered seat	CYS-SH18	18 dia – 18D	\$921	958	976	995	1014	1032	1051	1069	1088	1106	1125	1143	1162
		26 dia – 26D	\$1018	1067	1092	1117	1141	1166	1191	1215	1240	1265	1290	1314	1339
		36 dia – 36D	\$1137	1211	1248	1285	1323	1360	1397	1434	1471	1508	1545	1582	1619

H18



round

18 DIA

26 DIA

36 DIA

COM yardage: 18 dia: ¾ yd, 26 dia: 1 yd, 36 dia 1½ yds

Contact freshcoast customer care for COL requirements, textile testing requirements and yardage requirements for textiles with repeats.

to specify: please refer to pages 3–4 for complete specifying information. Specify all products by their product code.

pricing effective: September 15, 2021 3:56 PM

freshcoast collection

**CRYSTAL
CHILDREN'S LOW TABLE**

2021 Price List

Pricing Effective July 2021



freshcoast
by LELAND

crystal children's low table price list

- + crystal low table: table of contents..... CYLT2
- + crystal low table specification information..... CYLT3
- + crystal low table specification example CYLT4
- + crystal 12 inch height low table..... CYLT5
- + crystal 14 inch height low table..... CYLT6
- + crystal 16 inch height low table..... CYLT7
- + crystal 18 inch height low table..... CYLT8

model

DESCRIPTION	CODE
Crystal low table	CYLT

low table height

DESCRIPTION	CODE
12 inch low table height	12H
14 inch low table height	14H
16 inch low table height	16H
18 inch low table height	18H

base finish

Select from freshcoast Colors I & II.

top size

ROUND	CODE
26 dia	26D
36 dia	36D
42 dia	42D

top surface finish or color

WOOD TOP:

**TRANSPARENT FINISHES
(SEMI-GLOSS SHEEN)**

DESCRIPTION	CODE
natural	11
medium	13
neutral	15
classic mahogany	21
espresso	23
white wash II	30
transparent black	29
graphite	25

**SEMI-TRANSPARENT FINISHES
(MATTE-SHEEN)**

DESCRIPTION	CODE
arctic ii	16M
ink ii	18M
limelight	33M
caribbean II	48M
soda red	46M
tangerine	40M
ice blue	47M
oxford II	49M
dolphin II	50M

top surface finish or color, cont.

LAMINATE TOP:

DESCRIPTION	CODE
Identify manufacturer, laminate code, & color	L

Please refer to the freshcoast Terms and Conditions for a listing of standard laminates. For low table pricing in laminates not listed, please contact freshcoast for a quotation.

MARKER BOARD TOP:

DESCRIPTION	CODE
White surface for non-permanent dry erase markers.	M

Marker board top with W2 edge has Natural 11 edge finish.

edge type

SOFT VINYL EDGE:

DESCRIPTION	CODE
13/16" flat PVC	V2

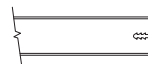

WOOD EDGE:

DESCRIPTION	CODE
1" flat plywood	W2



edge finish or color

SOFT VINYL EDGE:

DESCRIPTION	CODE
black	B
white	W
grey	G

WOOD EDGE:

Select from freshcoast Colors

Wood top with wood edge must be specified in the same finish. Laminate top with wood edge may be specified in any freshcoast finish. Markerboard tops with wood edge have Natural 11 edge finish.

SPECIFICATIONS REQUIRED TO CREATE THE PRODUCT CODE

- + Model
- + Low Table Height
- + Base Finish
- + Top Size
- + Top Surface Finish or Color
- + Edge Type
- + Edge Finish or Color



MODEL

Crystal low table (CYLT)

LOW TABLE HEIGHT

16 inch low table height (16H)

BASE FINISH

Natural (11)

TOP SIZE

36 dia (36D)

TOP SURFACE FINISH OR COLOR

Markerboard (M)

EDGE TYPE

1 inch flat plywood (W2)

EDGE FINISH OR COLOR

Natural (11)



12 inch height

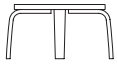

crystal low table

model

top size/code

list price/edge codes

V2

W2

curved plywood base

CYLT-12H

wood top

H 12

26 dia – 26D

\$572

716



round

36 dia – 36D

\$649

812

26 DIA

42 dia – 42D

\$707

884

36 DIA

lamine top

42 DIA

26 dia – 26D

\$552

691

36 dia – 36D

\$629

788

42 dia – 42D

\$687

859

marker board top

26 dia – 26D

\$839

1050

36 dia – 36D

\$1108

1386

42 dia – 42D

\$1379

1724

to specify: please refer to pages 3–4 for complete specifying information. Specify all products by their product code.

pricing effective: September 15, 2021 3:55 PM

CYLT5

14 inch height

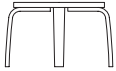

crystal low table

curved plywood base

H14



round

26 DIA

36 DIA

42 DIA

model

CYLT-14H

top size/code

wood top

26 dia – 26D

36 dia – 36D

42 dia – 42D

list price/edge codes

V2

W2

\$633

792

\$712

888

\$768

960

laminate top

26 dia – 26D

36 dia – 36D

42 dia – 42D

\$614

768

\$691

865

\$750

936

marker board top

26 dia – 26D

36 dia – 36D

42 dia – 42D

\$902

1126

\$1171

1463

\$1442

1800

to specify: please refer to pages 3–4 for complete specifying information. Specify all products by their product code.

pricing effective: September 15, 2021 3:55 PM

CYLT6

16 inch seat height

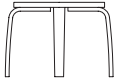

crystal low table	model	top size/code	list price/edge codes	V2	W2
curved plywood base H16  round 26 DIA 36 DIA 42 DIA	CYLT-16H	wood top			
		26 dia – 26D	\$680	849	
		36 dia – 36D	\$757	947	
		42 dia – 42D	\$815	1019	
		lamine top			
		26 dia – 26D	\$660	826	
		36 dia – 36D	\$737	922	
		42 dia – 42D	\$796	994	
		marker board top			
		26 dia – 26D	\$948	1182	
		36 dia – 36D	\$1216	1521	
		42 dia – 42D	\$1487	1859	

to specify: please refer to pages 3–4 for complete specifying information. Specify all products by their product code.

pricing effective: September 15, 2021 3:55 PM

18 inch seat height

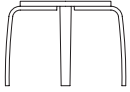

crystal low table

model

top size/code

list price/edge codes

V2

W2

curved plywood base

CYLT-18H

wood top

H18

26 dia – 26D

\$680

888



round

36 dia – 36D

\$757

986

26 DIA

42 dia – 42D

\$846

1058

36 DIA

lamine top

42 DIA

26 dia – 26D

\$691

865

36 dia – 36D

\$768

960

42 dia – 42D

\$827

1033

marker board top

26 dia – 26D

\$980

1224

36 dia – 36D

\$1247

1560

42 dia – 42D

\$1518

1898

to specify: please refer to pages 3–4 for complete specifying information. Specify all products by their product code.

pricing effective: September 15, 2021 3:55 PM

CYLT8

freshcoast collection

**EVE
CHILDREN'S CHAIR**

2021 Price List

Pricing Effective July 2021



eve children's chair price list

- + eve chair: table of contentsEV2
- + eve chair specification informationEV3
- + eve chair specification example EV5
- + eve 12 inch seat height chair EV6
- + eve 14 inch seat height chairEV7
- + eve 16 inch seat height chair EV8
- + eve 15 inch seat height sled base chair EV9
- + eve task base chair EV10

model

DESCRIPTION	CODE
Eve children's chair	EV
Eve children's chair, upholstered seat pad	EVU

shell style - wetland creatures

DESCRIPTION	CODE	DESCRIPTION	CODE
-------------	------	-------------	------



beaver
medium (13) P001



heron
aegean (78) P002

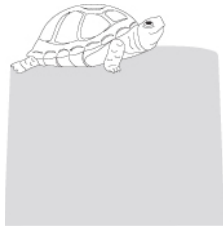

turtle
lime (65) P003

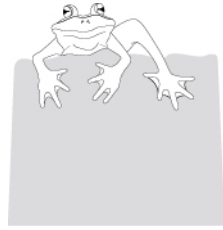

frog
sea grass (79) P004



duck
citrus (73) P005



trout
cactus (82) P006

shell style - woodland creatures

DESCRIPTION	CODE	DESCRIPTION	CODE
-------------	------	-------------	------



bear
medium cherry (17) P007

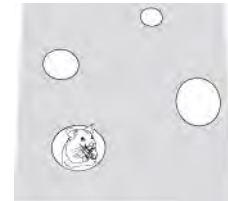

mouse
aegean (78) P008



fox
scarlet (83) P009



raccoon
transparent nocturne (81) P010



eagle
copper (22) P011

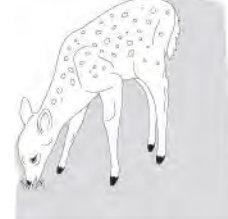

deer
terra (84) P012

SPECIFICATIONS CONTINUE ON NEXT PAGE

seat height

DESCRIPTION	CODE
12 inch seat height	SH12
14 inch seat height	SH14
15 inch seat height (wire sled base only)	SH15
16 inch seat height	SH16
13-16 inch seat height (task base only)	HATB

base type

DESCRIPTION	CODE
solid wood	W
4-leg steel	4
wire sled	S
task	T

Black five star task base on hard casters is height adjustable with tilt.

base finish

WOOD

Wood shell and wood base (excluding creature) is finished in Natural (11). Each creature's primary finish color is indicated in parenthesis on the previous page. Please note that freshcoast may use additional color to emphasize details and enhance the appearance of the creature.

4-LEG STEEL

DESCRIPTION	CODE
black	B
cool grey	CG
sterling	ST
warm grey	WG
white	W

WIRE SLED

DESCRIPTION	CODE
black	B
sterling	ST

TASK

DESCRIPTION	CODE
black	B

upholstered seat pad

Upholstery is Customer's Own Material (COM) requiring ½ yd. per chair.

Due to the design of this product, it is required that all non pre-approved textiles be tested for compatibility. Untested textiles will not be accepted. Contact freshcoast for yardage requirements on textiles with repeats.

Please refer to freshcoast Textile Program which features textiles and leathers from the following partners:

- Camira
- Carnegie
- CF Stinson
- Green Hides
- Maharam
- Unika Vaev

The complete grade list can be found at www.fc.studio/textile-partners or you can specify COM/COL. Due to the design of this product, it is recommended that all non pre-approved textile be tested for compatibility.

SPECIFICATIONS REQUIRED TO CREATE THE PRODUCT CODE

- + **Model**
- + **Shell Style**
- + **Seat Height**
- + **Base Type**
- + **Base Finish**
- + **upholstered seat pad (when applicable)**

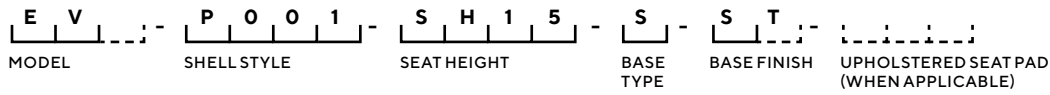

MODEL

Eve children's chair (EV)

SHELL STYLE

Wetland, Beaver (PO01)

SEAT HEIGHT

15 inch seat height (SH15)

BASE TYPE

Wire Sled (S)

BASE FINISH

Sterling (ST)



UPHOLSTERED SEAT PAD SELECTION

When applicable

12 inch seat height

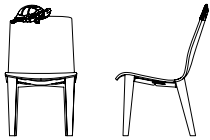

eve	model	list
12" seat height, solid wood base	EV-W	\$755

W15.5 D16.5 H23-27*

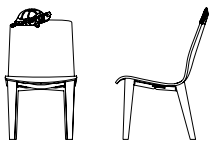

eve	model	com/col	a	b	c	d	e	f	g	h	i	j	k	l
12" seat height, solid wood base, upholstered seat pad	EVU-W	\$805	831	843	856	869	882	894	907	920	933	945	958	971

W15.5 D16.5 H23-27*

COM yardage: ½ yd.
Contact freshcoast customer care for COL requirements, textile testing requirements and yardage requirements for textiles with repeats.

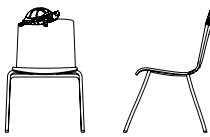

eve	model	list
12" seat height, four leg steel base	EV-4	\$588

W16.5 D18.75 H23-27*

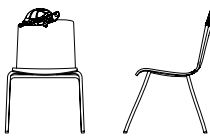

eve	model	com/col	a	b	c	d	e	f	g	h	i	j	k	l
12" seat height, four leg steel base, upholstered seat pad	EVU-4	\$689	715	728	741	754	767	780	793	806	819	832	845	858

W16.5 D18.75 H23-27*

COM yardage: ½ yd.
Contact freshcoast customer care for COL requirements, textile testing requirements and yardage requirements for textiles with repeats.

*overall chair height varies based upon the selected eve creature

to specify: please refer to pages 3-4 for complete specifying information. Specify all products by their product code.

pricing effective: July 15, 2021 10:52 AM

14 inch seat height

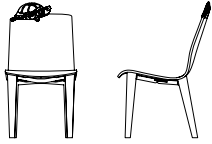

eve	model	list
14" seat height, solid wood base	EV-W	\$801

W15.75 D16.75 H25-29*

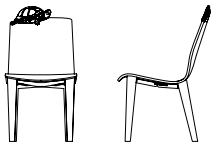

eve	model	com/col	a	b	c	d	e	f	g	h	i	j	k	l
14" seat height, solid wood base, upholstered seat pad	EVU-W	\$891	917	930	942	955	968	981	994	1007	1020	1033	1046	1059

W15.75 D16.75 H25-29*

COM yardage: ½ yd.
Contact freshcoast customer care for COL requirements, textile testing requirements and yardage requirements for textiles with repeats.

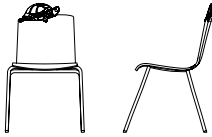

eve	model	list
14" seat height, four leg steel base	EV-4	\$609

W16.75 D19 H25-29*

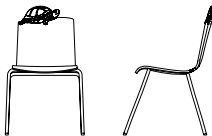

eve	model	com/col	a	b	c	d	e	f	g	h	i	j	k	l
14" seat height, four leg steel base, upholstered seat pad	EVU-4	\$712	738	751	764	777	790	803	816	829	842	855	868	881

W16.75 D19 H25-29*

COM yardage: ½ yd.
Contact freshcoast customer care for COL requirements, textile testing requirements and yardage requirements for textiles with repeats.

*overall chair height varies based upon the selected eve creature

to specify: please refer to pages 3-4 for complete specifying information. Specify all products by their product code.

pricing effective: July 15, 2021 10:52 AM

16 inch seat height

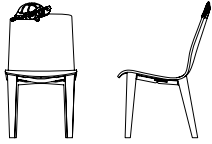

eve	model	list
16" seat height, solid wood base	EV-W	\$831

W16 D17 H27-31*

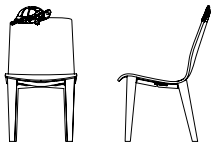

eve	model	com/col	a	b	c	d	e	f	g	h	i	j	k	l
16" seat height, solid wood base, upholstered seat pad	EVU-W	\$923	949	962	975	988	1001	1014	1027	1040	1053	1066	1079	1092

W16 D17 H27-31*

COM yardage: ½ yd.
Contact freshcoast customer care for COL requirements, textile testing requirements and yardage requirements for textiles with repeats.

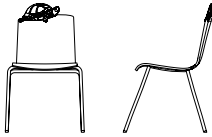

eve	model	list
16" seat height, four leg steel base	EV-4	\$642

W17 D19.25 H27-31*

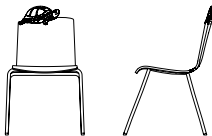

eve	model	com/col	a	b	c	d	e	f	g	h	i	j	k	l
16" seat height, four leg steel base, upholstered seat pad	EVU-4	\$742	768	781	794	807	820	833	846	859	872	885	898	911

W17 D19.25 H27-31*

COM yardage: ½ yd.
Contact freshcoast customer care for COL requirements, textile testing requirements and yardage requirements for textiles with repeats.

*overall chair height varies based upon the selected eve creature

to specify: please refer to pages 3-4 for complete specifying information. Specify all products by their product code.

pricing effective: July 15, 2021 10:52 AM

15 inch seat height - sled base

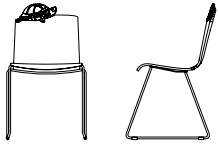

eve	model	list price/grade	list
15" seat height, wire sled base W16 D18.25 H24-25*	EV-S	black	\$693
		sterling	\$722

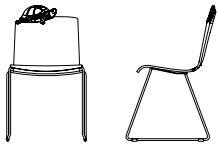

curve	model	list price/grade	com/col	a	b	c	d	e	f	g	h	i	j	k	l
15" seat height, wire sled base, upholstered seat pad W16 D18.25 H24-25*	EVU-S	black	\$794	820	833	846	859	872	885	898	911	924	937	950	963
		sterling	\$824	849	862	875	888	901	914	927	940	953	966	979	992

COM yardage: 1/2 yd.

Contact freshcoast customer care for COL requirements, textile testing requirements and yardage requirements for textiles with repeats.

*overall chair height varies based upon the selected eve creature

to specify: please refer to pages 3-4 for complete specifying information. Specify all products by their product code.

pricing effective: July 15, 2021 10:52 AM

13"-16" adjustable task base chair

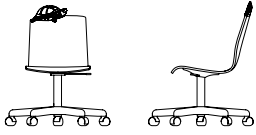

eve	model	list
13"-16" adjustable seat height, task base	EV-T	\$669
W22 D22 H23-31*		

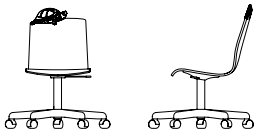

eve	model	com/col	a	b	c	d	e	f	g	h	i	j	k	l
13"-16" adjustable seat height, upholstered seat pad, task base	EVU-T	\$771	796	809	822	835	848	861	874	887	900	913	926	939
W22 D22 H23-31*		COM yardage: ½ yd. Contact freshcoast customer care for COL requirements, textile testing requirements and yardage requirements for textiles with repeats.												

*overall chair height varies based upon the selected eve creature

to specify: please refer to pages 3-4 for complete specifying information. Specify all products by their product code.

pricing effective: July 15, 2021 10:52 AM

freshcoast collection
HANDY STOOL

2021 Price List

Pricing Effective July 2021



handy children's stool price list

+ handy: table of contents HA2
+ handy specifications HA3
+ handy example..... HA4
+ handy stool HA5

model

DESCRIPTION	CODE
Handy Polypropylene	HFC-P

polypropylene shell

DESCRIPTION	CODE
White	WT
Black	BK
Grey	G
Yellow	YL
Orange	OR
Soda Red	SR
Blue	BU
Green	GN

CUSTOM POLYPROPYLENE COLORS

Custom color match is available upon request. Please contact hello@lelandinternational.com for further information

seat height

DESCRIPTION	CODE
12 inch seat height	SH12
14 inch seat height	SH14
16 inch seat height	SH16
17.5 inch seat height	SH17

glide options

DESCRIPTION	CODE
Poly (Standard)	S

stacking note

For Handy, ALL models stack as follows:

Floor: 10 High



	17.5"H	16"	14"	12"
stack of 10:	44"H	42.5"	40.5"	38.5"
stack of 5:	29.5"H	28"	26"	24"

SPECIFICATIONS REQUIRED TO CREATE THE PRODUCT CODE

- + **Model**
- + **Shell Finish**
- + **Seat Height**

H F C - **P** - **S H 1 7** - **W T**
MODEL SEAT HEIGHT COLOR

MODEL

Handy Stool (HFC-P)

SEAT HEIGHT

17.5 inch seat height

POLYPROPYLENE SHELL FINISH

White (WT)



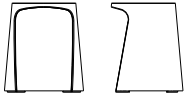

handy stool	model	list
polypropylene shell	HFC-P-SH17	\$167

W15.75 D14.25 H17.5

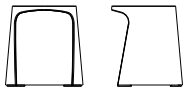

handy stool	model	list
polypropylene shell	HFC-P-SH16	\$167

W15.5 D14.25 H16



handy stool	model	list
polypropylene shell	HFC-P-SH14	\$167

W15.25 D14 H14



handy stool	model	list
polypropylene shell	HFC-P-SH12	\$167

W14.75 D13.75 H12

to specify: please refer to pages 3-4 for complete specifying information. Specify all products by their product code.

pricing effective: July 15, 2021 3:46 PM

freshcoast collection
**LITTLE MARQUETTE
CHAIR**

2021 Price List

Pricing Effective July 2021



little marquette chair pricelist

- + little marquette chair: table of contents MQ2
- + little marquette chair specifications MQ3
- + little marquette chair example MQ4
- + little marquette chair MQ5

model	code
DESCRIPTION Little Marquette chair	MQL

shell style	code
DESCRIPTION arc	A



DESCRIPTION crescent	C
--------------------------------	---







shell style
DESCRIPTION freshcoast Standard Wood Finishes custom (specify 01)

frame finish	code
DESCRIPTION Black	BK
Sterling	ST

glide options	code
DESCRIPTION Poly (Standard)	S
Felt	FC

edge type

SWAMP THINGS SERIES		code
	lizard	1S
	frog *cutout is off center	2S
	turtle *cutout is off center	3S
	snake	4S

edge type cont.		code
GEOMETRIC SERIES		

▲ ■ ● ▲ ■ shapes 1G

● circle 2G

■ square 3G

▲ triangle 4G

PETROGLYPH SERIES

 deer 1P

 antelope 2P

 lamb 3P

 horse 4P

CELESTIAL SERIES

 saturn 1C

 shooting star 2C

 starry night 3C

 moon 4C

specifications required to create the product code

- Model
- Shell Style
- Back Cut-Out
- Shell Finish
- Frame Finish
- Glide Type

M Q L - C - 1 S - 6 4 - S T - 1 ;
MODEL SHELL FINISH BACK CUT-OUT SHELL FINISH FRAME FINISH GLIDE TYPE

MODEL

Little Marquette Chair (MQL)

SHELL STYLE

Crescent (C)

BACK CUT-OUT

Lizard (1S)

SHELL FINISH

freshcoast finish,
sunflower (64)

FRAME FINISH

Sterling (ST)

GLIDE TYPE

Standard (S)



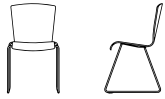

little marquette chair	model	list price
arc shell w16 d19 h28 sh15		
	powder coat frame	\$487
	chrome frame	\$519
	Optional Glides: Add \$8.00 net per chair for a set of four (4).	



little marquette chair	model	list price
crescent shell w16 d19 h28 sh15	ML-C	
	powder coat frame	\$487
	chrome frame	\$519
	Optional Glides: Add \$8.00 net per chair for a set of four (4).	

to specify: please refer to pages 3–4 for complete specifying information.
Specify all products by their product code.

freshcoast collection
**LITTLE MARQUETTE
TABLE**

2021 Price List

Pricing Effective July 2021



little marquette table pricelist

+ little marquette table: table of contents MT2
+ little marquette table specifications MT3
+ little marquette table example MT4
+ little marquette table MT5

model **code**

DESCRIPTION
Little Marquette chair MQL

leg finish **code**

DESCRIPTION
Black Powdercoat BK
Sterling Powdercoat ST

top size and shape

DESCRIPTION



round

code



square

code



rectangle

code

36 dia

36 D

36 x 36

3636

30 x 60

3060

42 dia

42D

42 x 42

4242

top finish or color

DESCRIPTION

wood tops

freshcoast Wood Finishes ([view here](#))
custom (specify 01)

DESCRIPTION

laminate tops

Identify manufacturer, laminate code, & color L

Please refer to the freshcoast Terms and Conditions Guide for a listing of standard laminates. For table pricing in laminates not listed, please contact freshcoast's Customer Experience Department for a quotation.

edge type **code**

DESCRIPTION
vinyl edges

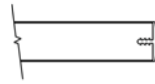

1 3/16" flat PVC

V2

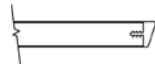

3/4" beveled PVC

V4

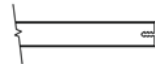

3/4" flat PVC

V5

wood edges



1" beveled plywood

W6



1" flat plywood

W2



1 3/16" beveled wood

W4

edge finish or color **code**

DESCRIPTION

vinyl edges

white

W

black

B

grey

G

DESCRIPTION

wood edges

freshcoast Wood Finishes ([view here](#))
custom (specify 01)

Please note that Marquette Tables are NOT AVAILABLE in the following finishes:

Natural Walnut Matte I08MI. Natural Beech I09I. Natural White Oak Matte I12MI

DESCRIPTION

self edges

For laminate tops, edge must be specified in the same laminate as top surface.

specifications required to create the product code

- Model
- Leg Finish
- Top Size
- Top Finish or Color
- Edge Type
- Edge Finish or Color

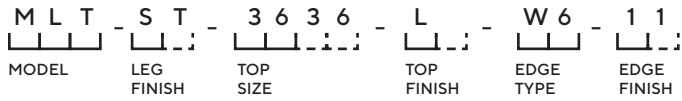

MODEL

Little Marquette Table (MLT)

LEG FINISH

Sterling Powdercoat (ST)

TOP SIZE

Square, 36 x 36" (3636)

TOP FINISH

Laminate (L)

EDGE TYPE

1" beveled plywood

EDGE FINISH

Natural (11)



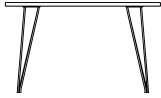

little marquette table

black base
h 25

model

MLT-B

top size/code

list price/edge codes

V6

W6

W2



round

36 dia

42 dia

48 dia



square

36x36

42x42

48x48



rectangle

30x60

wood top

36 dia - 36D

\$1358

1781

1781

42 dia - 42D

\$1420

1907

1907

48 dia - 48D

\$1748

1929

1929

36x36 - 3636

\$1369

1792

1792

42x42 - 4242

\$1440

1921

1921

48x48 - 4848

\$1775

1956

1956

30x60 - 3060

\$1509

1847

1847

laminate top

36 dia - 36D

\$1199

1507

1507

42 dia - 42D

\$1440

1662

1662

48 dia - 48D

\$1458

1691

1691

36x36 - 3636

\$1213

1521

1521

42x42 - 4242

\$1455

1683

1683

48x48 - 4848

\$1488

1722

1722

30x60 - 3060

\$1348

1534

1534

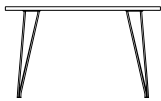

little marquette table

sterling base
h 25

model

MLT-ST

top size/code

list price/edge codes

V6

W6

W2



round

36 dia

42 dia

48 dia



square

36x36

42x42

48x48



rectangle

30x60

wood top

36 dia - 36D

\$1499

1921

1921

42 dia - 42D

\$1564

2048

2048

48 dia - 48D

\$1890

2074

2074

36x36 - 3636

\$1508

1934

1934

42x42 - 4242

\$1579

2062

2062

48x48 - 4848

\$1918

2102

2102

30x60 - 3060

\$1652

1988

1988

laminate top

36 dia - 36D

\$1350

1700

1700

42 dia - 42D

\$1559

1864

1864

48 dia - 48D

\$1570

1892

1892

36x36 - 3636

\$1365

1712

1712

42x42 - 4242

\$1589

1881

1881

48x48 - 4848

\$1602

1921

1921

30x60 - 3060

\$1554

1728

1728

to specify: please refer to pages 3-4 for complete specifying information.
Specify all products by their product code.

freshcoast collection

**MANITOU
CHILDREN'S CHAIR**

2021 Price List

Pricing Effective July 2021



freshcoast
by LELAND

manitou children's chair price list







- + manitou chair: table of contents MTC2
- + manitou chair specification information..... MTC3
- + manitou chair specification example MTC4
- + manitou chair shell art options MTC5-MTC6
- + manitou chair, 12 inch seat height..... MTC7
- + manitou chair, 14 inch seat height..... MTC8
- + manitou chair, 16 inch seat height..... MTC9
- + manitou chair, 15 inch seat height, sled base MTC10-MTC11
- + manitou chair, task base MTC12

model



DESCRIPTION	CODE
manitou children's chair, wood face	MTC
manitou children's chair, wood face, upholstered seat pad	MTCU
manitou children's chair, fully upholstered	MTFU

shell style

WOOD SHELL

DESCRIPTION	CODE	DESCRIPTION	CODE
Arch 	AH	Bump 	BP
Dip 	DP	Slant SL 	
Tilt 	TT	Wave 	WV

FULLY UPHOLSTERED SHELL

DESCRIPTION	CODE	DESCRIPTION	CODE
Bump 	BP	Dip 	DP

shell finish or color

TRANSPARENT FINISHES (SEMI-GLOSS SHEEN)

DESCRIPTION	CODE
natural	11
medium	13
neutral	15
classic mahogany	21
white wash II	30
espresso	23
transparent black	29
graphite	25

SEMI-TRANSPARENT FINISHES (MATTE-SHEEN)

DESCRIPTION	CODE
arctic II	16M
ink II	18M
limelight	33M
caribbean II	48M
soda red	46M
tangerine	40M
ice blue	47M
oxford II	49M
dolphin II	50M

shell art

Select shell art code from the shell art index [here](#) (pages 5 & 6).
Shell art is not available on fully upholstered models.

seat height

4-LEG STEEL BASE

DESCRIPTION	CODE
12 inch seat height	SH12
14 inch seat height	SH14
16 inch seat height	SH16

WIRE SLED BASE

DESCRIPTION	CODE
15 inch seat height	SH15

TASK BASE

DESCRIPTION	CODE
13-16 inch seat height (task base only)	HATB

Black five star task base on hard casters is height adjustable with tilt.

base finish

4-LEG STEEL AND WIRE SLED

DESCRIPTION	CODE	DESCRIPTION	CODE
sterling	ST	matte gold rush	MGR
warm grey	WG	matte mercury	MMR
cool grey	CG	matte mineral	MMN
black	B	matte burnish	MBN
white	W	matte foundry	MFN
		matte new penny	MNP

TASK

DESCRIPTION	CODE
black	B

upholstery

All upholstery is Customer's Own Material (COM).

Due to the design of this product, it is required that all non pre-approved textiles be tested for compatibility. Untested textiles will not be accepted. Contact freshcoast for yardage requirements on textiles with repeats.

Please refer to freshcoast Textile Program which features textiles and leathers from the following partners:

- Camira
- Carnegie
- CF Stinson
- Green Hides
- Maharam
- Unika Vaev

The complete grade list can be found at www.fc.studio.com/textile-partners or you can specify COM/COL. Due to the design of this product, it is recommended that all non pre-approved textile be tested for compatibility.

SPECIFICATIONS REQUIRED TO CREATE THE PRODUCT CODE

- + **Model**
- + **Shell Style**
- + **Shell Finish or Color**
- + **Shell Art (when applicable)**
- + **Seat Height**
- + **Base Finish**
- + **Upholstered Seat Pad (when applicable)**

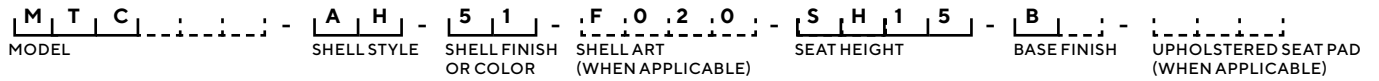

MODEL

Manitou children's chair (MTC)

SHELL STYLE

Arch (AH)

SHELL FINISH OR COLOR

Marigold (51)

SHELL ART

Celestial, Sun (F020)

SEAT HEIGHT

15 inch seat height (SH15)

BASE FINISH

Black (B)



UPHOLSTERED SEAT PAD SELECTION

When applicable

freshcoast shell art collections

Please refer to the freshcoast children’s brochure for details on scale and placement of shell art. If no shell art is desired, use code F999.

swamp things

grade 1

description
code



snake
(F001)



lizard
(F002)



tree frog
(F003)

*cutout is off
center



turtle
(F004)

*cutout is off
center

safari

grade 1

description
code



rhinoceros
(F005)



elephant
(F006)



lioness
(F007)



ostrich
(F008)



giraffe
(F009)

petroglyphs

grade 1

description
code



ram
(F010)



antelope
(F011)



deer
(F012)



caribou
(F013)



horse
(F014)

birds

grade 2

description
code



hummingbird
(F015)



owl
(F016)



woodpecker
(F017)



dove
(F018)

celestial

grade 1&2

description
code



moon
(F019)



sun
(F020)
grade 1



star
(F021)



saturn
(F022)



shooting star
(F023)
grade 2



moon among stars
(F024)

Original artwork is property of freshcoast Inc. All rights reserved. No part of this artwork may be reproduced or transmitted in any form or by any electronic means, including photocopying, or by any information or retrieval system, without written permission from the President or Director of freshcoast, Inc.

freshcoast shell art collections, continued

Please refer to the freshcoast children's brochure for details on scale and placement of shell art. If no shell art is desired, use code F999.

sea life
grade 1&2

description
code

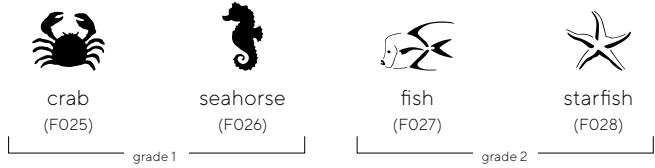

animal tracks
grade 2

description
code



shapes
grade 1

description
code

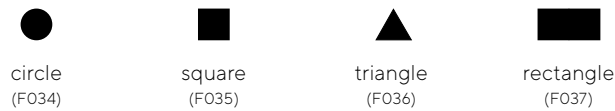

dinosaurs
grade 1

description
code



insects
grade 1&2

description
code

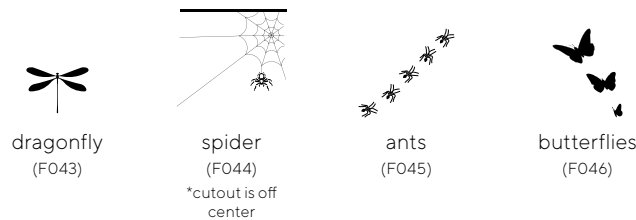

12 inch seat height

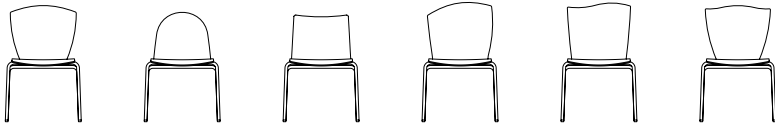

manitou four leg base	model	list price/grade	list
12" seat height, wood back	MTC-SH12	plain back	\$400
		grade 1 cutout	\$441
		grade 2 cutout	\$514

W16.5 D17.5-19* H24.5-27*

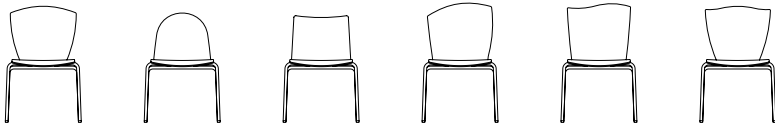

manitou four leg base	model	list price/grade	com/col	a	b	c	d	e	f	g	h	i	j	k	l
12" seat height, upholstered seat pad	MTCU-SH12	plain back	\$523	548	560	573	585	597	610	622	634	647	659	672	684
		grade 1 cutout	\$563	588	600	613	625	638	650	662	675	687	699	712	724
		grade 2 cutout	\$637	661	674	686	698	711	723	735	748	760	773	785	797

W16.5 D17.5-19* H24.5-27*

COM yardage: 1/2 yd.
Contact freshcoast customer care for COL requirements, textile testing requirements and yardage requirements for textiles with repeats.

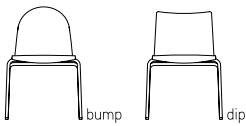

manitou four leg base	model	com/col	a	b	c	d	e	f	g	h	i	j	k	l
12" seat height, upholstered seat pad	MTFU-SH12	\$533	607	644	681	718	755	792	829	866	903	940	977	1015
		COM yardage: 1 1/2 yd. Contact freshcoast customer care for COL requirements, textile testing requirements and yardage requirements for textiles with repeats.												

BUMP W16.75 D19 H23.5
DIP W16.75 D19 H22

* dimension varies based upon the individual shell style

to specify: please refer to pages 3-4 for complete specifying information. Specify all products by their product code.

14 inch seat height

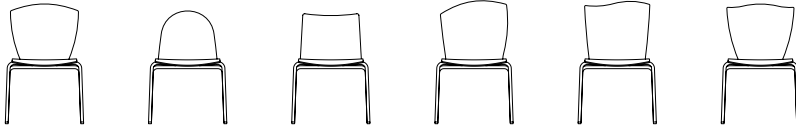

manitou four leg base	model	list price/grade	list
14" seat height, wood back W16.75 D18.5-20* H26.5-29*	MTC-SH14	plain back	\$403
		grade 1 cutout	\$444
		grade 2 cutout	\$517

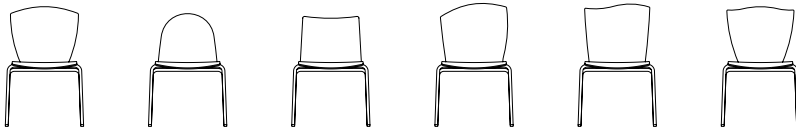

manitou four leg base	model	list price/grade	com/col	a	b	c	d	e	f	g	h	i	j	k	l
14" seat height, upholstered seat pad W16.75 D18.5-20* H26.5-29*	MTCU-SH14	plain back	\$525	550	562	575	587	599	612	624	637	649	661	674	686
		grade 1 cutout	\$568	592	605	617	629	642	654	666	679	691	703	716	728
		grade 2 cutout	\$642	666	679	691	703	716	728	741	753	765	778	790	802

COM yardage: ½ yd.
 Contact freshcoast customer care for COL requirements, textile testing requirements and yardage requirements for textiles with repeats.

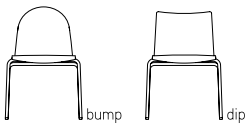

manitou four leg base	model	com/col	a	b	c	d	e	f	g	h	i	j	k	l
14" seat height, fully upholstered BUMP W16.75 D19 H25.5 DIP W16.75 D19 H24	MTFU-SH14	\$536	610	647	684	721	758	795	832	869	906	943	981	1018
		COM yardage: 1½ yd. Contact freshcoast customer care for COL requirements, textile testing requirements and yardage requirements for textiles with repeats.												

* dimension varies based upon the individual shell style

to specify: please refer to pages 3-4 for complete specifying information. Specify all products by their product code.

pricing effective: September 16, 2021 11:19 AM

16 inch seat height

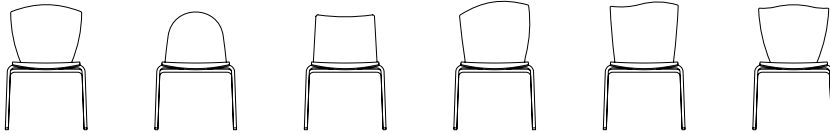

manitou four leg base	model	list price/grade	list
16" seat height, wood back W17 D19-20.5* H27.5-30*	MTC-SH16	plain back	\$405
		grade 1 cutout	\$447
		grade 2 cutout	\$520

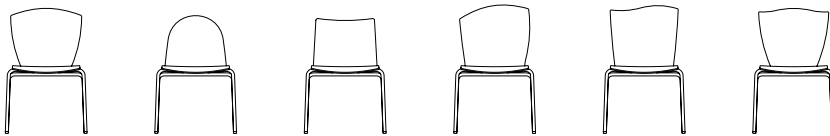

manitou four leg base	model	list price/grade	com/col	a	b	c	d	e	f	g	h	i	j	k	l
16" seat height, upholstered seat pad W17 D19-20.5* H27.5-30*	MTCU-SH16	plain back	\$527	552	564	577	589	602	614	626	639	651	663	676	688
		grade 1 cutout	\$570	594	607	619	631	644	656	668	681	693	706	718	730
		grade 2 cutout	\$644	668	681	693	706	718	730	743	755	767	780	792	804

COM yardage: ½ yd.
Contact freshcoast customer care for COL requirements, textile testing requirements and yardage requirements for textiles with repeats.

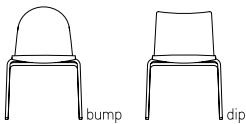

manitou four leg base	model	com/col	a	b	c	d	e	f	g	h	i	j	k	l
16" seat height, fully upholstered BUMP W16.75 D19 H27.5 DIP W16.75 D19 H26	MTFU-SH16	\$540	614	651	688	725	762	799	836	873	911	948	985	1022
		COM yardage: 1½ yd. Contact freshcoast customer care for COL requirements, textile testing requirements and yardage requirements for textiles with repeats.												

* dimension varies based upon the individual shell style

to specify: please refer to pages 3-4 for complete specifying information. Specify all products by their product code.

15 inch seat height - sled base



manitou sled base	model	list price/grade	list
15" seat height, wood back W17 D19-20.5* H27.5-30*	MTC-SH15	powder coat base	
		plain back	\$408
		grade 1 cutout	\$449
		grade 2 cutout	\$503



manitou sled base	model	list price/grade	com/col	a	b	c	d	e	f	g	h	i	j	k	l
15" seat height, sterling base, upholstered seat pad W17 D19-20.5* H27.5-30*	MTCU-SH15	powder coat base													
		plain back	\$531	556	569	581	593	606	618	630	643	655	667	680	692
		grade 1 cutout	\$573	597	610	622	634	647	659	672	684	696	709	721	733
		grade 2 cutout	\$605	629	642	654	666	679	691	703	716	728	741	753	765
COM yardage: 1/2 yd.															
Contact freshcoast customer care for COL requirements, textile testing requirements and															

* dimension varies based upon the individual shell style

to specify: please refer to pages 3-4 for complete specifying information. Specify all products by their product code.

pricing effective: September 16, 2021 11:19 AM

15 inch seat height - sled base



manitou sled base

model

com/col a b c d e f g h i j k l

**15" seat height,
wire sled base,
fully upholstered**

MTFU-SH15 powder coat base \$509 583 620 657 694 731 768 805 843 880 917 954 991

BUMP W16 D18 H25.5
DIP W16 D17.5 H24

COM yardage: 1½ yd.

Contact freshcoast customer care for COL requirements, textile testing requirements and yardage requirements for textiles with repeats.

13"-16" adjustable task base chair

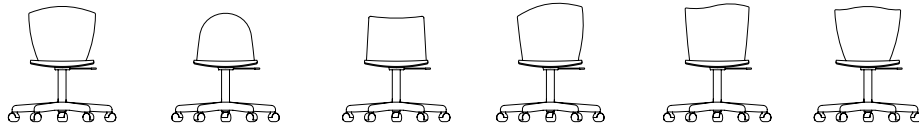

manitou task base	model	list price/grade	list
13-16" adjustable seat height, wood back, task base	MTC-HATB	plain back	\$436
		grade 1 cutout	\$478
		grade 2 cutout	\$509

W22 D22 H*

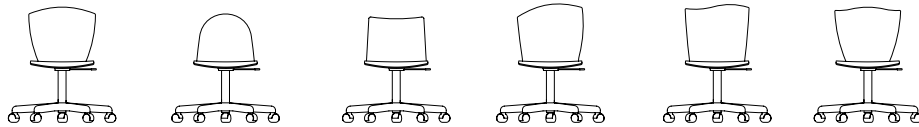

manitou task base	model	list price/grade	com/col	a	b	c	d	e	f	g	h	i	j	k	l
13-16" adjustable seat height, wood back, upholstered seat pad, task base	MTCU-HATB	plain back	\$559	584	596	609	621	633	646	658	671	683	695	708	720
		grade 1 cutout	\$602	626	639	651	663	676	688	700	713	725	737	750	762
		grade 2 cutout	\$632	657	670	682	694	707	719	731	744	756	768	781	793

W16.5 D17.5-19* H*

COM yardage: 1/2 yd.

Contact freshcoast customer car for COL requirements, textile testing requirements and yardage requirements for textiles with repeats.

*varies due to adjustable seat

to specify: please refer to pages 3-4 for complete specifying information. Specify all products by their product code.

freshcoast collection

**MANITOU
CHILDREN'S TABLE**

2021 Price List

Pricing Effective July 2021



freshcoast
by LELAND

manitou children's table price list

- + manitou table: table of contents MCT2
- + manitou table specification information MCT3
- + manitou table specification example MCT4
- + manitou table black base MCT5
- + manitou table sterling base MCT6

model

DESCRIPTION	CODE
Manitou children's table	MCT

base finish

DESCRIPTION	CODE
black	B
sterling	ST

top size

ROUND CODE	CODE	SQUARE	CODE	RECTANGLE	CODE
36 dia	36D	36x36	3636	30x60	3060
42 dia	42D	42x42	4242		
48 dia	48D	48x48	4848		

top surface finish or color

WOOD TOP:

TRANSPARENT FINISHES (SEMI-GLOSS SHEEN)

DESCRIPTION	CODE
natural	11
medium	13
neutral	15
classic mahogany	21
white wash II	30
espresso	23
transparent black	29
graphite	25

SEMI-TRANSPARENT FINISHES (MATTE-SHEEN)

DESCRIPTION	CODE
arctic II	16M
ink II	18M
limelight	33M
caribbean II	48M
soda red	46M
tangerine	40M
ice blue	47M
oxford II	49M
dolphin II	50M

top surface finish or color, cont.

LAMINATE TOP:

DESCRIPTION	CODE
Identify manufacturer, laminate code, & color	L

Please refer to the freshcoast Terms and Conditions for a listing of standard laminates. For table pricing in laminates not listed, please contact freshcoast for a quotation.

edge type

SOFT VINYL EDGE:

DESCRIPTION	CODE
13/16" flat PVC	V2

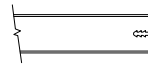

WOOD EDGE:

DESCRIPTION	CODE
1" flat plywood	W2



edge finish or color

SOFT VINYL EDGE:

DESCRIPTION	CODE
black	B
white	W
grey	G

WOOD EDGE:

Select from freshcoast Colors

Wood top with wood edge must be specified in the same finish.

Laminate top with wood edge may be specified in any freshcoast finish.

SPECIFICATIONS REQUIRED TO CREATE THE PRODUCT CODE

- + **Model**
- + **Base Finish**
- + **Top Size**
- + **Top Surface Finish or Color**
- + **Edge Type**
- + **Edge Finish or Color**

M C T - B - 3 6 3 6 - 7 4 - W 2 - 7 4
MODEL - BASE FINISH - TOP SIZE - TOP SURFACE FINISH OR COLOR - EDGE TYPE - EDGE FINISH OR COLOR

MODEL

Manitou children's table (MCT)

BASE FINISH

Black (B)

TOP SIZE

36 X 36 (3636)

TOP SURFACE FINISH OR COLOR

Concord (74)

EDGE TYPE

1 inch flat plywood (W2)

EDGE FINISH OR COLOR

Concord (74)

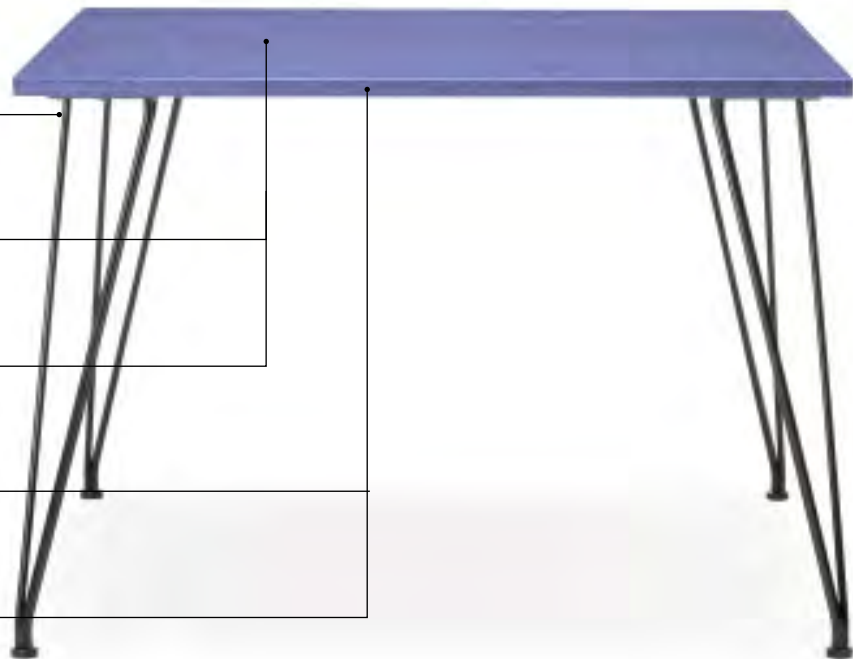

black powder coat base

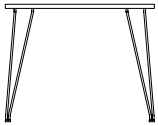

manitou table

4-leg steel black base
H25



model MCT-B

top size/code

list price/edge codes

V2

W2

		
round	square	rectangle
36 DIA	36 x 36	30 x 60
42 DIA	42 x 42	
48 DIA	48 x 48	

wood top

36 dia – 36D	\$1225	1610
42 dia – 42D	\$1280	1724
48 dia – 48D	\$1580	1744
36 x 36 – 3636	\$1233	1619
42 x 42 – 4242	\$1298	1738
48 x 48 – 4848	\$1606	1770
30 x 60 – 3060	\$1364	1669

laminite top

V6

36 dia – 36D	\$1080	1360
42 dia – 42D	\$1298	1501
48 dia – 48D	\$1316	1527
36 x 36 – 3636	\$1093	1373
42 x 42 – 4242	\$1312	1519
48 x 48 – 4848	\$1343	1556
30 x 60 – 3060	\$1215	1384



to specify: please refer to pages 3–4 for complete specifying information. Specify all products by their product code.

pricing effective: September 16, 2021 11:12 AM

MCT5

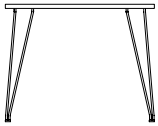
sterling powder coat base



manitou table	model	top size/code	list price/edge codes	V2	W2
4-leg steel sterling base H25	MCT-S	wood top			
 round		36 dia – 36D		\$1351	1738
 square		42 dia – 42D		\$1411	1852
 rectangle		48 dia – 48D		\$1710	1879
36 DIA	36 x 36	36 x 36 – 3636		\$1363	1749
42 DIA	42 x 42	42 x 42 – 4242		\$1426	1867
48 DIA	48 x 48	48 x 48 – 4848		\$1735	1903
		30 x 60 – 3060		\$1494	1798
		laminatE top		V6	
		36 dia – 36D		\$1218	1536
		42 dia – 42D		\$1406	1685
		48 dia – 48D		\$1417	1712
		36 x 36 – 3636		\$1230	1547
		42 x 42 – 4242		\$1437	1703
		48 x 48 – 4848		\$1445	1738
		30 x 60 – 3060		\$1404	1561

to specify: please refer to pages 3-4 for complete specifying information. Specify all products by their product code.

pricing effective: September 16, 2021 11:12 AM

freshcoast collection

**QUINCE
CHILDREN'S CHAIR**

2021 Price List

Pricing Effective July 2021



freshcoast
by LELAND

quince children's chair price list

- + quince chair: table of contents QC2
- + quince chair specification information QC3
- + quince chair specification example..... QC4
- + quince chair shell art..... QC5-QC6
- + quince 12 inch & 14 inch seat height..... QC7
- + quince 16 inch seat height & task base chair QC8

model

DESCRIPTION	CODE
Quince children's chair, wood face	QC
Quince children's chair, wood face, upholstered seat pad	QCU

shell style

WOOD SHELL

DESCRIPTION	CODE	DESCRIPTION	CODE
Horizon	H	Bump	BP

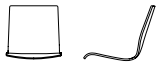

shell finish

TRANSPARENT FINISHES (SEMI-GLOSS SHEEN)

DESCRIPTION	CODE
natural	11
medium	13
neutral	15
classic mahogany	21
espresso	23
white wash II	30
transparent black	29
graphite	25

SEMI-TRANSPARENT FINISHES (MATTE-SHEEN)

DESCRIPTION	CODE
arctic ii	16M
ink ii	18M
limelight	33M
caribbean II	48M
soda red	46M
tangerine	40M
ice blue	47M
oxford II	49M
dolphin II	50M

shell art

Select shell art code from the shell art index [here](#) (pages 5 & 6).

seat height

DESCRIPTION	CODE
12 inch seat height, wood base	SH12
14 inch seat height, wood base	SH14
16 inch seat height, wood base	SH16
13-16 inch seat height (task base)	HATB

Black five star task base on hard casters is height adjustable with tilt.

base finish

WOOD

select from shell finish colors

TASK

DESCRIPTION	CODE
black	B

upholstered seat pad

Upholstery is Customer's Own Material (COM) requiring ½ yd. per chair.

Due to the design of this product, it is required that all non pre-approved textiles be tested for compatibility. Untested textiles will not be accepted. Contact freshcoast for yardage requirements on textiles with repeats.

Please refer to freshcoast Textile Program which features textiles and leathers from the following partners:

- Camira
- Carnegie
- CF Stinson
- Green Hides
- Maharam
- Unika Vaev

The complete grade list can be found at www.fc.studio/textile-partners or you can specify COM/COL. Due to the design of this product, it is recommended that all non pre-approved textile be tested for compatibility.

SPECIFICATIONS REQUIRED TO CREATE THE PRODUCT CODE

- + Model
- + Shell Style
- + Shell Finish
- + Shell Art
- + Seat Height
- + Base Finish
- + Upholstered Seat Pad (when applicable)

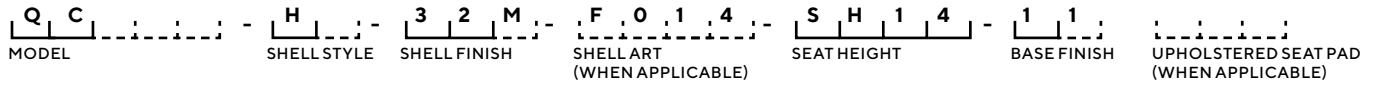

MODEL

Quince children's chair (QC)

SHELL STYLE

Horizon (H)

SHELL FINISH

Ink (32M)

SHELL ART

Petroglyph, Horse (F014)

SEAT HEIGHT

14 inch seat height (SH14)

BASE FINISH

Natural (11)



UPHOLSTERED SEAT PAD SELECTION

When applicable

freshcoast shell art collections

Please refer to the freshcoast children’s brochure for details on scale and placement of shell art. If no shell art is desired, use code F999.

swamp things
grade 1

description
code



snake
(F001)



lizard
(F002)



tree frog
(F003)
*cutout is off
center



turtle
(F004)
*cutout is off
center

safari
grade 1

description
code



rhinoceros
(F005)



elephant
(F006)



lioness
(F007)



ostrich
(F008)



giraffe
(F009)

petroglyphs
grade 1

description
code



ram
(F010)



antelope
(F011)



deer
(F012)



caribou
(F013)



horse
(F014)

birds
grade 2

description
code



hummingbird
(F015)



owl
(F016)



woodpecker
(F017)



dove
(F018)

celestial
grade 1&2

description
code



moon
(F019)



sun
(F020)
grade 1



star
(F021)



saturn
(F022)



shooting star
(F023)
grade 2



moon among stars
(F024)

Original artwork is property of freshcoast Inc. All rights reserved. No part of this artwork may be reproduced or transmitted in any form or by any electronic means, including photocopying, or by any information or retrieval system, without written permission from the President or Director of freshcoast, Inc.

freshcoast shell art collections, continued

Please refer to the freshcoast children's brochure for details on scale and placement of shell art. If no shell art is desired, use code F999.

sea life
grade 1&2

description
code

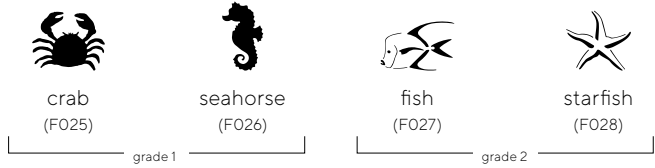

animal tracks
grade 2

description
code



shapes
grade 1

description
code

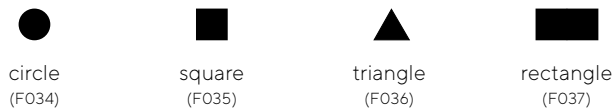

dinosaurs
grade 1

description
code



insects
grade 1&2

description
code

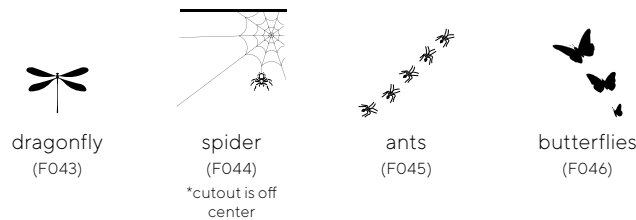

12 inch & 14 inch seat height

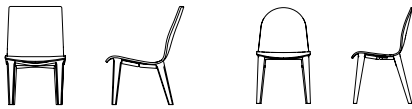

quince	model	list price/grade	list
12" children's chair, wood shell W15.5 D16.5 H23 SH12	QC-SH12	plain back	\$485
		grade 1 cutout	\$525
		grade 2 cutout	\$558

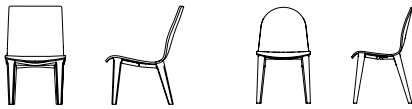

quince	model	list price/grade	com/col	a	b	c	d	e	f	g	h	i	j	k	l
12" children's chair, wood shell upholstered seat pad W15.5 D16.5 H23 SH12	QCU-SH12	plain back	\$608	632	645	657	670	682	694	707	719	731	744	756	768
		grade 1 cutout	\$649	674	686	698	711	723	735	748	760	773	785	797	810
		grade 2 cutout	\$681	706	718	730	743	755	767	780	792	804	817	829	842

COM yardage: ½ yd.
Contact freshcoast customer care for COL requirements, textile testing requirements and yardage requirements for textiles with repeats.

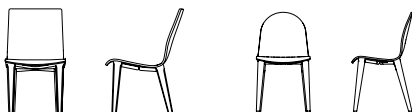

quince	model	list price/grade	list
14" children's chair, wood shell W16.75 D16.75 H25 SH14	QC-SH14	plain back	\$517
		grade 1 cutout	\$558
		grade 2 cutout	\$591

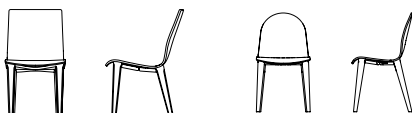

quince	model	list price/grade	com/col	a	b	c	d	e	f	g	h	i	j	k	l
14" children's chair, wood shell upholstered seat pad W16.75 D16.75 H25 SH14	QCU-SH14	plain back	\$642	666	679	691	703	716	728	741	753	765	778	790	802
		grade 1 cutout	\$681	706	718	730	743	755	767	780	792	804	817	829	842
		grade 2 cutout	\$715	740	752	764	777	789	801	814	826	838	851	863	876

COM yardage: ½ yd.
Contact freshcoast customer care for COL requirements, textile testing requirements and yardage requirements for textiles with repeats.

to specify: please refer to pages 3-4 for complete specifying information. Specify all products by their product code.

16 inch seat height & 13"-16" adjustable task base chair



quince	model	list price/grade	list
16" children's chair, wood shell W16 D17 H27 SH16	QC-SH16	plain back	\$550
		grade 1 cutout	\$591
		grade 2 cutout	\$623



quince	model	list price/grade	com/col	a	b	c	d	e	f	g	h	i	j	k	l
16" children's chair, wood shell upholstered seat pad W16 D17 H27 SH16	QCU-SH16	plain back	\$673	697	710	722	734	747	759	771	784	796	809	821	833
		grade 1 cutout	\$715	740	752	764	777	789	801	814	826	838	851	863	876
		grade 2 cutout	\$746	770	783	795	808	820	832	845	857	869	882	894	906

COM yardage: ½ yd.

Contact freshcoast customer care for COL requirements, textile testing requirements and yardage requirements for textiles with repeats.

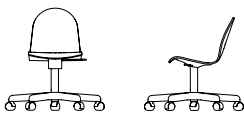

quince	model	list price/grade	list
13"-16" adjustable seat height, wood shell, task base W16.25 D16.25 H24	QC-HATB	plain back	\$578
		grade 1 cutout	\$620
		grade 2 cutout	\$652

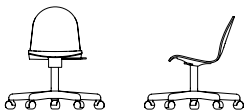

bow	model	list price/grade	com/col	a	b	c	d	e	f	g	h	i	j	k	l
13"-16" adjustable seat height, wood shell, upholstered seat pad, task base W16.25 D16.25 H24	QCU-HATB	plain back	\$701	726	739	751	763	776	788	800	813	825	837	850	862
		grade 1 cutout	\$742	766	779	791	803	816	828	840	853	865	878	890	902
		grade 2 cutout	\$775	799	812	824	836	849	861	873	886	898	911	923	935

COM yardage: ½ yd.

Contact freshcoast customer care for COL requirements, textile testing requirements and yardage requirements for textiles with repeats.

to specify: please refer to pages 3-4 for complete specifying information. Specify all products by their product code.

freshcoast collection

**QUINCE
CHILDREN'S TABLE**

2021 Price List

Pricing Effective July 2021



freshcoast
by LELAND

quince children's table price list

- + quince table: table of contents..... QCT2
- + quince table specification information QCT3
- + quince table specification example..... QCT4
- + quince 20"H table QCT5
- + quince 22"H table..... QCT6
- + quince 25"H table..... QCT7

model

DESCRIPTION	CODE
Quince children's table	QCT

table height

DESCRIPTION	CODE
20 inch table height	20H
22 inch table height	22H
25 inch table height	25H

top size

ROUND CODE	CODE	SQUARE	CODE	RECTANGLE	CODE
36 dia	36D	36x36	3636	30x60	3060
42 dia	42D	42x42	4242		
48 dia	48D	48x48	4848		

top surface finish or color

WOOD TOP:

TRANSPARENT FINISHES (SEMI-GLOSS SHEEN)

DESCRIPTION	CODE
natural	11
medium	13
neutral	15
classic mahogany	21
espresso	23
white wash II	30
transparent black	29
graphite	25

SEMI-TRANSPARENT FINISHES (MATTE-SHEEN)

DESCRIPTION	CODE
arctic ii	16M
ink ii	18M
limelight	33M
caribbean II	48M
soda red	46M
tangerine	40M
ice blue	47M
oxford II	49M
dolphin II	50M

top surface finish or color, cont.

LAMINATE TOP:

DESCRIPTION	CODE
Identify manufacturer, laminate code, & color	L

Please refer to the freshcoast Terms and Conditions for a listing of standard laminates. For table pricing in laminates not listed, please contact freshcoast for a quotation.

edge type

SOFT VINYL EDGE:

DESCRIPTION	CODE
13/16" flat PVC	V2



WOOD EDGE:

DESCRIPTION	CODE
1" flat plywood	W2



edge finish or color

SOFT VINYL EDGE:

DESCRIPTION	CODE
black	B
white	W
grey	G

WOOD EDGE:

Select from top surface colors

Wood top with wood edge must be specified in the same finish.

Laminate top with wood edge may be specified in any freshcoast finish

base finish

Select from top surface colors

SPECIFICATIONS REQUIRED TO CREATE THE PRODUCT CODE

- + **Model**
- + **Table Height**
- + **Base Finish**
- + **Top Size**
- + **Top Surface Finish or Color**
- + **Edge Type**
- + **Edge Finish or Color**

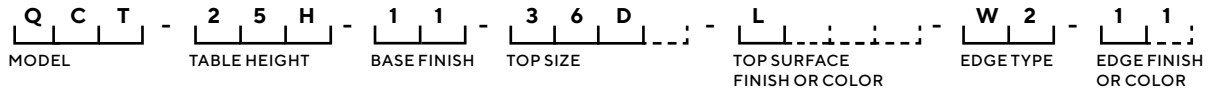

MODEL

Quince children's table (QCT)

TABLE HEIGHT

25 inch table height (25H)

BASE FINISH

Natural (11)

TOP SIZE

36 dia (36D)

TOP SURFACE FINISH OR COLOR

Laminate (L)

EDGE TYPE

1 inch flat plywood (W2)



EDGE FINISH OR COLOR

Natural (11)



20 inch height





quince table	model	top size/code	list price/edge codes	V2	W2
wood base H20	QCT-20H	wood top			
 round		36 dia – 36D		\$1010	1263
 square		42 dia – 42D		\$1063	1331
 rectangle		48 dia – 48D		\$1079	1348
36 DIA	36 x 36	36 x 36 – 3636		\$1016	1270
42 DIA	42 x 42	42 x 42 – 4242		\$1068	1337
48 DIA	48 x 48	48 x 48 – 4848		\$1085	1354
		30 x 60 – 3060		\$1044	1305
		laminate top			
		36 dia – 36D		\$909	1135
		42 dia – 42D		\$957	1197
		48 dia – 48D		\$970	1213
		36 x 36 – 3636		\$914	1142
		42 x 42 – 4242		\$961	1203
		48 x 48 – 4848		\$979	1223
		30 x 60 – 3060		\$941	1175

to specify: please refer to pages 3-4 for complete specifying information. Specify all products by their product code.

pricing effective: September 8, 2021 2:36 PM

22 inch height





quince table	model	top size/code	list price/edge codes	V2	W2
wood base H22	QCT-22H	wood top			
 round		36 dia – 36D		\$1029	1286
 square		42 dia – 42D		\$1085	1354
 rectangle		48 dia – 48D		\$1101	1376
36 DIA	36 x 36	36 x 36 – 3636		\$1035	1296
42 DIA	42 x 42	42 x 42 – 4242		\$1092	1364
48 DIA	48 x 48	48 x 48 – 4848		\$1106	1383
		30 x 60 – 3060		\$1065	1333
		laminate top			
		36 dia – 36D		\$926	1159
		42 dia – 42D		\$979	1223
		48 dia – 48D		\$991	1237
		36 x 36 – 3636		\$932	1165
		42 x 42 – 4242		\$983	1228
		48 x 48 – 4848		\$995	1245
		30 x 60 – 3060		\$958	1199

to specify: please refer to pages 3-4 for complete specifying information. Specify all products by their product code.

pricing effective: September 8, 2021 2:36 PM

25 inch height



quince table		model	top size/code	list price/edge codes	V2	W2
wood base		QCT-25H	wood top			
H25			36 dia – 36D		\$1051	1312
			42 dia – 42D		\$1106	1383
round	square		48 dia – 48D		\$1123	1404
			36 x 36 – 3636		\$1057	1321
36 DIA	36 x 36		42 x 42 – 4242		\$1112	1391
	30 x 60		48 x 48 – 4848		\$1128	1411
42 DIA	42 x 42		30 x 60 – 3060		\$1086	1357
			laminate top			
48 DIA	48 x 48		36 dia – 36D		\$946	1180
			42 dia – 42D		\$995	1245
			48 dia – 48D		\$1010	1264
			36 x 36 – 3636		\$951	1189
			42 x 42 – 4242		\$1002	1250
		48 x 48 – 4848		\$1017	1270	
		30 x 60 – 3060		\$980	1224	

to specify: please refer to pages 3-4 for complete specifying information. Specify all products by their product code.

pricing effective: September 8, 2021 2:36 PM

freshcoast collection

**ZOON
CHILDREN'S CHAIR**

2021 Price List

Pricing Effective July 2021



fc

freshcoast
by LELAND

zoon children's chair price list

- + zoon chair: table of contents ZNC2
- + zoon chair specification information..... ZNC3
- + zoon chair specification example ZNC4
- + zoon chair art..... ZNC5-ZNC6
- + zoon 12 inch & 14 inch seat height chair..... ZNC7
- + zoon 16 inch seat height & task base chair..... ZNC8

model

DESCRIPTION	CODE
Zoon children's chair, wood face	ZNC
Zoon children's chair, upholstered seat pad	ZNCU

shell style

DESCRIPTION	CODE	DESCRIPTION	CODE
Round	R	Square	S
			

shell finish

FRESHCOAST TRANSPARENT FINISHES (SEMI-GLOSS SHEEN)		FRESHCOAST SEMI-TRANSPARENT FINISHES (MATTE-SHEEN)	
DESCRIPTION	CODE	DESCRIPTION	CODE
natural	11	arctic ii	16M
medium	13	ink ii	18M
neutral	15	limelight	33M
classic mahogany	21	caribbean II	48M
espresso	23	soda red	46M
white wash II	30	tangerine	40M
transparent black	29	ice blue	47M
graphite	25	oxford II	49M
		dolphin II	50M

shell art

Select shell art code from the shell art index [here](#) (pages 5 & 6).

insects, spider (F044) is not available on round shells.

seat height

DESCRIPTION	CODE
12 inch seat height, steel four leg	SH12
14 inch seat height, steel four leg	SH14
16 inch seat height, steel four leg	SH16
13-16 inch seat height (task base only)	HATB

Black five star task base on hard casters is height adjustable with tilt.

base finish

STEEL FOUR LEG

DESCRIPTION	CODE
black	B
cool grey	CG
sterling	ST
warm grey	WG
white	W

TASK

DESCRIPTION	CODE
black	B

glide color

DESCRIPTION	CODE
red	R
yellow	Y
blue	BL
grey	G
black	B

upholstered seat pad

Upholstery is Customer's Own Material (COM) requiring ½ yd. per chair.

Due to the design of this product, it is required that all non pre-approved textiles be tested for compatibility. Untested textiles will not be accepted. Contact freshcoast for yardage requirements on textiles with repeats.

Please refer to freshcoast Textile Program which features textiles and leathers from the following partners:

- Camira
- Carnegie
- CF Stinson
- Green Hides
- Maharam
- Unika Vaev

The complete grade list can be found at www.fc.studio/textile-partners or you can specify COM/COL. Due to the design of this product, it is recommended that all non pre-approved textile be tested for compatibility.

SPECIFICATIONS REQUIRED TO CREATE THE PRODUCT CODE

- + Model
- + Shell Style
- + Shell Finish
- + Shell Art (when applicable)
- + Seat Height
- + Base Finish
- + Glide Color (when applicable)
- + Upholstered Seat Pad (when applicable)



MODEL

Zoon children's chair (ZNC)

SHELL STYLE

Square (S)

SHELL FINISH

Natural (11)

SHELL ART

Celestial, Saturn (F022)

SEAT HEIGHT

14 inch seat height (SH14)

BASE FINISH

White (W)

GLIDE COLOR

Yellow (Y)



UPHOLSTERED SEAT PAD SELECTION

When applicable

freshcoast shell art collections

Please refer to the freshcoast children's brochure for details on scale and placement of shell art. If no shell art is desired, use code F999.

swamp things

grade 1

description
code



snake
(F001)



lizard
(F002)



tree frog
(F003)

*cutout is off
center



turtle
(F004)

*cutout is off
center

safari

grade 1

description
code



rhinoceros
(F005)



elephant
(F006)



lioness
(F007)



ostrich
(F008)



giraffe
(F009)

petroglyphs

grade 1

description
code



ram
(F010)



antelope
(F011)



deer
(F012)



caribou
(F013)



horse
(F014)

birds

grade 2

description
code



hummingbird
(F015)



owl
(F016)



woodpecker
(F017)



dove
(F018)

celestial

grade 1&2

description
code



moon
(F019)



sun
(F020)
grade 1



star
(F021)



saturn
(F022)



shooting star
(F023)
grade 2



moon among stars
(F024)

Original artwork is property of freshcoast Inc. All rights reserved. No part of this artwork may be reproduced or transmitted in any form or by any electronic means, including photocopying, or by any information or retrieval system, without written permission from the President or Director of freshcoast, Inc.

freshcoast shell art collections, continued

Please refer to the freshcoast children's brochure for details on scale and placement of shell art. If no shell art is desired, use code F999.

sea life
grade 1&2

description
code

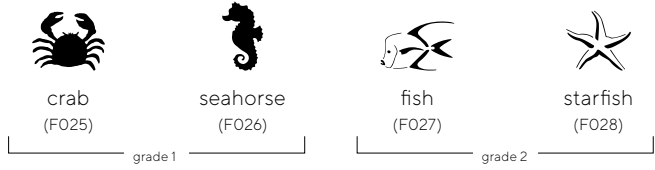

animal tracks
grade 2

description
code



shapes
grade 1

description
code

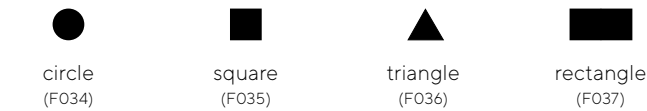

dinosaurs
grade 1

description
code



insects
grade 1&2

description
code

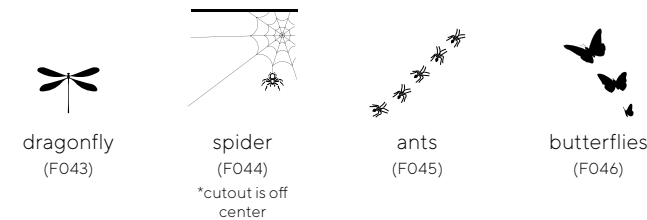

Original artwork is property of freshcoast Inc. All rights reserved. No part of this artwork may be reproduced or transmitted in any form or by any electronic means, including photocopying, or by any information or retrieval system, without written permission from the President or Director of freshcoast, Inc.

12 inch & 14 inch seat height

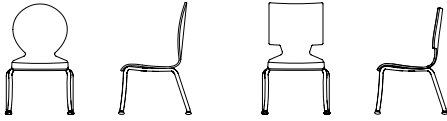

zoon	model	list price/grade	list
12" children's chair, wood shell ROUND W17.25 D16.25 H26.25 SH12 SQUARE W17.25 D16.25 H24.75 SH12	ZNC	plain back	\$334
		grade 1 cutout	\$376
		grade 2 cutout	\$408



zoon	model	list price/grade	com/col	a	b	c	d	e	f	g	h	i	j	k	l
12" children's chair, wood shell upholstered seat pad ROUND W17.25 D16.25 H26.25 SH12 SQUARE W17.25 D16.25 H24.75 SH12	ZNCU	plain back	\$431	455	468	480	492	505	517	529	542	554	567	579	591
		grade 1 cutout	\$471	495	508	520	533	545	557	570	582	594	607	619	631
		grade 2 cutout	\$504	528	541	553	565	578	590	603	615	627	640	652	664

COM yardage: 1/2 yd.
 Contact freshcoast customer care for COL requirements, textile testing requirements and yardage requirements for textiles with repeats.

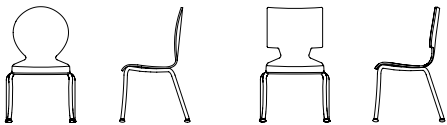

zoon	model	list price/grade	list
14" children's chair, wood shell ROUND W17.5 D16.5 H28.25 SH14 SQUARE W17.5 D16.5 H26.75 SH14	ZNC	plain back	\$358
		grade 1 cutout	\$400
		grade 2 cutout	\$433

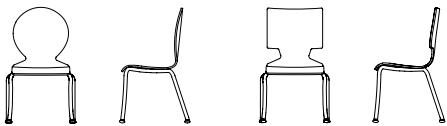

zoon	model	list price/grade	com/col	a	b	c	d	e	f	g	h	i	j	k	l
14" children's chair, wood shell upholstered seat pad ROUND W17.5 D16.5 H28.25 SH14 SQUARE W17.5 D16.5 H26.75 SH14	ZNCU	plain back	\$456	481	493	506	518	530	543	555	568	580	592	605	617
		grade 1 cutout	\$497	522	535	547	559	572	584	596	609	621	633	646	658
		grade 2 cutout	\$530	555	568	580	592	605	617	629	642	654	666	679	691

COM yardage: 1/2 yd.
 Contact freshcoast customer care for COL requirements, textile testing requirements and yardage requirements for textiles with repeats.

to specify: please refer to pages 3-4 for complete specifying information. Specify all products by their product code.

16 inch seat height & 13"-16" adjustable task base chair

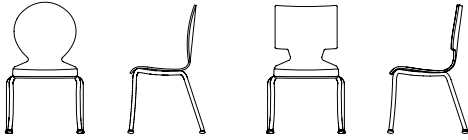

curve	model	list price/grade	list
16" children's chair, wood shell ROUND W17.75 D16.75 H30.25 SH16 SQUARE W17.75 D16.75 H28.75 SH16	ZNC	plain back	\$393
		grade 1 cutout	\$435
		grade 2 cutout	\$467

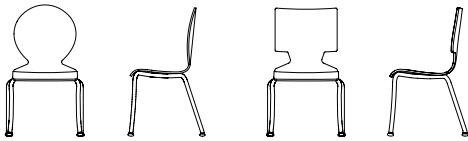

curve	model	list price/grade	com/col	a	b	c	d	e	f	g	h	i	j	k	l
16" children's chair, wood shell upholstered seat pad ROUND W17.75 D16.75 H30.25 SH16 SQUARE W17.75 D16.75 H28.75 SH16	ZNCU	plain back	\$490	515	527	540	552	564	577	589	602	614	626	639	651
		grade 1 cutout	\$533	557	570	582	594	607	619	631	644	656	668	681	693
		grade 2 cutout	\$563	588	600	613	625	638	650	662	675	687	699	712	724

COM yardage: 1/2 yd.
 Contact freshcoast customer care for COL requirements, textile testing requirements and yardage requirements for textiles with repeats.

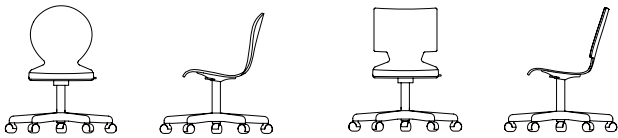

bow	model	list price/grade	list
13"-16" adjustable seat height, wood shell, task base ROUND W22 D22 H27.25-30.25 SQUARE W22 D22 H25.75-28.75	ZNC	plain back	\$457
		grade 1 cutout	\$499
		grade 2 cutout	\$531

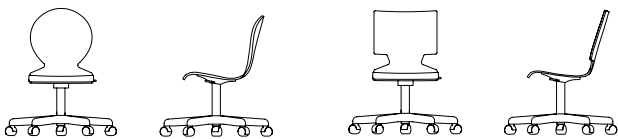

bow	model	list price/grade	com/col	a	b	c	d	e	f	g	h	i	j	k	l
13"-16" adjustable seat height, wood shell, upholstered seat pad, task base ROUND W22 D22 H27.25-30.25 SQUARE W22 D22 H25.75-28.75	ZNCU	plain back	\$553	578	590	603	615	627	640	652	664	677	689	701	714
		grade 1 cutout	\$595	620	632	645	657	670	682	694	707	719	731	744	756
		grade 2 cutout	\$626	651	663	676	688	700	713	725	737	750	762	775	787

COM yardage: 1/2 yd.
 Contact freshcoast customer care for COL requirements, textile testing requirements and yardage requirements for textiles with repeats.

to specify: please refer to pages 3-4 for complete specifying information. Specify all products by their product code.

freshcoast collection
ZOON
CHILDREN'S STOOL

2021 Price List

Pricing Effective July 2021

fc freshcoast
by LELAND

zoon children's stool price list

- + zoon stool: table of contents ZNS2
- + zoon stool specification information ZNS3
- + zoon stool specification example ZNS4
- + zoon 12 inch & 14 inch seat height stool..... ZNS5
- + zoon 16 inch seat height stool ZNS6

model

DESCRIPTION	CODE
Zoon stool	ZNS

seat height

DESCRIPTION	CODE
12 inch seat height, steel four leg	SH12
14 inch seat height, steel four leg	SH14
16 inch seat height, steel four leg	SH16

base finish

DESCRIPTION	CODE	DESCRIPTION	CODE
black	B	matte mineral	MMN
cool grey	CG	matte new penny	MNP
matte burnish	MBN	sterling	ST
matte foundry	MFN	warm grey	WG
matte gold rush	MGR	white	W
matte mercury	MMR		

seat finish or color

WOOD SEAT:

FRESHCOAST TRANSPARENT FINISHES (SEMI-GLOSS SHEEN)

DESCRIPTION	CODE
natural	11
medium	13
neutral	15
classic mahogany	21
espresso	23
white wash II	30
transparent black	29
graphite	25

FRESHCOAST SEMI-TRANSPARENT FINISHES (MATTE-SHEEN)

DESCRIPTION	CODE
arctic ii	16M
ink ii	18M
limelight	33M
caribbean II	48M
soda red	46M
tangerine	40M
ice blue	47M
oxford II	49M
dolphin II	50M

seat finish or color, cont.

LAMINATE SEAT:

DESCRIPTION	CODE
Identify manufacturer, laminate code, & color	L

Please refer to the freshcoast Terms and Conditions for a listing of standard laminates. For table pricing in laminates not listed, please contact freshcoast for a quotation.

UPHOLSTERED SEAT:

DESCRIPTION	CODE
Customer's Own Material	COM

Upholstery is Customer's Own Material (COM) requiring ½ yd. per chair.

Due to the design of this product, it is required that all non pre-approved textiles be tested for compatibility. Untested textiles will not be accepted. Contact freshcoast for yardage requirements on textiles with repeats.

Please refer to freshcoast Textile Program which features textiles and leathers from the following partners:

- Brentano
- Camira
- Carnegie
- CF Stinson
- Green Hides
- Maharam
- Unika Vaev

The complete grade list can be found at www.fc.studio/textile-partners or you can specify COM/COL. Due to the design of this product, it is recommended that all non pre-approved textile be tested for compatibility.

edge type

WOOD EDGE:

DESCRIPTION	CODE
1" flat plywood	W2



*upholstered seat does not require an edge selection

edge finish or color

Select from freshcoast Colors I & II.

Wood seat with wood edge must be specified in the same finish.

Laminate seat with wood edge may be specified in any freshcoast finish

glide color

DESCRIPTION	CODE
red	R
yellow	Y
blue	BL
grey	G
black	B

SPECIFICATIONS REQUIRED TO CREATE THE PRODUCT CODE

- + **Model**
- + **Seat Height**
- + **Base Finish**
- + **Seat Finish / Color / Upholstery**
- + **Edge Type (when applicable)**
- + **Edge Finish or Color (when applicable)**
- + **Glide Color**



MODEL

Zoon stool (ZNS)

SEAT HEIGHT

16 inch seat height (SH16)

BASE FINISH

White (W)

SEAT FINISH / COLOR / UPHOLSTERY

Upholstered (COM)

EDGE TYPE

When applicable

EDGE FINISH OR COLOR

When applicable

GLIDE COLOR

Red (R)



12 inch & 14 inch seat height

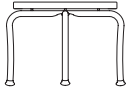

zoon stool	model	list price/grade	list price/edge codes	W2
12 inch seat height, steel four leg base	ZNS-SH12	wood seat		\$264
		laminate seat		\$269

W17.5 D17.5 H12

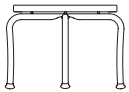

zoon stool	model	list price/grade	com/col	a	b	c	d	e	f	g	h	i	j	k	l
12 inch seat height, steel four leg base, upholstered seat	ZNS-SH12	upholstered seat	\$359	384	397	409	421	434	446	458	471	483	495	508	520
		COM yardage: ½ yd. Contact freshcoast customer care for COL requirements, textile testing requirements and yardage requirements for textiles with repeats.													

W17.5 D17.5 H12

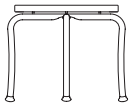

zoon stool	model	list price/grade	list price/edge codes	W2
12 inch seat height, steel four leg base	ZNS-SH14	wood seat		\$272
		laminate seat		\$276

W17.8 D17.8 H14

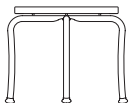

zoon stool	model	list price/grade	com/col	a	b	c	d	e	f	g	h	i	j	k	l
12 inch seat height, steel four leg base, upholstered seat	ZNS-SH14	upholstered seat	\$369	393	406	418	431	443	455	468	480	492	505	517	529
		COM yardage: ½ yd. Contact freshcoast customer care for COL requirements, textile testing requirements and yardage requirements for textiles with repeats.													

W17.8 D17.8 H14

to specify: please refer to pages 3-4 for complete specifying information. Specify all products by their product code.

16 inch seat height

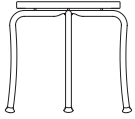

zoon stool	model	list price/grade	list price/edge codes	W2
16 inch seat height, steel four leg base	ZNS-SH16	wood seat		\$280
		laminated seat		\$282

W18.35 D18.35 H16



zoon stool	model	list price/grade	com/col	a	b	c	d	e	f	g	h	i	j	k	l
16 inch seat height, steel four leg base, upholstered seat	ZNS-SH16	upholstered seat	\$377	402	414	426	439	451	464	476	488	501	513	525	538

W18.35 D18.35 H16

COM yardage: 1/2 yd.

Contact freshcoast customer care for COL requirements, textile testing requirements and yardage requirements for textiles with repeats.

to specify: please refer to pages 3-4 for complete specifying information. Specify all products by their product code.

pricing effective: July 15, 2021 4:44 PM

12 inch seat height

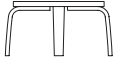

curve	model	list price/grade	list price/edge codes	V2	W2
12" stool, curved plywood base, wood seat	CYS-SH12				
		18 dia – 18D		\$542	542
		26 dia – 26D		\$581	581
		36 dia – 36D		\$612	612

W16.25 D16.25 H24



round

18 DIA

26 DIA

36 DIA

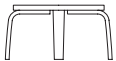

curve	model	list price/grade	com/col	a	b	c	d	e	f	g	h	i	j	k	l
12" stool, curved plywood base, upholstered seat	CYS-SH12														
		18 dia – 18D	\$658	682	694	706	718	730	742	754	766	778	790	802	814
		26 dia – 26D	\$658	682	694	706	718	730	742	754	766	778	790	802	814
		36 dia – 36D	\$658	682	694	706	718	730	742	754	766	778	790	802	814

W16.25 D16.25 H24



round

18 DIA

26 DIA

36 DIA

COM yardage: 18 dia: ¾ yd, 26 dia: 1 yd, 36 dia 1½ yds
 Contact Leland customer experience for COL requirements, textile testing requirements and yardage requirements for textiles with repeats.

to specify: please refer to pages 3–4 for complete specifying information. Specify all products by their product code.

pricing effective: July 15, 2021 4:44 PM

freshcoast collection
**ZOON
CHILDREN'S TABLE**

2021 Price List

Pricing Effective July 2021



freshcoast
by LELAND

zoon children's table price list

- + zoon table: table of contents ZNT2
- + zoon table specification information ZNT3
- + zoon table specification example ZNT4
- + zoon tables ZNT5

model

DESCRIPTION	CODE
Zoon children's table	ZNT

table height

DESCRIPTION	CODE
20 inch table height	20H
22 inch table height	22H
25 inch table height	25H

base finish

DESCRIPTION	CODE	DESCRIPTION	CODE
black	B	slate	S
chardonnay	CD	sterling	ST
cool grey	CG	warm grey	WG
java	JV	white	W
matte black	MB		

top size

ROUND CODE	CODE	SQUARE	CODE	RECTANGLE	CODE
36 dia	36D	36x36	3636	30x60	3060
42 dia	42D	42x42	4242		
48 dia	48D	48x48	4848		

top surface finish or color

WOOD TOP:

FRESHCOAST TRANSPARENT FINISHES (SEMI-GLOSS SHEEN)

DESCRIPTION	CODE
natural	11
medium	13
neutral	15
classic mahogany	21
espresso	23
white wash II	30
transparent black	29
graphite	25

FRESHCOAST SEMI-TRANSPARENT FINISHES (MATTE-SHEEN)

DESCRIPTION	CODE
arctic ii	16M
ink ii	18M
limelight	33M
caribbean II	48M
soda red	46M
tangerine	40M
ice blue	47M
oxford II	49M
dolphin II	50M

top surface finish or color, cont.

LAMINATE TOP:

DESCRIPTION	CODE
Identify manufacturer, laminate code, & color	L

Please refer to the freshcoast Terms and Conditions for a listing of standard laminates. For table pricing in laminates not listed, please contact freshcoast for a quotation.

edge type

SOFT VINYL EDGE:

DESCRIPTION	CODE
13/16" flat PVC	V2



WOOD EDGE:

DESCRIPTION	CODE
1" flat plywood	W2



edge finish or color

SOFT VINYL EDGE:

DESCRIPTION	CODE
black	B
white	W
grey	G
red	R
blue	BL
yellow	Y

WOOD EDGE:

Select from freshcoast Colors I & II.

Wood top with wood edge must be specified in the same finish. Laminate top with wood edge may be specified in any freshcoast finish

glide color

DESCRIPTION	CODE
red	R
yellow	Y
blue	BL
cool grey	CG
black	B

SPECIFICATIONS REQUIRED TO CREATE THE PRODUCT CODE

- + **Model**
- + **Table Height**
- + **Base Finish**
- + **Top Size**
- + **Top Surface Finish or Color**
- + **Edge Type**
- + **Edge Finish or Color**
- + **Glide Color**

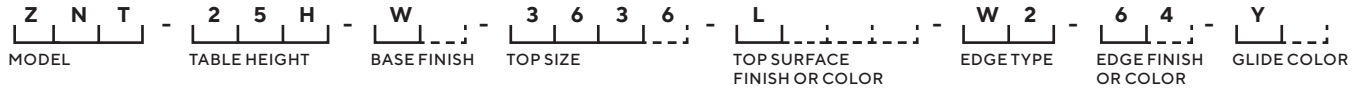

MODEL

Zoon children's table (ZNT)

TABLE HEIGHT

25 inch table height (25H)

BASE FINISH

White (W)

TOP SIZE

36 dia (36D)

TOP SURFACE FINISH OR COLOR

Laminate (L)

EDGE TYPE

1 inch flat plywood (W2)

EDGE FINISH OR COLOR

Sunflower (64)



GLIDE COLOR

Yellow (Y)



20 inch height





zoon table		model	top size/code	list price/edge codes	V2	W2
steel base		ZNT-20H	wood top			
H20			36 dia – 36D		\$1140	1426
			42 dia – 42D		\$1195	1494
round	square		48 dia – 48D		\$1210	1514
			36 x 36 – 3636		\$1147	1433
36 DIA	36 x 36		42 x 42 – 4242		\$1201	1500
42 DIA	42 x 42		48 x 48 – 4848		\$1215	1520
48 DIA	48 x 48		30 x 60 – 3060		\$1175	1469
			laminite top			
			36 dia – 36D		\$969	1212
		42 dia – 42D		\$1017	1270	
		48 dia – 48D		\$1028	1285	
		36 x 36 – 3636		\$974	1217	
		42 x 42 – 4242		\$1021	1275	
		48 x 48 – 4848		\$1033	1292	
		30 x 60 – 3060		\$998	1248	

to specify: please refer to pages 3-4 for complete specifying information. Specify all products by their product code.

pricing effective: July 15, 2021 4:57 PM

22 inch height







zoon table		model	top size/code	list price/edge codes	V2	W2
steel base		ZNT-22H	wood top			
H22			36 dia – 36D		\$1170	1461
			42 dia – 42D		\$1226	1530
round	square		48 dia – 48D		\$1240	1552
			36 x 36 – 3636		\$1175	1469
36 DIA	36 x 36	rectangle	42 x 42 – 4242		\$1231	1539
42 DIA	42 x 42		48 x 48 – 4848		\$1246	1558
48 DIA	48 x 48		30 x 60 – 3060		\$1206	1506
			laminite top			
			36 dia – 36D		\$994	1241
			42 dia – 42D		\$1041	1301
			48 dia – 48D		\$1055	1317
			36 x 36 – 3636		\$998	1248
			42 x 42 – 4242		\$1046	1307
			48 x 48 – 4848		\$1060	1325
			30 x 60 – 3060		\$1024	1279

to specify: please refer to pages 3-4 for complete specifying information. Specify all products by their product code.

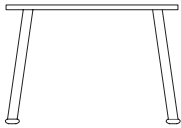
pricing effective: July 15, 2021 4:57 PM

25 inch height



zoon table		model	top size/code	list price/edge codes	V2	W2
steel base		ZNT-25H	wood top			
H25			36 dia – 36D		\$1199	1498
			42 dia – 42D		\$1255	1569
round	square		48 dia – 48D		\$1272	1590
			36 x 36 – 3636		\$1204	1506
36 DIA	36 x 36		42 x 42 – 4242		\$1263	1576
	rectangle		48 x 48 – 4848		\$1277	1598
42 DIA	42 x 42		30 x 60 – 3060		\$1235	1544
48 DIA	48 x 48					
			laminite top			
			36 dia – 36D		\$1019	1273
			42 dia – 42D		\$1066	1335
			48 dia – 48D		\$1080	1350
			36 x 36 – 3636		\$1024	1279
			42 x 42 – 4242		\$1071	1340
			48 x 48 – 4848		\$1086	1355
			30 x 60 – 3060		\$1050	1312

to specify: please refer to pages 3-4 for complete specifying information. Specify all products by their product code.

pricing effective: July 15, 2021 4:57 PM