

LELAND

Fixed Table

Specifications & Finishes



January 2024

Fixed

Table

LELAND

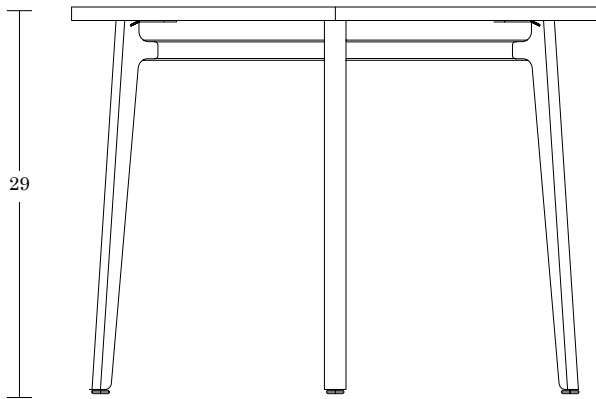



Fixed Table / FXT

SPECIFICATIONS

Top Surface Options [View here](#)

High Pressure Laminate
Forbo
Solid Surface

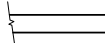
Edge Options [View here](#)

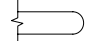
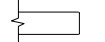
- Vinyl Edge 
- Wood Edge 
- Bullnose Edge 
- Square Edge 

Base Finish Options [View here](#)

Black, White, or Grey textured powder coats

Glide Options

Standard (Black nylon adjustable leveling)

Additional Options

Power / Data
Storage Caddy (Available in Standard Powdercoats)

Top Size Options

Circle	Square	Rectangle	
42 Dia	42 x 42	30 x 60	42 x 84
48 Dia	48 x 48	30 x 72	42 x 120
54 Dia	54 x 54	36 x 96	
60 Dia	60 x 60	36 x 120	

Counter Table

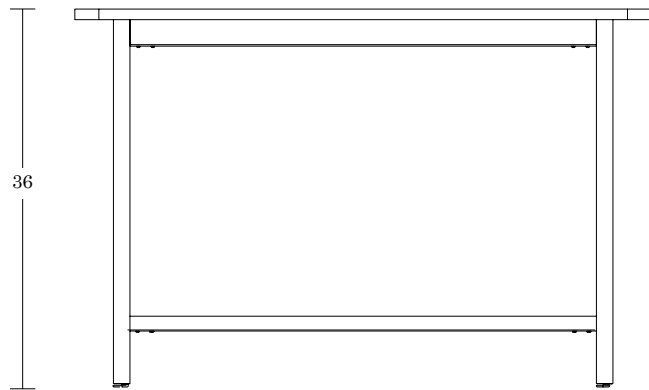

Fixed Counter 30x60 / FXT-3060-36

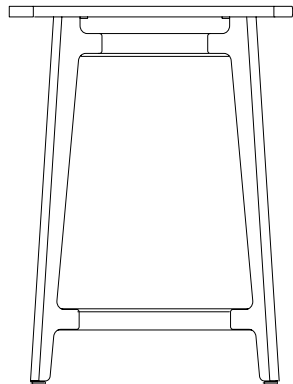





SPECIFICATIONS

Top Surface Options [View here](#)

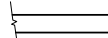
High Pressure Laminate
Forbo
Solid Surface

Edge Options [View here](#)

Vinyl Edge 
Wood Edge 
Bullnose Edge 
Square Edge 

Base Finish Options [View here](#)

Black, White, or Grey textured powder coats

Glide Options

Standard (Black nylon adjustable leveling)

Additional Options

Power / Data
Storage Caddy (Rectangle Tables Only)

Top Size Options



Rectangle

30 x 60 36 x 96
30 x 72 36 x 120
30 x 84 42 x 84
36 x 72 42 x 96
36 x 84 42 x 120

Fixed

Bar Table

LELAND

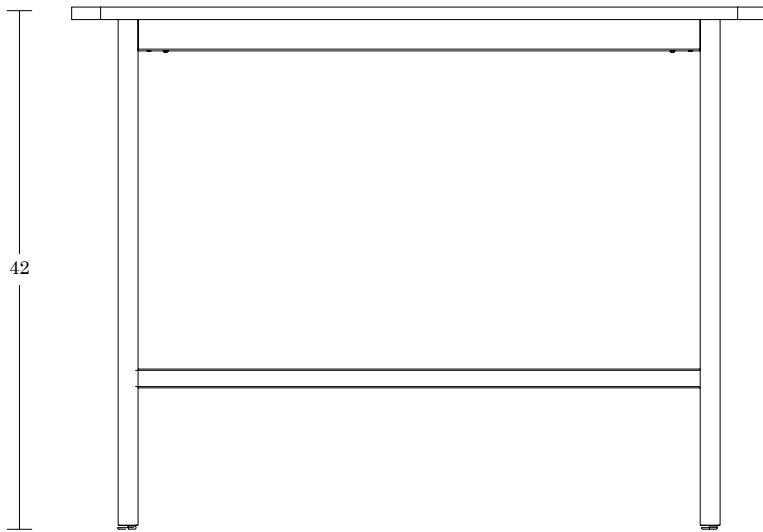

Fixed Bar Table 30x60 / FXT-3060-42

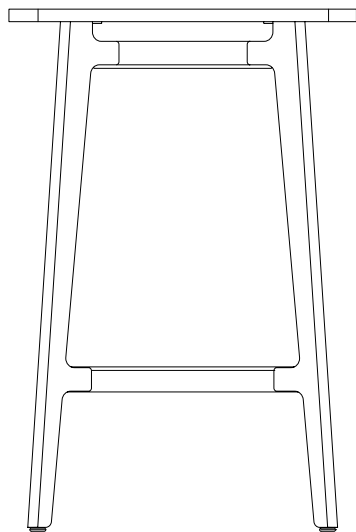





SPECIFICATIONS

Top Surface Options [View here](#)

High Pressure Laminate
Forbo
Solid Surface

Edge Options [View here](#)

- Vinyl Edge 
- Wood Edge 
- Bullnose Edge 
- Square Edge 

Base Finish Options [View here](#)

Black, White, or Grey textured powder coats

Glide Options

Standard (Black nylon adjustable leveling)

Additional Options

Power / Data
Storage Caddy (Rectangle Tables Only)

Top Size Options



Rectangle

- 30 x 60 36 x 96
- 30 x 72 36 x 120
- 30 x 84 42 x 84
- 36 x 72 42 x 96
- 36 x 84 42 x 120

Fixed

Table Top

LELAND



Due to limitations of the color printing process these finish samples should be considered representative only. For larger finish samples, please contact Leland Customer Experience at (800) 859-7510.

[Quick Links /](#)

[View Fixed Table](#)

[View Fixed Counter Table](#)

[View Fixed Bar Table](#)

Customer Experience 800.859.7510 lelandfurniture.com

HIGH PRESSURE LAMINATE



Black Pionite
(SE101)

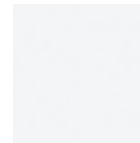

Designer White
Wilsonart
(D354-60)



Platinum Wilsonart
(D315-60)

[Quick Links /](#)[Order Pionite](#)
[Quick Links /](#)[Order Wilsonart](#)

SOLID SURFACE

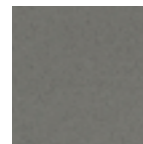

Luna Steel
Formica*
(FR415)

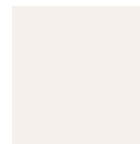

Frost
Formica*
(FR103)

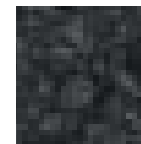

Black Lava
Terrazzo
Formica*
(FR501)



Grafite Terrazzo
Formica*
(FR411)



Dalmata Terrazzo
Formica*
(FR412)



Frosted Gray
Terrazzo
Formica*
(FR622)

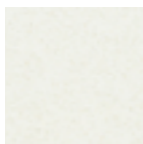

White Renew
Terrazzo
Formica*
(FR748)



Gray Renew
Terrazzo
Formica*
(FR749)

[Quick Links /](#)[Formica](#)

FORBO



Smokey Blue
(4179)

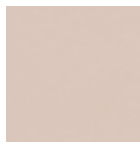

Powder
(4185)



Pebble
(4175)



Olive
(4184)



Maue
(4172)

[Quick Links /](#)[Order Forbo](#)
January 2024



TABLE EDGE DETAIL

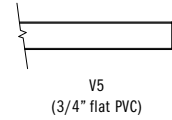

V5
(3/4" flat PVC)
PVC Edge Available with Laminate Table Tops



White
(W)

Grey
(G)

Black
(B)

Saddle
(SL)



Truffle
(TF)

Stone
(SN)

Pewter
(PW)

Amazon
(AMZ)

Bluestone
(BST)

Nubian Brown
(NBR)

Taupe
(TPE)



Indian Smoke
(ISM)

TABLE EDGE DETAIL



(1" flat plywood)

Plywood Edge Available with Laminate and Forbo Table Tops

WOOD FINISH OPTION



Natural
(11M)

TABLE EDGE DETAIL

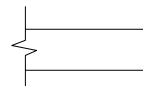

1" Square Edge available with CB, CW, and CG

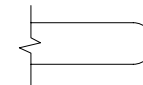

1" Bullnose Edge available with Terrazzo

[View Solid Surface](#)

Quick Links /

[View Fixed Table](#)

[View Fixed Counter Table](#)

[View Fixed Bar Table](#)

For SCS certified wood finishes, please refer to the following document:

[SCS Certified Wood Finishes](#)

Due to limitations of the color printing process these finish samples should be considered representative only. For larger finish samples, please contact Leland Customer Experience at (800) 859-7510.

Customer Experience 800.859.7510 lelandfurniture.com

Fixed

Powder Coat

LELAND



Black Textured
(BT)



Dolphin Textured
(DLT)



White Textured
(WT)

Quick Links /

[View Fixed Table](#)

[View Fixed Counter Table](#)

[View Fixed Bar Table](#)

Due to limitations of the color printing process these finish samples should be considered representative only. For larger finish samples, please contact Leland Customer Experience at (800) 859-7510.

Fixed

Power Options

LELAND



Wire management detail; 10ft long cord



Single Simplex Unit (centered)
(PWR)



Dual USB Unit (centered)
(USB)

*no braided cord option available for single USB



Power Kit
(KIT)

*(2) Single Simplex & (1) Dual USB (only available on rectangular tables)

Quick Links /

[View Fixed Table](#)

[View Fixed Counter Table](#)

[View Fixed Bar Table](#)

Fixed

Power Finishes

LELAND



Wire management detail

Quick Links /

[View Fixed Table](#)

[View Fixed Counter Table](#)

[View Fixed Bar Table](#)



PWR
Black



PWR
Storm



PWR
White



USB
Black



USB
Storm



USB
White



Braided Cord for black
Power unit or Power Kit



Braided Cord for storm
Power unit or Power Kit



Braided Cord for white
Power unit or Power Kit

LELAND

5695 Eagle Drive, SE
Grand Rapids,
Michigan 49512
616-975-9260
lelandfurniture.com