LELAND

NCPA / OMNIA Price List 2024



Pricing Effective: August 2024

January 2024 Pricelist

Terms & Conditions: Table of Contents	2
Ordering Information	4
Terms, Conditions & General Information	6
Freight Program	9

Amadeus Pricelist	AM
Baraga Pricelist	BA
Brit Bench Pricelist	BBM
Bimini Pricelist	BI
Beach Stone Pricelist	BS
Cambre Table Pricelist	CA
Café Parfait Pricelist	CP
Ease Pricelist	ES
Ebb Fully Upholstered Bench Pricelist	EB
Fast Table Pricelist	FT
Fixed Table Pricelist	FXT
Fly Table Pricelist	FLY
Gemma	GM
Gemma Occasional Tabl	GO
Gemma Stitch	GS
Gemma Table	GT
Hammok Pricelist	HS
Handy Stool Pricelist	HA

Leah Table Pricelist	LT
M2 Seating Pricelist	M2S
M3 Table Pricelist	M3T
Marquette Pricelist	MQ
Mass Chair Pricelist	MA
Omena Pricelist	OM
Parfait II Pricelist	PII
Pluto Bench Pricelist	PB
Quarry Pricelist	QR
Rapson Forty-Eight Chair Pricelist	RP48-C
Rapson Thirty-Nine Bench Pricelist	RP39-B
Rapson Thirty-Nine Guest Pricelist	RP39-G
Rapson Thirty-Nine Lounge Pricelist	RP39-L
Slam Pricelist	SL
Slam Beam Pricelist	SB
Valeri Pricelist	VS

Orders

All orders must be submitted in writing either by fax or e-mail. Specify each item by its product code and the corresponding model description, finish, upholstery and options offered in the price list. If the customer's current product order must match a previous order, Leland International must be notified. A sample product from the original order must be submitted at the expense of the customer to assure uniformity of finish and construction. Orders with missing or incorrect information such as model, finish, color, pricing, etc. will be scheduled upon receipt of correct and complete information.

Leland products are specified for and installed in a variety of end user applications. It is the responsibility of the purchasing party to understand the end user's intent and purchase products appropriate for that application. Leland takes no responsibility for incorrect specifications. Acceptance and fulfillment of any purchase order does not imply that the product is suitable for a certain application. Leland will only warranty products that have been installed in applications for which they were designed.

If multiple delivery schedules are required, the customer must submit separate purchase orders for each delivery date.

Acknowledgement

Orders are only accepted by issuance of our formal acknowledgment. It is the purchaser's responsibility to check acknowledgements and invoices for accuracy. If there is any discrepancy, the customer must notify Leland International within 72 hours. Failure to notify Leland International within this time period will constitute acceptance of the order as acknowledged, and our acknowledgment is final and binding.

All acknowledgments will contain an estimated ship date. If for some reason the furniture must not ship earlier than the estimated ship date, please specify a "Do not ship before date" in your purchase order. We are not responsible for delays in scheduling or failure to make scheduled ship date due to strikes, lockouts or other labor complications, war, riots, Acts of God, fires, accidents, restraints affecting shipment or credit, reduced supply or excessive cost of fuel or raw material, delays from suppliers, compliance with government regulations or other unforeseen contingencies.

Wood Finishes

Wood finishes can be light sensitive; therefore, care should

be taken to avoid placing chairs in areas exposed to intense natural light. Due to variations common to all wood species,

the color and grain characteristics of the finish samples may not exactly match that of the finished product. Custom finishes must meet factory approval and are subject to a \$100.00 minimum net mixing charge. Please allow up to three weeks to prepare the custom wood finish match sample. Orders will not be scheduled or acknowledged until finish match approval is received in writing.

Due to limitations of the raw materials and the natural background color of wood, not all colors can be successfully reproduced. The suitability of a color for custom finish matching cannot always be determined beforehand. This is especially true in the case of custom colors submitted on non-wood products. If we are unable to produce a commercial match to your custom color, you will be notified at the earliest possible date, and no charge will be levied.

Laminates

The following laminates with the manufacturers noted are considered to be standard and are usually in stock.

FORMICA®

www.formica.com/en/us/trade-products or call 800.367.6422

Select solid colors, wood grains or patterns
Select number/name
Select standard finishes
Laminates with -58 (matte finish) are standard

WILSONART®

www.wilsonartcontract.com/pattern-availability/
or call 800.433.3222

Select laminate finish,
Select Leland standard finish -38 (fine velvet texture)
or -60 (matte)

PIONITE®

www.pionite.com/pionite/pages_pionite/pionite_colors.html
or call 800.746.6483

Select colors

Customer's Own Information (COM)

Leland International reserves the right of preliminary approval of all COM, prior to order acceptance. Even after such preliminary approval, Leland International reserves the right to reject COM if, upon physical inspection of the COM, it proves unacceptable for use on Leland International products. When this occurs, the customer will be notified in writing with an explanation of the problem. A written release from the customer will be required for the order to be processed.

It is recommended that all COM textile be tested for compatibility with Leland's products prior to sending COM to Leland for application. Please contact Customer Experience to request the COM Approval Form with instructions for COM submittal.

Choosing not to have COM textile tested for compatibility may result in the COM being rejected at the expense of the customer.

Leland International cannot assume responsibility for durability, appearance or other qualities of customer's own material on the finished product and does not give any warranty with respect to COM. At Leland International's discretion,

additional yardage, labor charges, or handling surcharges may be required as a condition of COM acceptance. COM delivered to Leland International without proper identification may be refused, and Leland International shall have no responsibility for loss or any other claims. Excess textile will not be returned unless specifically requested in writing.

Please contact the Leland Customer Experience Department for yardage requirements on all COM textiles which are patterned or narrower than 54 inches wide.

Orders using COM may be rescheduled if the COM has not been received two (2) weeks prior to the original ship date. Every effort will be made to avoid a delay and to complete the customer's order within the standard lead time.

All shipments of COM to Leland International must be sent prepaid. COM should be sent to:

LELAND INTERNATIONAL
5695 Eagle Drive SE
Grand Rapids, Michigan 49512

COM packages must include the following information:

- Name of customer

- Purchase order number to which the material is to be applied and Leland Sales Order, if known.

Purchase orders specifying COM must include the following:

- Indicate which side of the textile is to be exposed (manufacturer's implied face will be used if no side is indicated by the customer).
- If textile is a stripe or pattern, specify vertical or horizontal upholstered application (textile will be applied off the bolt if no direction is indicated by the customer).
- COM suppliers' name, textile number and quantities of pieces to which the material is to be applied.

California Technical Bulletin 133 [TB 133]

TB 133 is a full scale fire performance test of complete articles of seating furniture. Some Leland International products in combination with a variety of upholstery textiles have been tested and are in compliance with TB 133. Test documentation is available upon request. If you wish to specify Leland products that have not been tested for compliance with TB 133 please consult Leland Customer Experience Department for TB 133 testing cost information.

In order for Leland products to comply with TB 133 the foam must be protected with a fire blocker or a special fire retardant foam must be used. For those products that must comply with TB 133 there will be a net charge per chair for fire blocker laminating or fire retardant foam. Please contact Leland International for a CAL 133 quotation on all seating.

Since TB 133 tests furniture and not components, there are no TB 133 approved textiles. Textiles comprised solely or in any combination of the following fibers are more likely to be suitable components for chairs that must comply with TB 133.

Acrylic	Nylon	
Vinyl	Animal Hairs	Polyester
Wool		Virgin
Cordura	Rayon	
Viscose	Cotton	
SEF Modacrylic	Wool	
Leather	Silk	
Worsted Wool	Modacrylic	
Spun Nylon	Mohair	
Trevira		

Prices

All prices are list prices F.O.B. our factory in Grand Rapids, Michigan 49512. Our pricing includes packing and corrugated cartoning for common carrier shipments. List prices do not include freight, storage, taxes or additional packaging required for certain carriers and are subject to change without notice.

We reserve the right to change quotation prices prior to acceptance by the buyer. Quotation prices must be accepted within 30 days unless otherwise specified in writing on the quotation. Pricing on orders specifying shipment 90 days or more after the formal date of acknowledgment will be based on pricing prevailing at time of shipment.

Resale Rights

Leland International reserves the right to reject any order placed by any customer for any reason, irrespective of whether orders have been previously accepted from such customer, without incurring liability to such customer. No customer shall have a continuing right to buy products from the company except pursuant to a formal dealer agreement or other written agreement covering future supply executed by the company and the reseller. Distribution of the price list or catalog does not itself constitute an offer to sell.

Credit and Payment Terms

An open account may be established for new customers. One bank and three trade references will be required and must be faxed to Leland International, attention:

Accounting. Credit will be established upon review and approval of your application.

Allow up to four weeks delay for credit approval. To avoid this delay, orders on new accounts must be accompanied by a 50% deposit. If credit is approved by the time the order is ready for shipment, the balance must be paid within terms. Accounts that are inactive for a twelve month period will automatically be closed and are subject to the above conditions for new accounts. Leland International may change or cancel credit at its discretion and may request advance payment at any time.

Upon establishment of an open account, terms are "Net 15 Days" after date of invoice with a credit limit established on a per customer basis. 1½% per month service charge will be added to all past due accounts. Orders will not be processed for past due accounts until the amount due, including any

service charge, is paid in full. All custom orders will require a down payment of 50% and will not be scheduled for production until the down payment is received.

Leland International reserves the right to revoke the terms of any customer at any time for any reason.

Orders for customers that have pre-paid terms require payment in full in (7) seven business days prior to the scheduled ship date. Payment not received by this day may result in the order being rescheduled.

Changes and Cancellations

Orders are not subject to change or cancellation without factory approval. Leland International will make every reasonable effort to stop production scheduling, shipment, etc., upon receipt of written notification of changes, cancellations or deferments stipulated as follows. Approved cancellations, changes, and delivery date extensions may be subject to charges.

Cancellations

Cancellations received prior to production will be assessed a \$100 net cancellation charge. Cancellations received after production has been started will be assessed the total accumulated cost of the project plus a \$100 net cancellation charge.

Deferred Shipments

If the order is complete or in the production cycle, charges will be assessed from the completion date in accordance with policy for "Storage by the Manufacturer."

Storage by the Manufacturer

If the customer cannot accept delivery when merchandise is ready, according to the terms of our acknowledgment, we reserve the right to transfer goods to storage at the customer's expense, and the order will be invoiced at the time of storage. Payment of this invoice will be due on the original terms given to the customer. Storage charges and freight charges for delivery will be invoiced separately upon release of the merchandise from storage and will be due upon receipt of the invoice. Orders put into storage require payment in full and all incurred storage charges must be paid prior to the order being shipped.

Shipping

We will ship in accordance with the customer's written instructions. If customer omits specific shipping instructions, we will ship in the manner that we consider to be the best way. All shipments are sent F.O.B. Grand Rapids, Michigan 49512. Leland International's liability ends when received by the carrier at Leland International's dock. Title of the goods and risk of loss transfers to the buyer at that time. Freight shall be paid by the buyer unless otherwise acknowledged in writing by Leland International. We make every effort to ship orders complete and on schedule. We reserve the right to make partial shipments as merchandise is ready. Failure to deliver all the merchandise at one time does not relieve the customer of the obligation to accept and pay for merchandise received.

Damage Claims

All Leland International products are thoroughly inspected prior to shipment from our factory and packed to comply with carrier requirements. Customers must carefully inspect all items upon arrival and note any damage on the delivery receipt. Phrasing such as "Subject to Inspection" does not constitute a note of damage and will not be accepted as grounds for honoring a freight claim. A written claim must be filed within 15 days of receipt with the carrier if any obvious or subsequent

concealed damage is discovered and still does not guarantee the honoring of freight claim. Caution: When a clear receipt is obtained by a carrier, Leland International, nor the carrier, are any longer responsible for damages or shortages. Processing claims for damage and shortages are the responsibility of the buyer unless otherwise specified in writing by Leland International. At no time can claims be deducted from our invoices.

Delivery Charges

Charges incurred by Leland International complying with any non-standard shipment request such as inside delivery, expediting, redelivery, weekend delivery, unpacking, straight trucks, specific driver requests, or temporary holding will be invoiced to the purchaser.

Storage by Owner

Due to the inherent nature of wood products, we cannot guarantee any product stored or set in place in an environment where temperature and humidity are not controlled. Temperatures must be maintained within a range of 50°-80° F (10°-27° C); the relative humidity must be maintained between 25% and 40%. These conditions are also recommended for human health standards.

Product Discrepancy

Errors in products including color, size, other variations, or missing components must be reported to Leland International within thirty (30) days of delivery. Failure by the purchaser to report any product inaccuracies within thirty (30) days of delivery shall constitute acceptance of the product.

Miscellaneous

All costs for furniture installation, removal from service and reinstallation due to damage claims, partial shipments, shipping errors or warranty claims is the responsibility of the customer. Leland International will not be liable for costs associated with any of the above conditions.

Sizes and weights are considered to be approximate. Leland International reserves the right to make changes in design and construction or discontinue products without notice. Due to conditions beyond our control all wood products, textiles and vinyls are subject to variations in color, texture and grain.

Price list specifications supersede all other specifications whether verbal or written, and may not be altered without the written consent of an officer of Leland International. All clerical errors on any agreement, publication, correspondence, price list, or product literature pieces are subject to correction at any time.

MAINTENANCE

Since chairs and tables are installed and used under a variety of conditions, users must make inspections no less than every six months to look for damage or signs of structural fatigue incurred in daily handling, use and abuse. Examinations must include welds, machine screw assemblies and the shell to base fasteners. If problems are discovered that could compromise the structural safety of a chair, it should be immediately removed from service and Leland International should be notified. Coats and other articles should not be hung on the back of chairs. This practice may cause chairs to be unstable. Chairs are not designed to be placed seat down on table surfaces. Chairs stored in this manner are unstable. The shock of chairs falling from table tops may compromise the structural integrity of the shell/base attachment.

signs of structural fatigue incurred in daily handling, use, or abuse. Inspections must include, but are not limited to, the tightening of bolts and fasteners, and the lubrication of mechanisms. Failure to properly maintain Leland products will void this warranty.

Leland International will not be liable for loss of time, inconvenience, commercial loss, or incidental or consequential damages that may result from a warranty claim.

Warranty

All merchandise is manufactured in accordance with our high industrial and design standards and is warranted to be free from defects of material and workmanship for a period of (5) five years from the date of delivery or placement in storage. This warranty covers goods under normal use and is in service under conditions for which the merchandise is designed. Leland International considers normal use to be (5) five days per week (8) eight hours per day. Extended use (multiple shifts, 24 hour facilities, etc) will reduce this warranty to (2) two years. We offer no warranty on chair upholstery materials, plastic laminate table surfaces and operating components other than those expressed by the manufacturer of those components.

Our obligation during this warranty period is limited to repair or replacement at our option. This warranty becomes null and void on any goods repaired or altered by any person not so authorized by Leland International or any merchandise which has been subject to misuse, improper storage, including placing chairs seat down on tables, negligence, or accident. We make no other warranties either expressed or implied as to any matter whatsoever, including without limitation, the condition of the merchandise, its merchantability, or its fitness for any particular user or purpose.

All claims will be processed by the Customer Experience Department. All returns must be authorized in writing. Merchandise authorized for return and subsequent repair or replacement merchandise shall be removed from service. All shipping, packaging, and installation charges shall be at the expense of the customer. Since furniture is installed and used under a variety of conditions, users are required to make inspections every six months to look for damage or

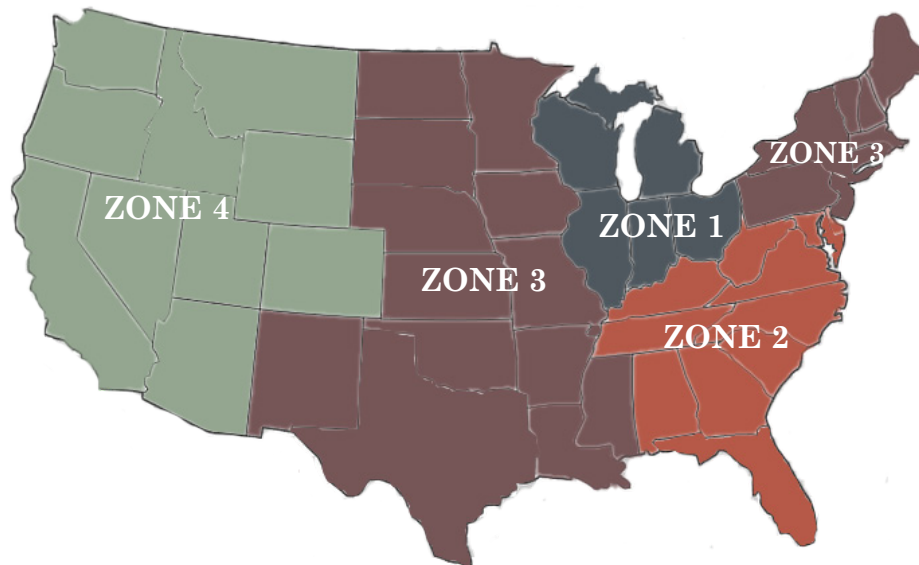

Zone 1 (4%)	Zone 2 (5%)	Zone 3 (6%)	Zone 3 (6%) CONT.	Zone 4 (7%)
Indiana	Alabama	Arkansas	New Hampshire	Arizona
Illinois	Delaware	Connecticut	New Jersey	California
Michigan	Florida	Iowa	New Mexico	Colorado
Ohio	Georgia	Kansas	New York	Idaho
Wisconsin	Kentucky	Louisiana	North Dakota	Montana
	Maryland	Maine	Oklahoma	Nevada
	North Carolina	Massachusetts	Pennsylvania	Oregon
	South Carolina	Minnesota	Rhode Island	Utah
	Tennessee	Mississippi	South Dakota	Washington
	Virginia	Missouri	Texas	Wyoming
	Washington DC	Nebraska	Vermont	
	West Virginia			

Overview

Leland Furniture's Freight Program is offered to all customers for convenient and competitive freight prices in the continental United States.

How It Works

1. Determine the LIST value of your order.
2. Determine the zone to which the freight will be shipping (Zones 1-4)
3. Calculate your freight charges by multiplying the list price and applicable zone charges (e.g.: \$10,000 LIST order shipping to Arizona is $\$10,000 \times 0.07 = \700 NET freight).
4. Verify that your calculated charges meet or exceed minimums.
5. Note on your PO "Freight determined by Leland Freight Program".

Zone Percentages and Minimums

Zone 1	4%	Minimum \$350
Zone 2	5%	Minimum \$350
Zone 3	6%	Minimum \$350
Zone 4	7%	Minimum \$350

Remember

Freight percentages are based on LIST price of order.

Leland Furniture Freight Program is based on dockside delivery only. Residential Delivery, Inside Delivery, etc. will incur additional charges; please contact Leland Customer Service for current prices.

Freight is FOB Grand Rapids, MI 49512; the receiving company is responsible for noting any damage at the time of delivery on the Delivery Receipt. Leland Furniture assumes no responsibility for freight damage, either noted on delivery receipt or concealed.

As fuel prices fluctuate, Leland Furniture reserves the right to add necessary fuel surcharges.

Leland Furniture reserves the right to change or discontinue the Freight Program at any time.

Amadeus

January 2024 Price List



Amadeus

Table of Contents	AM2
Specification Information	AM3
Specification Example	AM4
Stacking/ganging sled base	AM5
Stacking Chair Tapered Four Leg Base	AM7
Arm Chair, Tapered Four Leg Base	AM9
Side Chair, Wood Base	AM11
Counter Chair, Sled base	AM13
Counter Chair, Wood Base	AM15
Bar Chair, Sled base	AM17
Bar Chair, Wood Base	AM19

Chair Model

DESCRIPTION	CODE
AMADEUS stacking/ganging sled base	AMS
AMADEUS stacking chair, tapered four leg base	AM4
AMADEUS arm chair, tapered four leg base	AMA
AMADEUS side chair, wood base	AMSW
AMADEUS counter chair	AMCS
AMADEUS counter chair, wood base	AMCW
AMADEUS bar chair	AMBS
AMADEUS bar chair, wood base	AMBW

Shell Selection

DESCRIPTION	CODE
Polypropylene	PO
Polypropylene with Upholstered Seat Onlay	PU
Fully Upholstered	FU
3D Beech Veneer	3DB
3D Beech Veneer with Upholstered Seat Onlay	3BU
3D American Walnut Veneer	3DW
3D American Walnut Veneer with Upholstered Seat Onlay	3WU

Shell Finish/Color

POLYPROPYLENE SHELL:

DESCRIPTION	CODE	DESCRIPTION	CODE
White	WT	Oxford	OX
Black	BK	Dolphin	DL
Fawn	FW	Seafoam	SF
Fog	FG	Habanero	HB
Blue Sky	BS	Dijon	DJ
Ink	IN		

CUSTOM POLYPROPYLENE COLORS

Custom color match is available upon request.
Please contact hello@lelandfurniture.com for further information

BEECH 3D VENEER SHELL:

DESCRIPTION	CODE
Natural Beech	09

STANDARD LELAND COLORS

AMERICAN WALNUT 3D VENEER SHELL:

DESCRIPTION	CODE
Natural Walnut Matte	08M

Fully Upholstered or Onlay Selection

Please refer to Leland Textile Program which features textiles and leathers from the following partners:

- Camira
- Carnegie
- CF Stinson
- Green Hides
- Maharam
- Unika Vaev

The complete grade list can be found on our website or you can specify COM/COL. Due to the design of this product, it is recommended that all non pre-approved textile be tested for compatibility.

Frame Finishes

SLED BASE & TAPERED FOUR LEG BASE:

DESCRIPTION	CODE
Sterling	ST
Warm Grey	WG
Cool Grey	CG
Black	B
White	W
Habanero	HBN
Matte Seafoam	MSF
Matte Dijon	MDJ
Matte Mercury	MMR
Matte Mineral	MMN
Matte Burnish	MBN
Matte Foundry	MFN
Chrome	C

TEXTURED

DESCRIPTION	CODE
White Textured Powder coat	WT
Black Textured Powder coat	BT
Dolphin Textured Powder coat	DLT
Ink Textured Powder Coat	INT

Glide or Caster Type

STANDARD GLIDES:

DESCRIPTION	CODE
Poly (Sled base)	S
Nylon (Tapered Four leg Base) & Wood Base	S

OPTIONAL GLIDES:

DESCRIPTION	CODE
Felt	FC

*Please note that optional glides for four leg models raise the chair height .5 inch.

Stacking note

Amadeus side chair, armless models stack as follows: (including upholstered)

SLED BASE:

ARMLESS:
Floor: 15 High
Dolly: 20 High

TAPERED FOUR LEG BASE:

ARMLESS:
Floor: 10 High
Dolly: 12 High

Specifications required to create the product code

- Model
- Shell Selection
- Shell Finish/Color
- Upholstered Onlay Selection (when applicable)
- Frame Finish (or foot ring where applicable)
- Glide Type

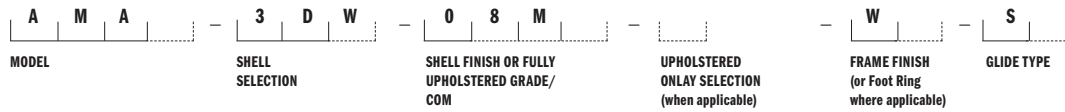

MODEL

Amadeus arm chair, Tapered four leg base (AMA)

SHELL SELECTION

3D American Walnut Veneer (3DW)

SHELL FINISH/COLOR

Natural Walnut Matte (08M)

UPHOLSTERED ONLAY SELECTION

When applicable, enter upholstery grade, COM

FRAME FINISH (OR FOOT RING WHERE APPLICABLE)

White (W)

GLIDE TYPE

Standard Nylon (S)



AMADEUS STACKING/GANGING SLED BASE
Design: Martin Ballendat

AM5



Amadeus Sled Base Chair	MODEL	FRAME FINISH	LIST PRICE
Polypropylene shell	AMS-PO	Powder Coat	\$400
W 21 D 21.75 H 31.75 SH 18		Chrome	\$463

Optional Glides: Add \$8.00 net per chair for a set of four (4).



Amadeus Sled Base Chair	MODEL	LIST PRICE/GRADE	COM/COL	A	B	C	D	E	F	G	H	I	J	K	L
Polypropylene shell upholstered seat onlay	AMS-PU	Powder Coat	\$538	582	603	625	647	668	691	712	734	755	778	799	821
		Chrome	\$600	644	665	687	709	731	752	774	796	817	840	861	883

W 21 D 21.75 H 32 SH 19

COM Yardage: 1 or 2 seats: .75 yard
Contact Leland Customer Experience for yardage requirements on textiles with repeats.
Optional Glides: Add \$8.00 net per chair for a set of four (4).



Amadeus Sled Base Chair	MODEL	LIST PRICE/GRADE	COM/COL	A	B	C	D	E	F	G	H	I	J	K	L
Fully upholstered	AMS-FU	Powder Coat	\$725	821	870	920	968	1019	1068	1117	1166	1216	1265	1315	1364
		Chrome	\$793	891	940	989	1038	1088	1138	1187	1236	1285	1336	1385	1433

W 21 D 21.75 H 32 SH 18

COM Yardage: 1 seat: 1.5 yards
Contact Leland Customer Experience for yardage requirements on textiles with repeats.
Optional Glides: Add \$8.00 net per chair for a set of four (4).

To specify:
Please refer to pages 3-4 for complete specifying information.
Specify all products by their product code.

Pricing Effective: January 2024

AMADEUS STACKING/GANGING SLED BASE
Design: Martin Ballendat

AM6



Amadeus Sled Base Chair	MODEL	FRAME FINISH	LIST PRICE
3D Beech veneer shell	AMS-3DB	Powder Coat	\$771
W 21 D 21.75 H 31.75 SH 18		Chrome	\$839

Optional Glides: Add \$8.00 net per chair for a set of four (4).



Amadeus Sled Base Chair	MODEL	LIST PRICE/GRADE	COM/COL	A	B	C	D	E	F	G	H	I	J	K	L
3D Beech veneer shell, upholstered seat onlay	AMS-3BU	Powder Coat	\$918	965	988	1012	1035	1058	1083	1107	1129	1154	1176	1199	1223
		Chrome	\$985	1033	1056	1079	1103	1127	1149	1174	1197	1220	1244	1267	1290

W 21 D 21.75 H 32 SH 19

COM Yardage: 1 or 2 seats: .75 yard
Contact Leland Customer Experience for yardage requirements on textiles with repeats.
Optional Glides: Add \$8.00 net per chair for a set of four (4).



Amadeus Sled Base Chair	MODEL	FRAME FINISH	LIST PRICE
3D Walnut veneer shell	AMS-3DW	Powder Coat	\$1114
W 21 D 21.75 H 31.75 SH 18		Chrome	\$1180

Optional Glides: Add \$8.00 net per chair for a set of four (4)..



Amadeus Sled Base Chair	MODEL	LIST PRICE/GRADE	COM/COL	A	B	C	D	E	F	G	H	I	J	K	L
3D Walnut veneer shell, upholstered seat onlay	AMS-3WU	Powder Coat	\$1262	1308	1334	1356	1380	1403	1427	1449	1474	1496	1520	1544	1567
		Chrome	\$1328	1374	1399	1423	1446	1469	1493	1516	1539	1563	1587	1610	1635

W 21 D 21.75 H 32 SH 19

COM Yardage: 1 or 2 seats: .75 yard
Contact Leland Customer Experience for yardage requirements on textiles with repeats.
Optional Glides: Add \$8.00 net per chair for a set of four (4).

To specify:
Please refer to pages 3-4 for complete specifying information.
Specify all products by their product code.



**Amadeus
Tapered Four Leg Base Chair**

	MODEL	FRAME FINISH	LIST PRICE
Polypropylene shell	AM4-PO	Powder Coat	\$475
W 21 D 22 H 32 SH 18		Chrome	\$541

Optional Glides: Add \$8.00 net per chair for a set of four (4).



**Amadeus
Tapered Four Leg Base Chair**

	MODEL	LIST PRICE/GRADE	COM/COL	A	B	C	D	E	F	G	H	I	J	K	L
Polypropylene shell, upholstered seat onlay	AM4-PU	Powder Coat	\$617	663	684	707	730	751	774	797	819	841	864	886	909
		Chrome	\$682	727	749	772	794	817	839	862	884	907	929	952	974

W 21.5 D 22 H 32 SH 19

COM Yardage: 1 or 2 seats: .75 yard
Contact Leland Customer Experience for yardage requirements on textiles with repeats.
Optional Glides: Add \$8.00 net per chair for a set of four (4).



**Amadeus
Tapered Four Leg Base Chair**

	MODEL	LIST PRICE/GRADE	COM/COL	A	B	C	D	E	F	G	H	I	J	K	L
Fully upholstered	AM4-FU	Powder Coat	\$816	916	968	1018	1069	1120	1172	1221	1273	1323	1376	1425	1475
		Chrome	\$888	991	1042	1091	1144	1193	1245	1294	1346	1397	1448	1497	1549

W 21.5 D 22 H 32 SH 18

COM Yardage: 1 seat: 1.5 yards
Contact Leland Customer Experience for yardage requirements on textiles with repeats.
Optional Glides: Add \$8.00 net per chair for a set of four (4).

To specify:
Please refer to pages 3-4 for complete specifying information.
Specify all products by their product code.



**Amadeus
Tapered Four Leg Base Chair**

	MODEL	FRAME FINISH	LIST PRICE
3D Beech veneer shell	AM4-3DB	Powder Coat	\$864
W 21.5 D 22 H 32 SH 18		Chrome	\$932

Optional Glides: Add \$8.00 net per chair for a set of four (4).



**Amadeus
Tapered Four Leg Base Chair**

	MODEL	LIST PRICE/GRADE	COM/COL	A	B	C	D	E	F	G	H	I	J	K	L
3D Beech veneer shell, upholstered seat onlay	AM4-3BU	Powder Coat	\$1014	1063	1086	1111	1135	1160	1183	1209	1231	1256	1281	1304	1328
		Chrome	\$1083	1130	1156	1180	1205	1228	1252	1276	1300	1324	1348	1375	1397

W 21.5 D 22 H 32 SH 19

COM Yardage: 1 or 2 seats: .75 yard
Contact Leland Customer Experience for yardage requirements on textiles with repeats.
Optional Glides: Add \$8.00 net per chair for a set of four (4).



**Amadeus
Tapered Four Leg Base Chair**

	MODEL	FRAME FINISH	LIST PRICE
3D Walnut veneer shell	AM4-3DW	Powder Coat	\$1216
W 21.5 D 22 H 32 SH 18		Chrome	\$1288

Optional Glides: Add \$8.00 net per chair for a set of four (4).



**Amadeus
Tapered Four Leg Base Chair**

	MODEL	LIST PRICE/ GRADE	COM/COL	A	B	C	D	E	F	G	H	I	J	K	L
3D Walnut veneer shell upholstered seat onlay	AM4-3WU	Powder Coat	\$1368	1416	1441	1466	1490	1514	1538	1562	1586	1610	1635	1659	1685
		Chrome	\$1439	1488	1510	1535	1560	1584	1607	1632	1657	1679	1705	1728	1753

W 21.5 D 22 H 32 SH 19

COM Yardage: 1 or 2 seats: .75 yard
Contact Leland Customer Experience for yardage requirements on textiles with repeats.
Optional Glides: Add \$8.00 net per chair for a set of four (4).

**To specify:
Please refer to pages 3-4 for
complete specifying information.
Specify all products by their
product code.**

AMADEUS ARM CHAIR, TAPERED FOUR LEG BASE
Design: Martin Ballendat

AM9



**Amadeus Arm Chair
Tapered Four Leg Base Chair**

	MODEL	FRAME FINISH	LIST PRICE
Polypropylene shell	AMA-PO	Powder Coat	\$592
W 23.5 D 21.75 H 32 SH 18 AH 26		Chrome	\$704

Optional Glides: Add \$8.00 net per chair for a set of four (4).



**Amadeus Arm Chair
Tapered Four Leg Base Chair**

	MODEL	LIST PRICE/GRADE	COM/COL	A	B	C	D	E	F	G	H	I	J	K	L
Polypropylene shell, upholstered seat onlay	AMA-PU	Powder Coat	\$754	806	832	860	885	910	937	961	987	1014	1039	1064	1089
		Chrome	\$845	897	923	948	976	1001	1026	1052	1079	1104	1129	1155	1181

W 23.75 D 22 H 32
SH 19 AH 26

COM Yardage: 1 or 2 seats: .75 yard
Contact Leland Customer Experience for yardage requirements on textiles with repeats.
Optional Glides: Add \$8.00 net per chair for a set of four (4).



**Amadeus
Tapered Four Leg Base Chair**

	MODEL	LIST PRICE/GRADE	COM/COL	A	B	C	D	E	F	G	H	I	J	K	L
Fully upholstered	AMA-FU	Powder Coat	\$981	1096	1154	1213	1272	1327	1386	1445	1502	1560	1616	1673	1732
		Chrome	\$1082	1196	1255	1314	1370	1429	1487	1544	1602	1661	1719	1777	1833

W 23.5 D 21.75 H 32
SH 18 H 26

COM Yardage: 1 seat: 1.5 yards
Contact Leland Customer Experience for yardage requirements on textiles with repeats.
Optional Glides: Add \$8.00 net per chair for a set of four (4).

To specify:
Please refer to pages 3-4 for complete specifying information.
Specify all products by their product code.

Pricing Effective: January 2024

AMADEUS ARM CHAIR, TAPERED FOUR LEG BASE

Design: Martin Ballendat

AM10



Amadeus Arm Chair Tapered Four Leg Base

	MODEL	FRAME FINISH	LIST PRICE
3D Beech veneer shell	AMA-3DB	Powder Coat	\$1073
W 23.75 D 22 H 32 SH 19 AH 26		Chrome	\$1191

Optional Glides: Add \$8.00 net per chair for a set of four (4).



Amadeus Arm Chair Tapered Four Leg Base Chair

	MODEL	LIST PRICE/ GRADE	COM/COL	A	B	C	D	E	F	G	H	I	J	K	L
3D Beech veneer shell, upholstered seat onlay	AMA-3BU	Powder Coat	\$1245	1300	1326	1356	1383	1410	1437	1465	1492	1519	1549	1574	1602
		Chrome	\$1327	1384	1412	1439	1467	1494	1523	1550	1576	1604	1631	1660	1686

W 23.75 D 22 H 32
SH 19 AH 26

COM Yardage: 1 or 2 seats: .75 yard
Contact Leland Customer Experience for yardage requirements on textiles with repeats.
Optional Glides: Add \$8.00 net per chair for a set of four (4).



Amadeus Arm Chair Tapered Four Leg Base

	MODEL	FRAME FINISH	LIST PRICE
3D Walnut veneer shell	AMA-3DW	Powder Coat	\$1516
W 23.5 D 21.75 H 32 SH 18 AH 26		Chrome	\$1636

Optional Glides: Add \$8.00 net per chair for a set of four (4).



Amadeus Arm Chair Tapered Four Leg Base

	MODEL	LIST PRICE/ GRADE	COM/COL	A	B	C	D	E	F	G	H	I	J	K	L
3D Walnut veneer shell, upholstered seat onlay	AMA-3WU	Powder Coat	\$1690	1744	1773	1800	1827	1854	1883	1909	1938	1966	1993	2019	2049
		Chrome	\$1804	1861	1886	1913	1943	1969	1997	2025	2053	2079	2108	2135	2162

W 23.5 D 22 H 32
SH 19 H 26

COM Yardage: 1 or 2 seats: .75 yard
Contact Leland Customer Experience for yardage requirements on textiles with repeats.
Optional Glides: Add \$8.00 net per chair for a set of four (4).

To specify:

Please refer to pages 3-4 for complete specifying information. Specify all products by their product code.

Pricing Effective: January 2024

AMADEUS SIDE CHAIR, POLY SHELL, WOOD BASE
 Design: Martin Ballendat

AM11

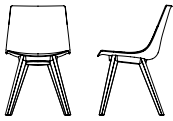

Amadeus Side Chair

Wood Base	MODEL	FRAME FINISH	LIST PRICE
Polypropylene shell	AMSW-PO		\$867
W 19 D 22 H 32 SH 18		Optional Glides: Add \$8.00 net per chair for a set of four (4).	

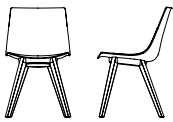

Amadeus Side Chair

Wood Base	MODEL	LIST PRICE/GRADE	COM/COL	A	B	C	D	E	F	G	H	I	J	K	L
Polypropylene shell, upholstered seat onlay	AMSW-PU	\$867		1021	1044	1065	1087	1109	1130	1152	1174	1196	1217	1240	1261
W 19 D 22 H 32 SH 19		COM Yardage: 1 or 2 seats: .75 yard													
		Contact Leland Customer Experience for yardage requirements on textiles with repeats.													
		Optional Glides: Add \$8.00 net per chair for a set of four (4)													

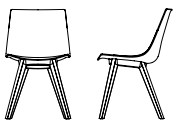

Amadeus Side Chair

Wood Base	MODEL	LIST PRICE/ GRADE	COM/COL	A	B	C	D	E	F	G	H	I	J	K	L
Fully upholstered	AMSW-FU	\$1257		1359	1410	1459	1510	1562	1613	1663	1714	1765	1814	1865	1917
W 19 D 22 H 32.5 SH 18		COM Yardage: 1 seat: 1.5 yards													
		Contact Leland Customer Experience for yardage requirements on textiles with repeats.													
		Optional Glides: Add \$8.00 net per chair for a set of four (4)													

To specify:
 Please refer to pages 3-4 for complete specifying information.
 Specify all products by their product code.

Pricing Effective: January 2024

AMADEUS SIDE CHAIR, WOOD BASE
Design: Martin Ballendat

AM12

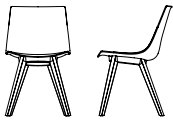

**Amadeus Side Chair
Wood Base**

	MODEL	FRAME FINISH	LIST PRICE
3D beech veneer shell W 19 D 22 H 32 SH 18	AMSW-3DB		\$1734

Optional Glides: Add \$8.00 net per chair for a set of four (4).

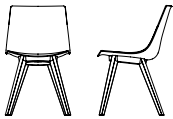

**Amadeus Side Chair
Wood Base**

	MODEL	LIST PRICE/ GRADE	COM/ COL	A	B	C	D	E	F	G	H	I	J	K	L
3D beech veneer shell, upholstered seat onlay W 19 D 22 H 32 SH 18	AMSW-3BU		\$1886	1934	1956	1983	2006	2031	2055	2079	2103	2127	2151	2176	2201

COM Yardage: 1 or 2 seats: .75 yard
Contact Leland Customer Experience for yardage requirements on textiles with repeats.
Optional Glides: Add \$8.00 net per chair for a set of four (4)

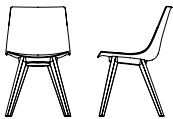

**Amadeus Side Chair
Wood Base**

	MODEL	FRAME FINISH	LIST PRICE
3D american walnut veneer shell W 19 D 22 H 32 SH 18	AMSW-3DW		\$2089

Optional Glides: Add \$8.00 net per chair for a set of four (4).

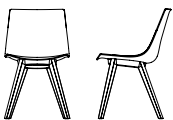

**Amadeus Side Chair
Wood Base**

	MODEL	LIST PRICE/ GRADE	COM/ COL	A	B	C	D	E	F	G	H	I	J	K	L
3D american walnut veneer shell, upholstered seat onlay W 19 D 22 H 32 SH 18	AMSW-3WU		\$2240	2288	2313	2337	2360	2385	2409	2432	2459	2482	2506	2530	2555

COM Yardage: 1 or 2 seats: .75 yard
Contact Leland Customer Experience for yardage requirements on textiles with repeats.
Optional Glides: Add \$8.00 net per chair for a set of four (4)

To specify:
Please refer to pages 3-4 for complete specifying information.
Specify all products by their product code.

Pricing Effective: January 2024

AMADEUS COUNTER CHAIR, SLED BASE
Design: Martin Ballendat

AM13

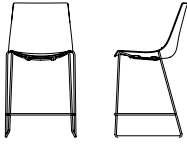

**Amadeus Counter Chair,
Sled Base**

	MODEL	FRAME FINISH	LIST PRICE
Polypropylene shell	AMCS-PO	Powder Coat	\$652
W 20.5 D 21.5 H 38.5 SH 26		Chrome	\$731

Optional Glides: Add \$8.00 net per chair for a set of four (4).

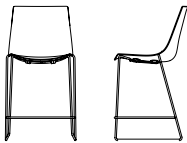

**Amadeus Counter Chair,
Sled Base**

	MODEL	LIST PRICE/GRADE	COM/COL	A	B	C	D	E	F	G	H	I	J	K	L
Polypropylene shell, upholstered seat onlay	AMCS-PU	Powder Coat	\$794	839	862	884	907	929	952	974	995	1019	1041	1063	1085
		Chrome	\$871	916	939	960	985	1007	1029	1051	1075	1096	1118	1142	1163

W 20.5 D 21.5 H 38.5 SH 26

COM Yardage: 1 or 2 seats: .75 yard
Contact Leland Customer Experience for yardage requirements on textiles with repeats.
For COL requirements please contact Leland Customer Experience.
Optional Glides: Add \$8.00 net per chair for a set of four (4).

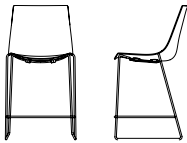

**Amadeus Counter Chair,
Sled Base**

	MODEL	LIST PRICE/GRADE	COM/ COL	A	B	C	D	E	F	G	H	I	J	K	L
Fully upholstered	AMCS-FU	Powder Coat	\$1015	1118	1169	1219	1270	1321	1372	1423	1473	1523	1573	1624	1674
		Chrome	\$1103	1205	1255	1306	1358	1409	1458	1509	1561	1612	1662	1711	1764

W 20.5 D 21.5 H 38.5 SH 26

COM Yardage: 1 seat: 1.5 yards
Contact Leland Customer Experience for yardage requirements on textiles with repeats.
For COL requirements please contact Leland Customer Experience.
Optional Glides: Add \$8.00 net per chair for a set of four (4).

To specify:
Please refer to pages 3-4 for complete specifying information.
Specify all products by their product code.

Pricing Effective: January 2024

AMADEUS COUNTER CHAIR, SLED BASE
Design: Martin Ballendat

AM14

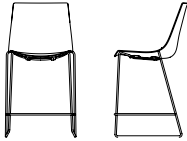

**Amadeus Counter Chair,
Sled Base**

	MODEL	FRAME FINISH	LIST PRICE
3D Beech veneer shell	AMCS-3DB	Powder Coat	\$1370
W 21 D 21.5 H 38.5 SH 26		Chrome	\$1454

Optional Glides: Add \$8.00 net per chair for a set of four (4).

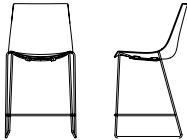

**Amadeus Counter Chair,
Sled Base**

	MODEL	LIST PRICE/ GRADE	COM/COL	A	B	C	D	E	F	G	H	I	J	K	L
3D Beech veneer shell, upholstered seat onlay	AMCS-3BU	Powder Coat	\$1522	1570	1595	1619	1642	1668	1691	1715	1739	1765	1788	1811	1836
		Chrome	\$1605	1654	1677	1703	1726	1750	1773	1799	1823	1846	1872	1895	1919

W 20.5 D 21.5 H 38.5 SH 26

COM Yardage: 1 or 2 seats: .75 yard
Contact Leland Customer Experience for yardage requirements on textiles with repeats.
Optional Glides: Add \$8.00 net per chair for a set of four (4).

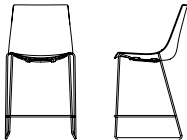

**Amadeus Counter Chair,
Sled Base**

	MODEL	FRAME FINISH	LIST PRICE
3D Walnut veneer shell	AMCS-3DW	Powder Coat	\$1555
W 20.5 D 21.5 H 38.5 SH 26		Chrome	\$1637

Optional Glides: Add \$8.00 net per chair for a set of four (4)..

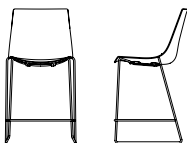

Amadeus Sled Base Chair

	MODEL	LIST PRICE/GRADE	COM/ COL	A	B	C	D	E	F	G	H	I	J	K	L
3D Walnut veneer shell, upholstered seat onlay	AMCS-3WU	Powder Coat	\$1706	1754	1778	1802	1826	1851	1875	1899	1924	1948	1971	1997	2019
		Chrome	\$1788	1836	1860	1884	1908	1933	1955	1982	2005	2030	2053	2078	2102

W 20.5 D 21.5 H 38.5 SH 26

COM Yardage: 1 or 2 seats: .75 yard
Contact Leland Customer Experience for yardage requirements on textiles with repeats.
Optional Glides: Add \$8.00 net per chair for a set of four (4).

To specify:
Please refer to pages 3-4 for complete specifying information.
Specify all products by their product code.

AMADEUS COUNTER CHAIR, WOOD BASE
Design: Martin Ballendat

AM15

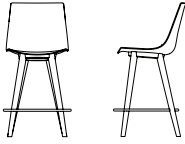

Amadeus Counter Chair

Wood Base

	MODEL	FRAME FINISH	LIST PRICE
Polypropylene shell	AMCW-PO		\$1253
W 20 D 22.5 H 40 SH 25.5		Optional Glides: Add \$8.00 net per chair for a set of four (4).	

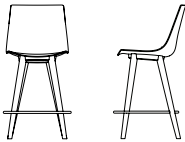

Amadeus Counter Chair

Wood Base

	MODEL	LIST PRICE/ GRADE	COM/ COL	A	B	C	D	E	F	G	H	I	J	K	L
Polypropylene shell, upholstered seat onlay	AMCW-PU		\$1393	1439	1462	1485	1507	1529	1553	1574	1597	1620	1642	1664	1688
W 20 D 22.5 H 40 SH 25.5			COM Yardage: 1 or 2 seats: .75 yard Contact Leland Customer Experience for yardage requirements on textiles with repeats. Optional Glides: Add \$8.00 net per chair for a set of four (4)												

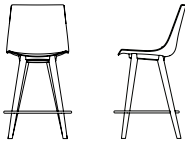

Amadeus Counter Chair

Wood Base

	MODEL	LIST PRICE/ GRADE	COM/ COL	A	B	C	D	E	F	G	H	I	J	K	L
Fully upholstered	AMCW-FU		\$1693	1796	1845	1897	1948	1999	2049	2100	2151	2202	2251	2303	2354
W 20 D 22.5 H 40 SH 25.5			COM Yardage: 1 seat: 1.5 yards Contact Leland Customer Experience for yardage requirements on textiles with repeats. Optional Glides: Add \$8.00 net per chair for a set of four (4).												

To specify:
Please refer to pages 3-4 for complete specifying information.
Specify all products by their product code.

Pricing Effective: January 2024

AMADEUS COUNTER CHAIR, WOOD BASE
Design: Martin Ballendat

AM16

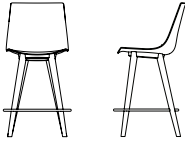

Amadeus Counter Chair

Wood Base	MODEL	FRAME FINISH	LIST PRICE
3D Beech veneer shell	AMCW-3DB		\$2150
W 20 D22.5 H 40 SH 25.5		Optional Glides: Add \$8.00 net per chair for a set of four (4).	

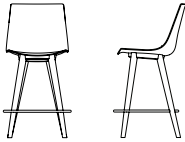

Amadeus Counter Chair
Wood Base

MODEL	LIST PRICE/ GRADE	COM/ COL	A	B	C	D	E	F	G	H	I	J	K	L
3D Beech veneer shell, upholstered seat onlay	AMCW-3BU	\$2300	2351	2375	2398	2423	2447	2469	2495	2518	2544	2568	2592	2616
W 20 D 22.5 H 40 SH 26		COM Yardage: 1 or 2 seats: .75 yard Contact Leland Customer Experience for yardage requirements on textiles with repeats. Optional Glides: Add \$8.00 net per chair for a set of four (4)												

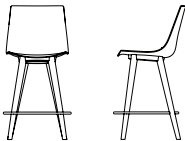

Amadeus Counter Chair
Wood Base

MODEL	FRAME FINISH	LIST PRICE
3D American walnut veneer shell	AMCW-3DW	\$2444
W 20 D22.5 H 40 SH 25.5	Optional Glides: Add \$8.00 net per chair for a set of four (4).	

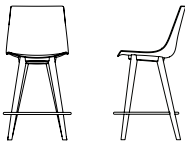

Amadeus Counter Chair
Wood Base

MODEL	LIST PRICE/ GRADE	COM/ COL	A	B	C	D	E	F	G	H	I	J	K	L
3D American walnut veneer shell, upholstered seat onlay	AMCW-3WU	\$2594	2642	2666	2691	2716	2740	2763	2789	2811	2836	2861	2884	2908
W 20 D 22.5 H 40 SH 26		COM Yardage: 1 or 2 seats: .75 yard Contact Leland Customer Experience for yardage requirements on textiles with repeats. Optional Glides: Add \$8.00 net per chair for a set of four (4)												

To specify:
Please refer to pages 3-4 for complete specifying information.
Specify all products by their product code.

AMADEUS BAR CHAIR, SLED BASE
Design: Martin Ballendat

AM17

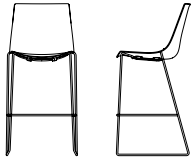

**Amadeus Bar Chair
Sled Base**

	MODEL	FRAME FINISH	LIST PRICE
Polypropylene shell	AMBS-PO	Powder Coat	\$741
W 20.5 D 21.5 H 43.75 SH 29		Chrome	\$808

Optional Glides: Add \$8.00 net per chair for a set of four (4).

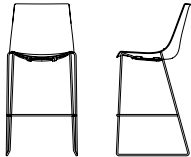

**Amadeus Bar Chair
Sled Base**

	MODEL	LIST PRICE/GRADE	COM/COL	A	B	C	D	E	F	G	H	I	J	K	L
Polypropylene shell upholstered seat onlay	AMBS-PU	Powder Coat	\$883	927	949	973	994	1017	1040	1062	1084	1108	1129	1152	1175
		Chrome	\$949	994	1017	1040	1062	1084	1108	1129	1152	1175	1197	1219	1243

W 21 D 21.5 H 44 SH 30

COM Yardage: 1 or 2 seats: .75 yard
Contact Leland Customer Experience for yardage requirements on textiles with repeats.
For COL requirements please contact Leland Customer Experience.
Optional Glides: Add \$8.00 net per chair for a set of four (4).

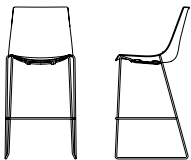

**Amadeus Bar Chair
Sled Base**

	MODEL	LIST PRICE/ GRADE	COM/COL	A	B	C	D	E	F	G	H	I	J	K	L
Fully upholstered	AMBS-FU	Powder Coat	\$1117	1218	1269	1320	1370	1422	1471	1521	1571	1623	1673	1725	1776
		Chrome	\$1192	1293	1345	1396	1446	1495	1548	1598	1648	1700	1750	1801	1852

W 20.5 D 21.5 H 43.75
SH 29

COM Yardage: 1 seat: 1.5 yards
Contact Leland Customer Experience for yardage requirements on textiles with repeats.
For COL requirements please contact Leland Customer Experience.
Optional Glides: Add \$8.00 net per chair for a set of four (4).

To specify:
Please refer to pages 3-4 for complete specifying information.
Specify all products by their product code.

Pricing Effective: January 2024

AMADEUS BAR CHAIR, SLED BASE
Design: Martin Ballendat

AM18

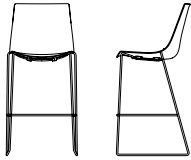

**Amadeus Bar Chair
Sled Base**

	MODEL	FRAME FINISH	LIST PRICE
3D Beech veneer shell	AMBS-3DB	Powder Coat	\$1466
W 20.5 D21.5 H 43.75 SH 29		Chrome	\$1537

Optional Glides: Add \$8.00 net per chair for a set of four (4).

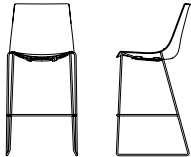

**Amadeus Bar Chair
Sled Base**

	MODEL	LIST PRICE/ GRADE	COM/COL	A	B	C	D	E	F	G	H	I	J	K	L
3D Beech veneer shell, upholstered onlay	AMBS-3BU	Powder Coat	\$1618	1666	1690	1712	1738	1762	1787	1810	1835	1859	1882	1907	1932
		Chrome	\$1689	1736	1761	1785	1809	1834	1858	1881	1906	1931	1953	1980	2003

W 21 D 21.5 H 44 SH 30

COM Yardage: 1 or 2 seats: .75 yard
Contact Leland Customer Experience for yardage requirements on textiles with repeats.
For COL requirements please contact Leland Customer Experience.
Optional Glides: Add \$8.00 net per chair for a set of four (4).

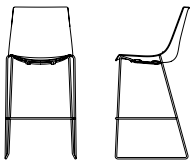

**Amadeus Bar Chair
Sled Base**

	MODEL	FRAME FINISH	LIST PRICE
3D Walnut veneer shell	AMBS-3DW	Powder Coat	\$1650
W 21 D21.5 H 44 SH 29.5		Chrome	\$1722

Optional Glides: Add \$8.00 net per chair for a set of four (4).

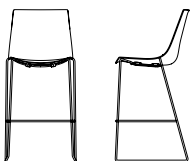

**Amadeus Bar Chair
Sled Base**

	MODEL	LIST PRICE/ GRADE	COM/ COL	A	B	C	D	E	F	G	H	I	J	K	L
3D Walnut veneer shell upholstered seat onlay	AMBS-3WU	Powder Coat	\$1801	1850	1874	1898	1921	1947	1970	1995	2018	2042	2067	2091	2115
		Chrome	\$1873	1920	1945	1969	1991	2017	2041	2065	2090	2114	2138	2163	2186

W 21 D 21.5 H 44 SH 30

COM Yardage: 1 or 2 seats: .75 yard
Contact Leland Customer Experience for yardage requirements on textiles with repeats.
For COL requirements please contact Leland Customer Experience.
Optional Glides: Add \$8.00 net per chair for a set of four (4).

**To specify:
Please refer to pages 3-4 for
complete specifying information.
Specify all products by their
product code.**

AMADEUS BAR CHAIR, WOOD BASE
Design: Martin Ballendat

AM19



Amadeus Bar Chair

Wood Base

	MODEL	FRAME FINISH	LIST PRICE
Polypropylene shell	AMBW-PO		\$1452
W 20 D22.5 H 44 SH 29		Optional Glides: Add \$8.00 net per chair for a set of four (4).	



Amadeus Bar Chair

Wood Base

	MODEL	LIST PRICE/ GRADE	COM/ COL	A	B	C	D	E	F	G	H	I	J	K	L
Polypropylene shell upholstered seat onlay	AMBW-PU		\$1593	1638	1661	1682	1706	1728	1750	1773	1796	1817	1841	1863	1884
W 20 D 22.5 H 44 SH 29.5		COM Yardage: 1 or 2 seats: .75 yard Contact Leland Customer Experience for yardage requirements on textiles with repeats. Optional Glides: Add \$8.00 net per chair for a set of four (4)													



Amadeus Bar Chair

Wood Base

	MODEL	LIST PRICE/ GRADE	COM/ COL	A	B	C	D	E	F	G	H	I	J	K	L
Fully upholstered	AMBW-FU		\$1918	2018	2071	2120	2171	2222	2274	2323	2375	2425	2478	2527	2577
W 20 D 22.5 H 44 SH 29.5		COM Yardage: 1 seat: 1.5 yards Contact Leland Customer Experience for yardage requirements on textiles with repeats. Optional Glides: Add \$8.00 net per chair for a set of four (4)													

To specify:

Please refer to pages 3-4 for complete specifying information. Specify all products by their product code.

Pricing Effective: January 2024

AMADEUS BAR CHAIR, WOOD BASE
Design: Martin Ballendat

AM20



Amadeus Bar Chair

Wood Base

	MODEL	FRAME FINISH	LIST PRICE
3D beech veneer shell	AMBW-3DB		\$2361
W 20 D 22.5 H 44 SH 29		Optional Glides: Add \$8.00 net per chair for a set of four (4).	

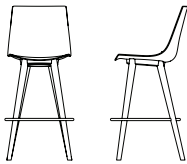

Amadeus Bar Chair

Wood Base

	MODEL	LIST PRICE/ GRADE	COM/ COL	A	B	C	D	E	F	G	H	I	J	K	L
3D beech veneer shell upholstered seat only	AMBW-3BU	\$2514		2561	2587	2611	2634	2660	2683	2707	2731	2756	2778	2804	2828
W 20 D 22.5 H 44 SH 29.5		COM Yardage: 1 or 2 seats: .75 yard Contact Leland Customer Experience for yardage requirements on textiles with repeats. Optional Glides: Add \$8.00 net per chair for a set of four (4)													

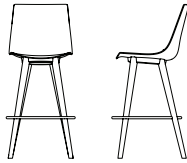

Amadeus Bar Chair

Wood Base

	MODEL	FRAME FINISH	LIST PRICE
3D american walnut veneer shell	AMBW-3DW		\$2717
W 20 D 22.5 H 44 SH 29		Optional Glides: Add \$8.00 net per chair for a set of four (4).	



Amadeus Bar Chair

Wood Base

	MODEL	LIST PRICE/ GRADE	COM/ COL	A	B	C	D	E	F	G	H	I	J	K	L
3D american walnut veneer shell, upholstered seat only	AMBW-3WU	\$2869		2917	2941	2964	2990	3012	3037	3060	3086	3110	3134	3158	3182
W 20 D 22.5 H 44 SH 29.5		COM Yardage: 1 or 2 seats: .75 yard Contact Leland Customer Experience for yardage requirements on textiles with repeats. Optional Glides: Add \$8.00 net per chair for a set of four (4)													

To specify:

Please refer to pages 3-4 for complete specifying information. Specify all products by their product code.

Pricing Effective: January 2024

AMADEUS TRANSPORT/STACKING DOLLY

Design: Martin Ballendat

AM21

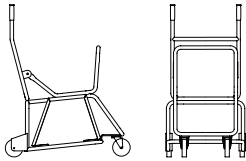

Amadeus

Sled Base

Transport/Stacking Dolly

MODEL

FRAME FINISH

LIST PRICE

Black powder coat finish

AMD-SB

\$875

W 23.5 D37.5 H 43
(Dimensions of dolly when empty)

Sled Base: 20 high on dolly (15 high on floor)

Weight with 20 high on dolly: 470 lbs

For use with all Amadeus sled base, side chairs with poly shells, wood shells, and upholstered onlay

**Arm, Counter, & Bar models do not stack

W 23.5 D37.5 H 70
(Dimensions with 20 poly or wood shell chairs stacked)

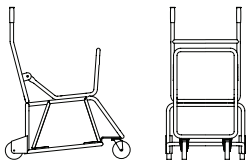

Amadeus

Four Leg Base

Transport/Stacking Dolly

MODEL

FRAME FINISH

LIST PRICE

Black powder coat finish

AMD-4L

\$1246

W 23.5 D37.5 H 43
(Dimensions of dolly when empty)

Four Leg Base: 12 high on dolly

Weight with 12 high on dolly: 350 lbs

For use with all shell types

**Arm, Counter, & Bar models do not stack

W 23.5 D37.5 H 65
(Dimensions with 12 poly or wood shell chairs stacked)

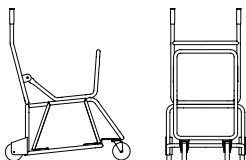

Amadeus

Sled Base, Fully Upholstered

Transport/Stacking Dolly

MODEL

FRAME FINISH

LIST PRICE

Black powder coat finish

AMD-SBFU

\$1542

W 23.5 D37.5 H 78
(Dimensions with 20 fully upholstered chairs stacked)

Sled Base: 20 high on dolly (15 high on floor)

Weight with 20 high on dolly: 530 lbs

For use with fully upholstered shell only

**Arm, Counter, & Bar models do not stack

To specify:

Please refer to pages 3-4 for complete specifying information.

Specify all products by their product code.

Pricing Effective: January 2024

**5695 Eagle Drive, SE
Grand Rapids,
Michigan 49512
616-975-9260
lelandfurniture.com**

Baraga

August 2024 Price List



Baraga

Table of Contents	BA2
Specification Information	BA3
Specification Example	BA4
Bar Stool	BA5
Counter Stool	BA5
Low Stool	BA5

Chair Model

DESCRIPTION	CODE
Baraga Bar Stool	BARB
Baraga Counter Stool	BARC
Baraga Low Stool	BARS

Seat Type

DESCRIPTION	CODE
Oak	O
Walnut	W
Felt	F

Wood Seat Finish

DESCRIPTION	CODE
Natural Walnut	08M
Natural White Oak	12M
Morel	66M
Evergreen	112M
Sienna	113M
Blue Sky	114M

Felt Seat Finish

DESCRIPTION	CODE
Abalone	PET01
Salmon	PET02
Sandstone	PET03
Bark	PET04
Amarillo	PET05
Shamrock	PET06
Burnt Clay	PET07
Merlot	PET08
Royal	PET09
Indigo	PET10
Turmeric	PET11
Laurel	PET12
Charcoal	PET13

Powder Coat Frame Finish

DESCRIPTION	CODE
Black Textured	BT
White Textured	WT
Matte Mercury	MMR
Matte Burnish	MBN
Matte Foundry	MFN
Matte Pine	MPN
Matte Sienna	MSN
Matte Blue Sky	MBS

Glide Type

STANDARD:

DESCRIPTION	CODE
Nylon	S

OPTIONAL:

Please note that optional glides raise the chair height .5 inch.

DESCRIPTION	CODE
Felt	FC

Stacking note

The Baraga stool does not stack.

Specifications required to create the product code

- Model
- Wood Species
- Seat Finish
- Frame Finish
- Glide Type

B A R C - F - P E T 1 1 - B T - S

MODEL

Baraga Counter Stool

SEAT TYPE

Felt (F)

SEAT FINISH

Turmeric (PET11)

FRAME FINISH

Black Textured (BT)

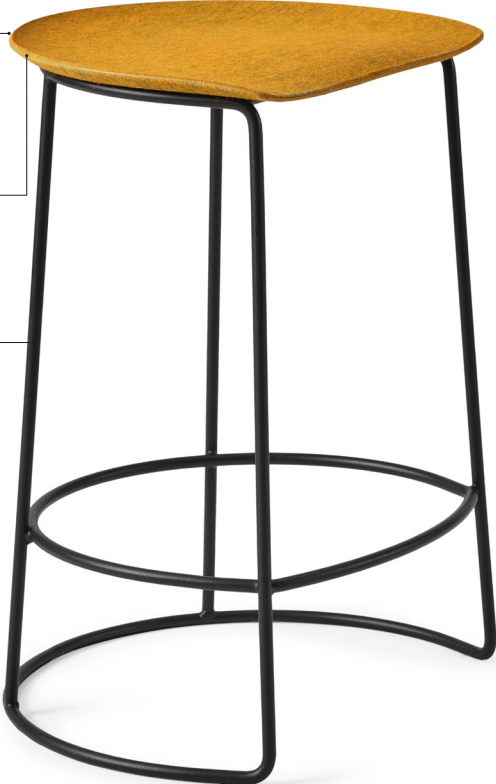

BARAGA STOOL
Design: Altherr Désile Park

BA5



Baraga Bar Stool

	MODEL	SEAT TYPE	LIST PRICE
Powder Coat Frame	BARB-O	Oak	\$1011
W 20 D 16 H 30	BARB-W	Walnut	\$1021
	BARB-F	Felt	\$1037

Optional Glides: Add \$8.00 net per chair for a set of four (4). Optional Glides raise chair height .5 inch.



Baraga Counter Stool

	MODEL	SEAT TYPE	LIST PRICE
Powder Coat Frame	BARC-O	Oak	\$980
W 20 D 16 H 25	BARC-W	Walnut	\$999
	BARC-F	Felt	\$1015

Optional Glides: Add \$8.00 net per chair for a set of four (4). Optional Glides raise chair height .5 inch.



Baraga Low Stool

	MODEL	SEAT TYPE	LIST PRICE
Powder Coat Frame	BARS-O	Oak	\$966
W 19 D 15 H 18	BARS-W	Walnut	\$977
	BARS-F	Felt	\$992

Optional Glides: Add \$8.00 net per chair for a set of four (4). Optional Glides raise chair height .5 inch.

To specify:
Please refer to pages 3-4 for complete specifying information.
Specify all products by their product code.

Pricing Effective: January 2024

5695 Eagle Drive, SE
Grand Rapids,
Michigan 49512
616-975-9260
lelandfurniture.com

Brit Bench Metallic

January 2024 Price List

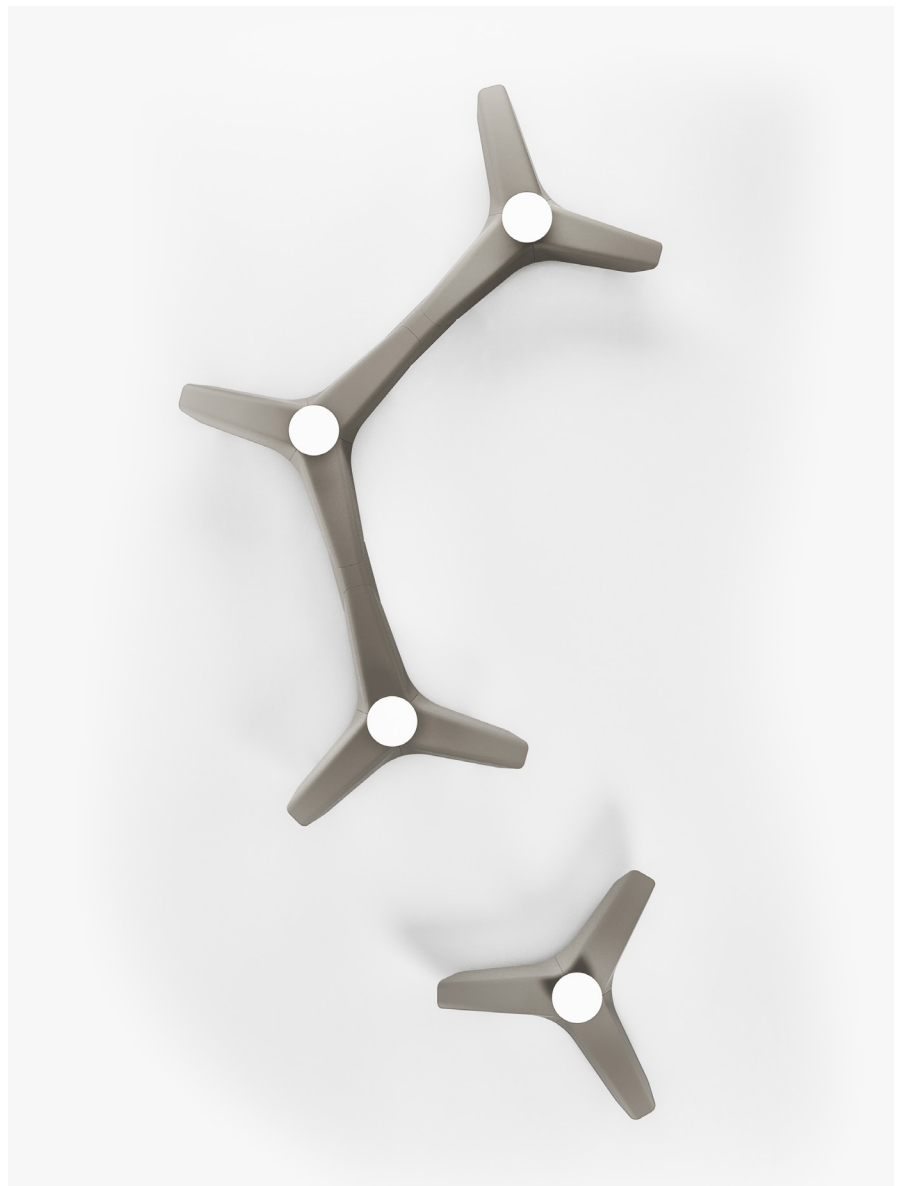

Brit Bench Metallic

Table of Contents	BBM2
Specification Information	BBM3
Specification Example	BBM4
Powder Coat Steel, Upholstered Seat Onlay	BBM5
Auxiliary Options	BBM6
Link Specification Information	BBM7
Link Specification Example	BBM8
Brit Bench Metallic Link	BBM9
Auxiliary Options	BBM10

Bench Model

DESCRIPTION	CODE
Brit Bench metallic powder coat steel	BBPC
Brit Bench metallic powder coat steel, with powder coat steel table	BBPCT
Brit Bench metallic powder coat steel, upholstered onlay	BBPCU with
Brit Bench metallic powder coat steel, with powder steel table, with upholstered onlay	BBPCTU coat

Leg Finish

DESCRIPTION	CODE
Brushed Stainless Steel	BSS
Black Powder Coat	BPC

Powder Coat Steel Finish

DESCRIPTION	CODE
Black Textured Powder Coat	BT
Soda Red Textured	SRT
Dolphin Textured	DLT
Oxford Textured	OXT
Tangerine Textured	TNT
Ice Blue Textured	IBT
Artic Textured	ART
Caribbean Textured	CBT
Limelight Textured	LLT
Ink Textured	IN

Upholstered Onlay Selection

Please refer to Leland Textile Program which features textiles and leathers from the following partners:

- Camira
- Carnegie
- CF Stinson
- Green Hides
- Maharam
- Unika Vaev

The complete grade list can be found on our website or you can specify COM/COL. Due to the design of this product, it is recommended that all non pre-approved textile be tested for compatibility.

Upholstered onlay is not an option for the Brit Bench Metallic link.

Table Top Surface

DESCRIPTION	CODE
Corian® Solid Surface Solid with 0.5" square edge	SSS

Contact Corian® Solid Surface for current solid and pattern availability. A custom quote is required for all solid surface. Please contact Leland Customer Experience to request a custom quote.

Auxiliary Options

DESCRIPTION	CODE
Brit Bench Electrical outlets, (with table)	BBE0
Brit Bench Floor Mount	BBFM
Brit Bench Security Pan	BSP
Outdoor Treatment	OT

Glides

Brit Bench glides are nylon.

Product Specification

Brit Bench product layout is required at the quotation stage and order stage to ensure accurate product specifications. Contact Leland Customer Experience for CAD symbols.

Shipment Detail

Please note that Brit Bench products will be shipped unassembled. Please contact Customer Experience if assembled shipment is desired as additional charges will apply.

Specifications required to create the product code

BRIT BENCH METALLIC (WITHOUT TABLE)

- Model
- Leg Finish
- Powder Coat Steel Finish (when applicable)
- Upholstery Selection (when applicable)
- Auxiliary Options (when applicable)



BRIT BENCH METALLIC (WITH TABLE)

- Model
- Leg Finish
- Powder Coat Steel Finish (when applicable)
- Upholstered Onlay Selection (when applicable)
- Table Top Surface
- Surface Color (when applicable)
- Auxiliary Options (when applicable)



MODEL

Brit Bench Metallic Powder Coat Steel, with Powder Coat Steel Table (BBPCT)

LEG FINISH

Brushed Stainless Steel (BPC)

POWDER COAT STEEL FINISH

Soda Red Textured (SRT)

UPHOLSTERED ONLAY SELECTION

When applicable, enter upholstery grade, COM or COL

TABLE TOP SURFACE

SSS

TOP SURFACE COLOR

Corian® White Solid Surface (CW)

AUXILIARY OPTIONS

When applicable, enter auxiliary option code

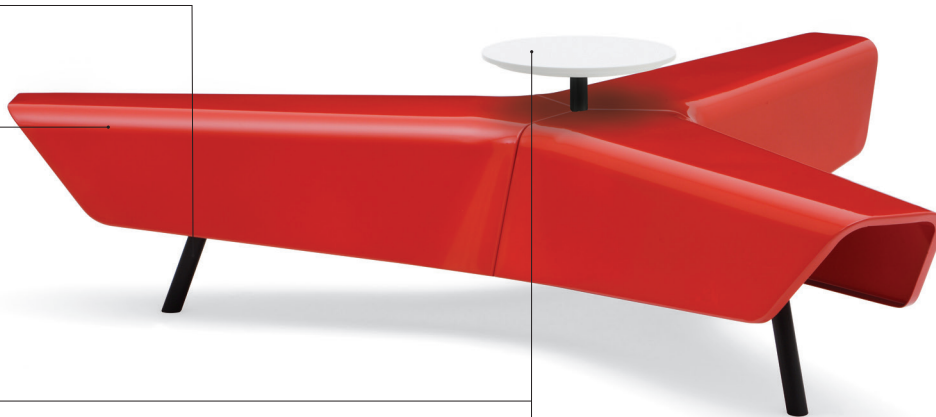

BRIT BENCH METALLIC POWDER COAT STEEL
 Design: Simon Pengelly

BBM5



Brit Bench Metallic	MODEL		LIST PRICE
Powder coat steel	BBPC 1-3 units	10393	\$10393
W 81 SH 18.5	BBPC 4+ units	8952	\$8952

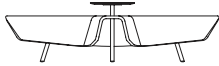

Brit Bench Metallic	MODEL		LIST PRICE
Powder coat steel, steel table	BBPCT 1-3 units		\$11931
W 81 SH 18.5	BBPCT 4+ units		\$10488

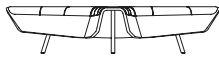

Brit Bench Metallic	MODEL	LIST PRICE/GRADE	COM/ COL	A	B	C	D	E	F	G	H	I	J	K	L
Powder coat steel upholstered seat onlay	BBPCU 1-3 units		\$ 11122	11441	11603	11762	11923	12085	12245	12406	12566	12727	12887	13050	13209
	BBPCU 4+ units		\$ 9678	10000	10159	10320	10481	10641	10801	10964	11123	11284	11446	11606	11767

W 81 SH 19.5

COM Yardage: 1 bench: 4 yards
 For COL requirements please contact Leland Customer Experience.



Brit Bench Metallic	MODEL	LIST PRICE/ GRADE	COM/ COL	A	B	C	D	E	F	G	H	I	J	K	L
Powder coat steel, steel table upholstered seat onlay	BBPCTU 1-3 units		\$ 12655	12975	13136	13299	13458	13619	13780	13941	14101	14263	14423	14583	14743
	BBPCTU 4+ units		\$ 11215	11534	11694	11856	12016	12177	12339	12497	12658	12819	12981	13140	13302

W 81 SH 19.5

COM Yardage: 1 bench: 4 yards
 For COL requirements please contact Leland Customer Experience.

Brit Bench Table Top	MODEL	
Corian® Solid Surface Circular Top	SSS	
Contact Corian® Solid Surface for current solid and pattern availability. A custom quote is required for all solid surface. Please contact Leland Customer Experience to request a custom quote.		

To specify:
 Please refer to pages 3-4 for complete specifying information. Specify all products by their product code.

Pricing Effective: January 2024

BRIT BENCH METALLIC AUXILIARY OPTIONS

Design: Simon Pengelly

BBM6

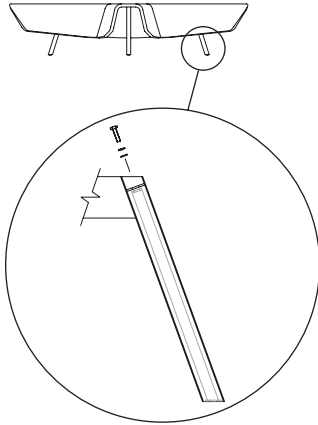

Brit Bench Floor Mount	MODEL	LIST PRICE
	BBFM	\$217

Due to the variety of floor surfaces on which the Brit Bench may be installed, floor mount fasteners are not supplied by Leland International. The Brit Bench floor mount feature consists of legs with floor mount brackets designed to use .3125 thread diameter fasteners. Responsibility of fastener choice is the customers. Brit Bench Floor Mount must be specified at the time of purchasing. The Floor Mount cannot be added later in the field.

Brit Bench Security Pan	MODEL	LIST PRICE
	BBSP	\$1814

Brit Bench Electrical Outlet	MODEL	LIST PRICE
For table	BBEO	\$1201

Brit Bench electrical outlet option is not standard for all Brit Bench tables. Electrical outlet is located under the table edge, therefore a Brit Bench with table must be specified when specifying electrical outlet option. Brit Bench electrical outlet option features one 120v AC receptacle.

Outdoor Treatment	MODEL	LIST PRICE
powder coat steel bench	OT	\$400

To specify:
 Please refer to pages 3-4 for complete specifying information.
 Specify all products by their product code.

Pricing Effective: January 2024

Link Model

DESCRIPTION	CODE
Brit Bench Metallic Link powder coat steel	BBLPC

Powder Coat Steel Finish

DESCRIPTION	CODE
White Textured Powder Coat	WT
Black Textured Powder Coat	BT
Grey Textured Powder Coat	GT
Soda Red Textured	SRT
Dolphin Textured	DLT
Oxford Textured	OXT
Tangerine Textured	TNT
Ice Blue Textured	IBT
Artic Textured	ART
Caribbean Textured	CBT
Limelight Textured	LLT
Ink Textured	IN

Auxiliary Options

DESCRIPTION	CODE	DESCRIPTION	CODE
Brit Bench Link Security Pan			BBLSP
Outdoor Treatment			OT

Product Specification

Brit Bench product layout is required at the quotation stage and order stage to ensure accurate product specifications. Contact Leland Customer Experience for CAD symbols.

Shipment Details

Please note that Brit Bench products will be shipped unassembled.
Please contact Customer Experience if assembled shipment is desired as additional charges will apply.

Specifications required to create the product code

- Model
- Powder Coat Steel Finish (when applicable)
- Upholstery Selection (when applicable)
- Outdoor Treatment (when applicable)
- Auxiliary Options (when applicable)



MODEL

Brit Bench Metallic Link Powder Coat Steel (BBLPC)

POWDER COAT STEEL FINISH

Artic Textured (ART)

OUTDOOR TREATMENT

When applicable

AUXILIARY OPTIONS

When applicable, enter auxiliary option code

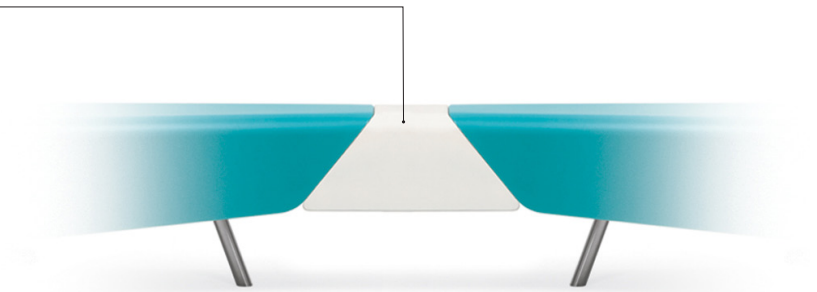

BRIT BENCH METALLIC LINK
Design: Simon Pengelly

BBM9

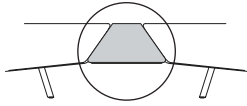

Brit Bench Metallic Link	MODEL	FRAME FINISH	LIST PRICE
powder coat steel link	BBLPC		\$1220

W 7.875

Upholstered onlay is not an option for the Brit Bench Metallic Powder Coat Steel Link.

To specify:
Please refer to pages 3-4 for complete specifying information.
Specify all products by their product code.

Pricing Effective: January 2024

Brit Bench Link Security Pan	MODEL	FRAME FINISH	LIST PRICE
	BBLSP		\$408

Brit Bench Link Security Pan must be specified at the time of purchasing.
The Link Security Pan cannot be added later in the field.

Outdoor Treatment	MODEL	FRAME FINISH	LIST PRICE
powder coat steel link	OT		\$134

To specify:
Please refer to pages 3-4 for
complete specifying information.
Specify all products by their
product code.

**5695 Eagle Drive, SE
Grand Rapids,
Michigan 49512
616-975-9260
lelandfurniture.com**

Bimini

January 2024 Price List



Bimini

Table of Contents	BI-2
Specification Information	BI-3
Specification Example	BI-4
Bimini Order Diagram	BI-5
Bimini High Panel	BI-6
Bimini Low Panel	BI-7
Bimini Accessory	BI-8
Bimini Auxiliary	BI-9

Bimini Model

DESCRIPTION	CODE
Bimini High Panel Desk Height	BIHD
Bimini High Panel Counter Height	BIHC
Bimini High Panel Free Standing	BIHF
Bimini Low Panel Desk Height	BILD
Bimini Low Panel Counter Height	BILC
Bimini Low Panel Free Standing	BILF

Panel Finish

DESCRIPTION	CODE
Abalone	PET01
Shamrock	PET06
Burnt Clay	PET07
Merlot	PET08
Royal	PET09
Turmeric	PET11
Laurel	PET12
Charcoal	PET13

Top Type

DESCRIPTION	CODE
Oak	O
Walnut	W
Laminate	L

Top Finish Options

OAK FINISH OPTIONS

DESCRIPTION	CODE
Natural White Oak	12M
Morel	66M

WALNUT FINISH OPTIONS

DESCRIPTION	CODE
Natural Walnut	08M

LAMINATE FINISH OPTIONS

DESCRIPTION	CODE
Platinum Wilsonart® (D315-60)	LGP
Black Pionite® (SE101)	LBK
White Wilsonart® (D354-60)	LWH

Rail Finish

DESCRIPTION	CODE
Black Textured	BT

Table Accessory Position 1-5 Option

DESCRIPTION	CODE
Salt USB	USB
Pepper Power	PWR
Pippa Light	PPL
Monitor Mount & Grommet (Left side)	GML
Monitor Mount & Grommet (Right side) (White or Black)	GMR

Auxiliary Options

DESCRIPTION	CODE
Coat Hook	CHK
Bag Hook	BHK
Customizable Signage	CSG
Linking Set 2 Panels	2LS
Linking Set 3 Panels	3LS

Table Edge Type

DESCRIPTION	CODE
1" flat plywood	W2



Specifications required to create the product code

- Model
- Panel Finish
- Top Type
- Top Finish
- Rail Finish
- Table Accessory Option
- Auxiliary Option



MODEL

Bimini High Panel Desk Height (BIHD)

PANEL FINISH

Royal (PET11)

TOP TYPE

Laminate (L)

TOP FINISH

Designer White D354-60 (LWH)
(when applicable)

RAIL FINISH

Black Textured (BT)



1. Accessorize your Bimini

Please complete and include with your order. If multiple units are ordered, a diagram must be completed for each unique unit.

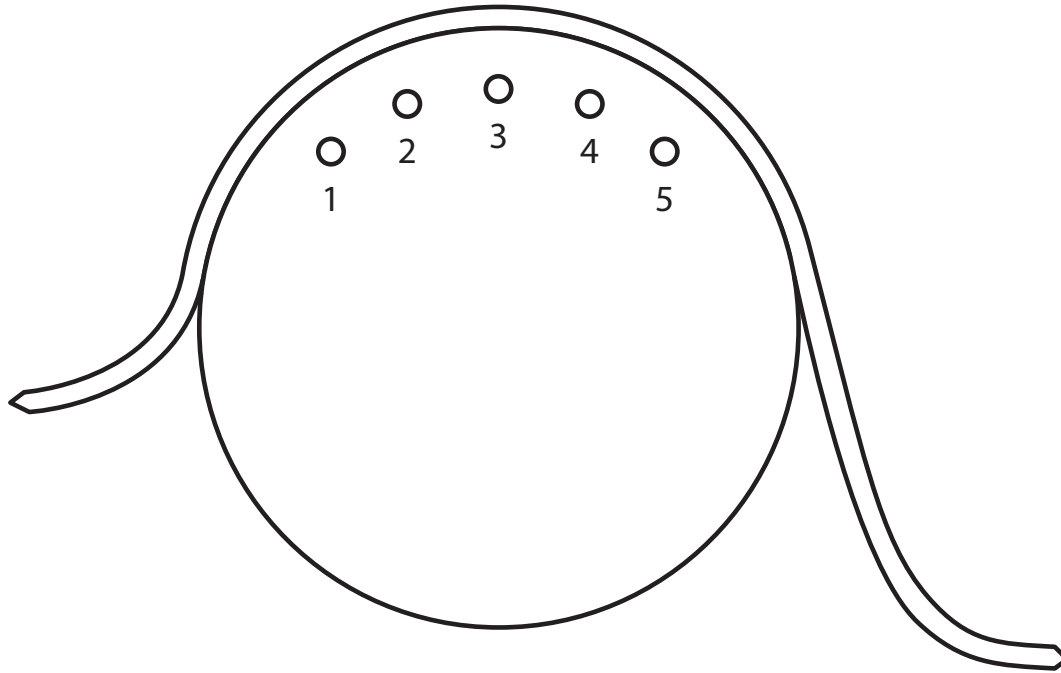

2. Check the box that fits your need

Salt (any position on table), Pepper (any position on table), Pippa (any position if no Monitor Mount). Monitor (any position on table with grommet in position next to mount) Monitors (less than 24") and Pippa (mount in 1 or 2 and Pippa in 5/Pippa in 1 and mount in 4 or 5), Monitors (24"-32") and Pippa (mount in 1 and Pippa in 5/Pippa in 1 and mount in 5).

POSITION ONE	POSITION TWO	POSITION THREE	POSITION FOUR	POSITION FIVE
<input type="checkbox"/> No Accessory Accessory <input type="checkbox"/> Salt USB <input type="checkbox"/> Pepper Power <input type="checkbox"/> Pippa Light <input type="checkbox"/> Monitor Mount & Grommet (Right Side)	<input type="checkbox"/> No Accessory Accessory <input type="checkbox"/> Salt USB <input type="checkbox"/> Pepper Power <input type="checkbox"/> Pippa Light <input type="checkbox"/> Monitor Mount & Grommet (Right Side) <input type="checkbox"/> Monitor Mount & Grommet (Left Side)	<input type="checkbox"/> No Accessory Accessory <input type="checkbox"/> Salt USB <input type="checkbox"/> Pepper Power <input type="checkbox"/> Pippa Light <input type="checkbox"/> Monitor Mount & Grommet (Right Side) <input type="checkbox"/> Monitor Mount & Grommet (Left Side)	<input type="checkbox"/> No Accessory Accessory <input type="checkbox"/> Salt USB <input type="checkbox"/> Pepper Power <input type="checkbox"/> Pippa Light <input type="checkbox"/> Monitor Mount & Grommet (Right Side) <input type="checkbox"/> Monitor Mount & Grommet (Left Side)	<input type="checkbox"/> No Accessory Accessory <input type="checkbox"/> Salt USB <input type="checkbox"/> Pepper Power <input type="checkbox"/> Pippa Light <input type="checkbox"/> Monitor Mount & Grommet (Left Side)

BIMINI, HIGH PANEL
 Design: Altherr Désile Park

BI-6

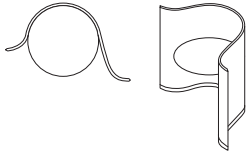

Bimini

High Panel, Desk Height

	MODEL	BASE	LAMINATE TOP	WALNUT TOP	OAK TOP
56" Panel, 29" Height Table	BIHD	Powder Coat	\$5790	\$5975	\$5975

W69, D43.5, H56, TH29

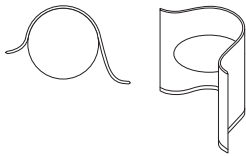

Bimini

High Panel, Counter Height

	MODEL	BASE	LAMINATE TOP	WALNUT TOP	OAK TOP
56" Panel, 36" Height Table	BIHC	Powder Coat	\$5990	\$6175	\$6175

W69, D43.5, H56, TH36

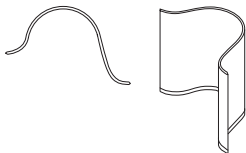

Bimini

High Panel Free Standing

	MODEL	BASE	LIST PRICE
56" Panel	BIHF	Powder Coat	\$4975

W69, D43.5, H56

To specify:
 Please refer to pages 3-4 for complete specifying information.
 Specify all products by their product code.

Pricing Effective: January 2024

BIMINI, LOW PANEL
 Design: Altherr Désile Park

BI-7

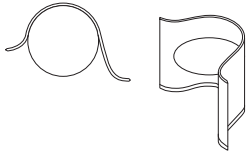

Bimini

Low Panel, Desk Height

	MODEL	BASE	LAMINATE TOP	WALNUT TOP	OAK TOP
48" Panel, 29" Height Table	BIHD	Powder Coat	\$5640	\$5825	\$5825

W69, D43.5, H48, TH29

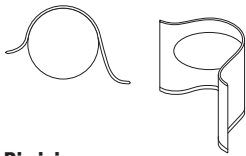

Bimini

Low Panel, Counter Height

	MODEL	BASE	LAMINATE TOP	WALNUT TOP	OAK TOP
48" Panel, 36" Height Table	BIHC	Powder Coat	\$5840	\$6025	\$6025

W69, D43.5, H48, TH36

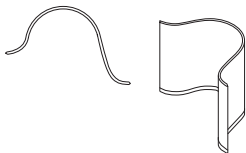

Bimini

Low Panel Free Standing

	MODEL	BASE	LIST PRICE
48" Panel	BIHF	Powder Coat	\$4775

W69, D43.5, H48

To specify:
 Please refer to pages 3-4 for complete specifying information.
 Specify all products by their product code.

Pricing Effective: January 2024



Salt-Dual USB charger	MODEL		LIST PRICE
White, Black	USB	Starter Unit (Includes one Salt and four port power box)	\$655
Dia 2" H 0.125"		Add on Unit (includes one salt only)	\$255

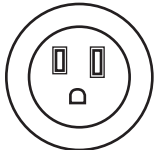

Pepper-Power Receptacle	MODEL		LIST PRICE
White, Black	PWR	Starter Unit (Includes one Pepper and four port power box)	\$543
Dia 2" H 0.125"		Add on Unit (includes one pepper only)	\$143

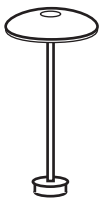

Pippa Light	MODEL		LIST PRICE
White, Black	PPL	Starter Unit (Includes one Pippa light and four port power box)	\$875
Dia 6.29" H 16.125"		Add on Unit (includes one Pippa light only)	\$475

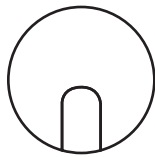
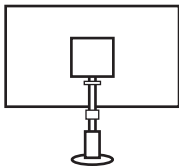

Monitor Mount & Grommet	MODEL		LIST PRICE
White, Black	MMT	Starter Unit (Includes one Monitor Mount with Grommet and four port power box)	\$855
		Add on Unit (includes one Monitor Mount with Grommet only)	\$455

*One Starter Unit required per Bimini
 *Power box has 12' cord length

To specify:
 Please complete diagram on page 5
 Specify all products by their
 product code.



Customizable Signage	MODEL	LIST PRICE
Alphanumeric Character	CSG	\$459
Dia 6" Decal 4"		

Bag Hook	MODEL	LIST PRICE
Under Table Top	BHK	\$168



Coat Hook	MODEL	LIST PRICE
Oak Or Walnut	CHK	\$245
Dia 3.15"		
Coat Hook Located on inside of Panel, 4" from top and 10" from Right hand side		



Link Set	MODEL	LIST PRICE
Link 2 Bimini	2LS	\$235



120 Link Set	MODEL	LIST PRICE
Link 3 Bimini	3LS	\$265

To specify:
 Please refer to pages 3-4 for complete specifying information.
 Specify all products by their product code.

**5695 Eagle Drive, SE
Grand Rapids,
Michigan 49512
616-975-9260
lelandfurniture.com**

Beach Stone Collection

January 2024 Price List



Beach Stones

Table of Contents	BS2
Specification Information	BS3
Specification Example	BS4
Seating	BS5
Tables	BS7

Model

DESCRIPTION	CODE
Beach Stone E	BSE
Beach Stone E with casters	BSEM
Beach Stone F	BSF
Beach Stone F with casters	BSFM
Beach Stone G	BSG
Beach Stone G with casters	BSGM
Beach Stone H	BSH
Beach Stone I	BSI
Beach Stone J	BSJ
Beach Stone K	BSK
Beach Stone L	BSL

Product Weights

DESCRIPTION	LBS
Beach Stone E - BSE	50
Beach Stone F - BSF	50
Beach Stone G - BSG	50
Beach Stone H - BSH	50
Beach Stone I - BSI	50
Beach Stone J - BSJ	50
Beach Stone K - BSK	50
Beach Stone L - BSL	50

Upholstery Selection

Please refer to freshcoast Textile Program which features textiles and leathers from the following partners:

- Camira
- Carnegie
- CF Stinson
- Green Hides
- Maharam
- Unika Vaev

The complete grade list can be found at www.fc.studio/textile-partners or you can specify COM/COL. Due to the design of this product, it is recommended that all non pre-approved textile be tested for compatibility.

Contact freshcoast for yardage requirements on textiles with repeats.

Base Finish

Black textured powder coat

Table Top Finish

LAMINATE

DESCRIPTION	CODE
Black Laminate	LBK
White Laminate	LWH

SOLID SURFACE

DESCRIPTION	CODE
Black Corian®	CB
White Corian®	CW
Grey Corian®	CG

GLASS

DESCRIPTION	CODE
Black Back Painted Glass	BG
White Back Painted Glass	WG

Specifications required to create the product code

- Model
- Upholstery Selection
- Table Top Finish (when applicable)
- Caster Option (when applicable)

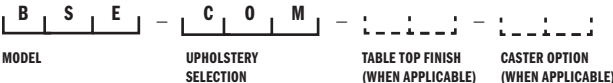

MODEL

Beach Stone E

UPHOLSTERY SELECTION

Upholstered (COM)





Beach Stone E

	MODEL	COM/COL	A	B	C	D	E	F	G	H	I	J	K	L
Fully upholstered	BSE	\$1615	1806	1903	2000	2095	2192	2287	2383	2480	2575	2671	2768	2864
W 32 D 24 H 25 SH 18														
			COM Yardage: 2.5 yards Contact freshcoast customer care for COL requirements, textile testing requirements and yardage requirements for textiles with repeats.											

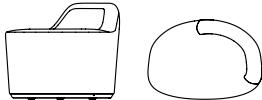

Beach Stone E with casters

	MODEL	COM/COL	A	B	C	D	E	F	G	H	I	J	K	L
Fully upholstered locking caster base	BSEM-HF	\$1685	1876	1972	2069	2165	2261	2357	2452	2549	2644	2740	2838	2933
Hard or soft floor casters	BSEM-SF	\$1699	1890	1987	2084	2179	2276	2371	2467	2564	2659	2755	2852	2948
W 21 D 24 H 25.25 SH 18.25														
			COM Yardage: 2.5 yards Contact freshcoast customer care for COL requirements, textile testing requirements and yardage requirements for textiles with repeats.											



Beach Stone F

	MODEL	COM/COL	A	B	C	D	E	F	G	H	I	J	K	L
Fully upholstered	BSF	\$1589	1780	1876	1973	2069	2165	2261	2357	2452	2549	2644	2741	2838
W 32 D 24 H 26 SH 18														
			COM Yardage: 2.5 yards Contact freshcoast customer care for COL requirements, textile testing requirements and yardage requirements for textiles with repeats.											

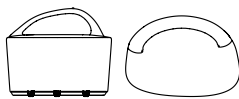

Beach Stone F with casters

	MODEL	COM/COL	A	B	C	D	E	F	G	H	I	J	K	L
Fully upholstered locking caster base	BSFM-HF	\$1658	1850	1945	2043	2138	2234	2330	2426	2522	2618	2714	2810	2907
Hard or soft floor casters	BSFM-SF	\$1673	1864	1960	2057	2153	2249	2345	2441	2536	2633	2728	2825	2922
W 32 D 24 H 26.25 SH 18.25														
			COM Yardage: 2.5 yards Contact freshcoast customer care for COL requirements, textile testing requirements and yardage requirements for textiles with repeats.											

To specify:
Please refer to pages 3-4 for complete specifying information.
Specify all products by their product code.



Beach Stone G

	MODEL	COM/COL	A	B	C	D	E	F	G	H	I	J	K	L
Fully upholstered	BSG	\$1608	1801	1897	1993	2089	2184	2280	2377	2472	2569	2665	2761	2856

W 32 D 24 H 31 SH 18

COM Yardage: 2.5 yards
 Contact freshcoast customer care for COL requirements, textile testing requirements and yardage requirements for textiles with repeats.

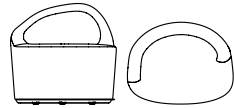

Beach Stone G with casters

	MODEL	COM/COL	A	B	C	D	E	F	G	H	I	J	K	L
Fully upholstered locking caster base	BSGM-HF	\$1677	1871	1966	2063	2158	2254	2349	2446	2541	2638	2735	2830	2926
Hard or soft floor casters	BSGM-SF	\$1692	1885	1981	2077	2173	2268	2364	2461	2556	2653	2749	2845	2940

W 32 D 24 H 31.25 SH 18.25

COM Yardage: 2.5 yards
 Contact freshcoast customer care for COL requirements, textile testing requirements and yardage requirements for textiles with repeats.



Beach Stone H

	MODEL	COM/COL	A	B	C	D	E	F	G	H	I	J	K	L
Fully upholstered	BSH	\$1071	1263	1359	1456	1551	1648	1743	1839	1936	2031	2127	2224	2320

W 48 D 18 H 18

COM Yardage: 2.5 yards
 Contact freshcoast customer care for COL requirements, textile testing requirements and yardage requirements for textiles with repeats.



Beach Stone I

	MODEL	COM/COL	A	B	C	D	E	F	G	H	I	J	K	L
Fully upholstered	BSI	\$965	1094	1157	1221	1285	1349	1413	1477	1540	1605	1668	1733	1797

W 33 D 22 H 18

COM Yardage: 1.75 yards
 Contact freshcoast customer care for COL requirements, textile testing requirements and yardage requirements for textiles with repeats.

To specify:
 Please refer to pages 3-4 for complete specifying information.
 Specify all products by their product code.



Beach Stone J

	MODEL	TOP FINISH	COM/COL	A	B	C	D	E	F	G	H	I	J	K	L
Upholstered w/ table	BSJ	Laminate	\$1128	1191	1224	1255	1287	1319	1352	1383	1416	1447	1479	1511	1544
		Corian	\$1691	1788	1836	1882	1930	1979	2028	2075	2124	2172	2218	2266	2315

W 17 D 13 H 22

COM Yardage: 1 yards

Contact freshcoast customer care for COL requirements, textile testing requirements and yardage requirements for textiles with repeats.

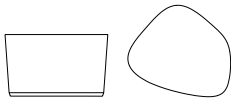

Beach Stone K

	MODEL	TOP FINISH	COM/COL	A	B	C	D	E	F	G	H	I	J	K	L
Upholstered w/ table	BSK	Laminate	\$1128	1255	1319	1383	1447	1511	1574	1640	1703	1768	1832	1896	1960
		Corian	\$1691	1882	1979	2075	2172	2266	2363	2460	2554	2652	2747	2844	2938

W 30 D 27 H 18

COM Yardage: 2 yards

Contact freshcoast customer care for COL requirements, textile testing requirements and yardage requirements for textiles with repeats.

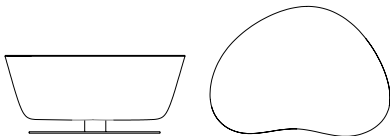

Beach Stone L

	MODEL	TOP FINISH	COM/COL	A	B	C	D	E	F	G	H	I	J	K	L
Upholstered w/ table	BSL	Laminate	\$3526	3719	3814	3911	4006	4102	4197	4294	4391	4486	4583	4678	4774
		Corian	\$5290	5578	5721	5866	6009	6153	6296	6441	6586	6730	6874	7018	7161

W 47 D 34 H 20

COM Yardage: 3 yards

Contact freshcoast customer care for COL requirements, textile testing requirements and yardage requirements for textiles with repeats.



Beach Stone L

	MODEL	COM/COL	A	B	C	D	E	F	G	H	I	J	K	L
Upholstered w/ backpainted glass	BSL	\$3848	4040	4135	4231	4328	4423	4520	4616	4712	4807	4904	5000	5095

W 33 D 22 H 18

COM Yardage: 3 yards

Contact freshcoast customer care for COL requirements, textile testing requirements and yardage requirements for textiles with repeats.

To specify:

Please refer to pages 3-4 for complete specifying information.

Specify all products by their product code.

**5695 Eagle Drive, SE
Grand Rapids,
Michigan 49512
616-975-9260
lelandfurniture.com**

Cambre Table

January 2024 Price List

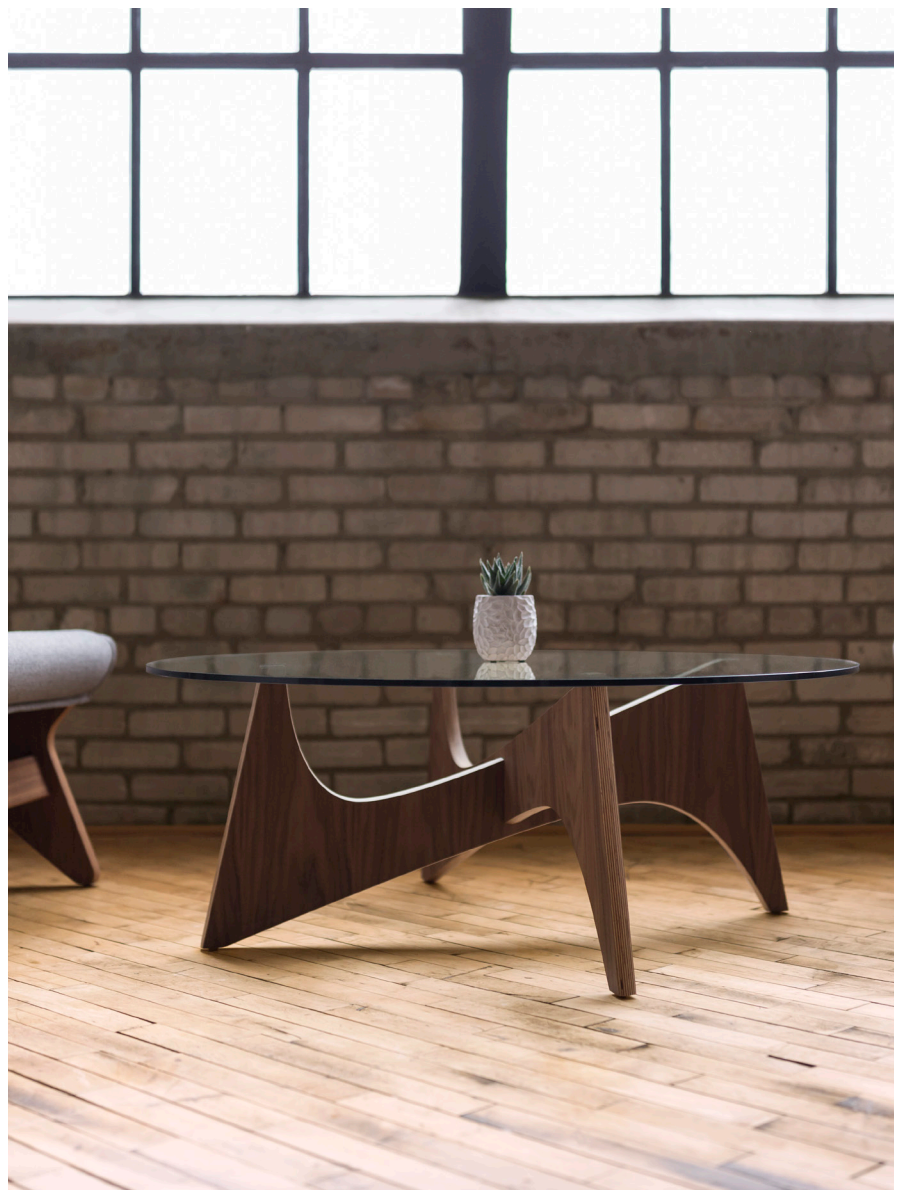

Cambre Table

Table of Contents	CA2
Specification Information	CA3
Specification Example	CA4
Table 16"	CA5
Table 22"	CA5

Table Model

DESCRIPTION	CODE
Cambre Table	CA

Table Height

DESCRIPTION	CODE
16"	16H
22"	22H

Base Finish

DESCRRIPTION	CODE
Natural Walnut	08M
Natural Ash	07M

Maple in Standard Leland Colors

LELAND COLORS

Top Size

DESCRRIPTION	CODE
16" H Table	
42" Round	42D
34" Square	3434
22" H Table	
18" Round	18D
16" Square	1616

Top Surface Option

DESCRRIPTION	CODE
16" H Table	
Clear Glass	G
22" H Table	
Clear Glass	G

Glide Selection

DESCRRIPTION	CODE
Nylon (standard)	S
Felt	F

Specifications required to create the product code

- Model
- Table Height
- Base Finish Selection
- Top Size
- Top Surface
- Glide Selection

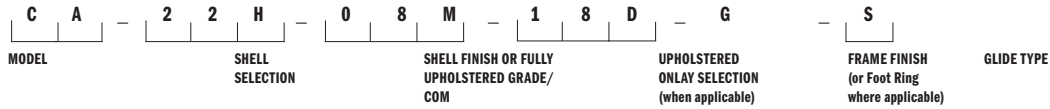

MODEL

Cambre Table (CA)

TABLE HEIGHT

22" (22H)

BASE FINISH

Natural Walnut (08M)

TOP SIZE

18" Round (18D)

TOP SURFACE

Glass (G)

GLIDE SELECTION

Nylon (S)



CAMBRE TABLE
Design: Bruce Sienkowski

CA5

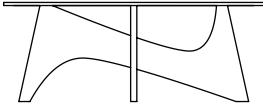

Cambre	MODEL	CLEAR GLASS
Cambre Occasional Table, 42" Round Top	CA-16H-42D	\$2351
W 42 D 42 H 16	Optional Glides: Add \$8.00 net per table for a set of four (4).	

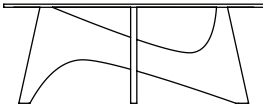

Cambre	MODEL	CLEAR GLASS
Cambre Occasional Table, 34" Square Top	CA-16H-3434	\$1859
W 34 D 34 H 16	Optional Glides: Add \$8.00 net per table for a set of four (4).	

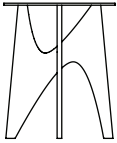

Cambre	MODEL	CLEAR GLASS
Cambre Side Table, 18" Round Top	CA-22H-18D	\$1874
W 18 D 18 H 22	Optional Glides: Add \$8.00 net per table for a set of four (4).	

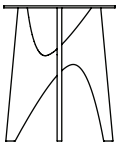

Cambre	MODEL	CLEAR GLASS
Cambre Side Table, 16" Square Top	CA-22H-1616	\$1477
W 16 D 16 H 22	Optional Glides: Add \$8.00 net per table for a set of four (4).	

To specify:
Please refer to pages 3-4 for complete specifying information. Specify all products by their product code.

**5695 Eagle Drive, SE
Grand Rapids,
Michigan 49512
616-975-9260
lelandfurniture.com**

Café Parfait

January 2024 Price List



Café Parfait

Table of Contents	CP2
Specification Information	CP3
Specification Example	CP4
Side Chair	CP5
Counter Chair	CP6
Bar Chair	CP7
Transport/Stacking Dolly	CP8

Chair Model

DESCRIPTION	CODE
Café Parfait side chair, upholstered seat, wood back	CPSUW
Café Parfait side chair, wood seat, wood back	CPSWW
Café Parfait counter chair, upholstered seat, wood back	CPCUW
Café Parfait counter chair, wood seat, wood back	CPCWW
Café Parfait bar chair, upholstered seat, wood back	CPBUW
Café Parfait bar chair, wood seat, wood back	CPBWW

Upholstery Selection**POLYPROPYLENE SHELL:**

Please refer to Leland Textile Program which features textiles and leathers from the following partners:

- Camira
- Green Hides
- Carnegie
- Maharam
- CF Stinson
- Unika Vaev

The complete grade list can be found on our website or you can specify COM/COL. Due to the design of this product, it is recommended that all non pre-approved textile be tested for compatibility.

Seat and Back Wood Finish**STANDARD LELAND COLORS**

CUSTOM Specify Custom (01)

*Please note that Café Parfait is NOT AVAILABLE in the following finishes:

Natural Walnut Matte (08M), Natural Beech (09), Natural White Oak Matte (12M)

Frame Finishes

DESCRIPTION	CODE
Sterling	ST
Warm Grey	WG
Cool Grey	CG
Black	B
White	W
Matte Mercury	MMR
Matte Mineral	MMN
Matte Burnish	MBN
Matte Foundry	MFN

TEXTURED

DESCRIPTION	CODE
Dolphin Textured	DLT
Oxford Textured	OXT
Black Textured	BT
White Textured	WT
Matte Blue Sky	MBS
Matte Forest	MFO
Matte Sienna	MSN
Matte Willow	MWL

Glide Type**STANDARD:**

DESCRIPTION	CODE
Nylon	S

OPTIONAL:

DESCRIPTION	CODE
Felt	FC
Floor Saver™ (for VCT type floors)	FS
Metal	M
Rubber	R

Please note that optional glides raise the chair height .5 inch.

Specifications required to create the product code

- Model
- Seat Upholstery or Finish
- Back Finish
- Frame Finish
- Glide Type



MODEL

Café Parfait Side Chair -
wood seat, wood back
(CPSWW)

SEAT UPHOLSTERY OR FINISH

Aegean (78)

BACK FINISH

Sea Grass (79)

FRAME FINISH

Sterling (ST)



CAFÉ PARFAIT SIDE CHAIR
 Design: Leland Design Group

CP5



Café Parfait Side Chair	MODEL	LIST PRICE
Wood seat wood back,	CPSWW	\$684

W 19 D 20 H 31 SH 19

Optional Glides: Add \$8.00 net per chair for a set of four (4). Optional Glides raise chair height .5 inch.



Café Parfait Side Chair	MODEL	LIST PRICE/GRADE	COM/COL	A	B	C	D	E	F	G	H	I	J	K	L
3D Beech veneer shell, upholstered seat onlay	CPSUW		\$637	670	689	706	724	741	761	778	797	814	832	849	868

W 19 D 20 H 31 SH 19

Optional Glides: Add \$8.00 net per chair for a set of four (4). Optional Glides raise chair height .5 inch.
 COM Yardage: 1 or 2 seats: .75 yard; 3 or 4 seats: 1.25 yards
 Contact Leland Customer Experience for yardage requirements on textiles with repeats.
 For COL requirements please contact Leland Customer Experience.

To specify:
 Please refer to pages 3-4 for
 complete specifying information.
 Specify all products by their
 product code.

Pricing Effective: January 2024

CAFÉ PARFAIT COUNTER CHAIR
 Design: Leland Design Group

CP6

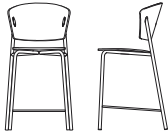

Café Parfait Counter Chair	MODEL	LIST PRICE
Wood seat wood back,	CPCWW	\$946

W 18.5 D 23 H 37.75 SH 25

Optional Glides: Add \$8.00 net per chair for a set of four (4). Optional Glides raise chair height .5 inch.

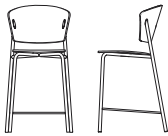

Café Parfait Counter Chair	MODEL	LIST PRICE/GRADE	COM/COL	A	B	C	D	E	F	G	H	I	J	K	L
3D Beech veneer shell, upholstered seat onlay	CPCUW		\$904	935	953	971	989	1007	1024	1043	1061	1079	1097	1115	1132

W 18.5 D 23 H 37.75
 SH 25.5

Optional Glides: Add \$8.00 net per chair for a set of four (4). Optional Glides raise chair height .5 inch.
 COM Yardage: 1 or 2 seats: .75 yard; 3 or 4 seats: 1.25 yards
 Contact Leland Customer Experience for yardage requirements on textiles with repeats.
 For COL requirements please contact Leland Customer Experience.

To specify:
 Please refer to pages 3-4 for
 complete specifying information.
 Specify all products by their
 product code.

Pricing Effective: January 2024

CAFÉ PARFAIT BAR CHAIR
 Design: Leland Design Group

CP7

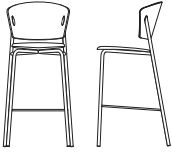

Café Parfait Bar Chair	MODEL	LIST PRICE
Wood seat wood back, W 19 D 20 H 43 SH 29.5	CPBWW	\$967

Optional Glides: Add \$8.00 net per chair for a set of four (4). Optional Glides raise chair height .5 inch.

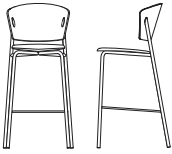

Café Parfait Bar Chair	MODEL	LIST PRICE/GRADE	COM/COL	A	B	C	D	E	F	G	H	I	J	K	L
3D Beech veneer shell, upholstered seat onlay W 19 D 20 H 43 SH 30	CPBUW		\$921	953	971	989	1007	1024	1043	1061	1079	1097	1115	1132	1150

Optional Glides: Add \$8.00 net per chair for a set of four (4). Optional Glides raise chair height .5 inch.
 COM Yardage: 1 or 2 seats: .75 yard; 3 or 4 seats: 1.25 yards
 Contact Leland Customer Experience for yardage requirements on textiles with repeats.
 For COL requirements please contact Leland Customer Experience.

To specify:
 Please refer to pages 3-4 for complete specifying information.
 Specify all products by their product code.

Pricing Effective: January 2024

CAFÉ PARFAIT TRANSPORT/STACKING DOLLY
Design: Leland Design Group

CP8

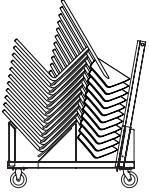

**Café Parfait Transport/
Stacking Dolly**

MODEL

LIST PRICE

W 19 D 43 H 45 (Empty)

CPD

Black Finish

\$1088

W 19 D 43 H 67
(With 10 side chairs)

Café Parfait Transport/Stacking Dolly handles up to 10 Café Parfait side chairs.

To specify:

Please refer to pages 3-4 for
complete specifying information.

Specify all products by their
product code.

Pricing Effective: January 2024

**5695 Eagle Drive, SE
Grand Rapids,
Michigan 49512
616-975-9260
lelandfurniture.com**

Ease

January 2024 Price List



Ease

Table of Contents	ES2
Specification Information	ES3
Specification Example	ES4
Side Chair	ES5
Transport/Stacking Dolly	ES7

Chair Model

DESCRIPTION	CODE
Ease side chair, upholstered seat, wood back	ESSUW
Ease side chair ganging, upholstered seat , wood back	ESSGUW
Ease side chair, upholstered seat, wood back upholstered back onlay	ESSUWU
Ease side chair ganging, upholstered seat wood back, upholstered back onlay	ESSGUWU
Ease side chair, wood seat, wood back	ESSWW
Ease side chair ganging, wood seat wood back	ESSGWW

Seat and Back Wood Finish**STANDARD LELAND COLORS****CUSTOM** Specify Custom (01)

*Please note that Ease is NOT AVAILABLE in the following finishes:

Upholstery Selection

Please refer to Leland Textile Program which features textiles and leathers from the following partners:

- Camira
- Carnegie
- CF Stinson
- Green Hides
- Maharam
- Unika Vaev

The complete grade list can be found on our website or you can specify COM/COL. Due to the design of this product, it is recommended that all non pre-approved textile be tested for compatibility.

Frame Finish: Powdercoat and Chrome

DESCRIPTION	CODE
Sterling	ST
Warm Grey	WG
Cool Grey	CG
Black	B
White	W
Matte Mercury	MMR
Matte Mineral	MMN
Matte Burnish	MBN
Matte Foundry	MFN
Chrome	C
Matte Blue Sky	MBS
Matte Forest	MFO
Matte Sienna	MSN
Matte Willow	MWL
TEXTURED	CODE
Dolphin Textured	DLT
Oxford Textured	OXT
Black Textured	BT
White Textured	WT

Auxiliary Options**GLIDES**

DESCRIPTION	CODE
Polycarbonate	P
Felt	F

Please note that adding glides raises the chair height.25 inch.

Specifications required to create the product code

- Model
- Seat Upholstery or Finish
- Back Finish
- Upholstered Back Onlay (when applicable)
- Frame Finish
- Auxiliary Options (when applicable)



MODEL

Ease Side Chair, upholstered seat, wood back, upholstered back onlay (ESSUWU)

SEAT UPHOLSTERY OR FINISH

Grade H (H)

BACK FINISH

Natural (11)

UPHOLSTERED BACK ONLAY

Grade H (H)

FRAME FINISH

Chrome (C)



EASE SIDE CHAIR
Design: Leland Design Group

ES5



Ease Side Chair

	MODEL	LIST PRICE/GRADE	COM/COL	A	B	C	D	E	F	G	H	I	J	K	L
Upholstered seat, wood back	ESSUW		\$613	646	664	680	698	714	732	749	765	782	800	816	834
W 19.5 D 21.75 H 31 SH 18.5															

Glides: Add \$8.00 net per chair for a set of four (4).
COM Yardage: 1 or 2 seats: .75 yard, 3 or 4 seats: 1.5 yards, 5 or 6 seats: 2.25 yards.
Contact Leland Customer Experience for yardage requirements on textiles with repeats.
For COL requirements please contact Leland Customer Experience.



Ease Side Chair, Ganging

	MODEL	LIST PRICE/GRADE	COM/COL	A	B	C	D	E	F	G	H	I	J	K	L
Upholstered seat, wood back	ESSGUW		\$664	696	713	731	747	764	781	799	815	832	849	866	883
W 19.5 D 21.75 H 31 SH 18.5															

Glides: Add \$8.00 net per chair for a set of four (4).
COM Yardage: 1 or 2 seats: .75 yard, 3 or 4 seats: 1.5 yards, 5 or 6 seats: 2.25 yards.
Contact Leland Customer Experience for yardage requirements on textiles with repeats.
For COL requirements please contact Leland Customer Experience.



Ease Side Chair

	MODEL	LIST PRICE/GRADE	COM/COL	A	B	C	D	E	F	G	H	I	J	K	L
Upholstered seat, wood back upholstered back onlay	ESSUWU		\$650	683	700	716	734	751	769	784	802	819	836	852	871
W 19.5 D 21.75 H 31 SH 18.5															

Glides: Add \$8.00 net per chair for a set of four (4).
COM Yardage: 1 seat and back: .75 yard, 6 seats and backs: 3.5 yards
Contact Leland Customer Experience for yardage requirements on textiles with repeats.
For COL requirements please contact Leland Customer Experience.



Ease Side Chair, Ganging

	MODEL	LIST PRICE/GRADE	COM/COL	A	B	C	D	E	F	G	H	I	J	K	L
Upholstered seat, wood back upholstered back onlay	ESSGUWU		\$771	803	820	837	855	872	889	906	923	940	956	974	991
W 19.5 D 21.75 H 31 SH 18.5															

Glides: Add \$8.00 net per chair for a set of four (4).
COM Yardage: 1 seat and back: .75 yard, 6 seats and backs: 3.5 yards
Contact Leland Customer Experience for yardage requirements on textiles with repeats.
For COL requirements please contact Leland Customer Experience.

To specify:
Please refer to pages 3-4 for complete specifying information.
Specify all products by their product code.

Pricing Effective: January 2024

EASE SIDE CHAIR
Design: Leland Design Group

ES6

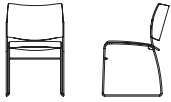

Ease Side Chair	MODEL	LIST PRICE
Wood seat wood back,	ESSWW	\$630
W 19.5 D 21.75 H 31 SH 18	Glides: Add \$8.00 net per chair for a set of four (4).	



Ease Side Chair, Ganging	MODEL	LIST PRICE
Wood seat wood back,	ESSGWW	\$664
W 19.5 D 21.75 H 31 SH 18	Glides: Add \$8.00 net per chair for a set of four (4).	

To specify:
Please refer to pages 3-4 for
complete specifying information.
Specify all products by their
product code.

Pricing Effective: January 2024

EASE TRANSPORT/STACKING DOLLY
Design: Leland Design Group

ES7

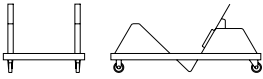

**Ease Transport/
Stacking Dolly**

MODEL

LIST PRICE

W 22.75 D 46.5 H 14.25
(empty)

ESSNDB

\$1087

Ease Transport/Stacking Dolly handles up to 25 side chairs in wood or 15 side chairs upholstered.

To specify:

**Please refer to pages 3-4 for
complete specifying information.
Specify all products by their
product code.**

Pricing Effective: January 2024

**5695 Eagle Drive, SE
Grand Rapids,
Michigan 49512
616-975-9260
lelandfurniture.com**

Ebb Bench Fully Upholstered

January 2024 Price List



Ebb Fully Upholstered

Table of Contents	EB2
Specification Information	EB3
Specification Example	EB4
Two Closed Ends	EB5
One Linking End	EB6
Two Linking Ends	EB7
Auxiliary Options	EB8
Hub Specification Information	EB9
Hub Specification Example	EB10
Hub	EB11
Hub Auxiliary Options	EB12
Pod Specification Information	EB13
Pod Specification Example	EB14
Pod	EB15
Pod Auxiliary Options	EB16

Bench Model

DESCRIPTION	CODE
Ebb fully upholstered bench, two closed ends	EBFUCC
Ebb fully upholstered bench, one linking end	EBFUCL
Ebb fully upholstered bench, two linking ends	EBFULL

Bench Length

DESCRIPTION	CODE
30" Long	30
48" Long	48
72" Long	72
96" Long	96
120" Long	120

Fully Upholstered Selection

Please refer to Leland Textile Program which features textiles and leathers from the following partners:

- Camira
- Carnegie
- CF Stinson
- Green Hides
- Maharam
- Unika Vaev

The complete grade list can be found at www.lelandfurniture.com/resources or you can specify COM/COL. All non pre-approved textiles need be tested for compatibility.

Due to upholstery requirements, the Ebb product line can only be upholstered railroaded. Please consider when specifying textiles with a pattern. Untested COM or COL textiles will not be accepted.

Leg Finish

Ebb fully upholstered linking benches have black powder coat skirts.

DESCRIPTION	CODE
Sterling	ST
Warm Grey	WG
Cool Grey	CG
Black	B
White	W
Matte Mercury	MMR
Matte Mineral	MMN
Matte Burnish	MBN
Matte Foundry	MFN
Black Textured	BT
White Textured	WT
Chrome	C

Auxiliary Options

Auxiliary Options must be specified at the time of the order.

SKIRT:

DESCRIPTION	CODE
Ebb Fully Upholstered Bench Skirt	SK

FLOOR MOUNT:

DESCRIPTION	CODE
Ebb Fully Upholstered Bench Floor Mount	FM

*Floor Mount requires Skirt.

Glides

Ebb glides are nylon

Product Specification

Ebb layout is required at the quotation stage and order stage to ensure accurate product specifications. Contact Leland Customer Experience for CAD drawings.

Specifications required to create the product code

- Model
- Bench Length
- Upholstery Selection
- Leg Finish
- Skirt (when applicable)
- Floor Mount (when applicable)



MODEL

Ebb Fully Upholstered Bench
Two Closed Ends (EBFUCC)

BENCH LENGTH

72" (72)

UPHOLSTERY SELECTION

Enter upholstery grade,
COM or COL (COM)

LEG FINISH

Specify Standard Powder Coat

SKIRT

When Applicable, enter skirt code

FLOOR MOUNT

When Applicable, enter Ebb floor
mount code. Floor Mount requires Skirt.



EBB FULLY UPHOLSTERED BENCH TWO CLOSED ENDS

Design: Mark Gabbartas

EB5

Ebb Fully Upholstered Bench Two Closed Ends Skirt must be specified at the time of ordering. Skirt cannot be added later in the field.



Ebb Fully Upholstered Bench

Two Closed Ends

	MODEL	LIST PRICE/GRADE	COM/COL	A	B	C	D	E	F	G	H	I	J	K	L
30" long	EBFUCC-30		\$2460	2676	2828	2986	3149	3313	3486	3662	3843	4030	4225	4424	4628

W 17.5 L 18.5

COM Yardage: 1.75 yards
For COL requirements please contact Leland Customer Care.



Ebb Fully Upholstered Bench

Two Closed Ends

	MODEL	LIST PRICE/GRADE	COM/COL	A	B	C	D	E	F	G	H	I	J	K	L
48" long	EBFUCC-48		\$3241	3545	3754	3970	4192	4420	4656	4899	5149	5407	5673	5948	6229

W 17.5 L 18.5

COM Yardage: 2.75 yards
For COL requirements please contact Leland Customer Care.

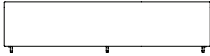

Ebb Fully Upholstered Bench

Two Closed Ends

	MODEL	LIST PRICE/GRADE	COM/COL	A	B	C	D	E	F	G	H	I	J	K	L
72" long	EBFUCC-72		\$4022	4400	4659	4929	5206	5489	5784	6086	6397	6718	7049	7388	7738

W 17.5 L 18.5

COM Yardage: 4.25 yards
For COL requirements please contact Leland Customer Care.



Ebb Fully Upholstered Bench

Two Closed Ends

	MODEL	LIST PRICE/GRADE	COM/COL	A	B	C	D	E	F	G	H	I	J	K	L
96" long	EBFUCC-96		\$4800	5280	5607	5944	6290	6647	7015	7395	7784	8185	8600	9025	9465

W 17.5 L 18.5

COM Yardage: 5.5 yards
For COL requirements please contact Leland Customer Care.



Ebb Fully Upholstered Bench

Two Closed Ends

	MODEL	LIST PRICE/GRADE	COM/COL	A	B	C	D	E	F	G	H	I	J	K	L
120" long	EBFUCC-120		\$5581	6159	6548	6951	7364	7789	8228	8680	9145	9625	10119	10628	11150

W 17.5 L 18.5

COM Yardage: 7 yards
For COL requirements please contact Leland Customer Care.

To specify:

Please refer to pages 3-4 for complete specifying information. Specify all products by their product code.

Pricing Effective: January 2024

EBB FULLY UPHOLSTERED BENCH ONE LINKING END
 Design: Mark Gabbartas

EB6



**Ebb Fully Upholstered Bench
 One Linking End**

	MODEL	LIST PRICE/GRADE	COM/COL	A	B	C	D	E	F	G	H	I	J	K	L
30" long	EBFUCL-30		\$2504	2721	2875	3033	3197	3364	3539	3716	3900	4088	4284	4484	4691

W 17.5 L 18.5

COM Yardage: 1.75 yards
 For COL requirements please contact Leland Customer Care.
 Unit comes with skirt.



**Ebb Fully Upholstered Bench
 One Linking End**

	MODEL	LIST PRICE/GRADE	COM/COL	A	B	C	D	E	F	G	H	I	J	K	L
48" long	EBFUCL-48		\$3284	3590	3801	4017	4241	4472	4709	4954	5206	5465	5733	6007	6291

W 17.5 L 18.5

COM Yardage: 2.75 yards
 For COL requirements please contact Leland Customer Care.
 Unit comes with skirt.



**Ebb Fully Upholstered Bench
 One Linking End**

	MODEL	LIST PRICE/GRADE	COM/COL	A	B	C	D	E	F	G	H	I	J	K	L
72" long	EBFUCL-72		\$4063	4444	4706	4975	5253	5540	5833	6138	6450	6773	7104	7446	7800

W 17.5 L 18.5

COM Yardage: 4.25 yards
 For COL requirements please contact Leland Customer Care.
 Unit comes with skirt.

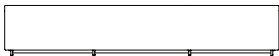

**Ebb Fully Upholstered Bench
 One Linking End**

	MODEL	LIST PRICE/GRADE	COM/COL	A	B	C	D	E	F	G	H	I	J	K	L
96" long	EBFUCL-96		\$4843	5324	5651	5989	6338	6697	7065	7445	7838	8239	8657	9083	9525

W 17.5 L 18.5

COM Yardage: 5.5 yards
 For COL requirements please contact Leland Customer Care.
 Unit comes with skirt.

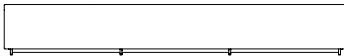

**Ebb Fully Upholstered Bench
 One Linking End**

	MODEL	LIST PRICE/GRADE	COM/COL	A	B	C	D	E	F	G	H	I	J	K	L
120" long	EBFUCL-120		\$5623	6200	6589	6989	7401	7824	8262	8711	9176	9653	10145	10652	11172

W 17.5 L 18.5

COM Yardage: 7 yards
 For COL requirements please contact Leland Customer Care.
 Unit comes with skirt.

To specify:
 Please refer to pages 3-4 for
 complete specifying information.
 Specify all products by their
 product code.

EBB FULLY UPHOLSTERED BENCH TWO LINKING ENDS
 Design: Mark Gabbartas

EB7



**Ebb Fully Upholstered Bench
 Two Linking Ends**

	MODEL	LIST PRICE/GRADE	COM/COL	A	B	C	D	E	F	G	H	I	J	K	L
30" long	EBFULL-30		\$2545	2765	2918	3079	3243	3412	3586	3767	3952	4142	4339	4541	4750

W 17.5 L 18.5

COM Yardage: 1.75 yards
 For COL requirements please contact Leland Customer Care.
 Unit comes with skirt.



**Ebb Fully Upholstered Bench
 Two Linking Ends**

	MODEL	LIST PRICE/GRADE	COM/COL	A	B	C	D	E	F	G	H	I	J	K	L
48" long	EBFULL-48		\$3323	3630	3842	4061	4286	4518	4757	5003	5256	5517	5785	6062	6347

W 17.5 L 18.5

COM Yardage: 2.75 yards
 For COL requirements please contact Leland Customer Care.
 Unit comes with skirt.



**Ebb Fully Upholstered Bench
 Two Linking Ends**

	MODEL	LIST PRICE/GRADE	COM/COL	A	B	C	D	E	F	G	H	I	J	K	L
72" long	EBFULL-72		\$4109	4488	4752	5022	5302	5591	5887	6193	6505	6830	7164	7508	7862

W 17.5 L 18.5

COM Yardage: 4.25 yards
 For COL requirements please contact Leland Customer Care.
 Unit comes with skirt.



**Ebb Fully Upholstered Bench
 Two Linking Ends**

	MODEL	LIST PRICE/GRADE	COM/COL	A	B	C	D	E	F	G	H	I	J	K	L
96" long	EBFULL-96		\$4887	5368	5697	6036	6385	6745	7116	7497	7892	8296	8714	9143	9586

W 17.5 L 18.5

COM Yardage: 5.5 yards
 For COL requirements please contact Leland Customer Care.
 Unit comes with skirt.

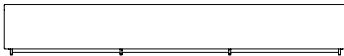

**Ebb Fully Upholstered Bench
 Two Linking Ends**

	MODEL	LIST PRICE/GRADE	COM/COL	A	B	C	D	E	F	G	H	I	J	K	L
120" long	EBFULL-120		\$5668	6245	6639	7043	7458	7888	8329	8784	9253	9735	10233	10744	11273

W 17.5 L 18.5

COM Yardage: 7 yards
 For COL requirements please contact Leland Customer Care.
 Unit comes with skirt.

To specify:
 Please refer to pages 3-4 for complete specifying information.
 Specify all products by their product code.

EBB FULLY UPHOLSTERED BENCH AUXILIARY OPTIONS

Design: Mark Gabbartas

EB8

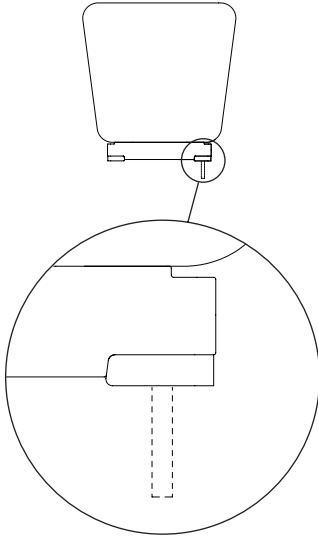

**Ebb Fully Upholstered Bench
Floor Mount**

MODEL

LIST PRICE

FM

\$273

Due to the variety of floor surfaces on which Ebb products may be installed, floor mount fasteners are not supplied by Leland International. The Ebb product floor mount option consists of feet with floor mount brackets designed to use .5" thread diameter fasteners. Responsibility of fastener choice is the customers.

Floor Mount requires a skirt and both must be specified at the time of ordering. The Floor Mount cannot be added later in the field.



**Ebb Fully Upholstered Bench
Two Closed Ends Skirt**

MODEL

LIST PRICE

Black Powdercoat Finish

SK

\$171

Ebb Fully Upholstered Bench Two Closed Ends Skirt must be specified at the time of ordering. Skirt cannot be added later in the field. Linking Ebb Benches come standard with skirts..

To specify:

Please refer to pages 3-4 for complete specifying information.

Specify all products by their product code.

Pricing Effective: January 2024

Hub Model

DESCRIPTION	CODE
Ebb Hub, upholstered, one linking end	EBH1L
Ebb Hub, upholstered, two linking ends, 240 degrees	EBH2L
Ebb Hub, upholstered, two linking ends, 180 degrees	EBH3L
Ebb Hub, upholstered, three linking ends	EBH4L

Upholstery Selection

Please refer to Leland Textile Program which features textiles and leathers from the following partners:

- Camira
- Carnegie
- CF Stinson
- Green Hides
- Maharam
- Unika Vaev

The complete grade list can be found at www.lelandfurniture.com/resources or you can specify COM/COL. All non pre-approved textiles need to be tested for compatibility.

Due to upholstery requirements, the Ebb product line can only be upholstered railroaded. Please consider when specifying textiles with a pattern. Untested COM or COL textiles will not be accepted.

Powder Coat Frame Finishes

Ebb Fully Upholstered Hubs have black powder coat skirts.

DESCRIPTION	CODE
Sterling	ST
Warm Grey	WG
Cool Grey	CG
Black	B
White	W
Matte Gold Rush	MGR
Matte Mercury	MMR
Matte Mineral	MMN
Matte Burnish	MBN
Matte Foundry	MFN
Black Textured	BT
Grey Textured	GT
White Textured	WT
Chrome	C

Auxiliary Options

Auxiliary Options must be specified at the time of the order.

DESCRIPTION	CODE
Ebb Fully Upholstered Hub Floor Mount	FM

Glides

Ebb glides are nylon.

Product Specification

Ebb layout is required at the quotation stage and order stage to ensure accurate product specifications. Contact Leland Customer Care for CAD drawings.

Specifications required to create the product code

- Model
- Model
- Upholstery Selection
- Leg Finish
- Floor Mount (when applicable)



MODEL

Ebb Fully Upholstered Hub -
One Linking End (EBH1L)

UPHOLSTERY SELECTION

Enter upholstery grade,
COM or COL. Grade J (J)

LEG FINISH

Specify Standard Powder Coat

FLOOR MOUNT

When Applicable, enter Ebb
floor mount code



EBB FULLY UPHOLSTERED HUB
Design: Mark Gabbartas

EB11

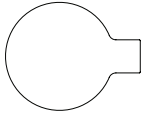

Ebb Fully Upholstered Hub

MODEL	LIST PRICE/GRADE	COM/COL	A	B	C	D	E	F	G	H	I	J	K	L
EBH1L	\$7841		8688	9253	9837	10436	11055	11694	12349	13026	13721	14439	15179	15939

One linking end

DIA 60 EXT 15

COM Yardage: 5.25 yards
For COL requirements please contact Leland Customer Care.
Unit comes with skirt.

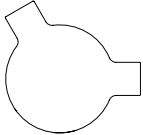

Ebb Fully Upholstered Hub

MODEL	LIST PRICE/ GRADE	COM/COL	A	B	C	D	E	F	G	H	I	J	K	L
EBH2L	\$8258		9222	9857	10511	11183	11876	12591	13327	14085	14864	15669	16497	17350

Two linking ends, 240 degrees

DIA 60 EXT 15

COM Yardage: 5.75 yards
For COL requirements please contact Leland Customer Care.
Unit comes with skirt.

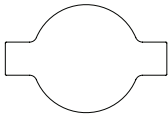

Ebb Fully Upholstered Hub

MODEL	LIST PRICE/ GRADE	COM/COL	A	B	C	D	E	F	G	H	I	J	K	L
EBH3L	\$8258		9222	9857	10511	11183	11876	12591	13327	14085	14864	15669	16497	17350

Two linking ends, 180 degrees

DIA 60 EXT 15

COM Yardage: 7 yards
For COL requirements please contact Leland Customer Care.
Unit comes with skirt.

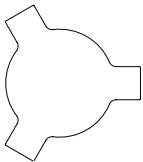

Ebb Fully Upholstered Hub

MODEL	LIST PRICE/ GRADE	COM/COL	A	B	C	D	E	F	G	H	I	J	K	L
EBH4L	\$8675		9749	10450	11171	11915	12679	13467	14279	15114	15974	16862	17774	18716

Three linking ends

DIA 60 EXT 15

COM Yardage: 8 yards
For COL requirements please contact Leland Customer Care.
Unit comes with skirt.

To specify:
Please refer to pages 9-10 for complete specifying information.
Specify all products by their product code.

Pricing Effective: January 2024

EBB FULLY UPHOLSTERED HUB AUXILIARY OPTIONS

Design: Mark Gabbartas

EB12

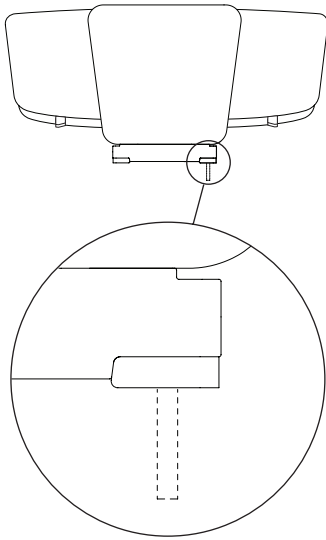

**Ebb Fully Upholstered Hub
Floor Mount**

MODEL

LIST PRICE

FM

\$273

Due to the variety of floor surfaces on which Ebb products may be installed, floor mount fasteners are not supplied by Leland International. The Ebb product floor mount option consists of feet with floor mount brackets designed to use 1/2" thread diameter fasteners. Responsibility of fastener choice is the customers.

Floor Mount must be specified at the time of ordering.

The Floor Mount cannot be added later in the field.

To specify:

Please refer to pages 9-10 for complete specifying information.

Specify all products by their product code.

Pricing Effective: January 2024

Pod Model

DESCRIPTION	CODE
Ebb Fully Upholstered Pod	EBH5

Upholstery Selection

Please refer to Leland Textile Program which features textiles and leathers from the following partners:

- Camira
- Green Hides
- Carnegie
- Maharam
- CF Stinson
- Unika Vaev

The complete grade list can be found at www.lelandfurniture.com/resources or you can specify COM/COL.

Due to upholstery requirements, the Ebb product line can only be upholstered railroaded. Please consider when specifying textiles with a pattern. Untested COM or COL textiles will not be accepted.

Leg Finish

DESCRIPTION	CODE
Sterling	ST
Warm Grey	WG
Cool Grey	CG
Black	B
White	W
Matte Gold Rush	MGR
Matte Mercury	MMR
Matte Mineral	MMN
Matte Burnish	MBN
Matte Foundry	MFN
Black Textured	BT
Grey Textured	GT
White Textured	WT
Chrome	C

Auxiliary Options

Auxiliary Options must be specified at the time of the order.

SKIRT:

DESCRIPTION	CODE
Ebb Fully Upholstered Pod Skirt	SK

FLOOR MAT:

DESCRIPTION	CODE
Ebb Fully Upholstered Pod Floor Mount	FM
Floor Mount requires Skirt.	

Glides

Ebb glides are nylon.

Product Specification

Ebb layout is required at the quotation stage and order stage to ensure accurate product specifications. Contact Leland Customer Experience for CAD drawings.

Specifications required to create the product code

- Model
- Upholstery Selection
- Leg Finish
- Skirt (when applicable)
- Floor Mount (when applicable)



MODEL

Ebb Fully Upholstered Pod (EBH5)

UPHOLSTERY SELECTION

Enter upholstery grade, COM or COL. Grade J (J)

LEG FINISH

Specify Standard Powder Coat

SKIRT

Skirt (SK)

FLOOR MOUNT

When applicable, enter Ebb floor mount code. Floor Mount requires Skirt.



EBB FULLY UPHOLSTERED POD
Design: Mark Gabbartas

EB15

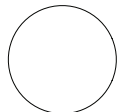

Ebb Fully Upholstered Pod

	MODEL	LIST PRICE/GRADE	COM/COL	A	B	C	D	E	F	G	H	I	J	K	L
No linking end	EBH5		\$7252	8081	8632	9196	9779	10379	10997	11634	12290	12967	13662	14379	15117

DIA 54 SH 18.5

COM Yardage: 6 yards
For COL requirements please contact Leland Customer Care.

To specify:
Please refer to pages 13-14 for complete specifying information.
Specify all products by their product code.

Pricing Effective: January 2024

EBB FULLY UPHOLSTERED POD AUXILIARY OPTIONS

Design: Mark Gabbartas

EB16

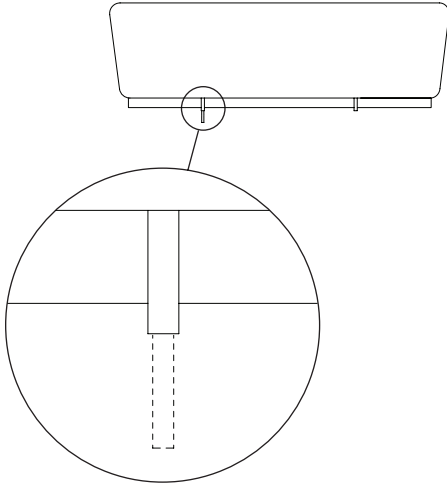

**Ebb Fully Upholstered Pod
Floor Mount**

	MODEL	LIST PRICE
	FM	\$273

Due to the variety of floor surfaces on which Ebb products may be installed, floor mount fasteners are not supplied by Leland International. The Ebb product floor mount option consists of feet with floor mount brackets designed to use .5" thread diameter fasteners. Responsibility of fastener choice is the customers.

Floor Mount requires a skirt and both must be specified at the time of ordering. The Floor Mount cannot be added later in the field.



**Ebb Fully Upholstered Pod
Skirt**

	MODEL	LIST PRICE
Black Powdercoat Finish	SK	\$171

Ebb Fully Upholstered Bench Two Closed Ends Skirt must be specified at the time of ordering. Skirt cannot be added later in the field.

To specify:
Please refer to pages 13-14 for complete specifying information.
Specify all products by their product code.

Pricing Effective: January 2024

**5695 Eagle Drive, SE
Grand Rapids,
Michigan 49512
616-975-9260
lelandfurniture.com**













Fast Table

January 2024 Price List



Fast Table

Table of Contents	FT2
Visual Reference	FT3
Table Top Specification Information	FT4
Table Top Specification Example	FT5
Table Tops	FT6
Table Base Specification Information	FT7
Table Base Specification Example	FT8
Table Bases	FT9
Modesty Panel Specification Information	FT10
Modesty Panel Specification Example	FT11
Modesty Panel	FT12
Transport Trolley Specification Information	FT13
Transport Trolley Specification Example	FT14
Transport Trolley	FT15

TABLE MODEL	TABLE TOP SIZES			BASE	PAGE
Size A 	Round  48 DIA 54 DIA	Square  42 x 42	Rectangle  24 x 48 30 x 48	Powdercoat	Top: Page 6 Base: Page 9
Size B 	Round  60 DIA	Square  48 x 48	Rectangle  24 x 60 30 x 60	Powdercoat	Top: Page 6 Base: Page 9
Size C 	Round  72 DIA	Square  54 x 54	Rectangle  24 x 72 30 x 72	Powdercoat	Top: Page 6 Base: Page 9

To specify:
 Please refer to pages 3-4 for complete specifying information.
 Specify all products by their product code.

Due to the design intent of Fast, table tops and table bases are sold separately. This page is for specifying the table top only.

Table Top Model

ROUND	FITS BASE	CODE
48 DIA	A	F48A
54 DIA	A	F54A
60 DIA	B	F60B
72 DIA	C	F72C
SQUARE		
42x42	A	F4242A
48x48	B	F4848B
54x54	C	F5454C
RECTANGLE		
24x48	A	F2448A
30x48	A	F3048A
24x60	B	F2460B
30x60	B	F3060B
24x72	C	F2472C
30x72	C	F3072C

Top Surface

LAMINATE TOPS:

DESCRIPTION	CODE
Identify manufacturer, laminate code, & color	L

Please refer to the Leland Terms and Conditions Guide for a listing of standard laminates. For table pricing in laminates not listed, please contact Leland's Customer Experience Department for a quotation.

Edge Type

V7 VINYL EDGE:

.75" 3mm PVC



Edge Color

V7 VINYL EDGE COLORS:

DESCRIPTION	CODE
Black	B
Grey	G
Pewter	PW
Saddle	SL
Stone	SN
Truffle	TF
White	W
Bluestone	BST
Indian Smoke	ISM
Nubian Brown	NBR
Amazon	AMZ
Taupe	TPE

Attachment Color

DESCRIPTION	CODE
Black	B

Auxiliary Options

DESCRIPTION	CODE
Ganging Device (two per set)	GD

Product Weights

BASES	LBS
FBA	15
FBB	20
FBC	25

ROUND	FITS BASE	LBS
48 DIA	A	50
54 DIA	A	60
60 DIA	B	65
72 DIA	C	75

SQUARE	FITS BASE	LBS
42x42	A	50
48x48	B	60
54x54	C	70

RECTANGLE	FITS BASE	LBS
24x48	A	30
30x48	A	40
24x60	B	35
30x60	B	45
24x72	C	45
30x72	C	55

Specifications required to create the product code

- Model
- Top Surface
- Edge Color
- Attachment Color
- Auxiliary Options (when applicable)



MODEL

Fast 30 x 60 Rectangle Table Top (F3060B)

TOP SURFACE

Laminate (L)

EDGE COLOR

Grey (G)

ATTACHMENT COLOR

Black (B)

AUXILIARY OPTIONS









When applicable



FAST TABLE TOPS

Design: Carlos Tíscar, licensed by Sellex

FT6

Fast Table Top	MODEL	FRAME FINISH	LIST PRICE
Laminate Top			
Top sizes for base A	F48A	48 DIA	\$1396
  	F54A	54 DIA	\$1423
Round	F60B	60 DIA	\$1452
48 DIA	F72C	72 DIA	\$3866
54 DIA	F4242A	42x42	\$1073
	F4848B	48x48	\$1104
Top sizes for base B	F5454C	54x54	\$1587
  	F2448A	24x48	\$597
Round	F3048A	30x48	\$704
60 DIA	F2460B	24x60	\$734
	F3060B	30x60	\$849
Top sizes for base C	F2472C	24x72	\$830
  	F3072C	30x72	\$992
Square			
72 DIA			

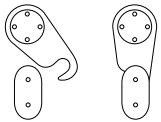

Ganging Device	MODEL	LIST PRICE
two per set	GD	\$196

To specify:
Please refer to pages 3-4 for complete specifying information.
Specify all products by their product code.

Pricing Effective: January 2024

Due to the design intent of Fast, table tops and table bases are sold separately. This page is for specifying the table bases only.

Table Base Model

DESCRIPTION	CODE
Base A (fits 48 Dia, 54 Dia, 42x42, 24x48 and 30x48)	FBA
Base B (fits 60 Dia, 48x48, 24x60 and 30x60)	FBB
Base C (fits 72 Dia, 54x54, 24x72 and 30x72)	FBC

Base Finish

DESCRIPTION	CODE
Sterling	ST
Dolphin Textured	DLT
Oxford Textured	OXT
Black Textured	BT
White Textured	WT
Matte Mercury	MMR
Matte Mineral	MMN
Matte Burnish	MBN
Matte Foundry	MFN
Matte Blue Sky	MBS
Matte Forest	MFO
Matte Sienna	MSN
Matte Willow	MWL
Matte Fawn	MFW
Matte Pistachio	MPS
Matte Fog	MFG
Matte Pine	MPN
Matte Seafoam	MSF
Matte Dijon	MDJ

Glide and Attachment Color

DESCRIPTION	CODE
Black	B

Freight Note

Due to the size and nature of Fast Tables, the Freight Program does not apply to this product. Please contact Customer Experience for a quote.

Specifications required to create the product code

- Model
- Base Finish
- Glide and Attachment Color

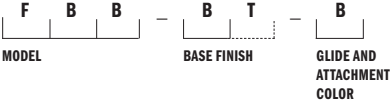

MODEL

Fast Size B Table Base (FBB)

BASE FINISH

Black Textured (BT)

GLIDE AND ATTACHMENT COLOR

Black (B)



FAST TABLE BASES

Design: Carlos Tíscar, licensed by Sellex

FT9



Base Size A	MODEL	LIST PRICE
W 46.7 H 27.4	FBA	\$1341

Fits Top Sizes:



Round	Square	Rectangle
48 DIA	42 x 42	24 x 48
54 DIA		30 x 48

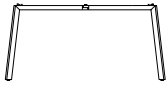

Base Size B	MODEL	LIST PRICE
W 57.8 H 27.4	FBB	\$1367

Fits Top Sizes:



Round	Square	Rectangle
60 DIA	48 x 48	24 x 60
		30 x 60

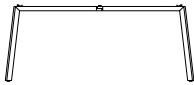

Base Size C	MODEL	LIST PRICE
W 68 H 27.4	FBC	\$1396

Fits Top Sizes:



Round	Square	Rectangle
72 DIA	54 x 54	24 x 72
		30 x 72

To specify:

Please refer to table bases on pages 4-5 and table tops on pages 7-8 for complete specifying information.

Specify all products by their product code.

Model

DESCRIPTION	FITS BASE	CODE
Modesty panel for 24x48 table	A	FM2448
Modesty panel for 30x48 table	A	FM3048
Modesty panel for 24x60 table	B	FM2460
Modesty panel for 30x60 table	B	FM3060
Modesty panel for 24x72 table	C	FM2472
Modesty panel for 30x72 table	C	FM3072

Modesty Panel Cover

DESCRIPTION	CODE
Grey	G

Optional Modesty Panel Cover (Orders of 20+ Units)

DESCRIPTION	CODE
Black	B
White	W

Specifications required to create the product code

- Model
- Modesty Panel Color

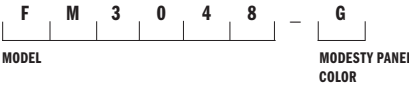

MODEL

Fast Modesty Panel for 30 x 48 Table (FM3048)

MODESTY PANEL COVER

Grey (G)



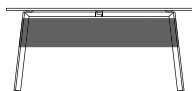

Modesty Panel	MODEL	SIZE	LIST PRICE
		Base A	
	FM2448	24x48	\$294
	FM3048	30x48	\$294
		Base B	
	FM2460	24x60	\$308
	FM3060	30x60	\$308
		Base C	
	FM2472	24x72	\$326
	FM3072	30x72	\$326

To specify:
 Please refer to table bases on pages 4-5, table tops on pages 7-8 and modesty panels on pages 10-11 for complete specifying information. Specify all products by their product code.

Model

DESCRIPTION	CODE
Fast Transport Trolley	FTT

Specifications required to create the product code

Model



MODEL

Fast Transport Trolley (FTT)



FAST TRANSPORT TROLLEY
 Design: Carlos Tíscar, licensed by Sellex

FT15

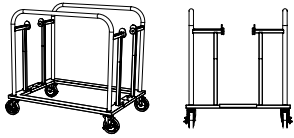

Fast Transport Trolley	MODEL	LIST PRICE
Black powder coat finish	FTT	\$2593
W 38.75 D 29.5 H 37.5	The Fast Transport Trolley can hold up to 6 table bases and 6 table tops.	

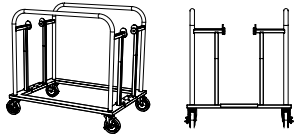

Fast Transport Trolley	MODEL	LIST PRICE
Black powder coat finish	FTT-72	\$2853
W 38.75 D 29.5 H 37.5	The Fast Transport Trolley can hold up to (6) C table bases and (4) 72 DIA table tops.	

To specify:
 Please refer to page 13-14 for complete
 specifying information. Specify all products by
 their product code.

5695 Eagle Drive, SE
Grand Rapids,
Michigan 49512
616-975-9260
lelandfurniture.com

Fixed Table

January 2024 Price List



Fixed Table

Table of Contents	FXT2
Visual Reference	FXT3
Specification Information	FXT4
Specification Example	FXT5
Power Planning	FXT6
Round Table	FXT7
Square Table	FXT8
Rectangular Table	FXT9
Counter Height Rectangular Tables	FXT11
Rectangular Bar Height Table	FXT13
Auxiliary Options	FXT15

TABLE MODEL	TABLE TOP SIZES	OPTIONAL POWER	PAGE
Round table	Round  42 DIA 48 DIA 54 DIA 60 DIA	1 Simplex Dual USB	6

TABLE MODEL	TABLE TOP SIZES	OPTIONAL POWER	PAGE
Square table	Square  42 x 42 48 x 48 54 x 54 60 x 60	1 Simplex Dual USB	7

TABLE MODEL	TABLE TOP SIZES	OPTIONAL POWER	PAGE
Rectangular table	Rectangle  30 x 60 36 x 72 42 x 84 30 x 72 36 x 84 42 x 96 30 x 84 36 x 96 42 x 120 36 x 120	2 Simplex units, 1 Dual USB 1 Simplex Dual USB	8

TABLE MODEL	TABLE TOP SIZES	OPTIONAL POWER	PAGE
Rectangular table Counter height	Rectangle  30 x 60 36 x 72 42 x 84 30 x 72 36 x 84 42 x 96 30 x 84 36 x 96 42 x 120 36 x 120	2 Simplex units, 1 Dual USB 1 Simplex Dual USB	9

TABLE MODEL	TABLE TOP SIZES	OPTIONAL POWER	PAGE
Rectangular table Bar height	Rectangle  30 x 60 36 x 72 42 x 84 30 x 72 36 x 84 42 x 96 30 x 84 36 x 96 42 x 120 36 x 120	2 Simplex units, 1 Dual USB 1 Simplex Dual USB	9

Table Model

DESCRIPTION	CODE
Fixed Table	FXT

Top Selection

ROUND

DESCRIPTION	CODE	DESCRIPTION	CODE
42D	42D-29	42x42	4242-29
48D	48D-29	48x48	4848-29
54D	54D-29	54x54	5454-29
60D	60D-29	60x60	6060-29

RECTANGULAR

DESCRIPTION	CODE	DESCRIPTION	CODE
30x60	3060-29	30x60	3060-36
30x72	3072-29	30x72	3072-36
30x84	3084-29	30x84	3084-36
36x72	3672-29	36x72	3672-36
36x84	3684-29	36x84	3684-36
36x96	3696-29	36x96	3696-36
36x120	36120-29	36x120	36120-36
42x84	4284-29	42x84	4284-36
42x96	4296-29	42x96	4296-36
42x120	42120-29	42x120	42120-36

BAR HEIGHT RECTANGULAR

DESCRIPTION	CODE
30x60	3060-42
30x72	3072-42
30x84	3084-42
36x72	3672-42
36x84	3684-42
36x96	3696-42
36x120	36120-42
42x84	4284-42
42x96	4296-42
42x120	42120-42

Top and Edge Finish

HPL (HIGH PRESSURE LAMINATE)

DESCRIPTION	CODE
Platinum Wilsonart® (D315-60)	LGP
Black Pionite® (SE101)	LBK
White Wilsonart® (D354-60)	LWH

Edge finish options: Matching ABS (V5), natural (11) plywood (W2)
 Please refer to the Leland Terms and Conditions Guide for a listing of standard laminates.
 For table pricing in laminates not listed, please contact Leland's Customer Experience Department for a quotation.

FORBO

DESCRIPTION	CODE
Pearl	4157
Mauve	4172
Pebble	4175
Smokey Blue	4179
Olive	4184

Edge finish options: natural (11) plywood (W2)

Pricing Effective: January 2024

Top and Edge Finish (cont.)

CORIAN





DESCRIPTION	CODE
Silverite	CG
Nocturne	CB
Cameo White	CW
Domino Terrazzo	CDT

Edge finish options: S1 Edge (CG, CB, & CW) and S2 Edge (CDT, CBT, & CPT)

Leg Finish

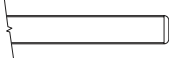
DESCRIPTION	CODE
White Textured Powder coat	WT
Black Textured Powder coat	BT

Edge Type

DESCRIPTION	CODE	DESCRIPTION	CODE
3/4" flat PVC	V5	1" flat plywood	W2
			
1" square (Solid Color Corian Tops)	S1	1" bullnose (Terrazzo Corian Tops)	S2
			

Glide Type

DESCRIPTION
Standard (Black nylon adjustable leveling)

Power Options

DESCRIPTION	CODE
Single Simplex Unit (centered)	PWR
Dual USB Unit (centered)	USB
Power Kit	KIT

*(2) Single Simplex & (1) Dual USB (only available on rectangular tables)

Auxiliary Options

DESCRIPTION	CODE
Storage Caddy	SC

*only available on rectangular tables

Specifications required to create the product code

- Model
- Top Selection
- Top Finish
- Leg Finish
- Edge Type
- Power (if applicable)
- Auxiliary Option (if applicable)
- Glide Type



MODEL

Fixed Table (FXT)

TOP SELECTION

Counter Height Rectangular
(3060-36)

TOP FINISH

Black Laminate (LBK)

LEG FINISH

Black Textured Powder coat (BT)

EDGE TYPE

1" flat plywood (W2)

POWER

When applicable enter power option (see page FXT6 for options)

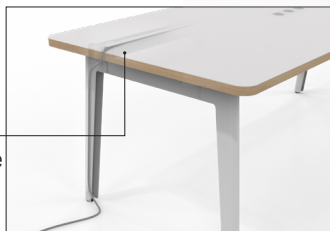

AUXILIARY OPTION

Storage Caddy (SC)

GLIDE

Standard (S)



Options

Single Simplex Unit (centered, includes 120" plug-in infeed) (PWR)

Dual USB Unit (centered) (USB)

Power Kit (KIT)

*(2) Single Simplex & (1) Dual USB (only available on rectangular tables, centered)



Single Simplex Unit



Dual USB



Wire Management

Power Kit (-KIT)

*(2) Single Simplex & (1) Dual USB (only available on rectangular tables, centered)

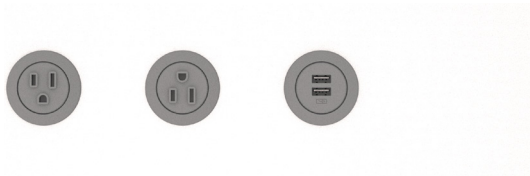

FIXED TABLE ROUND
 Design: 2B Studio, Justin Burton

FXT7



Fixed Table Round

	MODEL	TOP SIZE/CODE	LIST PRICE/EDGE CODES:	V5	W2
Powder coat base	FXT-	Laminate Top			
H 29		42D		\$2270	2612
		48D		\$2330	2749
		54D		\$2390	2869
Round		60D		\$2459	2999
42 DIA					
48 DIA		Forbo Top			W2
54 DIA		42D			\$2726
60 DIA		48D			\$2797
		54D			\$2870
		60D			\$2957
		Corian Top	S1		
		42D	\$5659		
		48D	\$5861		
		54D	\$6052		
		60D	\$6229		
		Terrazzo Corian Top	S2		
		42D	\$9374		
		48D	\$10893		
		54D	\$11878		
		60D	\$12856		

To specify:
 Please refer to pages 3-4 for complete specifying information.
 Specify all products by their product code.

Pricing Effective: January 2024

FIXED TABLE SQUARE
 Design: 2B Studio, Justin Burton

FXT8

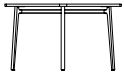

Fixed Table Square	MODEL	TOP SIZE/CODE	LIST PRICE/EDGE CODES:	V5	W2
Powder coat base	FXT-	Laminate Top			
H 29		42x42		\$2270	2612
		48x48		\$2330	2749
		54x54		\$2390	2869
	Square	60x60		\$2459	2999
42x42					
48x48		Forbo Top			W2
54x54		42x42			\$2726
60x60		48x48			\$2797
		54x54			\$2870
		60x60			\$2957
		Corian Top	S1		
		42x42	\$5659		
		48x48	\$2269		
		54x54	\$6052		
		60x60	\$6229		
		Terrazzo Corian Top	S2		
		42x42	\$9374		
		48x48	\$10893		
		54x54	\$11878		
		60x60	\$12856		

To specify:
 Please refer to pages 3-4 for complete specifying information.
 Specify all products by their product code.

Pricing Effective: January 2024

FIXED TABLE RECTANGULAR
 Design: 2B Studio, Justin Burton

FXT9



Fixed Table Rectangular	MODEL	TOP SIZE/CODE	LIST PRICE/EDGE CODES:	V5	W2
Powder coat base	FXT-	Laminate Top			
H 29		30x60		\$2390	2748
		30x72		\$2576	2963
		30x84		\$2749	3244
	Rectangle	36x72		\$2947	3478
30x60		36x84		\$3229	3873
30x72		36x96		\$3420	4170
30x84		36x120		\$3891	4862
36x84		42x84		\$3556	4407
36x96		42x96		\$3694	4580
36x120		42x120		\$3970	4928
42x84					
42x96		Forbo Top			W2
42x120		30x60			\$2939
		30x72			\$3169
		30x84			\$3385
		36x72			\$3625
		36x84			\$3941
		36x96			\$4171
		36x120			\$4717
		42x84			\$4351
		42x96			\$4524
		42x120			\$4872

To specify:
 Please refer to pages 3-4 for complete specifying information.
 Specify all products by their product code.

Pricing Effective: January 2024

FIXED TABLE RECTANGULAR cont.
 Design: 2B Studio, Justin Burton

FXT10



Fixed Table Rectangular

	MODEL	TOP SIZE/CODE	LIST PRICE/EDGE CODES:
Powder coat base	FXT-	Corian Top	S1
H 29		30x60	\$5807
		30x72	\$5969
		30x84	\$6166
		36x72	\$6342
		36x84	\$6512
		36x96	\$6654
		36x120	\$6966
		42x84	\$6821
		42x96	\$6948
		42x120	\$7200
		Terrazzo Corian Top	S2
		30x60	\$7361
		30x72	\$7924
		30x84	\$8449
		36x72	\$10860
		36x84	\$11883
		36x96	\$12574
		36x120	\$14289
		42x84	\$13089
		42x96	\$13739
		42x120	\$15041

To specify:
 Please refer to pages 3-4 for complete specifying information.
 Specify all products by their product code.

Pricing Effective: January 2024

FIXED TABLE COUNTER HEIGHT RECTANGULAR
 Design: 2B Studio, Justin Burton

FXT11

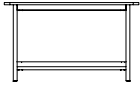

**Fixed Table Counter Height
 Rectangular**

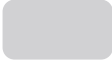
	MODEL	TOP SIZE/CODE	LIST PRICE/EDGE CODES:	V5	W2
Powder coat base	FXT-	Laminate Top			
H 36		30x60		\$3636	4181
		30x72		\$3773	4339
		30x84		\$3911	4614
	Rectangle	36x72		\$4031	4756
30x60		36x84		\$4151	4981
30x84		36x96		\$4259	5110
36x72		36x120		\$4486	5465
36x84		42x84		\$4414	5384
36x96		42x96		\$4474	5455
36x120		42x120		\$4594	5600
42x84					
42x96		Forbo Top			W2
42x120		30x60			\$3784
		30x72			\$3925
		30x84			\$4068
		36x72			\$4193
		36x84			\$4318
		36x96			\$4430
		36x120			\$4667
		42x84			\$4592
		42x96			\$4640
		42x120			\$4738

To specify:
 Please refer to pages 3-4 for complete specifying information.
 Specify all products by their product code.

Pricing Effective: January 2024

FIXED TABLE COUNTER HEIGHT RECTANGULAR cont.
 Design: 2B Studio, Justin Burton

FXT12



**Fixed Table Counter Height
 Rectangular**

	MODEL	TOP SIZE/CODE	LIST PRICE/EDGE CODES:
Powder coat base	FXT-	Corian Top	S1
H 36		30x60	\$6698
		30x72	\$6799
		30x84	\$6932
		36x72	\$7060
		36x84	\$7181
		36x96	\$7338
		36x120	\$7616
		42x84	\$7457
		42x96	\$7642
		42x120	\$8014
		Terrazzo Corian Top	S2
		30x60	\$9944
		30x72	\$10316
		30x84	\$10689
		36x72	\$13216
		36x84	\$13748
		36x96	\$13953
		36x120	\$14692
		42x84	\$14498
		42x96	\$14653
		42x120	\$14968

To specify:
 Please refer to pages 3-4 for complete specifying information.
 Specify all products by their product code.

Pricing Effective: January 2024

FIXED TABLE BAR HEIGHT RECTANGULAR
 Design: 2B Studio, Justin Burton

FXT13

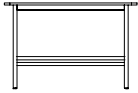

**Fixed Table Bar Height
 Rectangular**

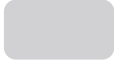
	MODEL	TOP SIZE/CODE	LIST PRICE/EDGE CODES:	V5	W2
Powder coat base	FXT-	Laminate Top			
H 42		30x60		\$3666	4216
		30x72		\$3803	4373
		30x84		\$3941	4650
Rectangle		36x72		\$4061	4790
30x60		36x84		\$4181	5017
30x72		36x96		\$4289	5146
36x72		36x120		\$4515	5501
36x84		42x84		\$4444	5422
36x96		42x96		\$4504	5495
36x120		42x120		\$4624	5641
42x84					
42x96		Forbo Top			W2
42x120		30x60			\$3814
		30x72			\$3956
		30x84			\$4098
		36x72			\$4222
		36x84			\$4349
		36x96			\$4448
		36x120			\$4672
		42x84			\$4621
		42x96			\$4670
		42x120			\$4769

To specify:
 Please refer to pages 3-4 for complete specifying information.
 Specify all products by their product code.

Pricing Effective: January 2024

FIXED TABLE BAR HEIGHT RECTANGULAR cont.
 Design: 2B Studio, Justin Burton

FXT14



**Fixed Table Bar Height
 Rectangular**

	MODEL	TOP SIZE/CODE	LIST PRICE/EDGE CODES:
Powder coat base	FXT-	Corian Top	S1
H 42		30x60	\$6792
		30x72	\$6905
		30x84	\$6952
		36x72	\$7081
		36x84	\$7206
		36x96	\$7340
		36x120	\$7598
		42x84	\$7484
		42x96	\$7666
		42x120	\$8031
		Terrazzo Corian Top	S2
		30x60	\$9906
		30x72	\$10278
		30x84	\$10649
		36x72	\$13168
		36x84	\$13558
		36x96	\$13908
		36x120	\$14647
		42x84	\$14412
		42x96	\$14826
		42x120	\$15654

To specify:
 Please refer to pages 3-4 for complete specifying information.
 Specify all products by their product code.

Pricing Effective: January 2024

Single Simplex Unit	MODEL	LIST PRICE
	PWR	\$143

Dual USB Unit	MODEL	LIST PRICE
	USB	\$255

Power Kit	MODEL	LIST PRICE
	KIT	\$1579

Fixed Table Storage Caddy	MODEL	LIST PRICE
	SC	\$464

To specify:
Please refer to pages 3-4 for
complete specifying information.
Specify all products by their
product code.

5695 Eagle Drive, SE
Grand Rapids,
Michigan 49512
616-975-9260
lelandfurniture.com

Fly Table

January 2024 Price List



Fly Table

Table of Contents	FLY2
Specification Information	FLY3
Specification Example	FLY4
Textured Paint	FLY5
HPL	FLY5
Wood Veneer	FLY6

Table Model

DESCRIPTION	CODE
Fly Table	FLY

Top Collection

RECTANGLE

DESCRIPTION	CODE	DESCRIPTION	CODE
30x60	3060	30D	30D
36x72	3672	36D	36D
42x84	4284	42D	42D

ROUND

DESCRIPTION	CODE
30D	30D
36D	36D
42D	42D
48D	48D

LEFT HAND 'L'

DESCRIPTION	CODE	DESCRIPTION	CODE
40x55	4055L	30x60	30600
46x63	4663L	36x72	36720
52x72	5272L	42x84	42840
		48x96	48960

OVAL

RIGHT HAND 'R'

DESCRIPTION	CODE
40x55	4055R
46x63	4663R
52x72	5272R

VISUAL REFERENCE:



Left and right hand designations are as seated.

Leg Selection

DESCRIPTION	CODE
Powder coat Legs	P
Polished Aluminum Legs	PA

Leg Finish (when applicable)

DESCRIPTION	CODE
White Textured Powder coat	WT
Black Textured Powder coat	BT

*Please Note: Leg finish specification is required ONLY for Powder coat (P) legs

Edge Type

STANDARD EDGE:

reverse back bevel

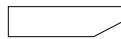

Glide Type

DESCRIPTION	CODE
Black Rubber Glide	S

Auxiliary Options

DESCRIPTION	CODE	DESCRIPTION	CODE
Power Flip Top Grommet	PT	Front Divider Screen	FD
Cable Duct	CD	Side Divider Screen	SD
Textile Cable Tray	CT	Courtesy Screen	CS
Ganging	G		

Auxiliary options are priced upon request. Please contact Customer Experience (800) 859-7510 for pricing.

Top and Edge Finish

WOOD VENEER TEXTURED PAINT

DESCRIPTION	CODE	DESCRIPTION	CODE
Rift Cut Oak	O	White	WT
Walnut	W	Black	BT
		Grey	GT

Edge finish options:

Natural	11	Edge finish painted to match
Oak stain match	O	
Walnut stain match	W	

HPL (HIGH PRESSURE LAMINATE)

DESCRIPTION	CODE
Grey	Platinum Wilsonart® (D315-60)
Black	Black Pionite® (SE101)
White Designer	White Wilsonart® (D354-60)

Edge Finish Natural (11) Plywood only

Specifications required to create the product code

- Table Model
- Top Selection
- Top Finish
- Leg Selection
- Leg Finish
- Glide Selection



MODEL

Fly Table (FLY)

TOP SELECTION

36 Diameter Round (36D)

TOP FINISH

White Textured Paint (WT)

EDGE FINISH

White Textured Paint (WT)

LEG SELECTION

Powder coat (P)

LEG FINISH

White Textured Paint (WT)

GLIDE SELECTION

Standard Glide (S)







FLY TABLE





Design: Lievore Altherr Molina, licensed by Sellex

FLY5

Textured Paint Top

			TOP SHAPE	TOP SIZE	POWDERCOAT LEGS	POLISHED ALUMINUM LEGS	
H 29.5	Top Shape		Rectangle	30x60	\$2174	2308	
				36x72	\$2501	2635	
				42x84	\$2887	3021	
			L - Table	40x55	\$2253	2386	
				46x63	\$2514	2647	
				52x72	\$2831	2964	
			Round	30D	\$1763	1897	
				36D	\$1911	2043	
				42D	\$2085	2220	
				48D	\$2289	2422	
				Oval	30x60	\$2176	2310
					36x72	\$2503	2637
				42x84	\$2889	3024	
				48x96	\$3064	3198	

HPL Top (High Pressure Laminate)

			TOP SHAPE	TOP SIZE	POWDERCOAT LEGS	POLISHED ALUMINUM LEGS
H 29.5	Top Shape		Rectangle	30x60	\$2174	2308
				36x72	\$2501	2635
				42x84	\$2887	3021
			L - Table	40x55	\$2341	2471
				46x63	\$2629	2761
				52x72	\$2976	3108
			Round	30D	\$1803	1936
				36D	\$1967	2099
				42D	\$2161	2292
				48D	\$2382	2515
			Oval	30x60	\$2257	2390
				36x72	\$2617	2750
				42x84	\$3043	3175
				48x96	\$3234	3368





To specify:
 Please refer to pages 3-4 for complete specifying information.
 Specify all products by their product code.

FLY TABLE

Design: Lievore Altherr Molina, licensed by Sellex

FLY6

Wood Veneer Top

		TOP SHAPE	TOP SIZE	POWDERCOAT LEGS	POLISHED ALUMINUM LEGS	
H 29.5	Top Shape		Rectangle	30x60	\$2276	2410
				36x72	\$2666	2798
				42x84	\$3127	3260
			L - Table	40x55	\$2471	2605
				46x63	\$2818	2950
				52x72	\$3233	3367
			Round	30D	\$1853	1986
				36D	\$2048	2182
				42D	\$2279	2414
				48D	\$2664	2797
			Oval	30x60	\$2369	2503
				36x72	\$2798	2930
				42x84	\$3305	3440
				48x96	\$3553	3686

To specify:

Please refer to pages 3-4 for complete specifying information.

Specify all products by their product code.

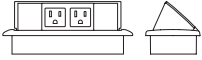

Power - Flip Top Grommet

LIST PRICE

2- 110v, 1 USB

\$1164



Ganging

LIST PRICE

Link tops frontally or on the side

\$182



Textile Cable Tray

LIST PRICE

2- 110v, 1 USB

\$182

Cable Duct

LIST PRICE

2- 110v, 1 USB

\$182

To specify:
Please refer to pages 3-4 for
complete specifying information.
Specify all products by their
product code.



Front Divider Panel

LIST PRICE

47.25W

\$968

Divider material is a rigid polyurethane, textured and laquered in your choice of Matte White, Black, or Grey.



Side Divider Panel

LIST PRICE

23.5W

\$605

Divider material is a rigid polyurethane, textured and laquered in your choice of Matte White, Black, or Grey.

To specify:
Please refer to pages 3-4 for complete specifying information.
Specify all products by their product code.

Pricing Effective: January 2024

**5695 Eagle Drive, SE
Grand Rapids,
Michigan 49512
616-975-9260
lelandfurniture.com**

Gemma

January 2024 Price List



Gemma

Table of Contents	GM2
Specification Information	GM3
Specification Example	GM4
Sled Base, Birch Shell	GM5
Sled Base, Oak Shell	GM6
Sled Base, Walnut Shell	GM7
Wood Base, Birch	GM8
Wood Base, Oak	GM9
Wood Base, Walnut	GM10
Task Base, Birch Shell	GM11
Task Base, Oak Shell	GM12
Task Base, Walnut Shell	GM13

Chair Model

DESCRIPTION	CODE
Gemma sled base	GEMS
Gemma sled base, upholstered seat	GEMSU
Gemma sled base, upholstered seat and back	GEMSUU
Gemma wood base	GEMW
Gemma wood base, upholstered seat	GEMWU
Gemma wood base, upholstered seat and back	GEMWUU
Gemma task base	GEMT
Gemma task base, upholstered seat	GEMTU
Gemma task base, upholstered seat and back	GEMTUU

Shell Veneer

DESCRIPTION	CODE
Birch	B
Oak	O
Walnut	W

Wood Shell & Wood Base Finishes

*Wood bases default to specified shell type

STANDARD SHELL/LEG (BIRCH):

DESCRIPTION	CODE
Natural	11
Graphite	25
Transparent Black	29
White Wash II	30
Forest	101M
Willow	108M

OAK SHELL/LEG:

DESCRIPTION	CODE
Natural White Oak	12
Morel	66M
Evergreen	112M
Sienna	113M
Blue Sky	114M

WALNUT SHELL/LEG:

DESCRIPTION	CODE
Natural Walnut	08M

Sled and Task Base Finishes

DESCRIPTION	CODE
Black	B
White	W
Black Textured	BT
White Textured	WT
Matte Mercury	MMR
Matte Mineral	MMN
Matte Burnish	MBN
Matte Foundry	MFN
Matte Blue Sky	MBS
Matte Forest	MFO
Matte Willow	MWL
Matte Sienna	MSN
Matte Pine	MPN
Chrome	C

Upholstery Selection

Please refer to Leland Textile Program which features textiles and leathers from the following partners:

- Camira
- Green Hides
- Carnegie
- Maharam
- CF Stinson
- Unika Vaev

The complete grade list can be found on our website or you can specify COM/COL. Due to the design of this product, it is recommended that all non pre-approved textile be tested for compatibility.

Glide Type

STANDARD:

DESCRIPTION	CODE
Nylon	S

OPTIONAL:

DESCRIPTION	CODE
Felt	FC

Caster Options

DESCRIPTION	CODE
Gemma task base	
Hard Floor	HF
Soft Floor	SF

Stacking note

The Gemma chair does not stack.

Specifications required to create the product code

- Model
- Wood Species
- Shell Finish
- Seat upholstery selection (when applicable)
- Leg Finish
- Back Upholstery Selection (when applicable)
- Glide Type



MODEL

Gemma Wood Base Chair (GEMW)

WOOD SPECIES

Oak (0)

SHELL FINISH

Natural White Oak (12)

SEAT UPHOLSTERY SELECTION

When applicable, enter upholstery grade, COM

LEG FINISH

Natural White Oak (12)

SEAT AND/OR BACK UPHOLSTERY SELECTION

When applicable, enter upholstery grade, COM



GEMMA SLED BASE CHAIR, BIRCH SHELL
 Design: Altherr Désile Park

GM5



Gemma Sled Base Chair	MODEL		LIST PRICE
Birch shell	GEMS-B	Powder Coat	\$995
W 22 D 22.75 H 30.25 SH 17.75		Chrome	\$1055

Optional Felt Glides: Add \$8.00 net per chair for a set of four (4).



Gemma Sled Base Chair	MODEL	LIST PRICE/GRADE	COM/COL	A	B	C	D	E	F	G	H	I	J	K	L
Birch shell, upholstered seat	GEMSU-B	Powder Coat	\$1120	1169	1193	1218	1243	1268	1293	1318	1343	1367	1392	1418	1442
W 22 D 22.75 H 30.25 SH 17.75		Chrome	\$1180	1228	1253	1278	1302	1327	1353	1378	1402	1427	1452	1476	1501

Optional Felt Glides: Add \$8.00 net per chair for a set of four (4).

COM Yardage: 1 Seat: .75 Yard

Contact Leland Customer Experience for yardage requirements on textiles with repeats.

For COL requirements please contact Leland Customer Experience.



Gemma Sled Base Chair	MODEL	LIST PRICE/ GRADE	COM/COL	A	B	C	D	E	F	G	H	I	J	K	L
Birch shell, upholstered seat and back	GEMSUU-B	Powder Coat	\$1250	1310	1367	1426	1485	1542	1601	1660	1718	1776	1835	1894	1951
W 22 D 22.75 H 30.25 SH 17.75		Chrome	\$1310	1368	1427	1486	1543	1602	1661	1719	1777	1836	1895	1952	2011

Optional Felt Glides: Add \$8.00 net per chair for a set of four (4).

COM Yardage: 1 Seat: 1.25 Yards

Contact Leland Customer Experience for yardage requirements on textiles with repeats.

For COL requirements please contact Leland Customer Experience.

Due to the curvature of the chair shell, we are not able to pattern match on the chair back and seat. If a directional fabric is being specified, add \$56 LIST for a pattern match in the center of the seat and back only.

To specify:

Please refer to pages 3-4 for complete specifying information.

Specify all products by their product code.

Pricing Effective: January 2024

GEMMA SLED BASE CHAIR, OAK SHELL
Design: Altherr Désile Park

GM6



Gemma Sled Base Chair	MODEL		LIST PRICE
Oak shell	GEMS-U	Powder Coat	\$1130
W 22 D 22.75 H 30.25 SH 17.75		Chrome	\$1190

Optional Felt Glides: Add \$8.00 net per chair for a set of four (4).



Gemma Sled Base Chair	MODEL	LIST PRICE/GRADE	COM/COL	A	B	C	D	E	F	G	H	I	J	K	L
Oak shell, upholstered seat	GEMS-U-0	Powder Coat	\$1255	1303	1328	1354	1379	1403	1428	1453	1478	1502	1528	1553	1577
W 22 D 22.75 H 30.25 SH 17.75		Chrome	\$1315	1363	1388	1413	1437	1463	1488	1513	1537	1562	1587	1612	1637

Optional Felt Glides: Add \$8.00 net per chair for a set of four (4).

COM Yardage: 1 Seat: .75 Yard

Contact Leland Customer Experience for yardage requirements on textiles with repeats.

For COL requirements please contact Leland Customer Experience.



Gemma Sled Base Chair	MODEL	LIST PRICE/ GRADE	COM/COL	A	B	C	D	E	F	G	H	I	J	K	L
Oak shell, upholstered seat and back	GEMS-UU-0	Powder Coat	\$1385	1445	1502	1561	1620	1678	1736	1795	1853	1911	1970	2029	2086
W 22 D 22.75 H 30.25 SH 17.75		Chrome	\$1445	1504	1562	1621	1679	1737	1796	1854	1912	1971	2030	2088	2146

Optional Felt Glides: Add \$8.00 net per chair for a set of four (4).

COM Yardage: 1 Seat: 1.25 Yards

Contact Leland Customer Experience for yardage requirements on textiles with repeats.

For COL requirements please contact Leland Customer Experience.

Due to the curvature of the chair shell, we are not able to pattern match on the chair back and seat. If a directional fabric is being specified, add \$56 LIST for a pattern match in the center of the seat and back only.

To specify:

Please refer to pages 3-4 for complete specifying information.

Specify all products by their product code.

Pricing Effective: January 2024

GEMMA SLED BASE CHAIR, WALNUT SHELL
 Design: Altherr Désile Park

GM7



Gemma Sled Base Chair	MODEL		LIST PRICE
Walnut shell	GEMS-W	Powder Coat	\$1320
W 22 D 22.75 H 30.25 SH 17.75		Chrome	\$1380

Optional Felt Glides: Add \$8.00 net per chair for a set of four (4).



Gemma Sled Base Chair	MODEL	LIST PRICE/GRADE	COM/COL	A	B	C	D	E	F	G	H	I	J	K	L
Walnut shell, upholstered seat	GEMSU-W	Powder Coat	\$1445	1493	1518	1542	1567	1593	1618	1642	1667	1692	1716	1742	1767
W 22 D 22.75 H 30.25 SH 17.75		Chrome	\$1504	1553	1577	1602	1627	1652	1677	1702	1727	1751	1776	1801	1826

Optional Felt Glides: Add \$8.00 net per chair for a set of four (4).

COM Yardage: 1 Seat: .75 Yard

Contact Leland Customer Experience for yardage requirements on textiles with repeats.

For COL requirements please contact Leland Customer Experience.



Gemma Sled Base Chair	MODEL	LIST PRICE/ GRADE	COM/COL	A	B	C	D	E	F	G	H	I	J	K	L
Walnut shell, upholstered seat and back	GEMSUU-W	Powder Coat	\$1574	1634	1692	1750	1809	1867	1873	1931	1989	2048	2106	2165	2223
W 22 D 22.75 H 30.25 SH 17.75		Chrome	\$1634	1693	1751	1810	1868	1927	1985	2043	2102	2160	2219	2277	2336

Optional Felt Glides: Add \$8.00 net per chair for a set of four (4).

COM Yardage: 1 Seat: 1.25 Yards

Contact Leland Customer Experience for yardage requirements on textiles with repeats.

For COL requirements please contact Leland Customer Experience.

Due to the curvature of the chair shell, we are not able to pattern match on the chair back and seat. If a directional fabric is being specified, add \$56 LIST for a pattern match in the center of the seat and back only.

To specify:

Please refer to pages 3-4 for complete specifying information.

Specify all products by their product code.

Pricing Effective: January 2024

GEMMA WOOD BASE CHAIR, BIRCH
 Design: Altherr Désile Park

GM8



Gemma Wood Base Chair	MODEL	LIST PRICE
Birch shell/base	GEMW-B	\$1266
W 22 D 21 H SH 18	Optional Felt Glides: Add \$8.00 net per chair for a set of four (4).	



Gemma Wood Base Chair	MODEL	LIST PRICE/GRADE	COM/COL	A	B	C	D	E	F	G	H	I	J	K	L
Birch shell/base, upholstered seat	GEMWU-B		\$1390	1439	1464	1489	1514	1538	1563	1588	1613	1638	1663	1688	1712
W 22 D 21 H SH 18	Optional Felt Glides: Add \$8.00 net per chair for a set of four (4). COM Yardage: 1 Seat: .75 Yard Contact Leland Customer Experience for yardage requirements on textiles with repeats. For COL requirements please contact Leland Customer Experience.														



Gemma Wood Base Chair	MODEL	LIST PRICE/ GRADE	COM/COL	A	B	C	D	E	F	G	H	I	J	K	L
Birch shell/base, upholstered seat and back	GEMWUU-B		\$1509	1569	1627	1686	1744	1802	1861	1919	1977	2036	2094	2153	2211
W 22 D 21 H SH 18	Optional Felt Glides: Add \$8.00 net per chair for a set of four (4). COM Yardage: 1 Seat: 1.25 Yards Contact Leland Customer Experience for yardage requirements on textiles with repeats. For COL requirements please contact Leland Customer Experience. Due to the curvature of the chair shell, we are not able to pattern match on the chair back and seat. If a directional fabric is being specified, add \$56 LIST for a pattern match in the center of the seat and back only.														

To specify:
 Please refer to pages 3-4 for complete specifying information.
 Specify all products by their product code.

Pricing Effective: January 2024

GEMMA WOOD BASE CHAIR, OAK
Design: Altherr Désile Park

GM9



Gemma Wood Base Chair	MODEL	LIST PRICE
Oak shell/base	GEMW-0	\$1401
W 22 D 21 H SH 18	Optional Felt Glides: Add \$8.00 net per chair for a set of four (4).	



Gemma Wood Base Chair	MODEL	LIST PRICE/GRADE	COM/COL	A	B	C	D	E	F	G	H	I	J	K	L
Oak shell/base, upholstered seat	GEMWU-0		\$1526	1574	1599	1624	1648	1673	1699	1724	1748	1773	1798	1823	1847
W 22 D 21 H SH 18	Optional Felt Glides: Add \$8.00 net per chair for a set of four (4). COM Yardage: 1 Seat: .75 Yard Contact Leland Customer Experience for yardage requirements on textiles with repeats. For COL requirements please contact Leland Customer Experience.														



Gemma Wood Base Chair	MODEL	LIST PRICE/ GRADE	COM/COL	A	B	C	D	E	F	G	H	I	J	K	L
Oak shell/base, upholstered seat and back	GEMWUU-0		\$1656	1714	1773	1832	1890	1948	2007	2065	2123	2182	2241	2298	2357
W 22 D 21 H SH 18	Optional Felt Glides: Add \$8.00 net per chair for a set of four (4). COM Yardage: 1 Seat: 1.25 Yards Contact Leland Customer Experience for yardage requirements on textiles with repeats. For COL requirements please contact Leland Customer Experience. Due to the curvature of the chair shell, we are not able to pattern match on the chair back and seat. If a directional fabric is being specified, add \$56 LIST for a pattern match in the center of the seat and back only.														

To specify:
Please refer to pages 3-4 for complete specifying information.
Specify all products by their product code.

Pricing Effective: January 2024

GEMMA WOOD BASE CHAIR, WALNUT
Design: Altherr Désile Park

GM10



Gemma Wood Base Chair	MODEL	LIST PRICE
Walnut shell/base	GEMW-W	\$1591
W 22 D 21 H SH 18	Optional Felt Glides: Add \$8.00 net per chair for a set of four (4).	



Gemma Wood Base Chair	MODEL	LIST PRICE/GRADE	COM/COL	A	B	C	D	E	F	G	H	I	J	K	L
Walnut shell/base, upholstered seat	GEMWU-W		\$1714	1764	1789	1813	1838	1863	1887	1912	1938	1963	1987	2012	2037
W 22 D 21 H SH 18	Optional Felt Glides: Add \$8.00 net per chair for a set of four (4). COM Yardage: 1 Seat: .75 Yard Contact Leland Customer Experience for yardage requirements on textiles with repeats. For COL requirements please contact Leland Customer Experience.														



Gemma Wood Base Chair	MODEL	LIST PRICE/ GRADE	COM/COL	A	B	C	D	E	F	G	H	I	J	K	L
Walnut shell/base, upholstered seat and back	GEMWUU-W		\$1844	1904	1963	2020	2079	2138	2196	2254	2311	2372	2429	2488	2547
W 22 D 21 H SH 18	Optional Felt Glides: Add \$8.00 net per chair for a set of four (4). COM Yardage: 1 Seat: 1.25 Yards Contact Leland Customer Experience for yardage requirements on textiles with repeats. For COL requirements please contact Leland Customer Experience. Due to the curvature of the chair shell, we are not able to pattern match on the chair back and seat. If a directional fabric is being specified, add \$56 LIST for a pattern match in the center of the seat and back only.														

To specify:
Please refer to pages 3-4 for complete specifying information.
Specify all products by their product code.

Pricing Effective: January 2024

GEMMA TASK BASE CHAIR, BIRCH SHELL
 Design: Altherr Désile Park

GM11

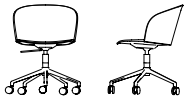

Gemma Task Base Chair	MODEL		LIST PRICE
Birch shell	GEMT-B	Black Textured	\$1353
W 22 D 25.25 H 28.25 - 31 SH 15.75 - 18.5		Powder Coat	\$1485

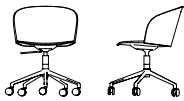

Gemma Task Base Chair	MODEL	LIST PRICE/GRADE	COM/COL	A	B	C	D	E	F	G	H	I	J	K	L
Birch shell, upholstered seat	GEMTU-B	Black Textured	\$1467	1517	1541	1566	1591	1616	1640	1665	1690	1714	1739	1764	1789
W 22 D 25.25 H 28.25 - 31 SH 15.75 - 18.5		Powder Coat	\$1599	1648	1673	1698	1723	1747	1772	1797	1822	1846	1871	1896	1920

COM Yardage: 1 Seat: .75 Yard
 Contact Leland Customer Experience for yardage requirements on textiles with repeats.
 For COL requirements please contact Leland Customer Experience.

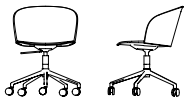

Gemma Task Base Chair	MODEL	LIST PRICE/ GRADE	COM/COL	A	B	C	D	E	F	G	H	I	J	K	L
Birch shell, upholstered seat and back	GEMTUU-B	Black Textured	\$1613	1673	1732	1791	1849	1908	1967	2025	2084	2143	2202	2260	2319
W 22 D 25.25 H 28.25 - 31 SH 15.75 - 18.5		Powder Coat	\$1745	1805	1864	1922	1981	2040	2099	2157	2216	2275	2333	2392	2451

COM Yardage: 1 Seat: 1.25 Yards
 Contact Leland Customer Experience for yardage requirements on textiles with repeats.
 For COL requirements please contact Leland Customer Experience.
 Due to the curvature of the chair shell, we are not able to pattern match on the chair back and seat. If a directional fabric is being specified, add \$56 LIST for a pattern match in the center of the seat and back only.

To specify:
 Please refer to pages 3-4 for complete specifying information.
 Specify all products by their product code.

GEMMA TASK BASE CHAIR, OAK SHELL
 Design: Altherr Désile Park

GM12

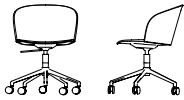

Gemma Task Base Chair	MODEL		LIST PRICE
Oak shell	GEMT-O	Black Textured	\$1412
W 22 D 25.25 H 28.25 - 31 SH 15.75 - 18.5		Powder Coat	\$1543

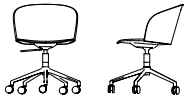

Gemma Task Base Chair	MODEL	LIST PRICE/GRADE	COM/COL	A	B	C	D	E	F	G	H	I	J	K	L
Oak shell, upholstered seat	GEMTU-O	Black Textured	\$1526	1575	1600	1625	1650	1674	1699	1724	1748	1773	1798	1823	1847
W 22 D 25.25 H 28.25 - 31 SH 15.75 - 18.5		Powder Coat	\$1658	1707	1732	1757	1781	1806	1831	1856	1880	1905	1930	1954	1979

COM Yardage: 1 Seat: .75 Yard
 Contact Leland Customer Experience for yardage requirements on textiles with repeats.
 For COL requirements please contact Leland Customer Experience.

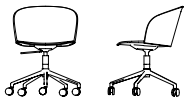

Gemma Task Base Chair	MODEL	LIST PRICE/ GRADE	COM/COL	A	B	C	D	E	F	G	H	I	J	K	L
Oak shell, upholstered seat and back	GEMTUU-O	Black Textured	\$1672	1732	1791	1849	1908	1967	2025	2084	2143	2202	2260	2319	2378
W 22 D 25.25 H 28.25 - 31 SH 15.75 - 18.5		Powder Coat	\$1804	1864	1922	1981	2040	2099	2157	2216	2275	2333	2392	2451	2510

COM Yardage: 1 Seat: 1.25 Yards
 Contact Leland Customer Experience for yardage requirements on textiles with repeats.
 For COL requirements please contact Leland Customer Experience.
 Due to the curvature of the chair shell, we are not able to pattern match on the chair back and seat. If a directional fabric is being specified, add \$56 LIST for a pattern match in the center of the seat and back only.

To specify:
 Please refer to pages 3-4 for complete specifying information.
 Specify all products by their product code.

Pricing Effective: January 2024

GEMMA TASK BASE CHAIR, WALNUT SHELL
 Design: Altherr Désile Park

GM13

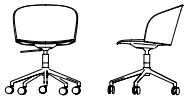

Gemma Task Base Chair	MODEL		LIST PRICE
Walnut shell	GEMT-W	Black Textured	\$1457
W 22 D 25.25 H 28.25 - 31 SH 15.75 - 18.5		Powder Coat	\$1589

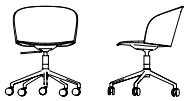

Gemma Task Base Chair	MODEL	LIST PRICE/GRADE	COM/COL	A	B	C	D	E	F	G	H	I	J	K	L
Walnut shell, upholstered seat	GEMTU-W	Black Textured	\$1571	1621	1645	1670	1695	1720	1744	1769	1794	1818	1843	1868	1893
W 22 D 25.25 H 28.25 - 31 SH 15.75 - 18.5		Powder Coat	\$1702	1751	1776	1801	1826	1850	1875	1900	1925	1949	1974	1999	2023

COM Yardage: 1 Seat: .75 Yard
 Contact Leland Customer Experience for yardage requirements on textiles with repeats.
 For COL requirements please contact Leland Customer Experience.

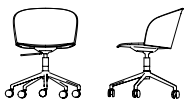

Gemma Task Base Chair	MODEL	LIST PRICE/ GRADE	COM/COL	A	B	C	D	E	F	G	H	I	J	K	L
Walnut shell, upholstered seat and back	GEMTUU-W	Black Textured	\$1718	1777	1836	1895	1953	2012	2071	2130	2188	2247	2306	2364	2423
W 22 D 25.25 H 28.25 - 31 SH 15.75 - 18.5		Powder Coat	\$1849	1909	1968	2027	2085	2144	2203	2261	2320	2379	2437	2496	2555

COM Yardage: 1 Seat: 1.25 Yards
 Contact Leland Customer Experience for yardage requirements on textiles with repeats.
 For COL requirements please contact Leland Customer Experience.
 Due to the curvature of the chair shell, we are not able to pattern match on the chair back and seat. If a directional fabric is being specified, add \$56 LIST for a pattern match in the center of the seat and back only.

To specify:
 Please refer to pages 3-4 for complete specifying information.
 Specify all products by their product code.

Pricing Effective: January 2024

5695 Eagle Drive, SE
Grand Rapids,
Michigan 49512
616-975-9260
lelandfurniture.com

Gemma Occasional Table

January 2024 Price List



Gemma Occasional Table

Table of Contents	G02
Visual Reference	G03
Specification Information	G04
Specification Example	G05
Power Planning	G06
Sled Base	G07
Wood Base	G07
Totem Base	G08
Height Adjustable Base	G08

TABLE MODEL		TABLE TOP SIZES & BASE HEIGHT	BASE	PAGE
Sled Base (GETS)		32 DIA, 15H	Powder Coat	Page G07
		32 DIA, 18H		
		20 DIA, 22H		
		20 DIA, 26H		

TABLE MODEL		TABLE TOP SIZES	BASE	PAGE
Wood Base (GETW)		32 DIA, 15H	Birch	Page G07
		32 DIA, 18H	Walnut	
		20 DIA, 22H	Oak	
		20 DIA, 26H	Painted Wood	

TABLE MODEL		TABLE TOP SIZES	BASE	PAGE
Totem Base (GETT)		32 DIA, 15H	Powder Coat	Page G08
		32 DIA, 18H		
		20 DIA, 22H		
		20 DIA, 26H		

TABLE MODEL		TABLE TOP SIZES	BASE	PAGE
Height Adjustable (GETH)		32 DIA, 23-29H	Powder Coat	Page G08

Model

DESCRIPTION	CODE
Gemma occasional table, sled base	GETS
Gemma occasional table, wood base	GETW
Gemma occasional table, totem base	GETT
Gemma occasional table, height adjustable base	GETH

Top Size & Base Height

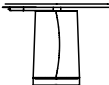
SLED BASE:

DESCRIPTION	CODE
32D, 15H	3215
32D, 18H	3218
20D, 22H	2022
20D, 26H	2026

WOOD BASE:

DESCRIPTION	CODE
32D, 15H	3215
32D, 18H	3218
20D, 22H	2022
20D, 26H	2026

TOTEM BASE:

DESCRIPTION	CODE
32D, 15H	3215
32D, 18H	3218
20D, 22H	2022
20D, 26H	2026

HEIGHT ADJUSTABLE BASE:

DESCRIPTION	CODE
32D, 23-29H	3229

Top Type

WOOD

DESCRIPTION	CODE
Birch	B
Oak	O
Walnut	W
Painted Wood	P

Top & Wood Base Finishes

*Wood bases default to specified top type except Painted Tops which pair with oak bases.

BIRCH FINISH OPTIONS

DESCRIPTION	CODE
Natural	11
Graphite	25
Transparent Black	29
White Wash II	30
Blue Sky	100M
Forest	101M
Sienna	106M
Willow	108M

OAK FINISH OPTIONS

DESCRIPTION	CODE
Natural White Oak	12
Morel	66M

WALNUT FINISH OPTIONS

DESCRIPTION	CODE
Natural Walnut	08M

TEXTURED PAINT (TOPS ONLY)

DESCRIPTION	CODE
White	WT
Black	BT

Sled & Totem Base Finishes

DESCRIPTION	CODE
Black	B
White	W
Black Textured	BT
White Textured	WT
Matte Mercury	MMR
Matte Mineral	MMN
Matte Burnish	MBN
Matte Foundry	MFN
Matte Blue Sky	MBS
Matte Forest	MFO
Matte Willow	MWL
Matte Sienna	MSN
Chrome (Sled Base Only)	C

Power Option

DESCRIPTION	CODE
Dual USB Unit	USB

*Available only on 22H and 26H Totem Base

Specifications required to create the product code

- Model
- Top Size
- Top Type
- Top Finish
- Base Height
- Base Finish



MODEL

Height Adjustable (GETH)

TOP SIZE

32 DIA (32)

TOP TYPE

Oak (0)

TOP FINISH

Natural White Oak (12)

BASE HEIGHT

23-29" (29)

BASE FINISH

Matte Willow Powder Coat (MWL)



Options

- Dual USB Unit (USB), standard cord

*Available only on 22H and 26H Totem Base



Dual USB



**Gemma Occasional Table,
Power Options**

	MODEL	LIST PRICE
Available on 22" Height and 26" Height Totem Base	USB Dual USB Unit	\$246

GEMMA OCCASIONAL TABLE
Design: Altherr Désile Park

GO7



**Gemma Occasional Table,
Sled Base**

	MODEL		TEXTURED PAINT TOP	BIRCH TOP	OAK TOP	WALNUT TOP
32" DIA, Up Edge 15" Height	GETS-3215	Powder Coat	\$1213	N/A	1439	1560
	GETS-3215	Chrome	\$1402	N/A	1662	1801
32" DIA Top, Up Edge 18" Height	GETS-3218	Powder Coat	\$1271	N/A	1497	1617
	GETS-3218	Chrome	\$1460	N/A	1719	1859
20" DIA Top, Waterfall Edge 22" Height	GETS-2022	Powder Coat	\$774	821	878	931
	GETS-2022	Chrome	\$890	943	1008	1069
20" DIA Top, Waterfall Edge 26" Height	GETS-2026	Powder Coat	\$1040	1098	1271	1444
	GETS-2026	Chrome	\$1194	1262	1460	1661



**Gemma Occasional Table,
Wood Base**

	MODEL		TEXTURED PAINT TOP, OAK BASE	BIRCH TOP, BIRCH BASE	OAK TOP, OAK BASE	WALNUT TOP, WALNUT BASE
32" DIA Top, Up Edge 15" Height	GETW-3215	Wood Base	\$1375	N/A	1583	1710
32" DIA Top, Waterfall Edge 18" Height	GETW-3218	Wood Base	\$1317	N/A	1525	1652
20" DIA Top, Waterfall Edge 22" Height	GETW-2022	Wood Base	\$815	861	919	971
20" DIA Top, Waterfall Edge 26" Height	GETW-2026	Wood Base	\$1213	1271	1502	1733

To specify:
Please refer to pages 3-5 for complete specifying information.
Specify all products by their product code.

Pricing Effective: January 2024

GEMMA OCCASIONAL TABLE
Design: Altherr Désile Park

G08



**Gemma Occasional Table,
Totem Base**

	MODEL		TEXTURED PAINT TOP	BIRCH TOP	OAK TOP	WALNUT TOP
32" DIA Top, Up Edge 15" Height	GETT-3215	Powder Coat	\$1377	N/A	1550	1620
32" DIA Top, Up Edge 18" Height	GETT-3218	Powder Coat	\$1502	N/A	1675	1745
20" DIA Top, Waterfall Edge 22" Height	GETT-2022	Powder Coat	\$873	919	1086	1254
20" DIA Top, Waterfall Edge 26" Height	GETT-2026	Powder Coat	\$1560	1617	1762	1906

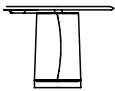

**Gemma Occasional Table,
Height Adjustable**

	MODEL		TEXTURED PAINT TOP	OAK TOP	WALNUT TOP
32" DIA Top, Waterfall Edge 23" - 29" Height Adjustable	GETH-3229	Powder Coat	\$2923	3096	3165

To specify:
Please refer to pages 3-5 for complete specifying information.
Specify all products by their product code.

Pricing Effective: January 2024

**5695 Eagle Drive, SE
Grand Rapids,
Michigan 49512
616-975-9260
lelandfurniture.com**

Gemma Stitch

January 2024 Price List



Gemma Stitch

Table of Contents	GS2
Specification Information	GS3
Specification Example	GS4
Gemma Stitch	GS5
Gemma Stitch Handle	GS5
Gemma Stitch Return Swivel	GS5

Chair Model

DESCRIPTION	CODE
Gemma Stitch	GEML

Upholstery Selection

Please refer to Leland Textile Program which features textiles and leathers from the following partners:

- Camira
- Green Hides
- Carnegie
- Maharam
- CF Stinson
- Unika Vaev

The complete grade list can be found at Leland's website or you can specify COM/COL. Due to the design of this product, it is recommended that all non pre-approved textile be tested for compatibility.

Optional

DESCRIPTION	CODE
Gemma Stitch Handle	GH
Gemma Stitch Return Swivel	RS

*Handle not available on return swivel base model

Product Weight

DESCRIPTION	LBS
Gemma Stitch Wood Base	39

Specifications required to create the product code

- Model
- Upholstery Selection
- Handle (If Applicable)



MODEL

Gemma Stitch (GEML)

UPHOLSTERY SELECTION

Enter upholstery grade or COM

GEMMA STITCH HANDLE

When applicable, enter GH



GEMMA STITCH
Design: Altherr Désile Park

GS5

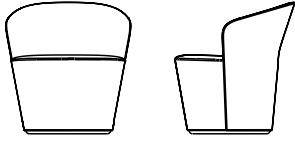

Gemma Stitch

W 24.5 D 26 H 30
SH 18

MODEL	LIST PRICE/ GRADE	COM/COL	A	B	C	D	E	F	G	H	I	J	K	L
GEML		2564	2729	2838	2946	3053	3180	3307	3434	3577	3721	3863	4007	4150

COM Yardage: 3.25 Yards
Contact Leland Customer Experience for yardage requirements on textiles with repeats.
For COL requirements please contact Leland Customer Experience.

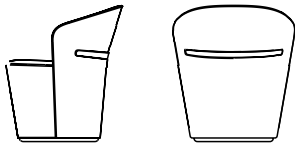

Gemma Stitch Handle

MODEL	LIST PRICE
GH	50

*Handle not available on return swivel base model

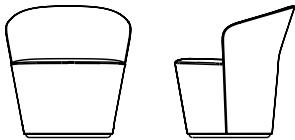

**Gemma Stitch,
Return Swivel Base**

W 24.5 D 26 H 30
SH 18

MODEL	LIST PRICE/ GRADE	COM/COL	A	B	C	D	E	F	G	H	I	J	K	L
GEML-RS		2692	2866	2979	3093	3205	3338	3472	3606	3755	3906	4057	4208	4358

COM Yardage: 3.25 Yards
Contact Leland Customer Experience for yardage requirements on textiles with repeats.
For COL requirements please contact Leland Customer Experience.
*Handle not available on return swivel base model

To specify:
Please refer to pages 3-4 for complete specifying information.
Specify all products by their product code.

**5695 Eagle Drive, SE
Grand Rapids,
Michigan 49512
616-975-9260
lelandfurniture.com**

Gemma Table

January 2024 Price List



Gemma Table

Table of Contents	GT2
Visual Reference	GT3
Specification Information	GT4
Specification Example	GT5
Power Planning	GT6
Totem Base	GT7
Wood Base	GT7

TABLE MODEL		TOP SIZES & HEIGHT	BASE	PAGE
Totem Base (GETT)		42 DIA, 29H 48 DIA, 29H	Powder Coat	Page GT7

TABLE MODEL		TOP SIZES & HEIGHT	BASE	PAGE
Wood Base, Round Top (GETD)		42 DIA, 29H 48 DIA, 29H	Beech Walnut Oak	Page GT7



TABLE MODEL		TOP SIZES & HEIGHT	BASE	PAGE
Wood Base, Soft Square Top (GETD)		42x42, 29H 48x48, 29H	Beech Walnut Oak	Page GT7

TABLE MODEL		TOP SIZES & HEIGHT	BASE	PAGE
Wood Base, Soft Rectangle Top (GETD)		60x36, 29H 72x36, 29H 84x42, 29H 96x42, 29H	Beech Walnut Oak	Page GT7

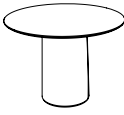
Model

DESCRIPTION	CODE
Gemma table, totem base	GETT
Gemma table, wood base	GETD

Top Size & Base Height

TOTEM BASE:

DESCRIPTION	CODE
42D, 29H	42D
48D, 29H	48D

WOOD BASE:

DESCRIPTION	CODE
42x42, 29H	4242
42D, 29H	42D
48x48, 29H	4848
48D, 29H	48D
60x36, 29H	6036
72x36, 29H	7236
84x42, 29H	8442
96x42, 29H	9642

Top Material

WOOD

DESCRIPTION	CODE
Beech	B
Oak	O
Walnut	W
Forbo	F
Laminate	L

Top & Wood Base Finishes

*Wood bases default to specified top type except Laminate and Forbo which pair with Beech bases, unless otherwise specified.

BEECH FINISH OPTIONS

DESCRIPTION	CODE
Natural	11
Graphite	25
Transparent Black	29
White Wash II	30
Blue Sky	100M
Forest	101M
Sienna	106M
Willow	108M

OAK FINISH OPTIONS

DESCRIPTION	CODE
Natural White Oak	12
Morel	66M

WALNUT FINISH OPTIONS

DESCRIPTION	CODE
Natural Walnut	08M

FORBO FINISH OPTIONS

DESCRIPTION	CODE
Smokey Blue	4179
Powder	4185
Pebble	4175
Olive	4184
Mauve	4172

LAMINATE FINISH OPTIONS

DESCRIPTION	CODE
Platinum Wilsonart® (D315-60)	LGP
Black Pionite® (SE101)	LBK
White Wilsonart® (D354-60)	LWH

Totem Base Finishes

DESCRIPTION	CODE
Black	B
White	W
Black Textured	BT
White Textured	WT
Matte Mercury	MMR
Matte Mineral	MMN
Matte Burnish	MBN
Matte Foundry	MFN
Matte Blue Sky	MBS
Matte Forest	MFO
Matte Willow	MWL
Matte Sienna	MSN

Power Option

1 Simplex, 1 USB A+C

DESCRIPTION	CODE
Edge Mounted, White	PEM-W
Edge Mounted, Black	PEM-B
In-Surface, White	PIS-W
In-Surface, Black	PIS-B

*Totem base models with power must choose from in-surface power options

Edge Types

DESCRIPTION	CODE
Wood Edge	W7
Flat PVC Edge	V6

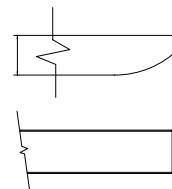

*W7 edge on Beech, Oak, Walnut, and Forbo tops only.

^V6 edge on Laminate tops only.

Specifications required to create the product code

- Model
- Top Size
- Top Type
- Top Finish
- Base Finish
- Power Option (Optional)



MODEL

Gemma Table, Wood Base (GETD)

TOP SIZE

42 DIA (42D)

TOP TYPE

Oak (0)

TOP FINISH

Natural White Oak (12)

BASE HEIGHT

29 Inches

BASE FINISH

Natural White Oak (12)



Options

- 1 Simplex, 1 USB A+C, braided cord
- Edge Mounted and In-Surface options available on Wood Base Models
- In-Surface options available on Totem Base Models
- Cord Length: Differs based on table size. All tables will have approximately 2' of additional cord from the base of the leg.

Edge Mounted Power



Wire Management



In-Surface Power

**Gemma Table,
Power Options**

	MODEL	LIST PRICE
1 Simplex, 1 USB A+C Braided Cord	PEM-W Edge Mounted, White	\$195
	PEM-B Edge Mounted, Black	\$195
	PIS-W In-Surface, White	\$303
	PIS-B In Surface, Black	\$303

*Edge Mounted Power located 3 inches from edge of table leg

GEMMA TABLE
Design: Altherr Désile Park

GT7

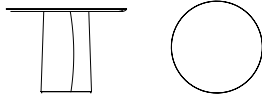

**Gemma Table,
Totem Base**

	MODEL	BASE	LAMINATE TOP	BEECH TOP	OAK TOP	WALNUT TOP	FORBO TOP
42" DIA, 29" Height	GETT-42D	Powder Coat	\$4080	4377	4478	4478	4478
48" DIA, 29" Height	GETT-48D	Powder Coat	\$4443	4738	4840	4840	4840

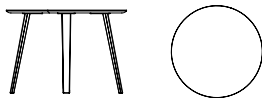

**Gemma Table,
Wood Base**

	MODEL	BASE	LAMINATE TOP	BEECH TOP	OAK TOP	WALNUT TOP	FORBO TOP
42" DIA, 29" Height	GETD-42D	Wood Base	\$3380	3677	3776	3776	3776
48" DIA, 29" Height	GETD-48D	Wood Base	\$3743	4040	4142	4142	4142



**Gemma Table,
Wood Base**

	MODEL	BASE	LAMINATE TOP	BEECH TOP	OAK TOP	WALNUT TOP	FORBO TOP
42"x42", 29" Height	GETD-4242	Wood Base	\$3380	3677	3677	3776	3776
48"x48", 29" Height	GETD-4848	Wood Base	\$3743	4040	4040	4142	4142



**Gemma Table,
Wood Base**

	MODEL	BASE	LAMINATE TOP	BEECH TOP	OAK TOP	WALNUT TOP	FORBO TOP
60"x36", 29" Height	GETD-6036	Wood Base	\$4161	4458	4560	4560	4560
72"x36", 29" Height	GETD-7236	Wood Base	\$4582	4878	4977	4977	4977
84"x42", 29" Height	GETD-8442	Wood Base	\$5332	5628	5728	5728	5728
96"x42", 29" Height	GETD-9642	Wood Base	\$5456	5753	5853	5853	5853

To specify:

Please refer to pages 3-5 for complete specifying information.

Specify all products by their product code.

Pricing Effective: January 2024

**5695 Eagle Drive, SE
Grand Rapids,
Michigan 49512
616-975-9260
lelandfurniture.com**

Hammok

January 2024 Price List



Hammok

Table of Contents	HS2
Specification Information	HS3
Specification Example	HS4
Cantilever Chair	HS5
Cantilever Chair, Upholstered Onlay	HS5

Chair Model

DESCRIPTION	CODE
Hammok cantilever chair	HC
Hammok cantilever chair, upholstered onlay	HCU

Shell Finish

STANDARD LELAND COLORS

CUSTOM Specify Custom (01)

*Please note that Hammok is NOT AVAILABLE in the following finishes:
 Natural Walnut Matte (08M), Natural (11), Natural White Oak Matte (12M)

Frame Finish

DESCRIPTION	CODE
Sterling	ST
Warm Grey	WG
Cool Grey	CG
Black	B
White	W
Matte Mercury	MMR
Matte Mineral	MMN
Matte Burnish	MBN
Matte Foundry	MFN

Brushed Stainless Steel (Cantilever only) BSS

TEXTURED	CODE
Dolphin Textured	DLT
Oxford Textured	OXT
Black Textured	BT
White Textured	WT
Matte Blue Sky	MBS
Matte Forest	MFO
Matte Sienna	MSN
Matte Willow	MWL

Upholstered Onlay Selection

Please refer to Leland Textile Program which features textiles and leathers from the following partners:

- Camira
- Carnegie
- CF Stinson
- Green Hides
- Maharam
- Unika Vaev

The complete grade list can be found on our website or you can specify COM/COL. Due to the design of this product, it is recommended that all non pre-approved textile be tested for compatibility.

Arm Finish

Black molded ABS

Glide Type

STANDARD

DESCRIPTION	CODE
Nylon (Cantilever only)	S

Freight Note

Due to the size and nature of Hammok chairs, the Freight Program does not apply to this product. Please contact Customer Experience for a quote.

Specifications required to create the product code

- Model
- Shell Finish
- Frame Finish
- Upholstered Onlay Selection (when applicable)
- Glide Type



MODEL

Hammok Cantilever, upholstered onlay (HCU)

SHELL FINISH

Natural (11)

FRAME FINISH

Sterling (ST)

UPHOLSTERED ONLAY SELECTION

When applicable, enter upholstery grade, COM or COL.
Grade J (J)



HAMMOK CANTILEVER CHAIR
Design: Burkhard Vogtherr

HS5

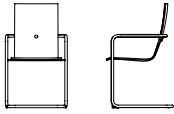

Hammok Cantilever Chair	MODEL	LIST PRICE
Powder coat frame	HC - ___	\$1047
W 22 D 22 H 34.5 SH 17.75 AH 25.875		

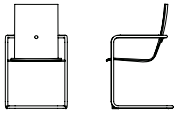

Hammok Cantilever Chair	MODEL	LIST PRICE
Brushed stainless steel frame	HC-BSS	\$1260
W 22 D 22 H 34.5 SH 17.75 AH 25.875		

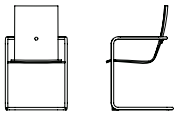

Hammok Cantilever	MODEL	LIST PRICE/ GRADE	COM/ COL	A	B	C	D	E	F	G	H	I	J	K	L
Powder coat frame, upholstered only	HCU - ___	\$1130	1198	1232	1265	1299	1332	1367	1401	1434	1468	1501	1536	1569	
COM Yardage: 1 or 2 chairs: 1.25 yards; 3 or 4 chairs: 2.5 yards Contact Leland Customer Experience for yardage requirements on textiles with repeats. For COL requirements please contact Leland Customer Experience.															
W 22 D 22 H 34.5 SH 17.75 AH 25.875															

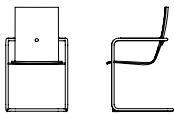

Hammok Cantilever	MODEL	LIST PRICE/ GRADE	COM/ COL	A	B	C	D	E	F	G	H	I	J	K	L
brushed stainless steel frame, upholstered only	HCU-BSS	\$1483	1551	1585	1618	1652	1685	1720	1753	1787	1819	1853	1888	1921	
COM Yardage: 1 or 2 chairs: 1.25 yards; 3 or 4 chairs: 2.5 yards Contact Leland Customer Experience for yardage requirements on textiles with repeats. For COL requirements please contact Leland Customer Experience.															
W 22 D 22 H 34.5 SH 17.75 AH 25.875															

To specify:
Please refer to pages 3-4 for complete specifying information.
Specify all products by their product code.

Pricing Effective: January 2024

**5695 Eagle Drive, SE
Grand Rapids,
Michigan 49512
616-975-9260
lelandfurniture.com**

Handy Stool

January 2024 Price List



Handy Stool

Table of contents	HA2
Specification Information	HA3
Specification Example	HA4
Handy Stool	HA5
Transport/Stacking Dolly	HA8

Model

DESCRIPTION	CODE
Handy Polypropylene	HYS-P
Handy Polypropylene Shell, Upholstered Onlay	HYS-U
Handy Polypropylene Shell, Wood Onlay	HYS-W
Handy Stool Transport Dolly, Single	HYD-S
Handy Stool Transport Dolly, Double	HYD-D

Shell Finish/Color

POLYPROPYLENE SHELL:

DESCRIPTION	CODE
White	WT
Recycled Black	RB
Grey	G
Pistachio	PS
Fawn	FW

CUSTOM POLYPROPYLENE COLORS

Custom color match is available upon request. Please contact hello@lelandfurniture.com for further information.

Upholstered Onlay Selection

Please refer to Leland Textile Program which features textiles and leathers from the following partners:

- Camira
- Carnegie
- CF Stinson
- Green Hides
- Maharam
- Unika Vaev

The complete grade list can be found on our website or you can specify COM/COL. Due to the design of this product, it is recommended that all non pre-approved textiles be tested for compatibility.

Wood Onlay Selection

DESCRIPTION	CODE
Natural Walnut	08M
Natural White Oak	12

LELAND COLORS (on maple)

Stacking Note

For Handy, ALL models stack as follows: (including upholstered and wood onlay)



Stack of 10: 44"H
Stack of 5: 29.5"H

Product Weight

DESCRIPTION	LBS
Handy Polypropylene - HYS-P	7
Handy Polypropylene Shell, Upholstered Onlay - HYS-U	8
Handy Polypropylene Shell, Wood Onlay - HYS-W	8

Specifications required to create the product code

- Model
- Shell Finish
- Wood Finish Species (when applicable)
- Wood Finish Code (when applicable)
- Upholstery Option (when applicable)

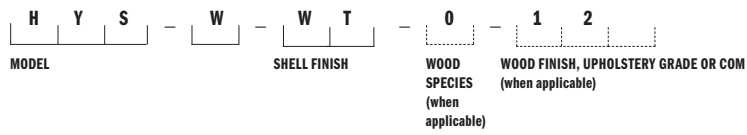

MODEL

Handy Stool (HYS)

ONLAY SELECTION

Wood (W)

SPECIES

Natural White Oak (12)

UPHOLSTERED ONLAY SELECTION

When applicable, enter upholstery grade, COM

POLYPROPYLENE SHELL FINISH

White (W)

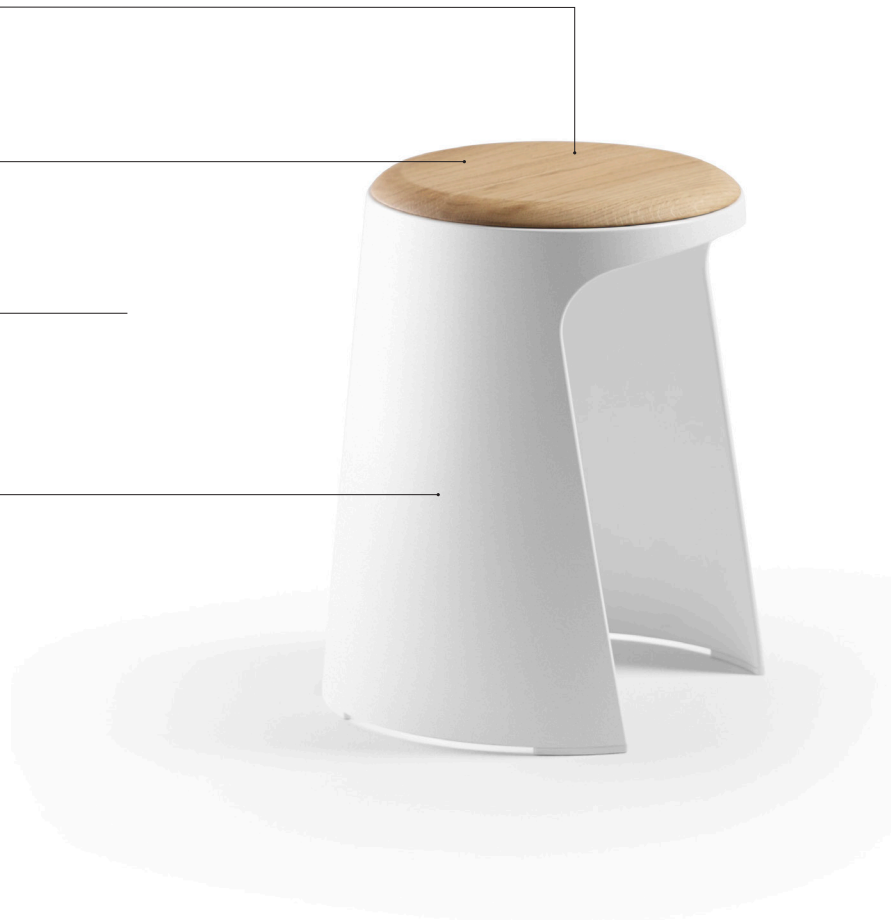

HANDY STOOL

Design: Stephen Philips (ARUP), licensed by Sellex

HA5



Handy Stool	MODEL	LIST PRICE
Polypropylene shell	HYS-P	\$199

W 16 D 14.5 H 18



Handy Stool	MODEL	LIST PRICE/GRADE	COM/COL	A	B	C	D	E	F	G	H	I	J	K	L
polypropylene shell,, upholstered seat onlay	HYS-U		\$342	354	365	377	388	400	411	423	434	446	458	469	526

W 16 D 14.5 H 18.25

COM Yardage: 1 or 2 seats: .75 yard; 3 or 4 seats: 1.5 yards; 5 or 6 seats: 2.25 yards
 Contact Leland Customer Experience for yardage requirements on textiles with repeats.
 For COL requirements please contact Leland Customer Experience.



Handy Stool	MODEL	LIST PRICE
Wood onlay	HYS-W	\$347

W 16 D 14.5 H 18.5

To specify:
 Please refer to pages 3-4 for complete specifying information.
 Specify all products by their product code.

Pricing Effective: January 2024

HANDY STOOL DOLLY

Design: Stephen Philips (ARUP), licensed by Sellex

HA6

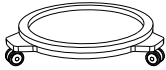

Handy Stool	MODEL	LIST PRICE
Single	HYD-S	\$894
W 20.75 D 20.75 H 3.75	*Product stacks 10 high on a single dolly.	

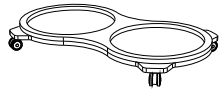

Handy Stool	MODEL	LIST PRICE
Double	HYD-D	\$1249
W 37 D 20.75 H 3.75	*Product stacks 10 high, 2 stacks on a double dolly.	

To specify:
Please refer to pages 3-4 for complete specifying information.
Specify all products by their product code.

Pricing Effective: January 2024

5695 Eagle Drive, SE
Grand Rapids,
Michigan 49512
616-975-9260
lelandfurniture.com

Leah Table

January 2024 Price List

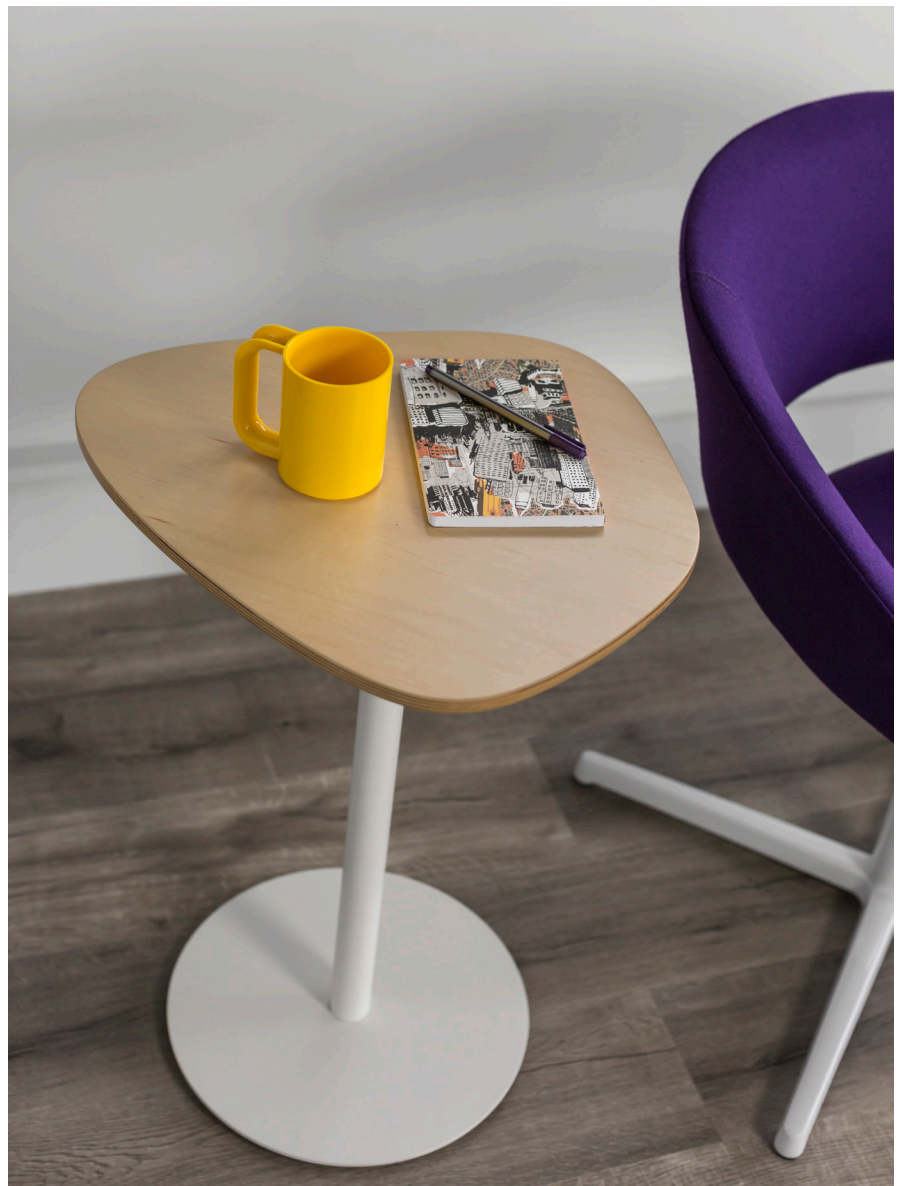

Leah Table

Table of Contents	LT2
Visual Reference	LT3
Specification Information	LT4
Specification Example	LT5
Ripple Table	LT6
Pond Table	LT7
Puddle Table	LT8
Soft Square Table	LT9
Round Table	LT10

TABLE MODEL		TABLE TOP SIZES	BASE	PAGE
Ripple (LTRP)		18x18 22x22 24x24 30x30	Powder Coat	Page LT6

TABLE MODEL		TABLE TOP SIZES	BASE	PAGE
Pond (LTPN)		22.5x15 45x30	Powder Coat	Page LT7



TABLE MODEL		TABLE TOP SIZES	BASE	PAGE
Puddle (LTPL)		22.5x15 45x30	Powder Coat	Page LT8

TABLE MODEL		TABLE TOP SIZES	BASE	PAGE
Soft Square (LTSS)		18x18 24x24 30x30	Powder Coat	Page LT9

Model

DESCRIPTION	CODE
Ripple	LTRP
Pond	LTPN
Puddle	LTPL
Soft Square	LTSS
Round	LTRD

Top Size

RIPPLE: POND/PUDDLE:

DESCRIPTION	CODE	DESCRIPTION	CODE
18x18	1818	22.5x15	2315
22x22	2222	45x30	4530
24x24	2424		
30x30	3030		

SOFT SQUARE: ROUND:

DESCRIPTION	CODE	DESCRIPTION	CODE
18x18	1818	18D	18D
24x24	2424	24D	24D
30x30	3030	30D	30D

Top Finish

LELAND COLORS

DESCRIPTION	CODE
Ash	A
Walnut *quarter cut veneer	W
Maple	MP

TEXTURED PAINT

DESCRIPTION	CODE
White	WT
Black	BT
Grey	GT

SOLID SURFACE

DESCRIPTION	CODE
Cameo White Corian®	CW
Silverite Corian®	CG
Nocturne Corian®	CB

BACK PAINTED GLASS

DESCRIPTION	CODE
White	WG
Black	BG

LAMINATE

DESCRIPTION	CODE
Kensington Maple Wilsonart®(10776-60)	LMP
Florence Walnut Wilsonart® (7993-38)	LWN
Black Pionite® (SE101)	LBK
White Wilsonart® (D354-60)	LWH

Base Height

DESCRIPTION	CODE
14"	14H
18"	18H
22"	22H
28" (Available with 18x18 Ripple, 18x18 Soft Square, and 18D and 24D Round Tops only)	28H

Base Finish

DESCRIPTION	CODE	DESCRIPTION	CODE
White Textured	WT	Oxford Textured	OXT
Black Textured	BT	Sterling	ST
Dolphin Textured	DT		

Glide Type

DESCRIPTION
Black HDPE Glide Plate

Edge Type

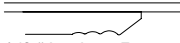
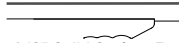
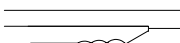
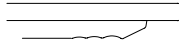
DESCRIPTION	DESCRIPTION
6mm Glass Top	1/2" Wood Top
	
1/2" Laminated Top	1/2" Solid Surface Top
	

Edge Options

LAMINATE EDGE FINISH

DESCRIPTION	CODE
Natural 11	

Specifications required to create the product code

- Model
- Top Size
- Top Finish
- Edge Type
- Edge Finish
- Base Height
- Base Finish

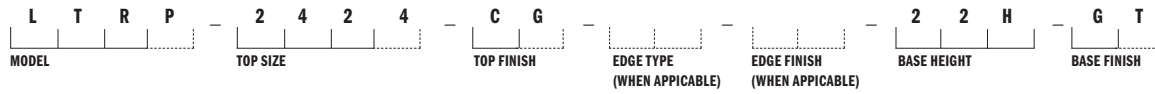

MODEL

Ripple (LTRP)

TOP SIZE

24x24 (2424)

TOP FINISH

Silverite Corian® (CG)

EDGE TYPE

Not applicable

EDGE FINISH

Not applicable

BASE HEIGHT

22" Base (22H)

BASE FINISH

Grey Textured Powder coat (GT)

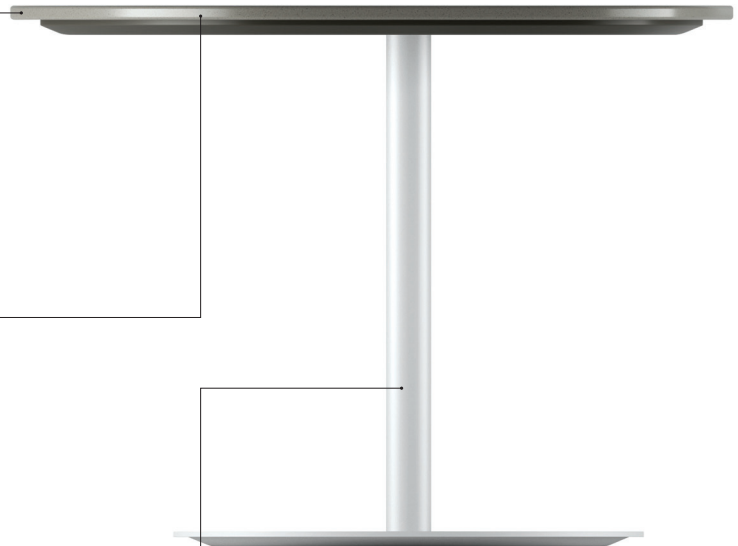

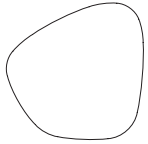

18" Ripple,

Powder Coat Base

	MODEL	TOP FINISH	TEXTURED PAINT	MAPLE	ASH	WALNUT	LAMINATE	BLACK PAINTED GLASS	SOLID SURFACE
18x18" Top	LTRP-1818	14" Base	\$1105	1216	1216	1275	1341	1554	1531
		18" Base	\$1116	1225	1225	1285	1354	1565	1543
		22" Base	\$1127	1235	1235	1295	1365	1573	1552
		28" Base	\$1150	1258	1258	1316	1386	1585	1564

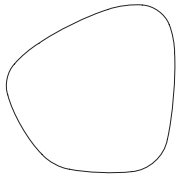

22" Ripple,

Powder Coat Base

	MODEL	TOP FINISH	TEXTURED PAINT	MAPLE	ASH	WALNUT	LAMINATE	BLACK PAINTED GLASS	SOLID SURFACE
22x22" Top	LTRP-2222	14" Base	\$1213	1331	1331	1405	1472	1941	1905
		18" Base	\$1223	1340	1340	1416	1482	1950	1918
		22" Base	\$1231	1353	1353	1425	1495	1959	1926

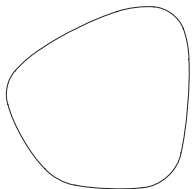

24" Ripple,

Powder Coat Base

	MODEL	TOP FINISH	TEXTURED PAINT	MAPLE	ASH	WALNUT	LAMINATE	BLACK PAINTED GLASS	SOLID SURFACE
24x24" Top	LTRP-2424	14" Base	\$1314	1442	1442	1520	1540	2088	2043
		18" Base	\$1320	1452	1452	1529	1549	2097	2053
		22" Base	\$1330	1462	1462	1541	1560	2108	2065

To specify:
Please refer to pages 4-5 for complete specifying information.
Specify all products by their product code.

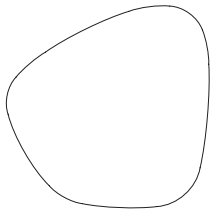

**30" Ripple,
Powder Coat Base**

	MODEL	TOP FINISH	TEXTURED PAINT	MAPLE	ASH	WALNUT	LAMINATE	BLACK PAINTED GLASS	SOLID SURFACE
30x30" Top	LTRP-3030	14" Base	\$1476	1619	1619	1716	1787	2728	2649
		18" Base	\$1483	1631	1631	1729	1794	2739	2659
		22" Base	\$1495	1642	1642	1737	1804	2746	2670

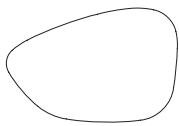

**22.5" Pond,
Powder Coat Base**

	MODEL	TOP FINISH	TEXTURED PAINT	MAPLE	ASH	WALNUT	LAMINATE	BLACK PAINTED GLASS	SOLID SURFACE
22.5x15" Top	LTPN-2315	14" Base	\$1226	1348	1348	1421	1566	2001	1986
		18" Base	\$1235	1356	1356	1431	1573	2006	1994
		22" Base	\$1243	1367	1367	1442	1586	2020	2007

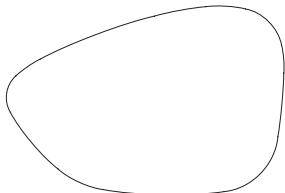

**45" Pond,
Powder Coat Base**

	MODEL	TOP FINISH	TEXTURED PAINT	MAPLE	ASH	WALNUT	LAMINATE	BLACK PAINTED GLASS	SOLID SURFACE
45x30" Top	LTPN-4530	14" Base	\$1925	2114	2114	2239	2330	3768	3641
		18" Base	\$1934	2123	2123	2250	2342	3777	3652
		22" Base	\$1941	2135	2135	2259	2352	3787	3662

To specify:
Please refer to pages 4-5 for complete specifying information.
Specify all products by their product code.

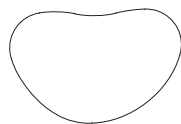

22.5" Puddle,

Powder Coat Base	MODEL	TOP FINISH	TEXTURED PAINT	MAPLE	ASH	WALNUT	LAMINATE	BLACK PAINTED GLASS	SOLID SURFACE
22.5x15" Top	LTPL-2315	14" Base	\$1226	1348	1348	1421	1566	2001	1986
		18" Base	\$1235	1356	1356	1431	1573	2006	1994
		22" Base	\$1243	1367	1367	1442	1586	2020	2007

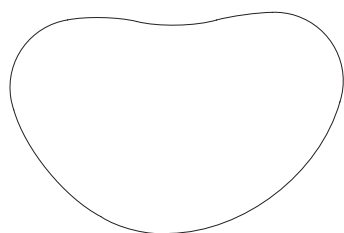

45" Puddle,

Powder Coat Base	MODEL	TOP FINISH	TEXTURED PAINT	MAPLE	ASH	WALNUT	LAMINATE	BLACK PAINTED GLASS	SOLID SURFACE
45x30" Top	LTPL-4530	14" Base	\$1925	2114	2114	2239	2330	3768	3641
		18" Base	\$1934	2123	2123	2250	2342	3777	3652
		22" Base	\$1941	2135	2135	2259	2352	3787	3662

To specify:
Please refer to pages 4-5 for complete specifying information.
Specify all products by their product code.

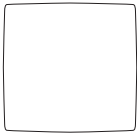

**18" Soft Square,
Powder Coat Base**

	MODEL	TOP FINISH	TEXTURED PAINT	MAPLE	ASH	WALNUT	LAMINATE	BLACK PAINTED GLASS	SOLID SURFACE
18x18" Top	LTSS-1818	14" Base	\$1220	1336	1336	1402	1468	1704	1685
		18" Base	\$1226	1349	1349	1414	1481	1715	1697
		22" Base	\$1237	1360	1360	1425	1495	1728	1708
		28" Base	\$1249	1372	1372	1440	1509	1746	1722

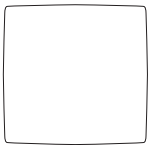

**24" Soft Square,
Powder Coat Base**

	MODEL	TOP FINISH	TEXTURED PAINT	MAPLE	ASH	WALNUT	LAMINATE	BLACK PAINTED GLASS	SOLID SURFACE
24x24" Top	LLTSS-2424	14" Base	\$1445	1586	1586	1671	1691	2289	2249
		18" Base	\$1455	1596	1596	1684	1700	2299	2257
		22" Base	\$1463	1607	1607	1695	1712	2310	2268

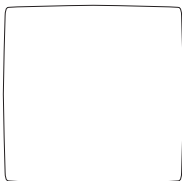

**30" Soft Square,
Powder Coat Base**

	MODEL	TOP FINISH	TEXTURED PAINT	MAPLE	ASH	WALNUT	LAMINATE	BLACK PAINTED GLASS	SOLID SURFACE
30x30" Top	LTSS-3030	14" Base	\$1622	1782	1782	1887	1956	2988	2915
		18" Base	\$1633	1793	1793	1898	1968	2999	2925
		22" Base	\$1643	1804	1804	1908	1977	3010	2936

To specify:
Please refer to pages 4-5 for complete specifying information.
Specify all products by their product code.

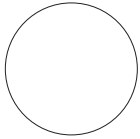

18" Round,

Powder Coat Base

	MODEL	TOP FINISH	TEXTURED PAINT	MAPLE	ASH	WALNUT	LAMINATE	BLACK PAINTED GLASS	SOLID SURFACE
18" Round Top	LTRD-18D	14" Base	\$1220	1336	1336	1402	1468	1704	1685
		18" Base	\$1226	1349	1349	1414	1481	1715	1697
		22" Base	\$1237	1360	1360	1425	1495	1728	1708
		28" Base	\$1257	1384	1384	1451	1517	1752	1734

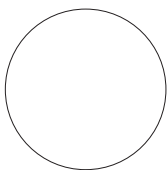

24" Round,

Powder Coat Base

	MODEL	TOP FINISH	TEXTURED PAINT	MAPLE	ASH	WALNUT	LAMINATE	BLACK PAINTED GLASS	SOLID SURFACE
24" Round Top	LTRD-24D	14" Base	\$1445	1586	1586	1671	1691	2289	2249
		18" Base	\$1455	1596	1596	1684	1700	2299	2257
		22" Base	\$1463	1607	1607	1695	1712	2310	2268
		28" Base	\$1483	1631	1631	1720	1739	2335	2296

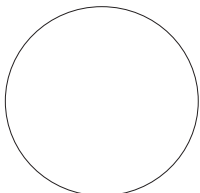

30" Round,

Powder Coat Base

	MODEL	TOP FINISH	TEXTURED PAINT	MAPLE	ASH	WALNUT	LAMINATE	BLACK PAINTED GLASS	SOLID SURFACE
30" Round Top	LTRD-30D	14" Base	\$1622	1782	1782	1887	1956	2988	2915
		18" Base	\$1633	1793	1793	1898	1968	2999	2925
		22" Base	\$1643	1804	1804	1908	1977	3010	2936

To specify:

Please refer to pages 4-5 for complete specifying information.

Specify all products by their product code.

5695 Eagle Drive, SE
Grand Rapids,
Michigan 49512
616-975-9260
lelandfurniture.com

M2 Seating

January 2024 Price List



M2 Seating

Table of Contents	M2S2
Specification Information	M2S3
Specification Example	M2S4
Side Chair	M2S5
Stacking Side Chair	M2S6
Counter Chair	M2S7
Stacking Counter Chair	M2S8
Bar Chair	M2S9
Stacking Bar Chair	M2S10
Transport/Stacking Dolly	M2S11





Chair Model

DESCRIPTION	CODE
M2 side chair	M2S
M2 side chair, upholstered seat	M2SU
M2 stacking side chair	M2SS
M2 stacking side chair, upholstered seat	M2SSU
M2 counter chair	M2C
M2 counter chair, upholstered seat	M2CU
M2 stacking counter chair	M2CS
M2 stacking counter chair, upholstered seat	M2CSU
M2 bar chair	M2B
M2 bar chair, upholstered seat	M2BU
M2 stacking bar chair	M2BS
M2 stacking bar chair, upholstered seat	M2BSU

Shell Veneer

DESCRIPTION	CODE
Standard	S
Walnut	W

Shell Cut Out

DESCRIPTION	CODE	DESCRIPTION	CODE
 Plain	1	 Square	7
 Circle	2	 Soft Square	9
Rectangle	8		

Shell Finish

STANDARD SHELL:

STANDARD LELAND COLORS

CUSTOM SPECIFY Custom (01)

*Please note that M2 Standard Shell is NOT AVAILABLE in the following finishes:
 Natural Walnut Matte (08M), Natural Beech (09), Natural White Oak Matte (12M)

WALNUT SHELL:

DESCRIPTION	CODE
Natural Walnut	08M

TWO-TONE SHELL:

DESCRIPTION	CODE
Black/Natural	BKC
White/Natural	WHC

Please note that the product is only available in the Natural Finishes listed above.

Frame Finish: Powder Coat and Chrome

DESCRIPTION	CODE	DESCRIPTION	CODE
Sterling	ST	Dolphin Textured	DLT
Warm Grey	WG	Oxford Textured	OXT
Cool Grey	B	Black Textured	BT
Black	CG	White Textured	WT
White	W		
Chrome	C		
Matte Mercury	MMR		
Matte Mineral	MMN		
Matte Burnish	MBN		
Matte Foundry	MFN		
Matte Blue Sky	MBS		
Matte Forest	MFO		
Matte Sienna	MSN		
Matte Willow	MWL		

Upholstered Onlay Selection

Please refer to Leland Textile Program which features textiles and leathers from the following partners:

- Camira
- Green Hides
- Carnegie
- Maharam
- CF Stinson
- Unika Vaev

The complete grade list can be found on our website or you can specify COM/COL. Due to the design of this product, it is recommended that all non pre-approved textile be tested for compatibility.

Glide Type

STANDARD:

DESCRIPTION	CODE
Nylon	S

OPTIONAL:

Please note that optional glides raise the chair height .5 inch.

DESCRIPTION	CODE
Felt	FC
Floor Saver™ (for VCT type floors)	FS
Metal	M
Rubber	R

Specifications required to create the product code

- Model
- Shell Veneer
- Cut Out
- Shell Finish
- Frame Finish
- Upholstery Selection (when applicable)
- Glide Type

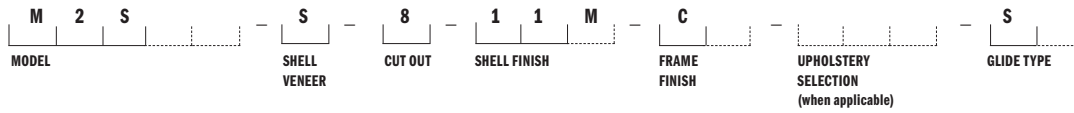

MODEL

M2 Side Chair (M2S)

SHELL VENEER

Standard (S)

CUT OUT

Rectangle (8)

SHELL FINISH

Natural (11M)

FRAME FINISH

Chrome (C)

UPHOLSTERY SELECTION

When applicable, enter upholstery grade, COM or COL



M2 SIDE CHAIR
Design: Leland Design Group

M2S5



M2 Side Chair	MODEL	FRAME FINISH	LIST PRICE
Standard shell W 22 D 21.5 H 32.25 SH 17.5	M2S-S	Powder Coat	\$600
		Chrome	\$649

Optional Glides: Add \$8.00 net per chair for a set of four (4). Optional Glides raise chair height .5 inch.



M2 Side Chair	MODEL	LIST PRICE/GRADE	COM/COL	A	B	C	D	E	F	G	H	I	J	K	L
Standard Shell Upholstered seat W 22 D 21.5 H 32.25 SH 18.5	M2SU-S	Powder Coat	\$682	730	753	778	802	827	850	875	900	924	949	973	999
		Chrome	\$731	778	802	827	850	875	900	924	949	973	999	1021	1047

Optional Glides: Add \$8.00 net per chair for a set of four (4). Optional Glides raise chair height .5 inch.

COM Yardage: 1 to 4 Seats: 1.5 yards

Contact Leland Customer Experience for yardage requirements on textiles with repeats.

For COL requirements please contact Leland Customer Experience..



M2 Side Chair	MODEL	FRAME FINISH	LIST PRICE
Walnut shell W 22 D 21.5 H 32.25 SH 18.5	M2S-W	Powder Coat	\$682
		Chrome	\$731

Optional Glides: Add \$8.00 net per chair for a set of four (4). Optional Glides raise chair height .5 inch.



M2 Side Chair	MODEL	LIST PRICE/GRADE	COM/COL	A	B	C	D	E	F	G	H	I	J	K	L
Walnut Shell, Upholstered seat W 22 D 21.5 H 32.25 SH 18.5	M2SU-W	Powder Coat	\$764	812	836	861	884	909	934	957	982	1007	1032	1055	1080
		Chrome	\$814	862	886	910	935	958	983	1008	1033	1056	1081	1107	1130

Optional Glides: Add \$8.00 net per chair for a set of four (4). Optional Glides raise chair height .5 inch.

COM Yardage: 1 to 4 Seats: 1.5 yards

Contact Leland Customer Experience for yardage requirements on textiles with repeats.

For COL requirements please contact Leland Customer Experience.

To specify:

Please refer to pages 3-5 for complete specifying information.

Specify all products by their product code.

M2 STACKING SIDE CHAIR
Design: Leland Design Group

M2S6



M2 Stacking Side Chair	MODEL	FRAME FINISH	LIST PRICE
Standard shell W 22 D 21.5 H 32.25 SH 17.5	M2SS-S	Powder Coat	\$631
		Chrome	\$682

Optional Glides: Add \$8.00 net per chair for a set of four (4). Optional Glides raise chair height .5 inch.



M2 Stacking Side Chair	MODEL	LIST PRICE/GRADE	COM/COL	A	B	C	D	E	F	G	H	I	J	K	L
Standard Shell Upholstered seat W 22 D 21.5 H 32.25 SH 18.5	M2SSU-S	Powder Coat	\$715	763	786	812	836	861	884	909	934	957	982	1007	1032
		Chrome	\$764	812	836	861	884	909	934	957	982	1007	1032	1055	1080

Optional Glides: Add \$8.00 net per chair for a set of four (4). Optional Glides raise chair height .5 inch.
COM Yardage: 1 to 4 Seats: 1.5 yards
Contact Leland Customer Experience for yardage requirements on textiles with repeats.
For COL requirements please contact Leland Customer Experience.



M2 Stacking Side Chair	MODEL	FRAME FINISH	LIST PRICE
Walnut shell W 22 D 21.5 H 32.25 SH 18.5	M2SS-W	Powder Coat	\$715
		Chrome	\$822

Optional Glides: Add \$8.00 net per chair for a set of four (4). Optional Glides raise chair height .5 inch.



M2 Stacking Side Chair	MODEL	LIST PRICE/GRADE	COM/COL	A	B	C	D	E	F	G	H	I	J	K	L
Walnut Shell, Upholstered seat W 22 D 21.5 H 32.25 SH 18.5	M2SSU-W	Powder Coat	\$797	844	868	892	917	942	967	990	1015	1039	1063	1087	1112
		Chrome	\$847	895	920	944	969	992	1017	1041	1066	1090	1115	1140	1163

Optional Glides: Add \$8.00 net per chair for a set of four (4). Optional Glides raise chair height .5 inch.
COM Yardage: 1 to 4 Seats: 1.5 yards
Contact Leland Customer Experience for yardage requirements on textiles with repeats.
For COL requirements please contact Leland Customer Experience.

To specify:
Please refer to pages 3-5 for complete specifying information.
Specify all products by their product code.

M2 COUNTER CHAIR
Design: Leland Design Group

M2S7



M2 Counter Chair	MODEL	FRAME FINISH	LIST PRICE
Standard shell W 21.5 D 21 H 37 SH 24.5	M2C-S	Powder Coat	\$889
		Chrome	\$942

Optional Glides: Add \$8.00 net per chair for a set of four (4). Optional Glides raise chair height .5 inch.



M2 Counter Chair	MODEL	LIST PRICE/GRADE	COM/COL	A	B	C	D	E	F	G	H	I	J	K	L
Standard Shell Upholstered seat W 21.5 D 21 H 37 SH 25.5	M2CU-S	Powder Coat	\$975	1021	1047	1072	1096	1120	1145	1170	1193	1218	1242	1267	1291
		Chrome	\$1025	1074	1098	1123	1147	1172	1195	1220	1245	1269	1293	1318	1343

Optional Glides: Add \$8.00 net per chair for a set of four (4). Optional Glides raise chair height .5 inch.
COM Yardage: 1 to 4 Seats: 1.5 yards
Contact Leland Customer Experience for yardage requirements on textiles with repeats.
For COL requirements please contact Leland Customer Experience.



M2 Counter Chair	MODEL	FRAME FINISH	LIST PRICE
Walnut shell W 21.5 D 21 H 37 SH 24.5	M2C-W	Powder Coat	\$975
		Chrome	\$1025

Optional Glides: Add \$8.00 net per chair for a set of four (4). Optional Glides raise chair height .5 inch.



M2 Counter Chair	MODEL	LIST PRICE/GRADE	COM/COL	A	B	C	D	E	F	G	H	I	J	K	L
Walnut Shell, Upholstered seat W 21.5 D 21 H 37 SH 25.5	M2CU-W	Powder Coat	\$1061	1109	1132	1158	1182	1207	1230	1255	1280	1303	1328	1353	1378
		Chrome	\$1112	1160	1184	1209	1233	1257	1282	1306	1331	1355	1380	1403	1429

Optional Glides: Add \$8.00 net per chair for a set of four (4). Optional Glides raise chair height .5 inch.
COM Yardage: 1 to 4 Seats: 1.5 yards
Contact Leland Customer Experience for yardage requirements on textiles with repeats.
For COL requirements please contact Leland Customer Experience.

To specify:
Please refer to pages 3-5 for complete specifying information.
Specify all products by their product code.

M2 STACKING COUNTER CHAIR
Design: Leland Design Group

M2S8

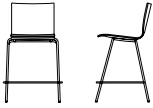

M2 Stacking Counter Chair	MODEL	FRAME FINISH	LIST PRICE
Standard shell	M2CS-S	Powder Coat	\$924
W 21.5 D 21 H 37 SH 24.5		Chrome	\$976

Optional Glides: Add \$8.00 net per chair for a set of four (4). Optional Glides raise chair height .5 inch.



M2 Stacking Counter Chair	MODEL	LIST PRICE/ GRADE	COM/COL	A	B	C	D	E	F	G	H	I	J	K	L
Standard Shell	M2CSU-S	Powder Coat	\$1013	1060	1084	1109	1132	1158	1182	1207	1230	1255	1280	1303	1328
Upholstered seat		Chrome	\$1061	1109	1132	1158	1182	1207	1230	1255	1280	1303	1328	1353	1378

W 21.5 D 21 H 37 SH 25.5

Optional Glides: Add \$8.00 net per chair for a set of four (4). Optional Glides raise chair height .5 inch.

COM Yardage: 1 to 4 Seats: 1.5 yards

Contact Leland Customer Experience for yardage requirements on textiles with repeats.

For COL requirements please contact Leland Customer Experience.



M2 Stacking Counter Chair	MODEL	FRAME FINISH	LIST PRICE
Walnut shell	M2CS-W	Powder Coat	\$1013
W 21.5 D 21 H 37 SH 24.5		Chrome	\$1061

Optional Glides: Add \$8.00 net per chair for a set of four (4). Optional Glides raise chair height .5 inch.



M2 Stacking Counter Chair	MODEL	LIST PRICE/ GRADE	COM/COL	A	B	C	D	E	F	G	H	I	J	K	L
Walnut Shell,	M2CSU-W	Powder Coat	\$1098	1146	1171	1194	1219	1243	1268	1292	1317	1341	1365	1390	1414
Upholstered seat		Chrome	\$1149	1196	1221	1246	1270	1294	1319	1344	1367	1393	1418	1442	1466

W 21.5 D 21 H 37 SH 25.5

Optional Glides: Add \$8.00 net per chair for a set of four (4). Optional Glides raise chair height .5 inch.

COM Yardage: 1 to 4 Seats: 1.5 yards

Contact Leland Customer Experience for yardage requirements on textiles with repeats.

For COL requirements please contact Leland Customer Experience.

To specify:

Please refer to pages 3-5 for complete specifying information.

Specify all products by their product code.

M2 BAR CHAIR
Design: Martin Ballendat

M2S9



M2 Bar Chair	MODEL	FRAME FINISH	LIST PRICE
Standard shell	M2B-S	Powder Coat	\$906
W 21.5 D 22 H 41.5 SH 29.5		Chrome	\$957

Optional Glides: Add \$8.00 net per chair for a set of four (4).



M2 Bar Chair	MODEL	LIST PRICE/GRADE	COM/ COL	A	B	C	D	E	F	G	H	I	J	K	L
Standard shell, upholstered seat onlay	M2BU-S	Powder Coat	\$991	1039	1063	1087	1112	1137	1161	1186	1210	1234	1258	1283	1307
		Chrome	\$1045	1093	1117	1143	1166	1191	1215	1240	1264	1289	1314	1337	1362

W 21.5 D 22 H 41.5 SH 30.5

Optional Glides: Add \$8.00 net per chair for a set of four (4). Optional Glides raise chair height .5 inch.
COM Yardage: 1 to 4 Seats: 1.5 yards
Contact Leland Customer Experience for yardage requirements on textiles with repeats.
For COL requirements please contact Leland Customer Experience.

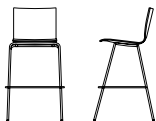

M2 Bar Chair	MODEL	FRAME FINISH	LIST PRICE
Walnut shell	M2B-W	Powder Coat	\$991
W 21.5 D 22 H 41.5 SH 29.5		Chrome	\$1045

Optional Glides: Add \$8.00 net per chair for a set of four (4). Optional Glides raise chair height .5 inch.



M2 Bar Chair	MODEL	LIST PRICE/GRADE	COM/ COL	A	B	C	D	E	F	G	H	I	J	K	L
Walnut shell, upholstered seat onlay	M2BU-W	Powder Coat	\$1080	1127	1151	1176	1203	1226	1251	1275	1299	1323	1348	1371	1397
		Chrome	\$1131	1180	1205	1228	1253	1277	1301	1325	1350	1376	1399	1424	1448

W 21.5 D 22 H 41.5 SH 30.5

Optional Glides: Add \$8.00 net per chair for a set of four (4). Optional Glides raise chair height .5 inch.
COM Yardage: 1 to 4 Seats: 1.5 yards
Contact Leland Customer Experience for yardage requirements on textiles with repeats.
For COL requirements please contact Leland Customer Experience.

To specify:
Please refer to pages 3-5 for complete specifying information.
Specify all products by their product code.

M2 STACKING BAR CHAIR
Design: Martin Ballendat

M2S10



M2 Stacking Bar Chair	MODEL	FRAME FINISH	LIST PRICE
Standard shell	M2BS-S	Powder Coat	\$943
W 21.5 D 22 H 41.5 SH 29.5		Chrome	\$992

Optional Glides: Add \$8.00 net per chair for a set of four (4).



M2 Stacking Bar Chair	MODEL	LIST PRICE/GRADE	COM/ COL	A	B	C	D	E	F	G	H	I	J	K	L
Standard shell, upholstered seat onlay	M2BSU-S	Powder Coat	\$1029	1077	1101	1125	1149	1174	1197	1223	1247	1272	1296	1320	1346
		Chrome	\$1081	1128	1154	1178	1204	1227	1252	1276	1300	1324	1349	1372	1398

W 21.5 D 22 H 41.5 SH 30.5

Optional Glides: Add \$8.00 net per chair for a set of four (4). Optional Glides raise chair height .5 inch.
COM Yardage: 1 to 4 Seats: 1.5 yards
Contact Leland Customer Experience for yardage requirements on textiles with repeats.
For COL requirements please contact Leland Customer Experience.



M2 Stacking Bar Chair	MODEL	FRAME FINISH	LIST PRICE
Walnut shell	M2BS-W	Powder Coat	\$1081
W 21.5 D 22 H 41.5 SH 29.5		Chrome	\$1049

Optional Glides: Add \$8.00 net per chair for a set of four (4). Optional Glides raise chair height .5 inch.



M2 Stacking Bar Chair	MODEL	LIST PRICE/GRADE	COM/ COL	A	B	C	D	E	F	G	H	I	J	K	L
Walnut shell, upholstered seat onlay	M2BSU-W	Powder Coat	\$1116	1163	1188	1212	1238	1260	1286	1311	1335	1360	1384	1409	1432
		Chrome	\$1167	1215	1240	1264	1289	1314	1337	1362	1386	1411	1434	1459	1484

W 21.5 D 22 H 41.5 SH 30.5

Optional Glides: Add \$8.00 net per chair for a set of four (4). Optional Glides raise chair height .5 inch.
COM Yardage: 1 to 4 Seats: 1.5 yards
Contact Leland Customer Experience for yardage requirements on textiles with repeats.
For COL requirements please contact Leland Customer Experience.

To specify:
Please refer to pages 3-5 for complete specifying information.
Specify all products by their product code.



**M2 Chair Transport/
Stacking Dolly**

	MODEL	FRAME FINISH	LIST PRICE
W 23 D 33 H 6 (empty)	M2D	Powder Coat	\$1340

To specify:
Please refer to pages 3-5 for
complete specifying information.
Specify all products by their
product code.

Pricing Effective: January 2024

5695 Eagle Drive, SE
Grand Rapids,
Michigan 49512
616-975-9260
lelandfurniture.com

M3 Table

January 2024 Price List



M3 Table

Table of Contents	M3T2
Soft Square Pedestal Table Base Visual Reference	M3T4
Soft Square Counter & Bar Base Visual Reference	M3T5
Circle Pedestal Table Base Visual Reference	M3T6
Circle Counter & Bar Table Base Visual Reference	M3T7
Specification Information	M38
Specification Example	M3T10
Small Soft Square Base	M3T11
Medium Soft Square Base	M3T12
Large Soft Square Base	M3T13
Extra Large Soft Square Base	M3T14
Small Soft Square Counter Base	M3T15
Large Soft Square Counter Base	M3T16
Small Soft Square Bar Base	M3T17
Large Soft Square Bar Base	M3T18
Extra Small Circle Base	M3T19
Small Circle Base	M3T20
Medium Circle Base	M3T21
Large Circle Base	M3T22
Extra Large Circle Base	M3T23
Extra-Extra Large Circle Base	M3T24
Extra Small Circle Counter Base	M3T25
Small Circle Counter Base	M3T26
Medium Circle Counter Base	M3T27

M3 Table

Extra Small Circle Bar Base	M3T28
Small Circle Bar Base	M3T29
Large Circle Bar Base	M3T30













TABLE MODEL	TABLE TOP SIZES			BASE	COLUMN/BASE	PAGE
Small Soft Square Pedestal Table Base	 24 DIA 30 DIA	 24 x 24 30 x 30	 24 x 30	18" Soft Square	Powder Coat/Powder Coat	Page M3T11
						
Medium Soft Square Pedestal Table Base	 36 DIA	 36 x 36		20" Soft Square	Powder Coat/Powder Coat	Page M3T12
						
Large Soft Square Pedestal Table Base	 42 DIA	 42 x 42		22" Soft Square	Powder Coat/Powder Coat	Page M3T13
						
Extra Large Soft Square Pedestal Table Base	 48 DIA	 48 x 48		24" Soft Square	Powder Coat/Powder Coat	Page M3T14
						





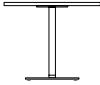

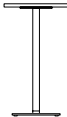



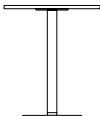

TABLE MODEL	TABLE TOP SIZES			BASE	COLUMN/BASE	PAGE
Small Soft Square Counter Table Base	Round	Square	Rectangle	18" Soft Square	Powder Coat/Powder Coat	Page M3T15
	 24 DIA 30 DIA	 24 x 24 30 x 30	 24 x 30			
Large Soft Square Counter Table Base	Round	Square		24" Soft Square	Powder Coat/Powder Coat	Page M3T16
	 36 DIA	 36 x 36				
Small Soft Square Bar Table Base	Round	Square	Rectangle	18" Soft Square	Powder Coat/Powder Coat	Page M3T17
	 24 DIA 30 DIA	 24 x 24 30 x 30	 24 x 30			
Large Soft Square Bar Table Base	Round	Square		24" Soft Square	Powder Coat/Powder Coat	Page M3T18
	 36 DIA	 36 x 36				







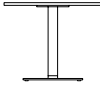







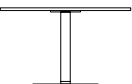

TABLE MODEL	TABLE TOP SIZES		BASE	COLUMN/BASE	PAGE
Extra Small Circle Pedestal Table Base 	Round 24 DIA 	Square 24 x 24 	18"-Diameter	Powder Coat/Powder Coat	Page M3T19
Small Circle Pedestal Table Base 	Round 30 DIA 	Rectangle 24 x 30 	20"-Diameter	Powder Coat/Powder Coat	Page M3T20
Medium Circle Pedestal Table Base 	Round 36 DIA 	Square 30 x 30 	22"-Diameter	Powder Coat/Powder Coat	Page M3T21
Large Circle Pedestal Table Base 	Round 42 DIA 	Square 36 x 36 	26"-Diameter	Powder Coat/Powder Coat	Page M3T22
Extra Large Circle Pedestal Table Base 	Round 48 DIA 	Square 42 x 42 	28"-Diameter	Powder Coat/Powder Coat	Page M3T23
Extra-Extra Large Circle Pedestal Table Base 		Square 48 x 48 	30"-Diameter	Powder Coat/Powder Coat	Page M3T24



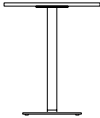



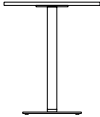

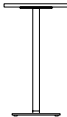

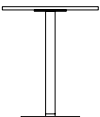



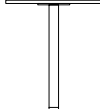

TABLE MODEL	TABLE TOP SIZES			BASE	COLUMN/BASE	PAGE
Extra Small Circle Counter Table Base 	Round  24 DIA			18"-Diameter	Powder Coat/Powder Coat	Page M3T25
Small Circle Counter Table Base 	Round  30 DIA	Square  24 x 24	Rectangle  24 x 30	20"-Diameter	Powder Coat/Powder Coat	Page M3T26
Medium Circle Counter Table Base 	Round  36 DIA	Square  30 x 30		22"-Diameter	Powder Coat/Powder Coat	Page M3T27
Extra Small Circle Bar Table Base 	Round  24 DIA			18"-Diameter	Powder Coat/Powder Coat	Page M3T28
Small Circle Bar Table Base 	Round  30 DIA	Square  24 x 24	Rectangle  24 x 30	20"-Diameter	Powder Coat/Powder Coat	Page M3T29
Medium Circle Bar Table Base 	Round  36 DIA	Square  30 x 30		22"-Diameter	Powder Coat/Powder Coat	Page M3T30

Table Model

DESCRIPTION	CODE
M3 pedestal table, small soft square base	M3SB
M3 pedestal table, medium soft square base	M3MB
M3 pedestal table, large soft square base	M3LB
M3 pedestal table, extra large soft square base	M3XLB
M3 pedestal table, small counter soft square base	M3SCB
M3 pedestal table, large counter soft square base	M3LCB
M3 pedestal table, small bar soft square base	M3SBB
M3 pedestal table, large bar soft square base	M3LBB
M3 pedestal table, extra large circle base	M3CXSB
M3 pedestal table, small circle base	M3CSB
M3 pedestal table, medium circle base	M3CMB
M3 pedestal table, large circle base	M3CLB
M3 pedestal table, extra large circle base	M3CXLB
M3 pedestal table, extra-extra large circle base	M3CXLB
M3 pedestal table, extra small counter circle base	M3CXSCB
M3 pedestal table, small bar circle base	M3CSCB
M3 pedestal table, medium bar circle base	M3CMCB
M3 pedestal table, extra small bar circle base	M3CXSB
M3 pedestal table, small bar circle base	M3CSBB
M3 pedestal table, medium bar circle base	M3CMBB

Base Finish: Powder Coat

DESCRIPTION	CODE
Black Textured	BT
White Textured	WT
Sterling	ST
Matte Mercury	MMR
Matte Mineral	MMN
Matte Burnish	MBN
Matte Foundry	MFN
Matte Blue Sky	MBS
Matte Forest	MFO
Matte Sienna	MSN
Matte Willow	MWL

Top Sizes

ROUND	CODE	SQUARE	CODE	RECTANGLE	CODE
24 DIA	24D	24x24	2424	24x30	2430
30 DIA	30D	30x30	3030		
36 DIA	36D	36x36	3636		
42 DIA	42D	2x42	4242		
48 DIA	48D	48x48	4848		

Top Finish or Color

WOOD TOPS:

STANDARD LELAND COLORS

CUSTOM SPECIFY custom (01)

*Please note that M3 Tables are NOT AVAILABLE in the following finishes:
Natural Walnut Matte (08M), Natural Beech (09), Natural White Oak Matte (12M)

LAMINATE TOPS:

DESCRIPTION	CODE
Grey Laminate Slate Grey Wilsonart®	LGY
Black Laminate Black Pionite®	LBK
White Laminate Designer White Wilsonart®	LWH

Please refer to the Leland Terms and Conditions Guide for a listing of standard laminates.
For table pricing in laminates not listed, please contact Leland's Customer Experience Department for a quotation.

FORBO

DESCRIPTION	CODE
Pearl	4157
Mauve	4172
Pebble	4175
Smokey Blue	4179
Olive	4184

Edge finish options: natural (11) plywood (W2)

Edge Type

VINYL EDGES:

DESCRIPTION	CODE
¾" flat PVC	V5

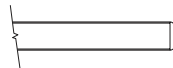

WOOD EDGES:

DESCRIPTION	CODE
1" beveled plywood	W6

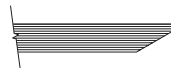

1" flat plywood	W2
-----------------	----



Edge Finish or Color

VINYL EDGE COLORS:

DESCRIPTION	CODE
Black	B
White	W
Grey	G

WOOD EDGE COLORS:

STANDARD LELAND COLORS

CUSTOM SPECIFY Custom (01)

*Please note that M3 Tables are NOT AVAILABLE in the following finishes:
Natural Walnut Matte (08M), Natural Beech (09), Natural White Oak Matte (12M)

For laminate tops, edge can be specified in any standard Leland finish. Wood tops and edges must be specified in the same standard Leland finish.

Specifications required to create the product code

- Model
- Base Column Finish
- Base Plate Finish
- Top Size
- Top Finish Or Color
- Edge Type
- Edge Finish Or Color



MODEL

M3 Pedestal Table,
Medium Circle Base (M3CMB)

BASE CENTER

White Textured (WT)

TOP SIZE

42" Diameter (42D)

TOP COLOR OR FINISH

White Laminate (LWH)

EDGE TYPE

1" Flat Plywood (W2)

EDGE FINISH OR COLOR

Natural Maple (11)





M3 PEDESTAL TABLE, SMALL SOFT SQUARE BASE
 Design: Leland Design Group

M3T11



**M3 Pedestal Table,
 Powder Coat Base**

	MODEL	TOP SIZE/CODE	LIST PRICE/EDGE CODES:	V5	W6	W2
Small soft square	M3SB-P-P	Wood Top				
		24 DIA - 24D		\$1579	1949	1949
H 29		30 DIA - 30D		\$2058	2637	2637
		24x24 - 2424		\$1579	1949	1949
Round	Square	Rectangle				
24 DIA	24 x 24	24 x 30				
30 DIA	30 x 30					
		Laminate Top				
		24 DIA - 24D		\$1409	1716	1716
		30 DIA - 30D		\$1817	2302	2302
		24x24 - 2424		\$1409	1714	1714
		30x30 - 3030		\$1817	2302	2302
		24x30 - 2430		\$1903	2318	2318
		Forbo Top				
		24 DIA - 24D			\$2044	2044
		30 DIA - 30D			\$2452	2452
		24x24 - 2424			\$2044	2044
		30x30 - 3030			\$2452	2452
		24x30 - 2430			\$2538	2538

To specify:
 Please refer to pages 6-8 for complete specifying information.
 Specify all products by their product code.

M3 PEDESTAL TABLE, MEDIUM SOFT SQUARE BASE
 Design: Leland Design Group

M3T12



**M3 Pedestal Table,
 Powder Coat Base**

	MODEL	TOP SIZE/CODE	LIST PRICE/EDGE CODES:	V5	W6	W2
Medium soft square	M3MB-P-P	Wood Top				
		36 DIA - 36D		\$2172	2749	2749
H 29		36x36 - 3636		\$2172	2749	2749
		Laminate Top				
Round		36 DIA - 36D		\$1914	2399	2399
36 DIA		36x36 - 3636		\$1914	2399	2399
Square		Forbo Top				
		36 DIA - 36D			\$2549	2549
		36x36 - 3636			\$2549	2549

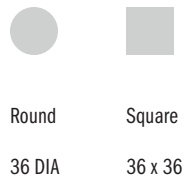

To specify:
 Please refer to pages 6-8 for complete specifying information.
 Specify all products by their product code.



Pricing Effective: January 2024

M3 PEDESTAL TABLE, LARGE SOFT SQUARE BASE
 Design: Leland Design Group

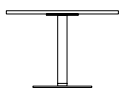
M3T13



**M3 Pedestal Table,
 Powder Coat Base**

	MODEL	TOP SIZE/CODE	LIST PRICE/EDGE CODES:	V5	W6	W2
Large soft square	M3LB-P-P	Wood Top				
		42 DIA - 42D		\$2975	3553	3553
H 29		42x42 - 4242		\$2975	3553	3553
 		Laminate Top				
Round	Square	42 DIA - 42D		\$2596	3080	3080
42 DIA	42 x 42	42x42 - 4242		\$2596	3080	3080
		Forbo Top				
		42 DIA - 42D			\$3548	3548
		42x42 - 4242			\$3548	3548

To specify:
 Please refer to pages 6-8 for complete specifying information.
 Specify all products by their product code.

M3 PEDESTAL TABLE, EXTRA LARGE SOFT SQUARE BASE
 Design: Leland Design Group

M3T14



**M3 Pedestal Table,
 Powder Coat Base**

	MODEL	TOP SIZE/CODE	LIST PRICE/EDGE CODES:	V5	W6	W2
Extra Large soft square	M3XLB-P-P	Wood Top				
		48 DIA - 48D		\$3096	3616	3553
H 29		48x48 - 4848		\$3038	3616	3553
		Laminate Top				
Round	Square	48 DIA - 48D		\$2646	3131	3131
48 DIA	48 x 48	48x48 - 4848		\$2646	3131	3131
		Forbo Top				
		48 DIA - 48D			\$4084	4084
		48x48 - 4848			\$4084	4084



Round Square
 48 DIA 48 x 48

To specify:
 Please refer to pages 6-8 for complete specifying information.
 Specify all products by their product code.



Pricing Effective: January 2024

M3 PEDESTAL TABLE, SMALL SOFT SQUARE COUNTER BASE
 Design: Leland Design Group

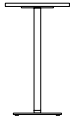
M3T15



**M3 Pedestal Table,
 Powder Coat Base**

	MODEL	TOP SIZE/CODE	LIST PRICE/EDGE CODES:	V5	W6	W2
Small soft square counter	M3SCB-P-P	Wood Top				
		24 DIA - 24D		\$1650	2021	2021
H 36		30 DIA - 30D		\$2132	2709	2709
		24x24 - 2424		\$1650	2021	2021
Round	Square	30x30 - 3030		\$2132	2709	2709
		24x30 - 2430		\$1864	2352	2352
24 DIA	24 x 24					
30 DIA	30 x 30					
		Laminate Top				
		24 DIA - 24D		\$1488	1795	1795
		30 DIA - 30D		\$1897	2382	2382
		24x24 - 2424		\$1488	1795	1795
		30x30 - 3030		\$1897	2382	2382
		24x30 - 2430		\$1982	2396	2396
		Forbo Top				
		24 DIA - 24D			\$2160	2160
		30 DIA - 30D			\$2569	2569
		24x24 - 2424			\$2160	2160
		30x30 - 3030			\$2569	2569
		24x30 - 2430			\$2666	2666

To specify:
 Please refer to pages 6-8 for complete specifying information.
 Specify all products by their product code.

M3 PEDESTAL TABLE, LARGE SOFT SQUARE COUNTER BASE
 Design: Leland Design Group

M3T16

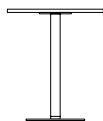

M3 Pedestal Table,

Powder Coat Base

	MODEL	TOP SIZE/CODE	LIST PRICE/EDGE CODES:	V5	W6	W2
Large soft square counter	M3LCB-P-P	Wood Top				
		36 DIA - 36D		\$2238	2822	2822
H 36		36x36 - 3636		\$2238	2822	2822
		Laminate Top				
Round	Square	36 DIA - 36D		\$1991	2476	2476
36 DIA	36 x 36	36x36 - 3636		\$1991	2476	2476
		Forbo Top				
		36 DIA - 36D			\$2665	2665
		36x36 - 3636			\$2665	2665



Round

Square

36 DIA

36 x 36

To specify:

Please refer to pages 6-8 for complete specifying information.

Specify all products by their product code.



Pricing Effective: January 2024

M3 PEDESTAL TABLE, SMALL SOFT SQUARE BAR BASE
 Design: Leland Design Group

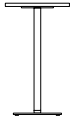
M3T17



**M3 Pedestal Table,
 Powder Coat Base**

	MODEL	TOP SIZE/CODE	LIST PRICE/EDGE CODES:	V5	W6	W2
Small soft square bar	M3SBB-P-P	Wood Top				
		24 DIA - 24D		\$1720	2091	2091
H 42		30 DIA - 30D		\$2201	2780	2780
		24x24 - 2424		\$1720	2091	2091
Round	Square	Rectangle				
24 DIA	24 x 24	24 x 30				
30 DIA	30 x 30					
		Laminate Top				
		24 DIA - 24D		\$1551	1859	1859
		30 DIA - 30D		\$1961	2446	2446
		24x24 - 2424		\$1551	1859	1859
		30x30 - 3030		\$1961	2446	2446
		24x30 - 2430		\$2045	2460	2460
		Forbo Top				
		24 DIA - 24D			\$2186	2186
		30 DIA - 30D			\$2595	2595
		24x24 - 2424			\$2186	2186
		30x30 - 3030			\$2595	2595
		24x30 - 2430			\$2692	2692



To specify:
 Please refer to pages 6-8 for complete specifying information.
 Specify all products by their product code.

M3 PEDESTAL TABLE, LARGE SOFT SQUARE BAR BASE
 Design: Leland Design Group

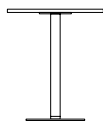
M3T18



**M3 Pedestal Table,
 Powder Coat Base**

	MODEL	TOP SIZE/CODE	LIST PRICE/EDGE CODES:	V5	W6	W2
Large soft square bar	M3LBB-P-P	Wood Top				
		36 DIA - 36D		\$2314	2892	2892
H 42		36x36 - 3636		\$2314	2892	2892
		Laminate Top				
Round	Square	36 DIA - 36D		\$2055	2540	2540
36 DIA	36 x 36	36x36 - 3636		\$2055	2540	2540
		Forbo Top				
		36 DIA - 36D			\$2691	2691
		36x36 - 3636			\$2691	2691

To specify:
 Please refer to pages 6-8 for complete specifying information.
 Specify all products by their product code.



Pricing Effective: January 2024

M3 PEDESTAL TABLE, EXTRA SMALL CIRCLE BASE
 Design: Leland Design Group

M3T19



**M3 Pedestal Table,
 Powder Coat Base**

	MODEL	TOP SIZE/CODE	LIST PRICE/EDGE CODES:	V5	W6	W2
Extra small circle	M3CXSB-P-P	Wood Top				
		24 DIA - 24D		\$1579	1949	1949
H 29		24x24 - 2424		\$1579	1949	1949
		Laminate Top				
Round	Square	24 DIA - 24D		\$1409	1716	1716
24 DIA	24 x 24	24x24 - 2424		\$1409	1716	1716
		Forbo Top				
		24 DIA - 24D			\$2044	2044
		24x24 - 2424			\$2044	2044

To specify:
 Please refer to pages 6-8 for complete specifying information.
 Specify all products by their product code.

M3 PEDESTAL TABLE, SMALL CIRCLE BASE
 Design: Leland Design Group

M3T20



**M3 Pedestal Table,
 Powder Coat Base**

	MODEL	TOP SIZE/CODE	LIST PRICE/EDGE CODES:	V5	W6	W2
Small circle	M3CSB-P-P	Wood Top				
		30 DIA - 30D		\$2058	2637	2637
H 29		24x30 - 2430		\$1787	2280	2280
		Laminate Top				
Round		30 DIA - 30D		\$1817	2302	2302
30 DIA		24x30 - 2430		\$1903	2318	2318
Rectangle		Forbo Top				
		30 DIA - 30D			\$2452	2452
		24x30 - 2430			\$2538	2538



Round Rectangle

30 DIA 24 x 30

To specify:
 Please refer to pages 6-8 for complete specifying information.
 Specify all products by their product code.

Pricing Effective: January 2024

M3 PEDESTAL TABLE, MEDIUM CIRCLE BASE
 Design: Leland Design Group

M3T21

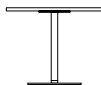

**M3 Pedestal Table,
 Powder Coat Base**

	MODEL	TOP SIZE/CODE	LIST PRICE/EDGE CODES:	V5	W6	W2
Medium circle	M3CMB-P-P	Wood Top				
		36 DIA - 36D		\$2172	2749	2749
H 29		30x30 - 3030		\$2058	2637	2637
		Laminate Top				
Round	Square	36 DIA - 36D		\$1914	2399	2399
36 DIA	30 x 30	30x30 - 3030		\$1817	2302	2302
		Forbo Top				
		36 DIA - 36D			\$2549	2549
		30x30 - 3030			\$2452	2452



Round

Square

36 DIA

30 x 30

To specify:

Please refer to pages 6-8 for complete specifying information.

Specify all products by their product code.



Pricing Effective: January 2024

M3 PEDESTAL TABLE, LARGE CIRCLE BASE
 Design: Leland Design Group

M3T22



**M3 Pedestal Table,
 Powder Coat Base**

	MODEL	TOP SIZE/CODE	LIST PRICE/EDGE CODES:	V5	W6	W2
Large circle	M3CLB-P-P	Wood Top				
		42 DIA - 42D		\$2975	3553	3553
H 29		36x36 - 3636		\$2172	2749	2749
		Laminate Top				
Round	Square	42 DIA - 42D		\$2596	3080	3080
42 DIA	36 x 36	36x36 - 3636		\$1914	2399	2399
		Forbo Top				
		42 DIA - 42D			\$3548	3548
		36x36 - 3636			\$2549	2549

To specify:
 Please refer to pages 6-8 for complete specifying information.
 Specify all products by their product code.

Pricing Effective: January 2024

M3 PEDESTAL TABLE, EXTRA LARGE CIRCLE BASE
 Design: Leland Design Group

M3T23

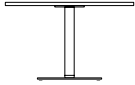

**M3 Pedestal Table,
 Powder Coat Base**

	MODEL	TOP SIZE/CODE	LIST PRICE/EDGE CODES:	V5	W6	W2
Extra large circle	M3CXLB-P-P	Wood Top				
		48 DIA - 48D		\$3096	3616	3553
H 29		42x42 - 4242		\$2975	3553	3553
		Laminate Top				
Round		48 DIA - 48D		\$2646	3131	3131
48 DIA		42x42 - 4242		\$2596	3080	3080
Square		42x42 - 4242				
		Forbo Top				
		48 DIA - 48D			\$3600	3600
		42x42 - 4242			\$3548	3548



Round Square

48 DIA 42 x 42

To specify:
 Please refer to pages 6-8 for complete specifying information.
 Specify all products by their product code.

Pricing Effective: January 2024

M3 PEDESTAL TABLE, EXTRA-EXTRA LARGE CIRCLE BASE
 Design: Leland Design Group

M3T24

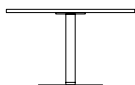

**M3 Pedestal Table,
 Powder Coat Base**

	MODEL	TOP SIZE/CODE	LIST PRICE/EDGE CODES:	V5	W6	W2
Extra-extra large circle	M3CXXLB-P-P	Wood Top				
		48x48 - 4848		\$3038	3616	3553
H 29		Laminate Top				
		48x48 - 4848		\$2646	3131	3131
Square		Forbo Top				
48 x 48		48x48 - 4848			\$3600	3600

To specify:
 Please refer to pages 6-8 for complete specifying information.
 Specify all products by their product code.

Pricing Effective: January 2024

M3 PEDESTAL TABLE, EXTRA SMALL CIRCLE
COUNTER BASE

Design: Leland Design Group

M3T25

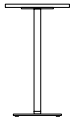

**M3 Pedestal Table,
Powder Coat Base**

	MODEL	TOP SIZE/CODE	LIST PRICE/EDGE CODES:	V5	W6	W2
Extra small circle counter	M3CXSCB-P-P	Wood Top				
		24 DIA - 24D		\$1650	2021	2021
H 36		Laminate Top				
		24 DIA - 24D		\$1488	1795	1795
Circle		Forbo Top				
		24 DIA - 24D			\$2160	2160



Circle

24 DIA

To specify:

Please refer to pages 6-8 for complete specifying information.

Specify all products by their product code.



Pricing Effective: January 2024

M3 PEDESTAL TABLE, SMALL CIRCLE COUNTER BASE
 Design: Leland Design Group

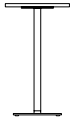
M3T26



**M3 Pedestal Table,
 Powder Coat Base**

	MODEL	TOP SIZE/CODE	LIST PRICE/EDGE CODES:	V5	W6	W2
Small circle counter	M3CSCB-P-P	Wood Top				
		30 DIA - 30D		\$2132	2709	2709
H 36		24x24 - 2424		\$1650	2021	2021
		24x30 - 2430		\$1864	2352	2352
  		Laminate Top				
Round		30 DIA - 30D		\$1897	2382	2382
Square		24x24 - 2424		\$1488	1795	1795
Rectangle		24x30 - 2430		\$1982	2396	2396
30 DIA		Forbo Top				
		30 DIA - 30D			\$2569	2569
		24x24 - 2424			\$2160	2160
		24x30 - 2430			\$2666	2666

To specify:
 Please refer to pages 6-8 for complete specifying information.
 Specify all products by their product code.

M3 PEDESTAL TABLE, MEDIUM CIRCLE COUNTER BASE
 Design: Leland Design Group

M3T27

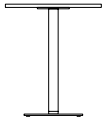

**M3 Pedestal Table,
 Powder Coat Base**

	MODEL	TOP SIZE/CODE	LIST PRICE/EDGE CODES:	V5	W6	W2
Medium circle counter	M3CMCB-P-P	Wood Top				
		30X30 - 3030		\$2132	2709	2709
H 36		Laminate Top				
		30X30 - 3030		\$1897	2382	2382
Square		Forbo Top				
30 x 30		30X30 - 3030			\$2569	2569

To specify:
 Please refer to pages 6-8 for complete specifying information.
 Specify all products by their product code.

Pricing Effective: January 2024

M3 PEDESTAL TABLE, EXTRA SMALL CIRCLE BAR BASE
 Design: Leland Design Group

M3T28



**M3 Pedestal Table,
 Powder Coat Base**

	MODEL	TOP SIZE/CODE	LIST PRICE/EDGE CODES:	V5	W6	W2
Extra small circle bar	M3CXSBB-P-P	Wood Top				
		24 DIA - 24D		\$1720	2091	2091
H 42		Laminate Top				
		24 DIA - 24D		\$1551	1859	1859
Circle		Forbo Top				
24 DIA		24 DIA - 24D			\$2186	2186



To specify:
 Please refer to pages 6-8 for complete specifying information.
 Specify all products by their product code.

M3 PEDESTAL TABLE, SMALL CIRCLE BAR BASE
 Design: Leland Design Group

M3T29



**M3 Pedestal Table,
 Powder Coat Base**

	MODEL	TOP SIZE/CODE	LIST PRICE/EDGE CODES:	V5	W6	W2
Small circle bar	M3CSBB-P-P	Wood Top				
		30 DIA - 30D		\$2201	2780	2780
H 42		24x24 - 2424		\$1720	2091	2091
		24x30 - 2430		\$1928	2423	2423
  		Laminate Top				
Round		30 DIA - 30D		\$1961	2446	2446
30 DIA		24x24 - 2424		\$1551	1859	1859
Square		24x30 - 2430		\$2045	2460	2460
24 x 24		Forbo Top				
Rectangle		30 DIA - 30D			\$2595	2595
24 x 30		24x24 - 2424			\$2186	2186
		24x30 - 2430			\$2692	2692

To specify:
 Please refer to pages 6-8 for complete specifying information.
 Specify all products by their product code.

M3 PEDESTAL TABLE, MEDIUM CIRCLE BAR BASE
 Design: Leland Design Group

M3T30

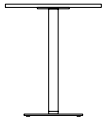

**M3 Pedestal Table,
 Powder Coat Base**

	MODEL	TOP SIZE/CODE	LIST PRICE/EDGE CODES:	V5	W6	W2
Medium circle bar	M3CMBB-P-P	Wood Top				
		30X30 - 3030		\$2201	2780	2780
H 42		Laminate Top				
		30X30 - 3030		\$1961	2446	2446
Square		Forbo Top				
30 x 30		30X30 - 3030			\$2595	2595

To specify:
 Please refer to pages 6-8 for complete specifying information.
 Specify all products by their product code.

Pricing Effective: January 2024

**5695 Eagle Drive, SE
Grand Rapids,
Michigan 49512
616-975-9260
lelandfurniture.com**

Marquette Seating

January 2024 Price List



Marquette Seating

Table of Contents	MQ2
Specification Information	MQ3
Specification Example	MQ4
Stacking Side Chair, Sled Base	MQ5
Counter Chair, Sled Base	MQ6
Bar Chair, Sled Base	MQ7
Marquette Transport/Stacking Dolly	MQ8

Chair Model

SLED BASE:

DESCRIPTION	CODE
Marquette side chair	MQS
Marquette side chair, upholstered seat	MQSU
Marquette counter chair	MQC
Marquette counter chair, upholstered seat	MQCU
Marquette bar chair	MQB
Marquette bar chair, upholstered seat	MQBU

Shell Finish

STANDARD LELAND COLORS

CUSTOM SPECIFY Custom (01)







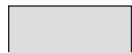







*Please note that Marquette Chair is NOT AVAILABLE in the following finishes:
 Natural Walnut Matte (08M), Natural Beech (09), Natural White Oak Matte (12M)

Shell Style

SHELL	CODE	SHELL	CODE
Linear	L	Arc	A



Back Cut Out

LINEAR CUT OUTS	CODE	ARC CUT OUTS	CODE
Plain back	1	Plain back	1
Circle 	2	Circle 	2
Diamond 	4	Diamond 	4
Grid 	5	Grid 	5
Perforated 	3	Slotted 	6
Dots 	10	Dots 	10
Squares 	11	Reeds 	13
Reeds 	13	Mosaic 	15
Custom cut out	00	Custom cut out	00

Frame Finish

DESCRIPTION	CODE
Sterling	ST
Black	B
White	W
Warm Grey	WG
Cool Grey	CG
Chrome	C
Matte Blue Sky	MBS
Matte Forest	MFO
Matte Sienna	MSN
Matte Willow	MWL

TEXTURED	CODE
Dolphin Textured	DLT
Oxford Textured	OXT
Black Textured	BT
White Textured	WT

Upholstery Selection

Please refer to Leland Textile Program which features textiles and leathers from the following partners:

- Camira
- Green Hides
- Carnegie
- Maharam
- CF Stinson
- Unika Vaev

The complete grade list can be found on our website or you can specify COM/COL. Due to the design of this product, it is recommended that all non pre-approved textile be tested for compatibility.

Glide Type

STANDARD:	DESCRIPTION	CODE
	Poly	S
OPTIONAL:	DESCRIPTION	CODE
	Felt	F

Specifications required to create the product code

- Model
- Shell Style
- Back Cut Out
- Shell Finish
- Frame Finish
- Upholstery selection (when applicable)
- Glide Type



MODEL

Marquette Side Chair,
Upholstered Seat, Sled Base (MQSU)

SHELL STYLE

Linear (L)

BACK CUT OUT

Grid (5)

SHELL FINISH

Natural (11)

FRAME FINISH

Chrome (C)

UPHOLSTERY

When applicable:
Upholstery— Enter Leland textile code or COM/COL

GLIDE TYPE

Standard Felt (F)



MARQUETTE STACKING SIDE CHAIR, SLED BASE
 Design: Leland Design Group

MQ5

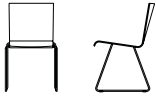

Marquette Side Chair	MODEL	FRAME FINISH	LIST PRICE
Sled base, linear shell	MQS-L	Powder Coat	\$322
W 19.75 D 21 H 34 SH 18.5		Chrome	\$377

Optional Glides: Add \$8.00 net per chair for a set of four (4).

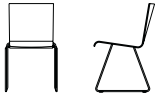

Marquette Side Chair	MODEL	LIST PRICE/GRADE	COM/COL	A	B	C	D	E	F	G	H	I	J	K	L
Sled base, linear shell upholstered seat onlay	MQSU-L	Powder Coat	\$416	441	455	468	482	495	506	520	533	545	559	570	583
		Chrome	\$473	500	513	526	538	551	565	578	591	603	615	629	642

W 19.75 D 21 H 34 SH 18.75

COM Yardage: 1-2 seats: .75 yard; 3-4 seats: 1.25 yards; 5-6 seats: 1.75 yards
 Contact Leland Customer Service for yardage requirements on textiles with repeats.
 For COL requirements please contact Leland Customer Experience.



Marquette Side Chair	MODEL	FRAME FINISH	LIST PRICE
Sled base, arc shell	MQS-A	Powder Coat	\$322
W 19.75 D 21 H 34 SH 18.5		Chrome	\$377

Optional Glides: Add \$8.00 net per chair for a set of four (4).



Marquette Side Chair	MODEL	LIST PRICE/GRADE	COM/COL	A	B	C	D	E	F	G	H	I	J	K	L
Sled base, arc shell upholstered seat onlay	MQSU-A	Powder Coat	\$416	441	455	468	482	495	506	520	533	545	559	570	583
		Chrome	\$473	500	513	526	538	551	565	578	591	603	615	629	642

W 19.75 D 21 H 34 SH 18.75

COM Yardage: 1-2 seats: .75 yard; 3-4 seats: 1.25 yards; 5-6 seats: 1.75 yards
 Contact Leland Customer Service for yardage requirements on textiles with repeats.
 For COL requirements please contact Leland Customer Experience.

To specify:
 Please refer to pages 3-5 for complete specifying information.
 Specify all products by their product code.

Pricing Effective: January 2024

MARQUETTE COUNTER CHAIR, SLED BASE
Design: Leland Design Group

MQ6

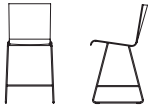

Marquette Counter Chair	MODEL	FRAME FINISH	LIST PRICE
Sled base, linear shell W 19.25 D 22.5 H 39.75 SH 25.25	MQC-L	Powder Coat	\$641
		Chrome	\$717

Optional Glides: Add \$8.00 net per chair for a set of four (4). Optional Glides raise chair height .5 inch.

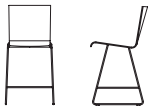

Marquette Counter Chair	MODEL	LIST PRICE/GRADE	COM/COL	A	B	C	D	E	F	G	H	I	J	K	L
Sled base, linear shell upholstered seat onlay W 19.25 D 22.5 H 39.75 SH 25.5	MQCU-L	Powder Coat	\$742	771	783	797	809	821	834	847	861	873	885	898	912
		Chrome	\$819	846	860	872	884	897	910	924	937	949	961	975	988

COM Yardage: 1-2 seats: .75 yard; 3-4 seats: 1.25 yards; 5-6 seats: 1.75 yards
Contact Leland Customer Service for yardage requirements on textiles with repeats.
For COL requirements please contact Leland Customer Experience.

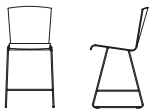

Marquette Counter Chair	MODEL	FRAME FINISH	LIST PRICE
Sled base, arc shell W 19.25 D 22.5 H 39.75 SH 25.25	MQC-A	Powder Coat	\$641
		Chrome	\$717

Optional Glides: Add \$8.00 net per chair for a set of four (4). Optional Glides raise chair height .5 inch.



Marquette Counter Chair	MODEL	LIST PRICE/GRADE	COM/COL	A	B	C	D	E	F	G	H	I	J	K	L
Sled base, arc shell upholstered seat onlay W 19.25 D 22.5 H 39.75 SH 25.5	MQCU-A	Powder Coat	\$742	771	783	797	809	821	834	847	861	873	885	898	912
		Chrome	\$819	846	860	872	884	897	910	924	937	949	961	975	988

COM Yardage: 1-2 seats: .75 yard; 3-4 seats: 1.25 yards; 5-6 seats: 1.75 yards
Contact Leland Customer Service for yardage requirements on textiles with repeats.
For COL requirements please contact Leland Customer Experience.

To specify:
Please refer to pages 3-5 for complete specifying information.
Specify all products by their product code.

Pricing Effective: January 2024

MARQUETTE BAR CHAIR, SLED BASE
 Design: Leland Design Group

MQ7

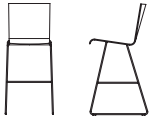

Marquette Bar Chair	MODEL	FRAME FINISH	LIST PRICE
sled base, linear shell W 19.5 D 23 H 44 SH 30.25	MQB-L	Powder Coat	\$657
		Chrome	\$750

Optional Glides: Add \$8.00 net per chair for a set of four (4). Optional Glides raise chair height .5 inch.

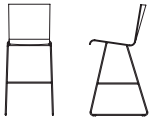

Marquette Bar Chair	MODEL	LIST PRICE/GRADE	COM/COL	A	B	C	D	E	F	G	H	I	J	K	L
Sled base, linear shell upholstered seat onlay W 19.5 D 23 H 44 SH 30.5	MQBU-L	Powder Coat	\$759	785	799	811	823	837	849	863	876	889	902	914	927
		Chrome	\$853	881	894	907	919	932	945	957	972	984	997	1010	1022

COM Yardage: 1-2 seats: .75 yard; 3-4 seats: 1.25 yards; 5-6 seats: 1.75 yards
 Contact Leland Customer Service for yardage requirements on textiles with repeats.
 For COL requirements please contact Leland Customer Experience.

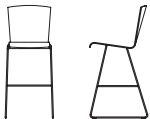

Marquette Bar Chair	MODEL	FRAME FINISH	LIST PRICE
Sled base, arc shell W 19.5 D 23 H 44 SH 30.25	MQB-A	Powder Coat	\$657
		Chrome	\$750

Optional Glides: Add \$8.00 net per chair for a set of four (4). Optional Glides raise chair height .5 inch.



Marquette Bar Chair	MODEL	LIST PRICE/ GRADE	COM/COL	A	B	C	D	E	F	G	H	I	J	K	L
Sled base, arc shell upholstered seat onlay W 19.5 D 23 H 44 SH 30.5	MQBU-A	Powder Coat	\$759	785	799	811	823	837	849	863	876	889	902	914	927
		Chrome	\$853	881	894	907	919	932	945	957	972	984	997	1010	1022

COM Yardage: 1-2 seats: .75 yard; 3-4 seats: 1.25 yards; 5-6 seats: 1.75 yards
 Contact Leland Customer Service for yardage requirements on textiles with repeats.
 For COL requirements please contact Leland Customer Experience.

To specify:
 Please refer to pages 3-5 for complete specifying information.
 Specify all products by their product code.

MARQUETTE TRANSPORT/STACKING DOLLY
 Design: Leland Design Group

MQ8

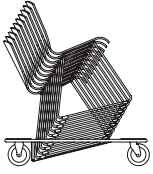

**Marquette Transport/
 Stacking Dolly**

	MODEL	FRAME FINISH	LIST PRICE
W 23 D 33 H 6 (empty)	MQD	Powder Coat	\$1146
W 23 D 33 H 38 (with 10 side chairs)		Marquette Transport/Stacking Dolly handles up to 10 Marquette side chairs. Little Marquette chairs do not stack on dolly.	

**PROPER STACKING OF MARQUETTE SLED BASE CHAIRS
 (10 CHAIRS MAXIMUM)**

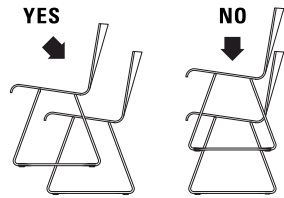

To specify:
 Please refer to pages 3-5 for complete specifying information.
 Specify all products by their product code.

Pricing Effective: January2024

**5695 Eagle Drive, SE
Grand Rapids,
Michigan 49512
616-975-9260
lelandfurniture.com**

Mass

January 2024 Price List



Mass

Table of Contents	MA2
Specification Information	MA3
Specification Example	MA4
Stacking Side Chair	MA5
Stacking Side Chair, Upholstered Seat	MA6
Stacking Arm Chair	MA7
Stacking Arm Chair, Upholstered Seat	MA8
Stacking Counter Chair	MA9
Stacking Counter Chair, Upholstered Seat	MA10
Stacking Bar Chair	MA11
Stacking Bar Chair, Upholstered Seat	MA12
Transport/Stacking Dolly	MA13
Ganging Device	MA13

Chair Model

DESCRIPTION	CODE
Mass stacking side chair	MASS
Mass stacking side chair, upholstered seat	MASSU
Mass stacking arm chair	MASA
Mass stacking arm chair, upholstered seat	MASAU
Mass stacking counter chair	MASC
Mass stacking counter chair, upholstered seat	MASCU
Mass stacking bar chair	MASB
Mass stacking bar chair, upholstered seat	MASBU
Mass transport/stacking dolly	MASD

Seat/Back Color

POLYPROPYLENE SHELL:

DESCRIPTION	CODE
White	WT
Recycled Black	RB
Dolphin	DL
Pistachio	PS
Fawn	FW

CUSTOM POLYPROPYLENE COLORS

Custom color match is available upon request. Please contact hello@lelandfurniture.com for further information

Onlay Selection

Please refer to Leland Textile Program which features textiles and leathers from the following partners:

- Camira
- Green Hides
- Carnegie
- Maharam
- CF Stinson
- Unika Vaev

The complete grade list can be found at www.lelandfurniture.com/resources or you can specify COM/COL. Due to the design of this product, it is recommended that all non pre-approved textile be tested for compatibility.

Frame Finish

DESCRIPTION	CODE
Chrome	C
Matte Fawn	MFW
Matte Pistachio	MPS
Sterling	ST
Dolphin Textured	DLT
White Textured	WT
Black Textured	BT
Black	B
White	W

Glide Type

STANDARD:

DESCRIPTION	CODE
Nylon	S

OPTIONAL:

DESCRIPTION	CODE
Felt	F

Stacking Note

Mass side chair, arm chair and bar chair models stack as follows (includes upholstered):

SIDE CHAIR:

Floor: 15 High
Dolly: 40 High

ARM CHAIR:

Floor: 12 High
Dolly: 40 High

BAR & COUNTER CHAIR:

Floor: 8 High

Chair Weight

SIDE CHAIR: 12 lbs

ARM CHAIR: 14 lbs

Specifications required to create the product code

- Model
- Shell Finish
- Upholstered Onlay Selection (when applicable)
- Frame Finish
- Glide or Caster Type

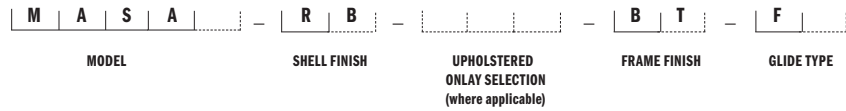

MODEL

Mass stacking arm chair (MASA)

SHELL FINISH

Recycled Black (RB)

UPHOLSTERED ONLAY SELECTION

When applicable, enter upholstery grade, COM



FRAME FINISH

Black Textured (BT)

GLIDE TYPE

Optional Felt (F)



MASS STACKING SIDE CHAIR
 Design: ITEMdesignworks, licensed by Sellex

MA5



PRICING FOR QUANTITIES 1-99

Mass Stacking Side Chair	MODEL	FRAME FINISH	LIST PRICE
Polypropylene shell	MASS	Powder Coat	\$375
W 20.5 D 20.5 H 32.25 SH 18		Chrome	\$440

Optional Glides: Add \$8.00 net per chair for a set of four (4).



PRICING FOR QUANTITIES 100-299

Mass Stacking Side Chair	MODEL	FRAME FINISH	LIST PRICE
Polypropylene shell	MASS	Powder Coat	\$359
W 20.5 D 20.5 H 32.25 SH 18		Chrome	\$416

Optional Glides: Add \$8.00 net per chair for a set of four (4).



PRICING FOR QUANTITIES 300+

Mass Stacking Side Chair	MODEL	FRAME FINISH	LIST PRICE
Polypropylene shell	MASS	Powder Coat	\$336
W 20.5 D 20.5 H 32.25 SH 18		Chrome	\$393

Optional Glides: Add \$8.00 net per chair for a set of four (4).

To specify:
 Please refer to pages 3-4 for complete specifying information.
 Specify all products by their product code.

Pricing Effective: January 2024

MASS STACKING SIDE CHAIR, UPHOLSTERED SEAT
 Design: ITEMdesignworks, licensed by Sellex

MA6



PRICING FOR QUANTITIES 1-99

Mass Stacking Side Chair

MODEL	LIST PRICE/GRADE	COM/COL	A	B	C	D	E	F	G	H	I	J	K	L
Polypropylene shell, upholstered seat onlay	Powder Coat	\$518	554	589	626	662	697	733	769	804	840	875	911	947
	Chrome	\$582	618	654	690	726	761	798	834	869	905	940	976	1012

W 20.5 D 20.5 H 32.25 SH 18

COM Yardage: 1-3 seats: .5 yard
 Contact Leland Customer Experience for yardage requirements on textiles with repeats.
 For COL requirements please contact Leland Customer Experience.
 Optional Glides: Add \$8.00 net per chair for a set of four (4).



PRICING FOR QUANTITIES 100-299

Mass Stacking Side Chair

MODEL	LIST PRICE/GRADE	COM/COL	A	B	C	D	E	F	G	H	I	J	K	L
Polypropylene shell, upholstered seat onlay	Powder Coat	\$488	524	560	596	631	667	702	738	774	809	845	882	917
	Chrome	\$548	585	621	656	692	729	764	800	836	871	907	943	978

W 20.5 D 20.5 H 32.25 SH 18

COM Yardage: 1-3 seats: .5 yard
 Contact Leland Customer Experience for yardage requirements on textiles with repeats.
 For COL requirements please contact Leland Customer Experience.
 Optional Glides: Add \$8.00 net per chair for a set of four (4).



PRICING FOR QUANTITIES 300+

Mass Stacking Side Chair

MODEL	LIST PRICE/GRADE	COM/COL	A	B	C	D	E	F	G	H	I	J	K	L
Polypropylene shell, upholstered seat onlay	Powder Coat	\$461	497	533	568	604	640	675	712	748	783	819	855	890
	Chrome	\$519	555	590	627	663	698	734	770	805	841	877	912	948

W 20.5 D 20.5 H 32.25 SH 18

COM Yardage: 1-3 seats: .5 yard
 Contact Leland Customer Experience for yardage requirements on textiles with repeats.
 For COL requirements please contact Leland Customer Experience.
 Optional Glides: Add \$8.00 net per chair for a set of four (4).

To specify:
 Please refer to pages 3-4 for complete specifying information.
 Specify all products by their product code.

Pricing Effective: January 2024

MASS STACKING ARM CHAIR
 Design: ITEMdesignworks, licensed by Sellex

MA7



PRICING FOR QUANTITIES 1-99

Mass Stacking Arm Chair	MODEL	FRAME FINISH	LIST PRICE
Polypropylene shell	MASA	Powder Coat	\$520
W 20.5 D 20.5 H 32.25 SH 18		Chrome	\$583

Optional Glides: Add \$8.00 net per chair for a set of four (4).



PRICING FOR QUANTITIES 100-299

Mass Stacking Arm Chair	MODEL	FRAME FINISH	LIST PRICE
Polypropylene shell	MASA	Powder Coat	\$488
W 20.5 D 20.5 H 32.25 SH 18		Chrome	\$554

Optional Glides: Add \$8.00 net per chair for a set of four (4).



PRICING FOR QUANTITIES 300+

Mass Stacking Arm Chair	MODEL	FRAME FINISH	LIST PRICE
Polypropylene shell	MASA	Powder Coat	\$462
W 20.5 D 20.5 H 32.25 SH 18		Chrome	\$519

Optional Glides: Add \$8.00 net per chair for a set of four (4).

To specify:
 Please refer to pages 3-4 for complete specifying information.
 Specify all products by their product code.

Pricing Effective: January 2024

MASS STACKING ARM CHAIR, UPHOLSTERED SEAT
 Design: ITEMdesignworks, licensed by Sellex

MA8



PRICING FOR QUANTITIES 1-99

Mass Stacking Arm Chair

MODEL	LIST PRICE/GRADE	COM/COL	A	B	C	D	E	F	G	H	I	J	K	L
MASAU	Powder Coat	\$606	643	678	714	750	785	821	857	892	929	965	1000	1037
	Chrome	\$673	709	745	781	817	852	888	924	959	995	1032	1067	1103

W 20.5 D 20.5 H 32.25 SH 18

COM Yardage: 1-3 seats: .5 yard
 Contact Leland Customer Experience for yardage requirements on textiles with repeats.
 For COL requirements please contact Leland Customer Experience.
 Optional Glides: Add \$8.00 net per chair for a set of four (4).



PRICING FOR QUANTITIES 100-299

Mass Stacking Arm Chair

MODEL	LIST PRICE/GRADE	COM/COL	A	B	C	D	E	F	G	H	I	J	K	L
MASAU	Powder Coat	\$572	609	645	680	716	752	787	823	860	895	931	967	1003
	Chrome	\$636	672	708	743	780	816	851	887	923	958	994	1030	1066

W 20.5 D 20.5 H 32.25 SH 18

COM Yardage: 1-3 seats: .5 yard
 Contact Leland Customer Experience for yardage requirements on textiles with repeats.
 For COL requirements please contact Leland Customer Experience.
 Optional Glides: Add \$8.00 net per chair for a set of four (4).



PRICING FOR QUANTITIES 300+

Mass Stacking Arm Chair

MODEL	LIST PRICE/GRADE	COM/COL	A	B	C	D	E	F	G	H	I	J	K	L
MASAU	Powder Coat	\$541	577	612	648	684	719	755	792	827	863	900	935	971
	Chrome	\$600	635	671	707	742	778	815	850	886	922	957	993	1029

W 20.5 D 20.5 H 32.25 SH 18

COM Yardage: 1-3 seats: .5 yard
 Contact Leland Customer Experience for yardage requirements on textiles with repeats.
 For COL requirements please contact Leland Customer Experience.
 Optional Glides: Add \$8.00 net per chair for a set of four (4).

To specify:
 Please refer to pages 3-4 for complete specifying information.
 Specify all products by their product code.

Pricing Effective: January 2024

MASS STACKING COUNTER CHAIR
 Design: ITEMdesignworks, licensed by Sellex

MA9



PRICING FOR QUANTITIES 1-99

Mass Stacking Counter Chair	MODEL	FRAME FINISH	LIST PRICE
Polypropylene shell	MASC	Powder Coat	\$671
W 21.75 D 20.5 H 40.75 SH 25		Chrome	\$736

Optional Glides: Add \$8.00 net per chair for a set of four (4).



PRICING FOR QUANTITIES 100-299

Mass Stacking Counter Chair	MODEL	FRAME FINISH	LIST PRICE
Polypropylene shell	MASC	Powder Coat	\$634
W 21.75 D 20.5 H 40.75 SH 25		Chrome	\$696

Optional Glides: Add \$8.00 net per chair for a set of four (4).



PRICING FOR QUANTITIES 300+

Mass Stacking Counter Chair	MODEL	FRAME FINISH	LIST PRICE
Polypropylene shell	MASC	Powder Coat	\$598
W 21.75 D 20.5 H 40.75 SH 25		Chrome	\$635

Optional Glides: Add \$8.00 net per chair for a set of four (4).

To specify:
 Please refer to pages 3-4 for complete specifying information.
 Specify all products by their product code.

Pricing Effective: January 2024

MASS STACKING COUNTER CHAIR, UPHOLSTERED SEAT
 Design: ITEMdesignworks, licensed by Sellex

MA10



PRICING FOR QUANTITIES 1-99

Mass Stacking Counter Chair

Polypropylene shell,
upholstered seat onlay

MODEL	LIST PRICE/GRADE	COM/COL	A	B	C	D	E	F	G	H	I	J	K	L
MASCU	Powder Coat	\$805	841	875	910	945	979	1014	1048	1083	1118	1152	1187	1221
	Chrome	\$871	906	940	975	1010	1044	1079	1113	1148	1183	1217	1252	1288

W 21.75 D 20.5 H 40.75 SH 25

COM Yardage: 1-3 seats: .5 yard
 Contact Leland Customer Experience for yardage requirements on textiles with repeats.
 For COL requirements please contact Leland Customer Experience.
 Optional Glides: Add \$8.00 net per chair for a set of four (4).



PRICING FOR QUANTITIES 100-299

Mass Stacking Counter Chair

Polypropylene shell,
upholstered seat onlay

MODEL	LIST PRICE/GRADE	COM/COL	A	B	C	D	E	F	G	H	I	J	K	L
MASCU	Powder Coat	\$760	795	829	864	900	934	969	1003	1038	1073	1107	1142	1177
	Chrome	\$823	858	892	927	961	997	1032	1066	1102	1137	1171	1206	1240

W 21.75 D 20.5 H 40.75 SH 25

COM Yardage: 1-3 seats: .5 yard
 Contact Leland Customer Experience for yardage requirements on textiles with repeats.
 For COL requirements please contact Leland Customer Experience.
 Optional Glides: Add \$8.00 net per chair for a set of four (4).

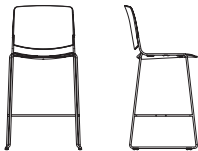

PRICING FOR QUANTITIES 300+

Mass Stacking Counter Chair

Polypropylene shell,
upholstered seat onlay

MODEL	LIST PRICE/GRADE	COM/COL	A	B	C	D	E	F	G	H	I	J	K	L
MASCU	Powder Coat	\$716	751	785	820	855	889	924	958	993	1028	1063	1098	1132
	Chrome	\$774	808	843	878	913	948	982	1017	1052	1087	1122	1156	1191

W 21.75 D 20.5 H 40.75 SH 25

COM Yardage: 1-3 seats: .5 yard
 Contact Leland Customer Experience for yardage requirements on textiles with repeats.
 For COL requirements please contact Leland Customer Experience.
 Optional Glides: Add \$8.00 net per chair for a set of four (4).

To specify:
 Please refer to pages 3-4 for complete specifying information.
 Specify all products by their product code.

Pricing Effective: January 2024

MASS STACKING BAR CHAIR
 Design: ITEMdesignworks, licensed by Sellex

MA11



PRICING FOR QUANTITIES 1-99

Mass Stacking Bar Chair	MODEL	FRAME FINISH	LIST PRICE
Polypropylene shell	MASB	Powder Coat	\$692
W 21.75 D 20.5 H 40.75 SH 29		Chrome	\$759

Optional Glides: Add \$8.00 net per chair for a set of four (4).



PRICING FOR QUANTITIES 100-299

Mass Stacking Bar Chair	MODEL	FRAME FINISH	LIST PRICE
Polypropylene shell	MASB	Powder Coat	\$654
W 21.75 D 20.5 H 40.75 SH 29		Chrome	\$717

Optional Glides: Add \$8.00 net per chair for a set of four (4).



PRICING FOR QUANTITIES 300+

Mass Stacking Bar Chair	MODEL	FRAME FINISH	LIST PRICE
Polypropylene shell	MASB	Powder Coat	\$615
W 21.75 D 20.5 H 40.75 SH 29		Chrome	\$655

Optional Glides: Add \$8.00 net per chair for a set of four (4).

To specify:
 Please refer to pages 3-4 for complete specifying information.
 Specify all products by their product code.

Pricing Effective: January 2024

MASS STACKING BAR CHAIR, UPHOLSTERED SEAT

Design: ITEMdesignworks, licensed by Sellex

MA12



PRICING FOR QUANTITIES 1-99

Mass Stacking Bar Chair

MODEL	LIST PRICE/GRADE	COM/COL	A	B	C	D	E	F	G	H	I	J	K	L
MASBU	Powder Coat	\$831	867	903	938	974	1010	1045	1081	1117	1152	1188	1225	1260
	Chrome	\$897	934	970	1005	1041	1077	1112	1148	1184	1219	1255	1291	1327

W 21.75 D 20.5 H 40.75 SH 29

COM Yardage: 1-3 seats: .5 yard
 Contact Leland Customer Experience for yardage requirements on textiles with repeats.
 For COL requirements please contact Leland Customer Experience.
 Optional Glides: Add \$8.00 net per chair for a set of four (4).

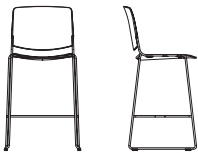

PRICING FOR QUANTITIES 100-299

Mass Stacking Bar Chair

MODEL	LIST PRICE/GRADE	COM/COL	A	B	C	D	E	F	G	H	I	J	K	L
MASBU	Powder Coat	\$783	819	855	890	926	961	998	1034	1070	1106	1142	1177	1213
	Chrome	\$849	885	921	956	992	1028	1063	1100	1135	1171	1208	1243	1279

W 21.75 D 20.5 H 40.75 SH 29

COM Yardage: 1-3 seats: .5 yard
 Contact Leland Customer Experience for yardage requirements on textiles with repeats.
 For COL requirements please contact Leland Customer Experience.
 Optional Glides: Add \$8.00 net per chair for a set of four (4).



PRICING FOR QUANTITIES 300+

Mass Stacking Bar Chair

MODEL	LIST PRICE/GRADE	COM/COL	A	B	C	D	E	F	G	H	I	J	K	L
MASBU	Powder Coat	\$738	774	809	845	882	917	953	989	1024	1060	1096	1131	1167
	Chrome	\$799	835	870	906	942	977	1013	1048	1084	1120	1156	1192	1228

W 21.75 D 20.5 H 40.75 SH 29

COM Yardage: 1-3 seats: .5 yard
 Contact Leland Customer Experience for yardage requirements on textiles with repeats.
 For COL requirements please contact Leland Customer Experience.
 Optional Glides: Add \$8.00 net per chair for a set of four (4).

To specify:

Please refer to pages 3-4 for complete specifying information.
 Specify all products by their product code.

Pricing Effective: January 2024

MASS TRANSPORT/STACKING DOLLY
 Design: ITEMdesignworks, licensed by Sellex

MA13

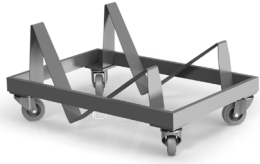

Mass Transport/Stacking Dolly	MODEL	FRAME FINISH	LIST PRICE
Black powder coat finish	MASD		\$1107
W 34.5 D 23 H 17 (Dimensions of dolly when empty)		Mass Transport/Stacking Dolly capacity: 40 high (15 high on floor) Weight with 40 high on dolly: 565 lbs For use with Side and Arm Chair models (including upholstered)	
W 41.25 D 23 H 65.25 (Dimensions with 40 poly chair stack)		**Bar and Counter models do not stack on dolly	

MASS AUXILIARY OPTIONS
 Design: ITEMdesignworks, licensed by Sellex



Ganging Device	MODEL	LIST PRICE
two per set	GD	\$55

Available for all models **Only comes in recycled black

To specify:
 Please refer to pages 3-4 for complete specifying information.
 Specify all products by their product code.

Pricing Effective: January 2024

**5695 Eagle Drive, SE
Grand Rapids,
Michigan 49512
616-975-9260
lelandfurniture.com**

Omena

January 2024 Price List



Omena

Table of Contents	OM2
Specification Information	OM3
Specification Example	OM4
Side Chair	OM5
Counter Stool	OM7
Bar Stool	OM8
Low Stool	OM9

Chair Model

DESCRIPTION	CODE
Omena side chair	OMSW
Omena side chair, upholstered seat	OMSWU
Omena side chair, upholstered seat and back	OMSWUU
Omena counter stool	OMCW
Omena counter stool, upholstered seat	OMCWU
Omena bar stool	OMBW
Omena bar stool, upholstered seat	OMBWU
Omena low stool	OMLW
Omena low stool, upholstered seat	OMLWU

Shell Veneer

DESCRIPTION	CODE
Maple (standard)	M
Oak (premium)	O

Shell Leg/Finish

STANDARD SHELL/LEG (MAPLE):

STANDARD LELAND COLORS

CUSTOM SPECIFY Custom (01)

OAK SHELL/BASE:

DESCRIPTION	CODE
Morel	66M
Weathered	68M
Dune	69M
Trillium	70M

GRADIENT FINISHES

DESCRIPTION	CODE
Blue Sky Gradient BG	90MG
Forest Gradient FG	86MG
Gravel Gradient GG	87MG
Dawn Gradient DG	88MG
Heather Gradient HG	99MG

Gradient Finishes applied on maple shell/leg only and are only offered on Omena side chair and low stool.

Upholstery Selection

Please refer to Leland Textile Program which features textiles and leathers from the following partners:

- Camira
- Green Hides
- Carnegie
- Maharam
- CF Stinson
- Unika Vaev

The complete grade list can be found on our website or you can specify COM/COL. Due to the design of this product, it is recommended that all non pre-approved textile be tested for compatibility.

Glide Type

STANDARD:

DESCRIPTION	CODE
Nylon	S

OPTIONAL:

Please note that optional glides raise the chair height .5 inch.

DESCRIPTION	CODE
Rubber	R
Felt	FC

Stacking note

The Omena chair/stool does not stack.

Specifications required to create the product code

- Model
- Wood Species
- Shell Finish
- Seat Upholstery Selection (when applicable)
- Leg Finish
- Back Upholstery Selection (when applicable)
- Glide Type

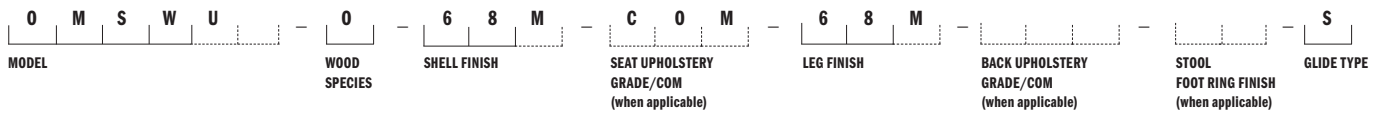

MODEL

Omena Side Chair, Upholstered Seat (OMSWU)

WOOD SPECIES

Oak (O)

SHELL FINISH

Weathered (68M)

SEAT UPHOLSTERY SELECTION

When applicable, enter upholstery grade, COM

LEG FINISH

Weathered (68M)

BACK UPHOLSTERY SELECTION

When applicable, enter upholstery grade, COM



OMENA SIDE CHAIR
 Design: 2B Studio, Will Oltman

OM5



Omema Side Chair	MODEL	LIST PRICE
Maple shell/base	OMSW-M	\$834
W 17.5 D 21 H 31 SH 18		Optional Glides: Add \$8.00 net per chair for a set of four (4). Optional Glides raise chair height .5 inch. Gradient Finishes Upcharge: \$168 List



Omema Side Chair	MODEL	LIST PRICE/GRADE	COM/COL	A	B	C	D	E	F	G	H	I	J	K	L
Maple shell/base, upholstered seat	OMSWU-M		\$978	1021	1043	1064	1087	1109	1130	1152	1175	1196	1218	1240	1262
W 17.5 D 21 H 31 SH 18.5															

Optional Glides: Add \$8.00 net per chair for a set of four (4). Optional Glides raise chair height .5 inch.
 Gradient Finishes Upcharge: \$168 List
 COM Yardage: 0.5 yards, 1-2 seats
 Contact Leland Customer Experience for yardage requirements on textiles with repeats.
 For COL requirements please contact Leland Customer Experience.



Omema Side Chair	MODEL	LIST PRICE/GRADE	COM/COL	A	B	C	D	E	F	G	H	I	J	K	L
Maple shell/base, upholstered seat and back	OMSWUU-M		\$1124	1210	1253	1297	1341	1385	1428	1472	1517	1560	1604	1647	1692
W 17.5 D 21 H 31 SH 18.5															

Optional Glides: Add \$8.00 net per chair for a set of four (4). Optional Glides raise chair height .5 inch.
 Gradient Finishes Upcharge: \$168 List
 1 yard, 1-2 seat and backs
 Contact Leland Customer Experience for yardage requirements on textiles with repeats.
 For COL requirements please contact Leland Customer Experience.

To specify:
 Please refer to pages 3-4 for complete specifying information.
 Specify all products by their product code.

Pricing Effective: January 2024

OMENA SIDE CHAIR
Design: 2B Studio, Will Oltman

OM6



Omena Side Chair	MODEL	LIST PRICE
Oak shell/base	OMSW-0	\$927
W 17.5 D 21 H 31 SH 18	Optional Glides: Add \$8.00 net per chair for a set of four (4). Optional Glides raise chair height .5 inch.	



Omena Side Chair	MODEL	LIST PRICE/GRADE	COM/COL	A	B	C	D	E	F	G	H	I	J	K	L
Oak shell/base, upholstered seat	OMSWU-0		\$1074	1116	1138	1160	1182	1204	1226	1248	1269	1291	1314	1335	1357
W 17.5 D 21 H 31 SH 18.5	Optional Glides: Add \$8.00 net per chair for a set of four (4). Optional Glides raise chair height .5 inch. COM Yardage: 0.5 yards, 1-2 seats Contact Leland Customer Experience for yardage requirements on textiles with repeats. For COL requirements please contact Leland Customer Experience.														



Omena Side Chair	MODEL	LIST PRICE/GRADE	COM/COL	A	B	C	D	E	F	G	H	I	J	K	L
Oak shell/base, upholstered seat and back	OMSWUU-0		\$1218	1303	1348	1391	1435	1479	1523	1567	1610	1656	1699	1743	1787
W 17.5 D 21 H 31 SH 18.5	Optional Glides: Add \$8.00 net per chair for a set of four (4). Optional Glides raise chair height .5 inch. 1 yard, 1-2 seat and backs Contact Leland Customer Experience for yardage requirements on textiles with repeats. For COL requirements please contact Leland Customer Experience.														

To specify:
Please refer to pages 3-4 for complete specifying information.
Specify all products by their product code.

Pricing Effective: January 2024

OMENA COUNTER STOOL
 Design: 2B Studio, Will Oltman

OM7



Omena Counter Stool	MODEL	LIST PRICE
Maple shell	OMCW-M	\$1333
W 17.5 D 21 H 25 SH 24		Optional Glides: Add \$8.00 net per chair for a set of four (4). Optional Glides raise chair height .5 inch.



Omena Counter Stool	MODEL	LIST PRICE/ GRADE	COM/COL	A	B	C	D	E	F	G	H	I	J	K	L
Maple shell, upholstered seat	OMCWU-M		\$1456	1499	1521	1542	1564	1587	1608	1630	1653	1674	1696	1718	1740
W 17.5 D 21 H 25.75 SH 24.75			Optional Glides: Add \$8.00 net per chair for a set of four (4). Optional Glides raise chair height .5 inch. COM yardage: 0.75 yards for 1-2 seats Contact Leland Customer Experience for yardage requirements on textiles with repeats. For COL requirements please contact Leland Customer Experience.												



Omena Counter Stool	MODEL	LIST PRICE
Oak shell	OMCW-O	\$1492
W 17.5 D 21 H 25 SH 24		Optional Glides: Add \$8.00 net per chair for a set of four (4). Optional Glides raise chair height .5 inch.



Omena Counter Stool	MODEL	LIST PRICE/ GRADE	COM/COL	A	B	C	D	E	F	G	H	I	J	K	L
Oak shell, upholstered seat	OMCWU-O		\$1618	1660	1681	1704	1726	1747	1769	1792	1813	1835	1858	1879	1901
W 17.5 D 21 H 25.75 SH 24.75			Optional Glides: Add \$8.00 net per chair for a set of four (4). Optional Glides raise chair height .5 inch. COM yardage: 0.75 yards for 1-2 seats Contact Leland Customer Experience for yardage requirements on textiles with repeats. For COL requirements please contact Leland Customer Experience.												

To specify:
 Please refer to pages 3-4 for
 complete specifying information.
 Specify all products by their
 product code.

Pricing Effective: January 2024

OMENA BAR STOOL
Design: 2B Studio, Will Oltman

OM8



Omena Bar Stool

MODEL

LIST PRICE

Maple shell

OMBW-M

\$1567

W 17.5 D 21 H 31 SH 30

Optional Glides: Add \$8.00 net per chair for a set of four (4). Optional Glides raise chair height .5 inch.



Omena Bar Stool

MODEL

LIST PRICE/
GRADE

COM/COL

A

B

C

D

E

F

G

H

I

J

K

L

Maple shell/base,
upholstered seat

OMBWU-M

\$1712

1756

1777

1799

1821

1843

1865

1886

1909

1931

1952

1974

1997

W 17.5 D 21 H 31.75 SH 30.75

Optional Glides: Add \$8.00 net per chair for a set of four (4). Optional Glides raise chair height .5 inch.
COM yardage: 0.75 yards for 1-2 seats
Contact Leland Customer Experience for yardage requirements on textiles with repeats.
For COL requirements please contact Leland Customer Experience.



Omena Bar Stool

MODEL

LIST PRICE

Oak shell

OMBW-O

\$1756

W 17.5 D 21 H 31 SH 30

Optional Glides: Add \$8.00 net per chair for a set of four (4). Optional Glides raise chair height .5 inch.



Omena Bar Stool

MODEL

LIST PRICE/
GRADE

COM/COL

A

B

C

D

E

F

G

H

I

J

K

L

Oak shell,
upholstered seat

OMBWU-O

\$1901

1944

1966

1987

2009

2032

2053

2075

2098

2119

2141

2162

2185

W 17.5 D 21 H 31.75 SH 30.75

Optional Glides: Add \$8.00 net per chair for a set of four (4). Optional Glides raise chair height .5 inch.
COM yardage: 0.75 yards for 1-2 seats
Contact Leland Customer Experience for yardage requirements on textiles with repeats.
For COL requirements please contact Leland Customer Experience.

To specify:

Please refer to pages 3-4 for complete specifying information. Specify all products by their product code.

Pricing Effective: January 2024

OMENA BAR STOOL
Design: 2B Studio, Will Oltman

OM9



Omena Low Stool

MODEL

LIST PRICE

Maple shell

OMLW-M

\$1276

W 16.5 D 12.09 H 19 SH 18

Optional Glides: Add \$8.00 net per chair for a set of four (4). Optional Glides raise chair height .5 inch.
Gradient Finishes Upcharge: \$168 List



Omena Low Stool

MODEL

LIST PRICE/
GRADE

COM/COL

A

B

C

D

E

F

G

H

I

J

K

L

Maple shell/base,
upholstered seat

OMLWU-M

\$1399

1441

1464

1486

1507

1529

1552

1573

1595

1618

1639

1661

1682

W 17.83 D 13.53 H 19.75
SH 18.75

Optional Glides: Add \$8.00 net per chair for a set of four (4). Optional Glides raise chair height .5 inch.
Gradient Finishes Upcharge: \$168 List
COM yardage: 0.5 yards, 1-2 seats
Contact Leland Customer Experience for yardage requirements on textiles with repeats.
For COL requirements please contact Leland Customer Experience.



Omena Low Stool

MODEL

LIST PRICE

Oak shell

OMLW-O

\$1434

W 16.5 D 12.09 H 19 SH 18

Optional Glides: Add \$8.00 net per chair for a set of four (4). Optional Glides raise chair height .5 inch.



Omena Low Stool

MODEL

LIST PRICE/
GRADE

COM/COL

A

B

C

D

E

F

G

H

I

J

K

L

Oak shell,
upholstered seat

OMLWU-O

\$1559

1602

1624

1645

1667

1690

1711

1733

1756

1777

1799

1821

1843

W 17.83 D 13.53 H 19.75
SH 18.75

Optional Glides: Add \$8.00 net per chair for a set of four (4). Optional Glides raise chair height .5 inch.
COM yardage: 0.5 yards, 1-2 seats
Contact Leland Customer Experience for yardage requirements on textiles with repeats.
For COL requirements please contact Leland Customer Experience.

To specify:

Please refer to pages 3-4 for complete specifying information.
Specify all products by their product code.

Pricing Effective: January 2024

**5695 Eagle Drive, SE
Grand Rapids,
Michigan 49512
616-975-9260
lelandfurniture.com**

Parfait II

January 2024 Price List



Parfait II

Table of Contents	PII2
Specification Information	PII3
Specification Example	PII4
Stacking Side Chair	PII5
Non-Stacking Side Chair	PII6
Mobile Stacking Side Chair	PII7
Mobile Non-Stacking Side Chair	PII9
Arm Chair	PII11
Mobile Arm Chair	PII12
Counter Chair	PII14
Bar Chair	PII15
Transport/Stacking Dolly	PII16

Chair Model

STACKING SIDE CHAIR:

DESCRIPTION	CODE
upholstered seat, wood back	PSSUW
wood seat, wood back	PSSWW
upholstered seat, wood back, upholstered back onlay	PSSUWU

SIDE CHAIR:

DESCRIPTION	CODE
upholstered seat, wood back	PSUW
wood seat, wood back	PSWW
upholstered seat, wood back, upholstered back onlay	PSUWU

ARM CHAIR:

DESCRIPTION	CODE
upholstered seat, wood back, polypropylene arm cap	PAUW
wood seat, wood back, polypropylene arm cap	PAWW
upholstered seat, wood back	
upholstered back onlay, polypropylene arm cap	PAUWU-P
upholstered seat, wood back	
upholstered back onlay, upholstered arm cap	PAUWU-U

COUNTER CHAIR:

DESCRIPTION	CODE
upholstered seat, wood back	PCUW
wood seat, wood back	PCWW
upholstered seat, wood back, upholstered back onlay	PCUWU

BAR CHAIR:

DESCRIPTION	CODE
upholstered seat, wood back	PBUW
wood seat, wood back	PBWW
upholstered seat, wood seat, upholstered back onlay	PBUWU

MOBILE STACKING SIDE CHAIR:

DESCRIPTION	CODE
upholstered seat, wood back	PMSSUW
wood seat, wood back	PMSSWW
upholstered seat, wood back, upholstered back onlay	PMSSUWU

MOBILE SIDE CHAIR (NON-STACKING):

DESCRIPTION	CODE
upholstered seat, wood back	PMSUW
wood seat, wood back	PMSWW
upholstered seat, wood back	PMSUWU

MOBILE ARM CHAIR (NON-STACKING):

DESCRIPTION	CODE
upholstered seat, wood back, polypropylene arm cap	PMAUW
wood seat, wood back, polypropylene arm cap	PMAWW
upholstered seat, wood back,	
upholstered back onlay, polypropylene arm cap	PMAUWU-P
upholstered seat, wood back,	
upholstered back onlay, upholstered arm cap	PMAUWU-U

Upholstery Selection

Please refer to Leland Textile Program which features textiles and leathers from the following partners:

- Camira
- Green Hides
- Carnegie
- Maharam
- CF Stinson
- Unika Vaev

The complete grade list can be found on our website or you can specify COM/COL. Due to the design of this product, it is recommended that all non pre-approved textile be tested for compatibility.

Pricing Effective: January 2024

Seat and Back Wood Finish

STANDARD LELAND COLORS

CUSTOM SPECIFY Custom (01)

*Please note that Parfait II is NOT AVAILABLE in the following finishes:
Natural Walnut Matte (08M), Natural Beech (09), Natural White Oak Matte (12M)

Frame Finish

DESCRIPTION	CODE	DESCRIPTION	CODE
Sterling	ST	Matte Mercury	MMR
Warm Grey	WG	Matte Mineral	MMN
Cool Grey	CG	Matte Burnish	MBN
Black	B	Matte Foundry	MFN
White	W	Matte Forest	MFO
Matte Blue Sky	MBS	Matte Willow	MWL
Matte Sienna	MSN		

TEXTURED	CODE	TEXTURED	CODE
Dolphin Textured	DLT	Oxford Textured	OXT
Black Textured	BT	White Textured	WT

Arm Cap Type

DESCRIPTION	CODE
Polypropylene	P
Upholstered	U

Arm Cap Color (Polypropylene)

DESCRIPTION	CODE
Black	B
Silver	S

Glide Type or Caster Type for Mobile Chairs

STANDARD:

DESCRIPTION	CODE
Nylon	S

OPTIONAL:

DESCRIPTION	CODE
Felt	FC
Floor Saver™ (for VCT type floors)	FS
Metal	M
Rubber	R

Please note that optional glides raise the chair height .5 inch.

CASTER TYPE:

DESCRIPTION	CODE
Hard floor caster	HF
Soft floor caster	SF

Specifications required to create the product code

- Model
- Seat Upholstery or Finish
- Back Finish
- Upholstered Back Onlay (when applicable)
- Frame Finish
- Arm Cap Type (when applicable)
- Arm Cap Color or Upholstery (when applicable)
- Glide or Caster Type

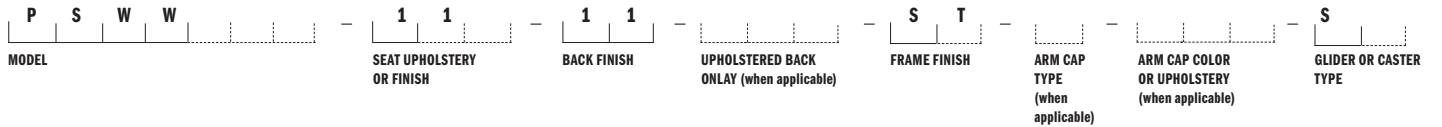

MODEL

Parfait II Side Chair -
wood seat, wood back (PSWW)

SEAT UPHOLSTERY OR FINISH

Natural (11)

BACK FINISH

Natural (11)

UPHOLSTERED BACK ONLAY

When applicable, enter upholstery
grade, COM or COL



FRAME FINISH

Sterling (ST)

ARM CAP TYPE

When applicable, enter
arm cap type code

ARM CAP COLOR OR UPHOLSTERY

When applicable, enter color,
upholstery grade, COM or COL



PARFAIT II STACKING SIDE CHAIR
 Design: Bruce Sienkowski

PII5



Parfait II

Stacking Side Chair

	MODEL	LIST PRICE/GRADE	COM/COL	A	B	C	D	E	F	G	H	I	J	K	L
Upholstered seat, wood back	PSSUW		\$686	717	734	753	770	788	804	822	839	857	875	893	909

W 20.25 D 21.5 H 32.5 SH 19

Optional Glides: Add \$8.00 net per chair for a set of four (4). Optional Glides raise chair height .5 inch.
 COM Yardage: 1 or 2 seats: .75 yard; 3 or 4 seats: 1.5 yards; 5 or 6 seats: 2.25 yards
 Contact Leland Customer Experience for yardage requirements on textiles with repeats.
 For COL requirements please contact Leland Customer Experience.



Parfait II

Stacking Side Chair

	MODEL	LIST PRICE
Wood seat, wood back	PSSWW	\$717

W 20.25 D 21.5 H 32.5 SH 18.5

Optional Glides: Add \$8.00 net per chair for a set of four (4). Optional Glides raise chair height .5 inch.



Parfait II

Stacking Side Chair

	MODEL	LIST PRICE/GRADE	COM/COL	A	B	C	D	E	F	G	H	I	J	K	L
Upholstered seat, wood back upholstered seat and back	PSSUWU	\$773		821	846	870	896	921	946	971	995	1021	1046	1070	1095

W 20.25 D 21.5 H 32.5 SH 19

Optional Glides: Add \$8.00 net per chair for a set of four (4). Optional Glides raise chair height .5 inch.
 COM Yardage: 1 seat and back: .75 yard, 6 seats and backs: 3.5 yards
 Contact Leland Customer Experience for yardage requirements on textiles with repeats.
 For COL requirements please contact Leland Customer Experience.

To specify:
 Please refer to pages 3-5 for complete specifying information.
 Specify all products by their product code.

Pricing Effective: January 2024

PARFAIT II NON-STACKING SIDE CHAIR

Design: Bruce Sienkowski

PII6



Parfait II

Non-Stacking Side Chair

	MODEL	LIST PRICE/GRADE	COM/COL	A	B	C	D	E	F	G	H	I	J	K	L
Upholstered seat, wood back	PSUW		\$618	650	668	685	702	719	738	755	773	790	807	824	842

W 20.25 D 21.5 H 32.5 SH 19

Optional Glides: Add \$8.00 net per chair for a set of four (4). Optional Glides raise chair height .5 inch.
 COM Yardage: 1 or 2 seats: .75 yard; 3 or 4 seats: 1.5 yards; 5 or 6 seats: 2.25 yards
 Contact Leland Customer Experience for yardage requirements on textiles with repeats.
 For COL requirements please contact Leland Customer Experience.



Parfait II

Non-Stacking Side Chair

	MODEL	LIST PRICE
Wood seat, wood back	PSWW	\$653

W 20.5 D 21.5 H 32.5 SH 18.5

Optional Glides: Add \$8.00 net per chair for a set of four (4). Optional Glides raise chair height .5 inch.



Parfait II

Non-Stacking Side Chair

	MODEL	LIST PRICE/ GRADE	COM/COL	A	B	C	D	E	F	G	H	I	J	K	L
Upholstered seat, wood back upholstered seat and back	PSUWU		\$726	774	799	823	848	873	898	924	948	973	999	1023	1048

W 20.5 D 21.5 H 32.5 SH 19

Optional Glides: Add \$8.00 net per chair for a set of four (4). Optional Glides raise chair height .5 inch.
 COM Yardage: 1 seat and back: .75 yard, 6 seats and backs: 3.5 yards
 Contact Leland Customer Experience for yardage requirements on textiles with repeats.
 For COL requirements please contact Leland Customer Experience.

To specify:

Please refer to pages 3-5 for complete specifying information.
 Specify all products by their product code.

Pricing Effective: January 2024

PARFAIT II MOBILE STACKING SIDE CHAIR
 Design: Bruce Sienkowski

PII7

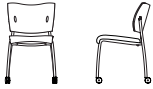

**Parfait II Mobile
 Stacking Side Chair**

	MODEL	LIST PRICE/GRADE	COM/COL	A	B	C	D	E	F	G	H	I	J	K	L
Upholstered seat, wood back hard floor caster	PMSSUW-HF		\$826	858	877	894	911	928	946	963	980	999	1016	1033	1051

COM Yardage: 1 or 2 seats: .75 yard; 3 or 4 seats: 1.5 yards; 5 or 6 seats: 2.25 yards
 Contact Leland Customer Experience for yardage requirements on textiles with repeats.
 For COL requirements please contact Leland Customer Experience.

W 20.25 D 21.5 H 32.5 SH 19

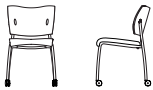

**Parfait II Mobile
 Stacking Side Chair**

	MODEL	LIST PRICE/ GRADE	COM/COL	A	B	C	D	E	F	G	H	I	J	K	L
Upholstered seat, wood back soft floor caster	PMSSUW-SF		\$826	858	877	894	911	928	946	963	980	999	1016	1033	1051

COM Yardage: 1 or 2 seats: .75 yard; 3 or 4 seats: 1.5 yards; 5 or 6 seats: 2.25 yards
 Contact Leland Customer Experience for yardage requirements on textiles with repeats.
 For COL requirements please contact Leland Customer Experience.

W 20.5 D 21.5 H 32.5 SH 19

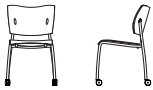

**Parfait II Mobile
 Stacking Side Chair**

	MODEL	LIST PRICE
Wood seat, wood back hard floor caster	PMSSWW-HF	\$867

W 20.5 D 21.5 H 32.5 SH 18.5



**Parfait II Mobile
 Stacking Side Chair**

	MODEL	LIST PRICE
Wood seat, wood back soft floor caster	PMSSWW-SF	\$867

W 20.5 D 21.5 H 32.5 SH 18.5

To specify:
 Please refer to pages 3-5 for
 complete specifying information.
 Specify all products by their
 product code.

PARFAIT II MOBILE STACKING SIDE CHAIR
 Design: Bruce Sienkowski

PII8

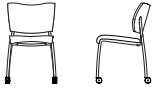

**Parfait II Mobile
 Stacking Side Chair**

	MODEL	LIST PRICE/GRADE	COM/COL	A	B	C	D	E	F	G	H	I	J	K	L
Upholstered seat, wood back upholstered back onlay, hard floor caster	PMSSUWU-HF	\$914		962	987	1012	1036	1063	1087	1112	1137	1161	1187	1213	1237
W 20.25 D 21.5 H 32.5 SH 19															

COM Yardage: 1 seat and back: .75 yard, 6 seats and backs: 3.5 yard
 Contact Leland Customer Experience for yardage requirements on textiles with repeats.
 For COL requirements please contact Leland Customer Experience.

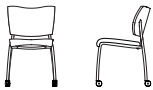

**Parfait II Mobile
 Stacking Side Chair**

	MODEL	LIST PRICE/GRADE	COM/COL	A	B	C	D	E	F	G	H	I	J	K	L
Upholstered seat, wood back upholstered back onlay, soft floor caster	PMSSUWU-SF	\$914		962	987	1012	1036	1063	1087	1112	1137	1161	1187	1213	1237
W 20.25 D 21.5 H 32.5 SH 19															

COM Yardage: 1 seat and back: .75 yard, 6 seats and backs: 3.5 yard
 Contact Leland Customer Experience for yardage requirements on textiles with repeats.
 For COL requirements please contact Leland Customer Experience.

To specify:
 Please refer to pages 3-5 for
 complete specifying information.
 Specify all products by their
 product code.

Pricing Effective: January 2024

PARFAIT II MOBILE NON-STACKING SIDE CHAIR

Design: Bruce Sienkowski

PII9

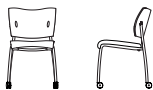

Parfait II Mobile

Non-Stacking Side Chair

	MODEL	LIST PRICE/GRADE	COM/COL	A	B	C	D	E	F	G	H	I	J	K	L
Upholstered seat, wood back, hard floor caster	PMSUW-HF		\$755	786	803	821	838	856	873	891	908	926	943	961	978

W 20.25 D 21.5 H 32.5 SH 19

COM Yardage: 1 or 2 seats: .75 yard; 3 or 4 seats: 1.5 yards; 5 or 6 seats: 2.25 yards
Contact Leland Customer Experience for yardage requirements on textiles with repeats.
For COL requirements please contact Leland Customer Experience.

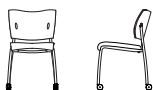

Parfait II Mobile

Non-Stacking Side Chair

	MODEL	LIST PRICE/ GRADE	COM/COL	A	B	C	D	E	F	G	H	I	J	K	L
Upholstered seat, wood back, soft floor caster	PMSUW-SF		\$755	786	803	821	838	856	873	891	908	926	943	961	978

W 20.5 D 21.5 H 32.5 SH 19

COM Yardage: 1 or 2 chair seats and back onlays: .75 yard; 3 or 4 chair seats and back onlays: 1.5 yards;
5 or 6 Chair seats and back onlays: 2.25 yards
Contact Leland Customer Experience for yardage requirements on textiles with repeats.
For COL requirements please contact Leland Customer Experience.



Parfait II Mobile

Non-Stacking Side Chair

	MODEL	LIST PRICE
Wood seat, wood back, hard floor caster	PMSWW-HF	\$796
W 20.5 D 21.5 H 32.5 SH 18.5		



Parfait II Mobile

Non-Stacking Side Chair

	MODEL	LIST PRICE
Wood seat, wood back soft floor caster	PMSWW-SF	\$796
W 20.5 D 21.5 H 32.5 SH 18.5		

To specify:

Please refer to pages 3-5 for complete specifying information.
Specify all products by their product code.

Pricing Effective: January 2024

PARFAIT II MOBILE NON-STACKING SIDE CHAIR

Design: Bruce Sienkowski

PII10

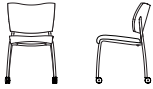

Parfait II Mobile

Non-Stacking Side Chair

	MODEL	LIST PRICE/GRADE	COM/COL	A	B	C	D	E	F	G	H	I	J	K	L
Upholstered seat, wood back upholstered back onlay, hard floor caster	PMSUWU-HF	\$867		916	941	965	990	1016	1041	1066	1091	1115	1140	1167	1191
W 20.25 D 21.5 H 32.5 SH 19															

COM Yardage: 1 seat and back: .75 yard, 6 seats and backs: 3.5 yards
 Contact Leland Customer Experience for yardage requirements on textiles with repeats.
 For COL requirements please contact Leland Customer Experience.

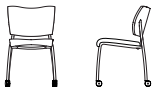

Parfait II Mobile

Non-Stacking Side Chair

	MODEL	LIST PRICE/GRADE	COM/COL	A	B	C	D	E	F	G	H	I	J	K	L
Upholstered seat, wood back upholstered back onlay, soft floor caster	PMSUWU-SF	\$867		916	941	965	990	1016	1041	1066	1091	1115	1140	1167	1191
W 20.25 D 21.5 H 32.5 SH 19															

COM Yardage: 1 seat and back: .75 yard, 6 seats and backs: 3.5 yards
 Contact Leland Customer Experience for yardage requirements on textiles with repeats.
 For COL requirements please contact Leland Customer Experience.

To specify:

Please refer to pages 3-5 for complete specifying information.

Specify all products by their product code.

Pricing Effective: January 2024

PARFAIT II ARM CHAIR
Design: Bruce Sienkowski

PII11



Parfait II Arm Chair	MODEL	LIST PRICE/GRADE	COM/COL	A	B	C	D	E	F	G	H	I	J	K	L
Upholstered seat, wood back	PAUW		\$894	925	944	960	980	999	1016	1034	1052	1069	1087	1107	1124

W 25.5 D 21.5 H 32.5
SH 19 AH 27

Optional Glides: Add \$8.00 net per chair for a set of four (4). Optional Glides raise chair height .5 inch.
COM Yardage: 1 or 2 seats: .75 yard; 3 or 4 seats: 1.5 yards; 5 or 6 seats: 2.25 yards
Contact Leland Customer Experience for yardage requirements on textiles with repeats.
For COL requirements please contact Leland Customer Experience.



Parfait II Arm Chair	MODEL	LIST PRICE
Wood seat, wood back	PAWW	\$925

W 25.5 D 21.5 H 32.5
SH 18.5 AH 18.5

Optional Glides: Add \$8.00 net per chair for a set of four (4). Optional Glides raise chair height .5 inch.



Parfait II Arm Chair	MODEL	LIST PRICE/GRADE	COM/COL	A	B	C	D	E	F	G	H	I	J	K	L
Upholstered seat, wood back Upholstered back onlay, polypropylene arm cap	PAUWU-P		\$960	1013	1038	1063	1088	1115	1141	1166	1192	1218	1243	1269	1294

W 25.5 D 21.5 H 32.5
SH 19 AH 27

Optional Glides: Add \$8.00 net per chair for a set of four (4). Optional Glides raise chair height .5 inch.
COM Yardage: 1 seat and back: .75 yard, 6 seats and backs: 3.5 yards
Contact Leland Customer Experience for yardage requirements on textiles with repeats.
For COL requirements please contact Leland Customer Experience.



Parfait II Arm Chair	MODEL	LIST PRICE/GRADE	COM/COL	A	B	C	D	E	F	G	H	I	J	K	L
Upholstered seat, wood back Upholstered back onlay, upholstered arm cap	PAUWU-U		\$1014	1063	1088	1115	1141	1166	1192	1218	1243	1269	1294	1320	1347

W 25.5 D 21.5 H 32.5
SH 19 AH 27

Optional Glides: Add \$8.00 net per chair for a set of four (4). Optional Glides raise chair height .5 inch.
upholstered arm cap COM Yardage: 1 seat and back: .75 yard, 6 seats and backs: 3.5 yards,
1 or 2 pairs arm caps:.25 yard
Contact Leland Customer Experience for yardage requirements on textiles with repeats.
For COL requirements please contact Leland Customer Experience..

To specify:
Please refer to pages 3-5 for complete specifying information.
Specify all products by their product code.

PARFAIT II MOBILE ARM CHAIR
Design: Bruce Sienkowski

PII12

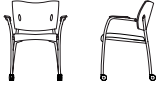

Parfait II Mobile Arm Chair	MODEL	LIST PRICE/GRADE	COM/COL	A	B	C	D	E	F	G	H	I	J	K	L
Upholstered seat, wood back, polypropylene arm cap, hard floor caster	PMAUW-P-HF	\$1053		1085	1103	1121	1140	1158	1175	1193	1211	1229	1247	1266	1283
W 25.5 D 21.5 H 32.5 SH 19 AH 27		COM Yardage: 1 or 2 seats: .75 yard; 3 or 4 seats: 1.5 yards; 5 or 6 seats: 2.25 yards Contact Leland Customer Experience for yardage requirements on textiles with repeats. For COL requirements please contact Leland Customer Experience.													



Parfait II Mobile Arm Chair	MODEL	LIST PRICE/GRADE	COM/COL	A	B	C	D	E	F	G	H	I	J	K	L
Upholstered seat, wood back, polypropylene arm cap, soft floor caster	PMAUW-P-SF	\$1053		1085	1103	1121	1140	1158	1175	1193	1211	1229	1247	1266	1283
W 25.5 D 21.5 H 32.5 SH 19 AH 27		COM Yardage: 1 or 2 chair seats and back onlays: .75 yard; 3 or 4 chair seats and back onlays: 1.5 yards; 5 to 6 Chair seats and back onlays: 2.25 yards Contact Leland Customer Experience for yardage requirements on textiles with repeats. For COL requirements please contact Leland Customer Experience.													



Parfait II Mobile Arm Chair	MODEL	LIST PRICE
Wood seat, wood back, polypropylene arm cap, hard floor caster	PMAWW-P-HF	\$1096
W 25.5 D 21.5 H 32.5 SH 18.5		



Parfait II Mobile Arm Chair	MODEL	LIST PRICE
Wood seat, wood back, polypropylene arm cap, soft floor caster	PMAWW-P-SF	\$1096
W 25.5 D 21.5 H 32.5 SH 18.5		

To specify:
Please refer to pages 3-5 for complete specifying information.
Specify all products by their product code.

Pricing Effective: January 2024

PARFAIT II MOBILE ARM CHAIR

Design: Bruce Sienkowski

PII13



Parfait II Mobile Arm Chair

	MODEL	LIST PRICE/ GRADE	COM/COL	A	B	C	D	E	F	G	H	I	J	K	L
Upholstered seat, Upholstered back onlay, upholstered arm cap, hard floor caster	PMAUWU-U-HF		\$1170	1219	1245	1270	1296	1322	1348	1372	1399	1425	1450	1476	1502
W 25.5 D 21.5 H 32.5 SH 19 AH 27		COM Yardage: 1 seat and back: .75 yard, 6 seats and backs: 3.5 yards 2 pairs armcaps:.25 yard Contact Leland Customer Experience for yardage requirements on textiles with repeats. For COL requirements please contact Leland Customer Experience.													



Parfait II Mobile Arm Chair

	MODEL	LIST PRICE/ GRADE	COM/COL	A	B	C	D	E	F	G	H	I	J	K	L
Upholstered seat, Upholstered back onlay, upholstered arm cap, soft floor caster	PMAUWU-U-SF		\$1170	1219	1245	1270	1296	1322	1348	1372	1399	1425	1450	1476	1502
W 25.5 D 21.5 H 32.5 SH 19 AH 27		COM Yardage: 1 seat and back: .75 yard, 6 seats and backs: 3.5 yards 2 pairs armcaps:.25 yard Contact Leland Customer Experience for yardage requirements on textiles with repeats. For COL requirements please contact Leland Customer Experience.													



Parfait II Mobile Arm Chair

	MODEL	LIST PRICE/ GRADE	COM/COL	A	B	C	D	E	F	G	H	I	J	K	L
Upholstered seat, Upholstered back onlay, polypropylene arm cap, hard floor caster	PMAUWU-P-HF		\$1117	1167	1193	1219	1245	1270	1296	1322	1348	1372	1399	1425	1450
W 25.5 D 21.5 H 32.5 SH 19 AH 27		COM Yardage: 1 seat and back: .75 yard, 6 seats and backs: 3.5 yards Contact Leland Customer Experience for yardage requirements on textiles with repeats. For COL requirements please contact Leland Customer Experience.													



Parfait II Mobile Arm Chair

	MODEL	LIST PRICE/ GRADE	COM/COL	A	B	C	D	E	F	G	H	I	J	K	L
Upholstered seat, Upholstered back onlay, polypropylene arm cap, soft floor caster	PMAUWU-P-SF		\$1117	1167	1193	1219	1245	1270	1296	1322	1348	1372	1399	1425	1450
W 25.5 D 21.5 H 32.5 SH 19 AH 27		COM Yardage: 1 seat and back: .75 yard, 6 seats and backs: 3.5 yards Contact Leland Customer Experience for yardage requirements on textiles with repeats. For COL requirements please contact Leland Customer Experience.													

To specify:

Please refer to pages 3-5 for complete specifying information.
Specify all products by their product code.

Pricing Effective: January 2024

PARFAIT II COUNTER CHAIR
 Design: Bruce Sienkowski

PII14



Parfait II Counter Chair	MODEL	LIST PRICE/GRADE	COM/COL	A	B	C	D	E	F	G	H	I	J	K	L
Upholstered seat, wood back	PCUW	\$886		918	936	954	972	990	1008	1025	1044	1062	1080	1098	1116

W 19.5 D 24 H 39 SH 25.5

Optional Glides: Add \$8.00 net per chair for a set of four (4). Optional Glides raise chair height .5 inch.
 COM Yardage: 1 or 2 seats: .75 yard; 3 or 4 seats: 1.5 yards; 5 or 6 seats: 2.25 yards
 Contact Leland Customer Experience for yardage requirements on textiles with repeats.
 For COL requirements please contact Leland Customer Experience.



Parfait II Counter Chair	MODEL	LIST PRICE
Wood seat, wood back	PCWW	\$925

W 19.5 D 24 H 39 SH 25

Optional Glides: Add \$8.00 net per chair for a set of four (4). Optional Glides raise chair height .5 inch.



Parfait II Counter Chair	MODEL	LIST PRICE/GRADE	COM/COL	A	B	C	D	E	F	G	H	I	J	K	L
Upholstered seat, wood back upholstered back onlay	PCUWU	\$955		1005	1032	1056	1083	1109	1133	1160	1186	1211	1238	1262	1289

W 19.5 D 24 H 39 SH 25.5

Optional Glides: Add \$8.00 net per chair for a set of four (4). Optional Glides raise chair height .5 inch.
 COM Yardage: 1 seat and back: .75 yard, 6 seats and backs: 3.5 yards
 Contact Leland Customer Experience for yardage requirements on textiles with repeats.
 For COL requirements please contact Leland Customer Experience.

To specify:
 Please refer to pages 3-5 for complete specifying information.
 Specify all products by their product code.

Pricing Effective: January 2024

PARFAIT II BAR CHAIR
Design: Bruce Sienkowski

PII15



Parfait II Bar Chair

	MODEL	LIST PRICE/GRADE	COM/COL	A	B	C	D	E	F	G	H	I	J	K	L
Upholstered seat, wood back	PBUW	\$902		934	952	970	988	1005	1023	1041	1060	1078	1096	1113	1131

W 19.5 D 24 H 44 SH 31.5

Optional Glides: Add \$8.00 net per chair for a set of four (4). Optional Glides raise chair height .5 inch.
Yardage: 1 or 2 seats: .75 yard; 3 or 4 seats: 1.5 yards; 5 or 6 seats: 2.25 yards
Contact Leland Customer Experience for yardage requirements on textiles with repeats.
For COL requirements please contact Leland Customer Experience.

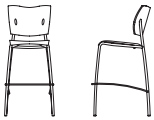

Parfait II Bar Chair

	MODEL	LIST PRICE
Wood seat, wood back	PBWW	\$944

W 19.5 D 24.5 H 44 SH 31

Optional Glides: Add \$8.00 net per chair for a set of four (4). Optional Glides raise chair height .5 inch.

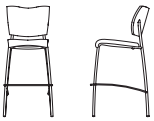

Parfait II Bar Chair

	MODEL	LIST PRICE/GRADE	COM/COL	A	B	C	D	E	F	G	H	I	J	K	L
Upholstered seat, wood back, upholstered back onlay	PBUWU	\$969		1018	1044	1069	1096	1121	1147	1173	1197	1224	1251	1276	1301

W 19.5 D 24 H 44 SH 31.5

Optional Glides: Add \$8.00 net per chair for a set of four (4). Optional Glides raise chair height .5 inch.
COM Yardage: 1 seat and back: .75 yard, 6 seats and backs: 3.5 yards
Contact Leland Customer Experience for yardage requirements on textiles with repeats.
For COL requirements please contact Leland Customer Experience.

To specify:
Please refer to pages 3-5 for complete specifying information.
Specify all products by their product code.

Pricing Effective: January 2024

PARFAIT II TRANSPORT/STACKING DOLLY
Design: Bruce Sienkowski

PII16

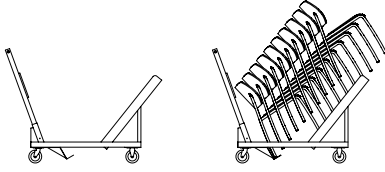

**Parfait II Transport/
Stacking Dolly**

MODEL

LIST PRICE

PSSD

Black Finish

\$1088

W 25 D 57 H 44 (empty)

With 10 stacking chairs:

W 25 D 68 H 63

Parfait II Transport/Stacking Dolly handles up to 10 Parfait II stacking side chairs.

Please note that only the stacking version of the side chair will stack on the floor or Transport/Stacking Dolly.

To specify:

Please refer to pages 3-5 for
complete specifying information.

Specify all products by their
product code.

Pricing Effective: January 2024

5695 Eagle Drive, SE
Grand Rapids,
Michigan 49512
616-975-9260
lelandfurniture.com

Pluto

January 2024 Price List



Pluto

Table of Contents	PB2
Specification Information	PB3
Specification Example	PB4
Bench	PB5
Auxiliary Option	PB6

Bench Model

DESCRIPTION	CODE
Pluto	PT

Upholstery Selection

Please refer to Leland Textile Program which features textiles from the following partners:

- Camira
- Carnegie
- CF Stinson
- Green Hides
- Maharam
- Unika Vaev

The complete grade list can be found on our website or you can specify COM/COL. Due to the design of this product, it is recommended that all non pre-approved textile be tested for compatibility.

Upholstery Requirements

With a choice of textile combinations, Pluto encourages design creativity. Please note that requirements vary by combination. The graded price of the combined yardage will be calculated using the highest grade textile selected.

TEXTILE REQUIREMENTS	YARDAGE
One textile, entire bench:	3.25 yards
Two/Three textile combination	
Seat:	1 yard
Top:	1 yard
Side:	1.25 yards

Plinth Finish: Powdercoat and Chrome

DESCRIPTION	CODE
Sterling	ST
Warm Grey	WG
Cool Grey	CG
Black	B
White	W
Matte Mercury	MMR
Matte Mineral	MMN
Matte Burnish	MBN
Matte Foundry	MFN
Brushed Chrome	BC

Auxiliary Options

Floor mount must be specified at the time of the bench order.

DESCRIPTION	CODE
Floor mount	PTFM

Glides

Pluto glides are poly.

Shipment Detail

200 pounds of weight ballast is shipped separately from the Pluto bench and is required to be installed at the final delivery location.

Specifications required to create the product code

- Model
- Seat Upholstery
- Top Upholstery
- Side Upholstery
- Plinth Finish
- Floor Mount (when applicable)

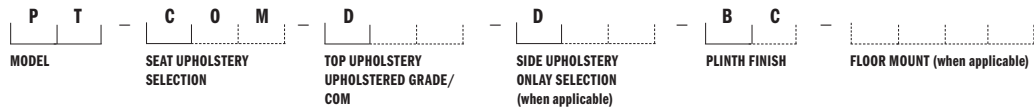

MODEL

Pluto (PT)

SEAT UPHOLSTERY

COM (COM)

TOP UPHOLSTERY

Grade D (D)

SIDE UPHOLSTERY

Grade D (D)

PLINTH FINISH

Brushed Chrome (BC)

FLOOR MOUNT

When applicable, enter Pluto Floor Mount Code



PLUTO BENCH
Design: Simon Pengelly

PB5

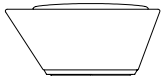

Pluto Bench	MODEL	LIST PRICE/ GRADE	COM/COL	A	B	C	D	E	F	G	H	I	J	K	L	
Powder coat plinth	PT-PC	Powder Coat	\$1751	1985	2103	2220	2338	2455	2573	2691	2808	2926	3044	3161	3279	
W 34 D 37.75 H 16		COM REQUIREMENTS VARY BY COMBINATION SELECTED.														
		TEXTILE REQUIREMENTS:						YARDAGE								
		One textile, entire bench:						3.25 yards								
		Two/Three textile combination														
		Seat:						1 yard								
		Top:						1 yard								
		Side:						1.25 yards								

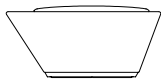

Pluto Bench	MODEL	LIST PRICE/ GRADE	COM/COL	A	B	C	D	E	F	G	H	I	J	K	L	
Brushed chrome plinth	PT-BC	Brushed Chrome	\$1930	2163	2282	2400	2517	2635	2753	2869	2988	3105	3223	3341	3458	
W 34 D 37.75 H 16		COM REQUIREMENTS VARY BY COMBINATION SELECTED.														
		TEXTILE REQUIREMENTS:						YARDAGE								
		One textile, entire bench:						3.25 yards								
		Two/Three textile combination														
		Seat:						1 yard								
		Top:						1 yard								
		Side:						1.25 yards								

To specify:
Please refer to pages 3-4 for
complete specifying information.
Specify all products by their
product code.

Pricing Effective: January 2024

PLUTO BENCH AUXILIARY OPTION

Design: Simon Pengelly

PB6

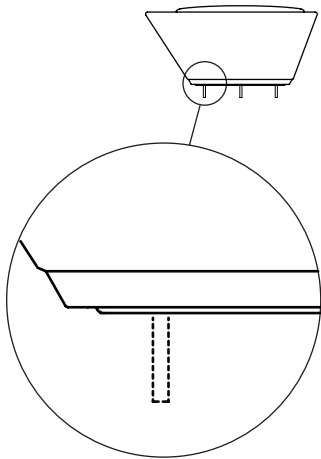

Pluto Floor Mount	MODEL	FRAME FINISH	LIST PRICE
	PTFM	Powder Coat	\$180

Due to the variety of floor surfaces on which the Pluto Bench may be installed, floor mount fasteners are not supplied by Leland International. The Pluto Bench floor mount feature consists of three .5" thru holes designed to use .3125" or .375" threaded studs. Leland International recommends at least 2" of exposed thread length from the floor surface.

Responsibility of fastener choice is the customers.

Floor Mount must be specified at the time of purchasing.

The Floor Mount cannot be added later in the field.

To specify:

Please refer to pages 3-4 for complete specifying information.

Specify all products by their product code.

Pricing Effective: January 2024

**5695 Eagle Drive, SE
Grand Rapids,
Michigan 49512
616-975-9260
lelandfurniture.com**

Quarry

January 2024 Price List



Quarry

Table of Contents	QR2
Bench Specification Information	QR3
Bench Specification Example	QR4
Benches	QR5
Collaborative Work Tools Specification Information	QR6
Collaborative Work Tools Specification Example	QR7
Collaborative Work Tools	QR8
Quarry Groupings	QR9

Bench Model

DESCRIPTION	CODE
Flint	QF
Mica	QM
Shale	QS
Quartz	QQ

Upholstery Selection

Please refer to Leland Textile Program which features textiles and leathers from the following partners:

- Camira
- Carnegie
- CF Stinson
- Green Hides
- Maharam
- Unika Vaev

The complete grade list can be found at www.lelandfurniture.com/ecatalog or you can specify COM/COL. Due to the design of this product, it is recommended that all non pre-approved textile be tested for compatibility.

Stitching Detail

DESCRIPTION	CODE
Basic (Recommended for patterned textiles)	B
Premium (Standard stitch on Quarry Benches)	P

Glide Selection

STANDARD GLIDES:

DESCRIPTION	CODE
Poly	P

OPTIONAL GLIDES:

DESCRIPTION	CODE
Felt	F

Auxiliary Options

DESCRIPTION	CODE
Weight Ballast (50 lbs.)	WB

Plinth Finish

All plinths are stainless steel.

Specifications required to create the product code

- Model
- Upholstery Selection
- Stitching Detail
- Glide Selection
- Auxiliary Option (when applicable)



MODEL

Quarry Flint (QF)

UPHOLSTERY SELECTION

Enter upholstery grade or COM.
Grade D (D)

STITCHING DETAIL

Premium (P)

GLIDE SELECTION

Poly (P)

AUXILIARY OPTION

When applicable



QUARRY BENCHES
Design: Bruce Sienkowski

QR5



Flint	MODEL	LIST PRICE/GRADE	COM/COL	A	B	C	D	E	F	G	H	I	J	K	L
W 19 D 18 H 19	QF	\$1348		1466	1525	1586	1647	1707	1767	1827	1886	1948	2007	2068	2128

Optional Glides: Add \$8.00 net per bench for a set of four (4). Optional Glides raise bench height .5 inch.
 Contrasting Stitch: Add \$25 net per bench - specify black (-CSB) or white thread (-CSW)
 COM Yardage: 1.25 yards
 Contact Leland Customer Experience for yardage requirements on textiles with repeats.



Mica	MODEL	LIST PRICE/GRADE	COM/COL	A	B	C	D	E	F	G	H	I	J	K	L
W 19 D 20 H 19	QM	\$1348		1466	1525	1586	1647	1707	1767	1827	1886	1948	2007	2068	2128

Optional Glides: Add \$8.00 net per bench for a set of four (4). Optional Glides raise bench height .5 inch.
 Contrasting Stitch: Add \$25 net per bench - specify black (-CSB) or white thread (-CSW)
 COM Yardage: 1.25 yards
 Contact Leland Customer Experience for yardage requirements on textiles with repeats.

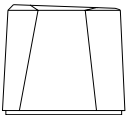

Shale	MODEL	LIST PRICE/GRADE	COM/COL	A	B	C	D	E	F	G	H	I	J	K	L
W 22 D 28.5 H 25.25	QS	\$1481		1645	1726	1809	1889	1971	2053	2134	2216	2297	2379	2461	2541

Optional Glides: Add \$8.00 net per bench for a set of four (4). Optional Glides raise bench height .5 inch.
 Contrasting Stitch: Add \$25 net per bench - specify black (-CSB) or white thread (-CSW)
 COM Yardage: 2.25 yards
 Contact Leland Customer Experience for yardage requirements on textiles with repeats.

Quartz	MODEL	LIST PRICE/GRADE	COM/COL	A	B	C	D	E	F	G	H	I	J	K	L
W 28.5 D 26 H 16.5	QQ	\$1481		1595	1652	1710	1767	1823	1881	1938	1995	2053	2110	2167	2224

Optional Glides: Add \$8.00 net per bench for a set of four (4). Optional Glides raise bench height .5 inch.
 Contrasting Stitch: Add \$25 net per bench - specify black (-CSB) or white thread (-CSW)
 COM Yardage: 1.75 yards
 Contact Leland Customer Experience for yardage requirements on textiles with repeats.

Weight Ballast	MODEL	LIST PRICE
50 lbs.	WB	\$89

To specify:
 Please refer to pages 3-4 for complete specifying information.
 Specify all products by their product code.

Collaborative Work Space Model

DESCRIPTION	CODE
Flint bench with tablet	QFT
Mobile tablet stand	QMT
Power module	QPM

Tablet Support or Mobile Tablet Column Finish

DESCRIPTION	CODE
White	W
Sterling	ST
Black	B

Upholstery Selection

Please refer to Leland Textile Program which features textiles and leathers from the following partners:

- Camira
- Green Hides
- Carnegie
- Maharam
- CF Stinson
- Unika Vaev

The complete grade list can be found on our website or you can specify COM/COL. Due to the design of this product, it is recommended that all non pre-approved textile be tested for compatibility.

Stitching Detail

DESCRIPTION	CODE
Basic (Recommended for patterned textiles)	B
Premium (Standard stitch on Quarry Benches)	P

Top Surface

DESCRIPTION	CODE
Corian®	C
Wood	V
Laminate	L

Top Surface Finish or Color

CORIAN® TOPS:

DESCRIPTION	CODE
Black Corian®	CB
White Corian®	CW
Grey Corian®	CG

WOOD TOPS:

STANDARD LELAND COLORS

*Natural Finish specify Natural 11

**Custom Finish specify Custom 01

LAMINATE TOPS:

DESCRIPTION	CODE
Platinum Wilsonart® (D315-60)	LGP
Black Pionite® (SE101)	LBK
White Wilsonart® (D354-60)	LWH

Note that Collaborative Work Tool edges are finished to match for wood tops and Natural 11 for laminate tops.

Glide Selection

STANDARD:

DESCRIPTION	CODE
Poly	P

OPTIONAL:

DESCRIPTION	CODE
Felt	F

Power Options

DESCRIPTION	CODE
1 Power Unit, three (3) 120v AC receptacles with 7'6" cord	3P
1 Power Unit, four (4) 120v AC receptacles, one (1) USB simplex charger with 7'6" cord	4P

Freight Note

Due to the size and nature of Quarry Collaborative Work Tools, the Freight Program does not apply to this product. Please contact Customer Experience for a quote.

Specifications required to create the product code

- Model
- Tablet Support or Mobile Tablet Stand Column Finish (when applicable)
- Upholstery Selection (when applicable)
- Stitching Detail (when applicable)
- Top Surface
- Top Surface Finish or Color
- Glide Selection
- Power Options (when applicable)



MODEL

Quarry Mobile Tablet Stand (QMT)

TABLET SUPPORT OR MOBILE STAND COLUMN FINISH

White (W)

UPHOLSTERY SELECTION

When applicable, enter upholstery grade or COM

STITCHING DETAIL

When applicable

TOP SURFACE

Corian® (C)

TOP SURFACE FINISH OR COLOR

Grey Corian® (CG)

GLIDE SELECTION

When applicable

POWER OPTIONS

When applicable



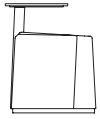

Flint Bench with Tablet				MODEL	LIST PRICE/ GRADE	COM/COL	A	B	C	D	E	F	G	H	I	J	K	L
W 25.6	D 21.5	H 25.5	SH 19	QFT	Corian®	\$2655	2776	2839	2900	2960	3022	3084	3146	3207	3269	3330	3393	3453
					Wood	\$2588	2709	2771	2831	2894	2955	3017	3079	3140	3202	3264	3325	3387
					Laminate	\$2522	2644	2706	2768	2829	2891	2953	3014	3075	3138	3200	3260	3323

Optional Glides: Add \$8.00 net per bench for a set of four (4). Optional Glides raise bench height .5 inch.
COM Yardage: 1.75 yards
Contact Leland Customer Experience for yardage requirements on textiles with repeats.

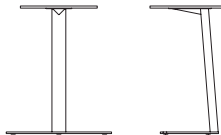

Mobile Tablet Stand			MODEL	FRAME FINISH	LIST PRICE
W 24.7	D 17	H 26	QMT	Corian®	\$1459
				Wood	\$1350
				Laminate	\$1286

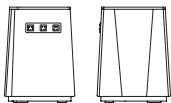

Power Module				MODEL	LIST PRICE/ GRADE	COM/COL	A	B	C	D	E	F	G	H	I	J	K	L
W 16.5	D 17.25	H 22.4		QPM - _ P	Corian®	\$3007	3129	3190	3253	3313	3375	3438	3499	3560	3622	3684	3745	3807
three (3) AC receptacles with 7'6" power cord or four (4) AC receptacles, one (1) USB simplex charger, with 7'6" power cord					Wood	\$2931	3052	3115	3175	3237	3299	3360	3421	3483	3545	3606	3668	3730
					Laminate	\$2868	2991	3052	3115	3175	3237	3299	3360	3421	3483	3545	3606	3668

Optional Glides: Add \$8.00 net per bench for a set of four (4). Optional Glides raise bench height .5 inch.
one (1) USB simplex charger , COM Yardage: 1.5 yards
with 7'6" power cord Contact Leland Customer Experience for yardage requirements on textiles with repeats.

To specify:
Please refer to pages 6-7 for complete specifying information.
Specify all products by their product code.

QUARRY BENCH GROUPINGS

Design: Bruce Sienkowski

QR9

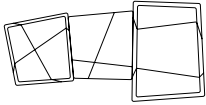

Example A

BENCHES

TOTAL COM LIST PRICE

Flint (QF)

\$4171

Mica (QM)

Shale (QS)

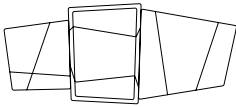

Example B

BENCHES

TOTAL COM LIST PRICE

Mica (QM)

\$4305

Shale (QS)

Quartz (QQ)

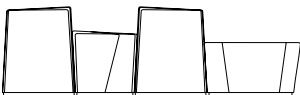
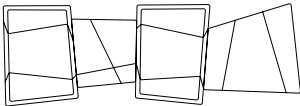

Example C

BENCHES

TOTAL COM LIST PRICE

Shale (QS)

\$5785

Mica (QM)

Shale (QS)

Quartz (QQ)

Please note that example groups are provided as a specification tool. Example groups are shown from top and side profiles. Quarry benches must be ordered as separate line items for each unique model and/or finish specification.

To specify:

Please refer to pages 3-4 for complete specifying information.

Specify all products by their product code.

QUARRY BENCH GROUPINGS

Design: Bruce Sienkowski

QR10

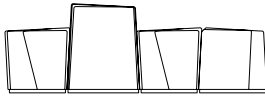
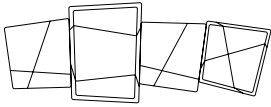

Example D

BENCHES

TOTAL COM LIST PRICE

Mica (QM)

\$5518

Shale (QS)

Mica (QM)

Flint (QF)

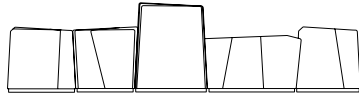
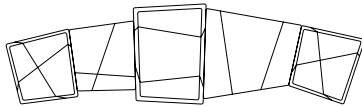

Example E

BENCHES

TOTAL COM LIST PRICE

Flint (QF)

\$6997

Mica (QM)

Shale (QS)

Quartz (QQ)

Flint (QF)

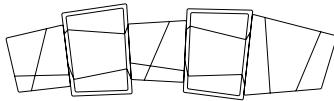

Example F

BENCHES

TOTAL COM LIST PRICE

Mica (QM)

\$7129

Shale (QS)

Mica (QM)

Shale (QS)

Quartz (QQ)

Please note that example groups are provided as a specification tool. Example groups are shown from top and side profiles. Quarry benches must be ordered as separate line items for each unique model and/or finish specification.

To specify:

Please refer to pages 3-4 for complete specifying information.

Specify all products by their product code.

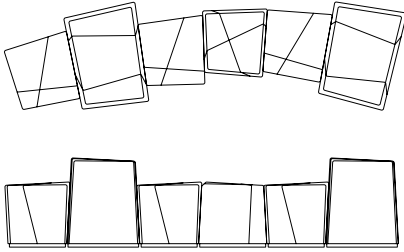

Example G	BENCHES	TOTAL COM LIST PRICE
	Mica (QM)	\$8341
	Shale (QS)	
	Mica (QM)	
	Flint (QF)	
	Mica (QM)	
	Shale (QS)	

Please note that example groups are provided as a specification tool. Example groups are shown from top and side profiles. Quarry benches must be ordered as separate line items for each unique model and/or finish specification.

To specify:
 Please refer to pages 3-4 for complete specifying information.
 Specify all products by their product code.

**5695 Eagle Drive, SE
Grand Rapids,
Michigan 49512
616-975-9260
lelandfurniture.com**

Rapson Forty-Eight

January 2024 Price List



Rapson Forty-Eight Chair

Table of Contents	RP48-C2
Specification Information	RP48-C3
Specification Example	RP48-C4
Four Leg Steel Frame Side Chair	RP48-C5
Four Leg Maple Frame Side Chair	RP48-C7
Four Leg Steel Frame Counter Chair	RP48-C9
Four Leg Maple Frame Counter Chair	RP48-C11
Four Leg Steel Frame Bar Chair	RP48-C13
Four Leg Maple Frame Bar Chair	RP48-C15

RAPSON FORTY-EIGHT CHAIR SPECIFICATION INFORMATION

RP48-C3

Chair Model

DESCRIPTION	CODE
Rapson Forty-Eight Four Leg Steel Frame Side Chair	RP48-SS
Rapson Forty-Eight Four Leg Maple Frame Side Chair	RP48-MS
Rapson Forty-Eight Four Leg Steel Frame Counter Chair	RP48-SC
Rapson Forty-Eight Four Leg Maple Frame Counter Chair	RP48-MC
Rapson Forty-Eight Four Leg Steel Frame Bar Chair	RP48-SB
Rapson Forty-Eight Four Leg Maple Frame Bar Chair	RP48-MB

Shell Options

DESCRIPTION	CODE
Standard Shell	MP
Standard Shell with Upholstered Seat Pad	MPU
Standard HPL Shell	H
Standard HPL Shell with Upholstered Seat Pad	HU
Fully Upholstered	FU
Walnut Shell	W
Walnut Shell with Upholstered Seat Pad	WU
Premium HPL Shell	P
Premium HPL Shell with Upholstered Seat Pad	PU

Shell Finishes

STANDARD HPL

(HIGH PRESSURE LAMINATE)

DESCRIPTION	CODE	DESCRIPTION	CODE
Fiji	FI	Blueberry Tart	BT
Brittany Blue	BB	Oxidized Silver	OS
Moss Grey	MG	Chili Powder	CP
Navaho Red	NR	Marmalade	MM
Fresh Papaya	FP	Copper Alloy	CA
Forsythia	FS		
Kool Kiwi	KK		
Honey Plantain	HP		
Spicy Flavors	SF		
Cafe Sienna	CS		
Designer White	WL		
Platinum	PL		

PREMIUM HPL

(HIGH PRESSURE LAMINATE)

VENEER

STANDARD LELAND COLORS (On maple veneer shell only)

DESCRIPTION	CODE
Walnut	W
Maple	MP

Frame Finish Options

POWDERCOAT

(FOUR LEG STEEL TUBE)

DESCRIPTION	CODE	DESCRIPTION	CODE
Black	B	Cool Grey	CG
Sterling	ST	Matte Burnish	MBN
Warm Grey	WG	Matte Foundry	MFN
White	W	Matte Mineral	MMN
Matte Mercury	MMR	Matte Blue Sky	MBS
Matte Willow	MWL	Matte Forest	MFO
Matte Sienna	MSN	Black Textured	BT
White Textured	WT	Dolphin Textured	DLT

Pricing Effective: January 2024

Frame Finish Options (Cont.)

WOOD

(FOUR LEG WOOD FRAME, ON MAPLE)

DESCRIPTION

LELAND COLORS (Click to view)

Upholstery Option

Please refer to Leland Textile Program which features textiles and leathers from the following partners:

- Camira
- Green Hides
- Carnegie
- Maharam
- CF Stinson
- Unika Vaev

The complete grade list can be found at lelandinternational.com/ecatalog or you can specify COM/COL. Due to the design of this product, it is recommended that all non pre-approved textile be tested for compatibility.

Glide Option

DESCRIPTION	CODE
Nylon (standard)	S
Felt	FC
Floor Saver *only available on metal base	FS
Metal *only available on metal base	M
Rubber *only available on metal base	R

Auxiliary Options

PAINTED GRAPHIC BACK

(VENEER SHELL ONLY)

ART

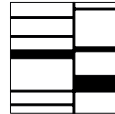

Riff

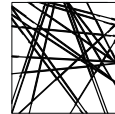

Improv



Bebop

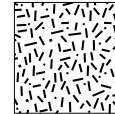

Scat

DESCRIPTION	CODE
Riff	RF
Improv	IM
Bebop	BB
Scat	SC

PAINTED GRAPHIC COLOR OPTIONS

DESCRIPTION	CODE	DESCRIPTION	CODE
Oxford II	49M	Putty	44M
Dolphin II	50M	Oyster	45M

Only available on veneer shells finished in a clear finish (Natural Walnut 08, Natural Walnut 08M, Natural Maple 11, or Natural Maple 11M).

SHELL HANDHOLD

DESCRIPTION	CODE
Handhold	HH

Specifications required to create the product code

- Model
- Shell Selection
- Shell Finish/Color
- Upholstered Onlay Selection (when applicable)
- Frame Finish (or foot ring where applicable)
- Glide Type

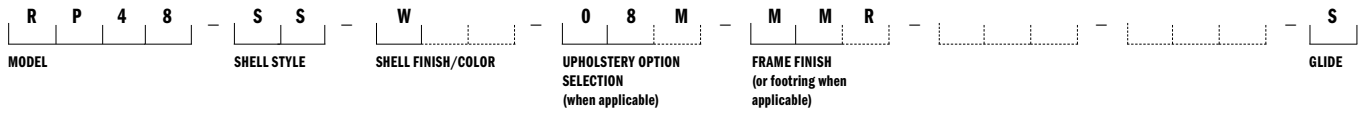

MODEL

Rapson Forty-Eight Side Chair (RP48-SS)

SHELL STYLE

Natural Maple (11)

FRAME FINISH

Sterling (ST)

UPHOLSTERY OPTION

Enter upholstery grade or COM
(when applicable)

GLIDE OPTION

Nylon (S)



RAPSON FORTY-EIGHT FOUR LEG STEEL FRAME
SIDE CHAIR Design: Ralph Rapson

RP48-C5



**Rapson Forty-Eight
Steel Frame Side Chair**

	MODEL	LIST PRICE
Standard HPL Shell	RP48-SS-H	\$644
W 22 D 22.5 H 31.75 SH 18	Optional Glides: Add \$8.00 net per chair for a set of four (4)	



**Rapson Forty-Eight
Steel Frame Side Chair**

	MODEL	COM/COL	A	B	C	D	E	F	G	H	I	J	K	L
Standard HPL Shell, upholstered seat pad	RP48-SS-HU	\$720	767	792	814	837	861	883	907	930	953	976	1000	1021
W 22 D 22.5 H 31.75 SH 18	COM Yardage: 1 or 2 chairs: 1 yard Contact Leland Customer Experience for yardage requirements on textiles with repeats. For COL requirements please contact Leland Customer Experience. Optional Glides: Add \$8.00 net per chair for a set of four (4)													



**Rapson Forty-Eight
Steel Frame Side Chair**

	MODEL	COM/COL	A	B	C	D	E	F	G	H	I	J	K	L
Fully Upholstered	RP48-SS-FU	\$761	851	899	945	991	1038	1084	1130	1176	1223	1269	1316	1362
W 22 D 22.5 H 31.75 SH 18	COM Yardage: 1.5 yards Contact Leland Customer Experience for yardage requirements on textiles with repeats. For COL requirements please contact Leland Customer Experience. Optional Glides: Add \$8.00 net per chair for a set of four (4)													



**Rapson Forty-Eight
Steel Frame Side Chair**

	MODEL	LIST PRICE
Standard Shell	RP48-SS-MP	\$663
W 22 D 22.5 H 31.75 SH 18	Optional Glides: Add \$8.00 net per chair for a set of four (4)	



**Rapson Forty-Eight
Steel Frame Side Chair**

	MODEL	COM/COL	A	B	C	D	E	F	G	H	I	J	K	L
Standard Shell, upholstered seat pad	RP48-SS-MPU	\$740	786	810	834	857	880	904	925	949	972	994	1018	1041
W 22 D 22.5 H 31.75 SH 18	COM Yardage: 1 or 2 chairs: 1 yard Contact Leland Customer Experience for yardage requirements on textiles with repeats. For COL requirements please contact Leland Customer Experience. Optional Glides: Add \$8.00 net per chair for a set of four (4)													

**To specify:
Please refer to pages 3-4 for
complete specifying information.
Specify all products by their
product code.**

RAPSON FORTY-EIGHT FOUR LEG STEEL FRAME
SIDE CHAIR Design: Ralph Rapson

RP48-C6



**Rapson Forty-Eight
Steel Frame Side Chair**

	MODEL	LIST PRICE
Walnut Shell	RP48-SS-W	\$683
W 22 D 22.5 H 31.75 SH 18	Optional Glides: Add \$8.00 net per chair for a set of four (4)	



**Rapson Forty-Eight
Steel Frame Side Chair**

	MODEL	COM/COL	A	B	C	D	E	F	G	H	I	J	K	L
Walnut Shell, upholstered seat pad	RP48-SS-WU	\$761	806	829	851	875	899	922	945	969	991	1015	1038	1061
W 22 D 22.5 H 31.75 SH 18	COM Yardage: 1 or 2 chairs: 1 yard Contact Leland Customer Experience for yardage requirements on textiles with repeats. For COL requirements please contact Leland Customer Experience. Optional Glides: Add \$8.00 net per chair for a set of four (4)													



**Rapson Forty-Eight
Steel Frame Side Chair**

	MODEL	LIST PRICE
Premium HPL Shell	RP48-SS-P	\$842
W 22 D 22.5 H 31.75 SH 18	Optional Glides: Add \$8.00 net per chair for a set of four (4)	



**Rapson Forty-Eight
Steel Frame Side Chair**

	MODEL	COM/COL	A	B	C	D	E	F	G	H	I	J	K	L
Premium HPL Shell, upholstered seat pad	RP48-SS-PU	\$920	967	989	1013	1036	1057	1081	1104	1127	1150	1174	1196	1220
W 22 D 22.5 H 31.75 SH 18	COM Yardage: 1 or 2 chairs: 1 yard Contact Leland Customer Experience for yardage requirements on textiles with repeats. For COL requirements please contact Leland Customer Experience. Optional Glides: Add \$8.00 net per chair for a set of four (4)													

To specify:
 Please refer to pages 3-4 for
 complete specifying information.
 Specify all products by their
 product code.

Pricing Effective: January 2024

RAPSON FORTY-EIGHT MAPLE FRAME
SIDE CHAIR Design: Ralph Rapson

RP48-C7

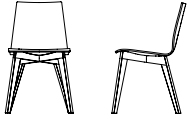

**Rapson Forty-Eight
Maple Frame Side Chair**

	MODEL	LIST PRICE
Standard HPL Shell	RP48-MS-H	\$909
W 19.5 D 21.25 H 32 SH 18.25		Optional Glides: Add \$8.00 net per chair for a set of four (4)

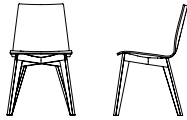

**Rapson Forty-Eight
Maple Frame Side Chair**

	MODEL	COM/COL	A	B	C	D	E	F	G	H	I	J	K	L
Standard HPL Shell, upholstered seat pad	RP48-MS-HU	\$987	1033	1055	1079	1102	1125	1148	1172	1194	1218	1241	1264	1288
W 19.5 D 21.25 H 32 SH 18.25		COM Yardage: 1 or 2 chairs: 1 yard Contact Leland Customer Experience for yardage requirements on textiles with repeats. For COL requirements please contact Leland Customer Experience. Optional Glides: Add \$8.00 net per chair for a set of four (4)												

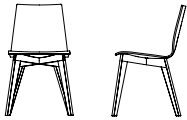

**Rapson Forty-Eight
Maple Frame Side Chair**

	MODEL	COM/COL	A	B	C	D	E	F	G	H	I	J	K	L
Fully Upholstered	RP48-MS-FU	\$1024	1117	1163	1210	1256	1302	1349	1396	1442	1489	1534	1581	1627
W 19.5 D 21.5 H 32 SH 18.25		COM Yardage: 1.5 yards Contact Leland Customer Experience for yardage requirements on textiles with repeats. For COL requirements please contact Leland Customer Experience. Optional Glides: Add \$8.00 net per chair for a set of four (4)												

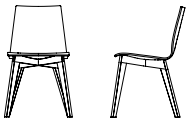

**Rapson Forty-Eight
Maple Frame Side Chair**

	MODEL	LIST PRICE
Standard Shell	RP48-MS-MP	\$929
W 19.5 D 21.25 H 32 SH 18.25		Optional Glides: Add \$8.00 net per chair for a set of four (4)

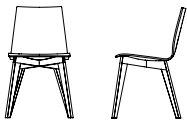

**Rapson Forty-Eight
Maple Frame Side Chair**

	MODEL	COM/COL	A	B	C	D	E	F	G	H	I	J	K	L
Standard Shell, upholstered seat pad	RP48-MS-MPU	\$1005	1052	1076	1098	1121	1145	1167	1191	1214	1238	1259	1283	1306
W 19.5 D 21.5 H 32 SH 18.25		COM Yardage: 1.5 yards Contact Leland Customer Experience for yardage requirements on textiles with repeats. For COL requirements please contact Leland Customer Experience. Optional Glides: Add \$8.00 net per chair for a set of four (4)												

**To specify:
Please refer to pages 3-4 for
complete specifying information.
Specify all products by their
product code.**

RAPSON FORTY-EIGHT MAPLE FRAME
SIDE CHAIR Design: Ralph Rapson

RP48-C8

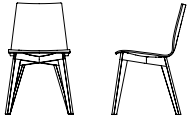

**Rapson Forty-Eight
Maple Frame Side Chair**

	MODEL	LIST PRICE
Walnut Shell	RP48-MS-W	\$947
W 19.5 D 21.5 H 32 SH 18.25	Optional Glides: Add \$8.00 net per chair for a set of four (4)	

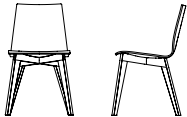

**Rapson Forty-Eight
Maple Frame Side Chair**

	MODEL	COM/COL	A	B	C	D	E	F	G	H	I	J	K	L
Walnut Shell, upholstered seat pad	RP48-MS-WU	\$1024	1072	1095	1117	1141	1163	1187	1210	1233	1256	1280	1302	1325
W 19.5 D 21.5 H 32 SH 18.25	COM Yardage: 1 or 2 chairs: 1 yard Contact Leland Customer Experience for yardage requirements on textiles with repeats. For COL requirements please contact Leland Customer Experience. Optional Glides: Add \$8.00 net per chair for a set of four (4)													

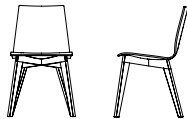

**Rapson Forty-Eight
Maple Frame Side Chair**

	MODEL	LIST PRICE
Premium HPL Shell	RP48-MS-P	\$1108
W 19.5 D 21.5 H 32 SH 18.25	Optional Glides: Add \$8.00 net per chair for a set of four (4)	

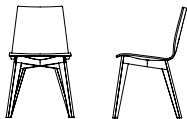

**Rapson Forty-Eight
Maple Frame Side Chair**

	MODEL	COM/COL	A	B	C	D	E	F	G	H	I	J	K	L
Premium HPL Shell, Upholstered seat pad	RP48-MS-PU	\$1184	1230	1254	1277	1300	1323	1347	1369	1393	1415	1439	1462	1486
W 19.5 D 21.5 H 32 SH 18.25	COM Yardage: 1 or 2 chairs: 1 yard Contact Leland Customer Experience for yardage requirements on textiles with repeats. For COL requirements please contact Leland Customer Experience. Optional Glides: Add \$8.00 net per chair for a set of four (4)													

To specify:
 Please refer to pages 3-4 for
 complete specifying information.
 Specify all products by their
 product code.

Pricing Effective: January 2024

RAPSON FORTY-EIGHT FOUR LEG STEEL FRAME
COUNTER CHAIR Design: Ralph Rapson

RP48-C9

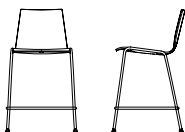

**Rapson Forty-Eight
Steel Frame Counter Chair**

MODEL	LIST PRICE
Standard HPL Shell RP48-SC-H	\$910

W 19.75 D 20.75 H 32 SH 24

Optional Glides: Add \$8.00 net per chair for a set of four (4)

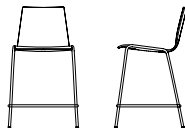

**Rapson Forty-Eight
Steel Frame Counter Chair**

MODEL	COM/COL	A	B	C	D	E	F	G	H	I	J	K	L
Standard HPL Shell, upholstered seat pad RP48-SC-HU	\$988	1034	1056	1080	1103	1126	1149	1173	1195	1219	1242	1266	1289

W 19.75 D 20.75 H 32 SH 24

COM Yardage: 1 or 2 chairs: 1 yard
Contact Leland Customer Experience for yardage requirements on textiles with repeats.
For COL requirements please contact Leland Customer Experience.
Optional Glides: Add \$8.00 net per chair for a set of four (4)

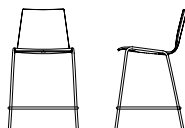

**Rapson Forty-Eight
Steel Frame Counter Chair**

MODEL	COM/COL	A	B	C	D	E	F	G	H	I	J	K	L
Fully Upholstered RP48-SC-FU	\$1025	1119	1164	1211	1257	1303	1350	1397	1444	1490	1535	1582	1628

W 19.75 D 20.75 H 32 SH 24

COM Yardage: 1.5 yards
Contact Leland Customer Experience for yardage requirements on textiles with repeats.
For COL requirements please contact Leland Customer Experience.
Optional Glides: Add \$8.00 net per chair for a set of four (4)

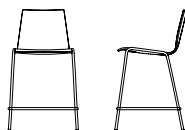

**Rapson Forty-Eight
Steel Frame Counter Chair**

MODEL	LIST PRICE
Standard Shell RP48-SC-MP	\$930

W 19.75 D 20.75 H 32 SH 24

Optional Glides: Add \$8.00 net per chair for a set of four (4)

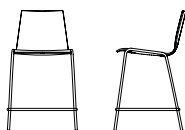

**Rapson Forty-Eight
Steel Frame Counter Chair**

MODEL	COM/COL	A	B	C	D	E	F	G	H	I	J	K	L
Standard Shell, upholstered seat pad RP48-SC-MPU	\$1007	1053	1077	1100	1123	1146	1170	1192	1215	1239	1260	1284	1307

W 19.75 D 20.75 H 32 SH 24

COM Yardage: 1 or 2 chairs: 1 yard
Contact Leland Customer Experience for yardage requirements on textiles with repeats.
For COL requirements please contact Leland Customer Experience.
Optional Glides: Add \$8.00 net per chair for a set of four (4)

**To specify:
Please refer to pages 3-4 for
complete specifying information.
Specify all products by their
product code.**

Pricing Effective: January 2024

RAPSON FORTY-EIGHT FOUR LEG STEEL FRAME
COUNTER CHAIR Design: Ralph Rapson

RP48-C10

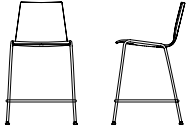

**Rapson Forty-Eight
Steel Frame Counter Chair**

	MODEL	LIST PRICE
Walnut Shell	RP48-SC-W	\$949
W 19.75 D 20.75 H 32 SH 24	Optional Glides: Add \$8.00 net per chair for a set of four (4)	

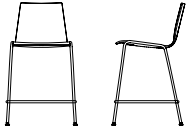

**Rapson Forty-Eight
Steel Frame Counter Chair**

	MODEL	COM/COL	A	B	C	D	E	F	G	H	I	J	K	L
Walnut Shell, upholstered seat pad	RP48-SC-WU	\$1025	1073	1096	1119	1143	1164	1188	1211	1234	1257	1281	1303	1327
W 19.75 D 20.75 H 32 SH 24	COM Yardage: 1 or 2 chairs: 1 yard Contact Leland Customer Experience for yardage requirements on textiles with repeats. For COL requirements please contact Leland Customer Experience. Optional Glides: Add \$8.00 net per chair for a set of four (4)													

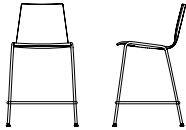

**Rapson Forty-Eight
Steel Frame Counter Chair**

	MODEL	LIST PRICE
Premium HPL Shell	RP48-SC-P	\$1109
W 19.75 D 20.75 H 32 SH 24	Optional Glides: Add \$8.00 net per chair for a set of four (4)	

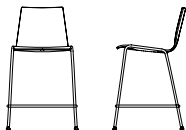

**Rapson Forty-Eight
Steel Frame Counter Chair**

	MODEL	COM/COL	A	B	C	D	E	F	G	H	I	J	K	L
Premium HPL Shell, Upholstered seat pad	RP48-SC-PU	\$1186	1227	1251	1273	1296	1319	1343	1365	1388	1412	1434	1458	1481
W 19.75 D 20.75 H 32 SH 24	COM Yardage: 1 or 2 chairs: 1 yard Contact Leland Customer Experience for yardage requirements on textiles with repeats. For COL requirements please contact Leland Customer Experience. Optional Glides: Add \$8.00 net per chair for a set of four (4)													

To specify:
Please refer to pages 3-4 for complete specifying information.
Specify all products by their product code.

Pricing Effective: January 2024

RAPSON FORTY-EIGHT MAPLE FRAME
COUNTER CHAIR Design: Ralph Rapson

RP48-C11

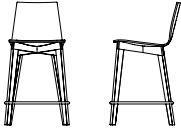

**Rapson Forty-Eight
Maple Frame Counter Chair**

	MODEL	LIST PRICE
Standard HPL Shell	RP48-MC-H	\$1441

W 18.5 D 20 H 35 SH 24

Optional Glides: Add \$8.00 net per chair for a set of four (4)

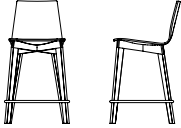

**Rapson Forty-Eight
Maple Frame Counter Chair**

	MODEL	COM/COL	A	B	C	D	E	F	G	H	I	J	K	L
Standard HPL Shell, upholstered seat pad	RP48-MC-HU	\$1518	1564	1587	1609	1634	1657	1680	1702	1726	1748	1772	1795	1818

W 18.5 D 20 H 35 SH 24

COM Yardage: 1 or 2 chairs: 1 yard
Contact Leland Customer Experience for yardage requirements on textiles with repeats.
For COL requirements please contact Leland Customer Experience.
Optional Glides: Add \$8.00 net per chair for a set of four (4)

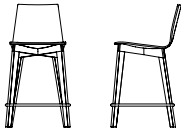

**Rapson Forty-Eight
Maple Frame Counter Chair**

	MODEL	COM/COL	A	B	C	D	E	F	G	H	I	J	K	L
Fully Upholstered	RP48-MC-FU	\$1556	1648	1695	1742	1789	1834	1880	1927	1972	2018	2065	2112	2158

W 18.5 D 20 H 35 SH 24

COM Yardage: 1.5 yards
Contact Leland Customer Experience for yardage requirements on textiles with repeats.
For COL requirements please contact Leland Customer Experience.
Optional Glides: Add \$8.00 net per chair for a set of four (4)

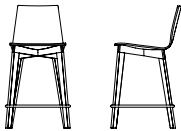

**Rapson Forty-Eight
Maple Frame Counter Chair**

	MODEL	LIST PRICE
Standard Shell	RP48-MC-MP	\$1459

W 18.5 D 20 H 35 SH 24

Optional Glides: Add \$8.00 net per chair for a set of four (4)

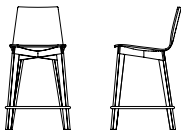

**Rapson Forty-Eight
Maple Frame Counter Chair**

	MODEL	COM/COL	A	B	C	D	E	F	G	H	I	J	K	L
Standard Shell, upholstered seat pad	RP48-MC-MPU	\$1537	1583	1605	1629	1652	1675	1699	1723	1745	1768	1792	1814	1838

W 18.5 D 20 H 35 SH 24

COM Yardage: 1 or 2 chairs: 1 yard
Contact Leland Customer Experience for yardage requirements on textiles with repeats.
For COL requirements please contact Leland Customer Experience.
Optional Glides: Add \$8.00 net per chair for a set of four (4)

**To specify:
Please refer to pages 3-4 for
complete specifying information.
Specify all products by their
product code.**

RAPSON FORTY-EIGHT MAPLE FRAME
COUNTER CHAIR Design: Ralph Rapson

RP48-C12

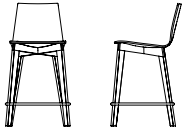

**Rapson Forty-Eight
Maple Frame Counter Chair**

	MODEL	LIST PRICE
Walnut Shell	RP48-MC-W	\$1612
W 18.5 D 20 H 35 SH 24	Optional Glides: Add \$8.00 net per chair for a set of four (4)	

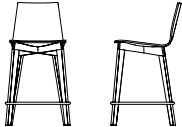

**Rapson Forty-Eight
Maple Frame Counter Chair**

	MODEL	COM/COL	A	B	C	D	E	F	G	H	I	J	K	L
Walnut Shell, upholstered seat pad	RP48-MC-WU	\$1688	1734	1758	1780	1804	1827	1851	1874	1898	1920	1944	1967	1988
W 18.5 D 20 H 35 SH 24	COM Yardage: 1 or 2 chairs: 1 yard Contact Leland Customer Experience for yardage requirements on textiles with repeats. For COL requirements please contact Leland Customer Experience. Optional Glides: Add \$8.00 net per chair for a set of four (4)													

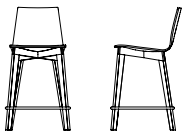

**Rapson Forty-Eight
Maple Frame Counter Chair**

	MODEL	LIST PRICE
Premium HPL Shell	RP48-MC-P	\$1771
W 18.5 D 20 H 35 SH 24	Optional Glides: Add \$8.00 net per chair for a set of four (4)	

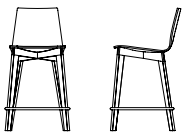

**Rapson Forty-Eight
Maple Frame Counter Chair**

	MODEL	COM/COL	A	B	C	D	E	F	G	H	I	J	K	L
Premium HPL Shell, Upholstered seat pad	RP48-MC-PU	\$1848	1894	1917	1940	1964	1986	2010	2033	2056	2079	2103	2125	2149
W 18.5 D 20 H 35 SH 24	COM Yardage: 1 or 2 chairs: 1 yard Contact Leland Customer Experience for yardage requirements on textiles with repeats. For COL requirements please contact Leland Customer Experience. Optional Glides: Add \$8.00 net per chair for a set of four (4)													

To specify:
 Please refer to pages 3-4 for
 complete specifying information.
 Specify all products by their
 product code.

Pricing Effective: January 2024

RAPSON FORTY-EIGHT FOUR LEG STEEL FRAME
BAR CHAIR Design: Ralph Rapson

RP48-C13



**Rapson Forty-Eight
Steel Frame Bar Chair**

	MODEL	LIST PRICE
Standard HPL Shell	RP48-SB-H	\$925
W 20 D 23 H 41 SH 30		Optional Glides: Add \$8.00 net per chair for a set of four (4)



**Rapson Forty-Eight
Steel Frame Bar Chair**

	MODEL	COM/COL	A	B	C	D	E	F	G	H	I	J	K	L
Standard HPL Shell, upholstered seat pad	RP48-SB-HU	\$1003	1050	1073	1096	1119	1143	1164	1188	1211	1234	1257	1281	1303
W 20 D 23 H 41 SH 30		COM Yardage: 1 or 2 chairs: 1 yard Contact Leland Customer Experience for yardage requirements on textiles with repeats. For COL requirements please contact Leland Customer Experience. Optional Glides: Add \$8.00 net per chair for a set of four (4)												



**Rapson Forty-Eight
Steel Frame Bar Chair**

	MODEL	COM/COL	A	B	C	D	E	F	G	H	I	J	K	L
Fully Upholstered	RP48-SB-FU	\$1041	1133	1181	1227	1273	1319	1365	1412	1458	1505	1552	1598	1644
W 20 D 23 H 41 SH 30		COM Yardage: 1.5 yards Contact Leland Customer Experience for yardage requirements on textiles with repeats. For COL requirements please contact Leland Customer Experience. Optional Glides: Add \$8.00 net per chair for a set of four (4)												



**Rapson Forty-Eight
Steel Frame Bar Chair**

	MODEL	LIST PRICE
Standard Shell	RP48-SB-MP	\$945
W 20 D 23 H 41 SH 30		Optional Glides: Add \$8.00 net per chair for a set of four (4)

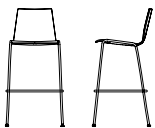

**Rapson Forty-Eight
Steel Frame Bar Chair**

	MODEL	COM/COL	A	B	C	D	E	F	G	H	I	J	K	L
Standard Shell, upholstered seat pad	RP48-SB-MPU	\$1021	1068	1091	1115	1139	1161	1184	1208	1230	1254	1277	1300	1323
W 20 D 23 H 41 SH 30		COM Yardage: 1 or 2 chairs: 1 yard Contact Leland Customer Experience for yardage requirements on textiles with repeats. For COL requirements please contact Leland Customer Experience. Optional Glides: Add \$8.00 net per chair for a set of four (4)												

**To specify:
Please refer to pages 3-4 for
complete specifying information.
Specify all products by their
product code.**

Pricing Effective: January 2024

RAPSON FORTY-EIGHT FOUR LEG STEEL FRAME
BAR CHAIR Design: Ralph Rapson

RP48-C14

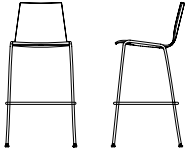

**Rapson Forty-Eight
Steel Frame Bar Chair**

	MODEL	LIST PRICE
Walnut Shell	RP48-SB-W	\$967
W 20 D 23 H 41 SH 30		Optional Glides: Add \$8.00 net per chair for a set of four (4)

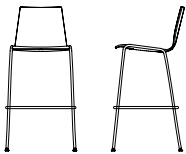

**Rapson Forty-Eight
Steel Frame Bar Chair**

	MODEL	COM/COL	A	B	C	D	E	F	G	H	I	J	K	L
Walnut Shell, upholstered seat pad	RP48-SB-WU	\$1043	1088	1112	1135	1159	1182	1206	1228	1252	1275	1298	1320	1344
W 20 D 23 H 41 SH 30		COM Yardage: 1 or 2 chairs: 1 yard Contact Leland Customer Experience for yardage requirements on textiles with repeats. For COL requirements please contact Leland Customer Experience. Optional Glides: Add \$8.00 net per chair for a set of four (4)												

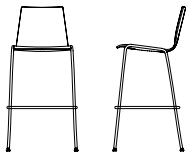

**Rapson Forty-Eight
Steel Frame Bar Chair**

	MODEL	LIST PRICE
Premium HPL Shell	RP48-SB-P	\$1124
W 20 D 23 H 41 SH 30		Optional Glides: Add \$8.00 net per chair for a set of four (4)

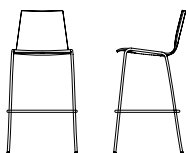

**Rapson Forty-Eight
Steel Frame Bar Chair**

	MODEL	COM/COL	A	B	C	D	E	F	G	H	I	J	K	L
Premium HPL Shell, Upholstered seat pad	RP48-SB-PU	\$1080	1242	1266	1289	1313	1335	1358	1382	1403	1427	1450	1473	1496
W 20 D 23 H 41 SH 30		COM Yardage: 1 or 2 chairs: 1 yard Contact Leland Customer Experience for yardage requirements on textiles with repeats. For COL requirements please contact Leland Customer Experience. Optional Glides: Add \$8.00 net per chair for a set of four (4)												

To specify:
 Please refer to pages 3-4 for
 complete specifying information.
 Specify all products by their
 product code.

Pricing Effective: January 2024

RAPSON FORTY-EIGHT MAPLE FRAME
BAR CHAIR Design: Ralph Rapson

RP48-C15



**Rapson Forty-Eight
Maple Frame Bar Chair**

	MODEL	LIST PRICE
Standard HPL Shell	RP48-MB-H	\$1721
W 19.5 D 20.5 H 41 SH 30		Optional Glides: Add \$8.00 net per chair for a set of four (4)



**Rapson Forty-Eight
Maple Frame Bar Chair**

	MODEL	COM/COL	A	B	C	D	E	F	G	H	I	J	K	L
Standard HPL Shell, upholstered seat pad	RP48-MB-HU	\$1797	1843	1867	1890	1913	1937	1961	1983	2007	2030	2052	2076	2099
W 19.5 D 20.5 H 41 SH 30		COM Yardage: 1 or 2 chairs: 1 yard Contact Leland Customer Experience for yardage requirements on textiles with repeats. For COL requirements please contact Leland Customer Experience. Optional Glides: Add \$8.00 net per chair for a set of four (4)												



**Rapson Forty-Eight
Maple Frame Bar Chair**

	MODEL	COM/COL	A	B	C	D	E	F	G	H	I	J	K	L
Fully Upholstered	RP48-MB-FU	\$1837	1929	1975	2021	2068	2114	2160	2207	2253	2298	2345	2392	2439
W 19.5 D 20.5 H 41 SH 30		COM Yardage: 1.5 yards Contact Leland Customer Experience for yardage requirements on textiles with repeats. For COL requirements please contact Leland Customer Experience. Optional Glides: Add \$8.00 net per chair for a set of four (4)												



**Rapson Forty-Eight
Maple Frame Bar Chair**

	MODEL	LIST PRICE
Standard Shell	RP48-MB-MP	\$1740
W 19.5 D 20.5 H 41 SH 30		Optional Glides: Add \$8.00 net per chair for a set of four (4)



**Rapson Forty-Eight
Maple Frame Bar Chair**

	MODEL	COM/COL	A	B	C	D	E	F	G	H	I	J	K	L
Standard Shell, upholstered seat pad	RP48-SB-MPU	\$1817	1864	1886	1909	1933	1955	1980	2003	2025	2048	2072	2094	2118
W 19.5 D 20.5 H 41 SH 30		COM Yardage: 1 or 2 chairs: 1 yard Contact Leland Customer Experience for yardage requirements on textiles with repeats. For COL requirements please contact Leland Customer Experience. Optional Glides: Add \$8.00 net per chair for a set of four (4)												

To specify:
Please refer to pages 3-4 for complete specifying information.
Specify all products by their product code.

Pricing Effective: January 2024

RAPSON FORTY-EIGHT FOUR MAPLE FRAME
BAR CHAIR Design: Ralph Rapson

RP48-C16



**Rapson Forty-Eight
Maple Frame Bar Chair**

	MODEL	LIST PRICE
Walnut Shell	RP48-MB-W	\$1892
W 19.5 D 20.5 H 41 SH 30	Optional Glides: Add \$8.00 net per chair for a set of four (4)	



**Rapson Forty-Eight
Maple Frame Bar Chair**

	MODEL	COM/COL	A	B	C	D	E	F	G	H	I	J	K	L
Walnut Shell, upholstered seat pad	RP48-MB-WU	\$1970	2016	2040	2063	2086	2108	2133	2155	2178	2202	2224	2248	2271

W 19.5 D 20.5 H 41 SH 30

COM Yardage: 1 or 2 chairs: 1 yard
Contact Leland Customer Experience for yardage requirements on textiles with repeats.
For COL requirements please contact Leland Customer Experience.
Optional Glides: Add \$8.00 net per chair for a set of four (4)

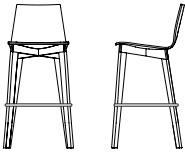

**Rapson Forty-Eight
Maple Frame Bar Chair**

	MODEL	LIST PRICE
Premium HPL Shell	RP48-MB-P	\$2051
W 19.5 D 20.5 H 41 SH 30	Optional Glides: Add \$8.00 net per chair for a set of four (4)	



**Rapson Forty-Eight
Maple Frame Bar Chair**

	MODEL	COM/COL	A	B	C	D	E	F	G	H	I	J	K	L
Premium HPL Shell, Upholstered seat pad	RP48-MB-PU	\$2127	2175	2199	2221	2245	2268	2291	2314	2338	2359	2382	2406	2428

W 19.5 D 20.5 H 41 SH 30

COM Yardage: 1 or 2 chairs: 1 yard
Contact Leland Customer Experience for yardage requirements on textiles with repeats.
For COL requirements please contact Leland Customer Experience.
Optional Glides: Add \$8.00 net per chair for a set of four (4)

To specify:
Please refer to pages 3-4 for complete specifying information.
Specify all products by their product code.

Pricing Effective: January 2024

Painted Back	MODEL	LIST PRICE
	Reference color codes on page RP48-C3	\$200

Handhold	MODEL	LIST PRICE
	HH	\$36

To specify:
Please refer to pages 3-4 for
complete specifying information.
Specify all products by their
product code.

5695 Eagle Drive, SE
Grand Rapids,
Michigan 49512
616-975-9260
lelandfurniture.com

Rapson Thirty-Nine Bench

January 2024 Price List



Rapson Thirty-Nine Bench

Table of Contents	RP39-BN2
Specification Information	RP39-BN3
Specification Example	RP39-BN4
Rapson Thirty-Nine Bench 20"	RP39-BN5
Rapson Thirty-Nine Bench 48"	RP39-BN5

Bench Model

DESCRIPTION	CODE
Rapson Thirty-Nine Bench	RP39-BN

Bench Width

DESCRIPTION	CODE
20"	20
48"	48

Bench Frame and Button Finish Options

DESCRIPTION	CODE
Natural Walnut	08M
Natural Ash	07M

Upholstery Selection

Please refer to Leland Textile Program which features textiles and leathers from the following partners:

- Camira
- Green Hides
- Carnegie
- Maharam
- CF Stinson
- Unika Vaev

The complete grade list can be found at lelandinternational.com/ecatalog or you can specify COM/COL. Due to the design of this product, it is recommended that all non pre-approved textile be tested for compatibility.

Glide Option

DESCRIPTION	CODE
Nylon (standard)	S
Felt	F

RAPSON THIRTY-NINE BENCH SPECIFICATION EXAMPLE

RP39-BN4

Specifications required to create the product code

- Model
- Bench Width
- Bench Frame and Button Finish Selection
- Upholstery Selection
- Glide Option

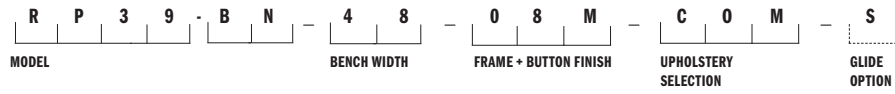

MODEL

Rapson Thirty-Nine Bench (RP39-BN)

BENCH WIDTH

48" (48)

BENCH FRAME + BUTTON FINISH

Natural Walnut (08M)

UPHOLSTERY SELECTION

Enter upholstery grade or COM

GLIDE OPTION

Nylon (S)



RAPSON THIRTY-NINE BENCH
Design: Ralph Rapson

RP39-BN5

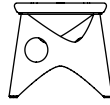
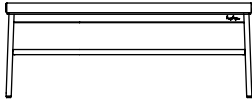

Rapson Thirty-Nine	MODEL	COM/COL	A	B	C	D	E	F	G	H	I	J	K	L
48" Bench	RP39-BN-48	\$2294	2388	2436	2484	2530	2578	2625	2672	2719	2766	2812	2860	2907

W 48.5 D 19.25 H 18.5

COM Yardage: 1.5 yards
Contact Leland Customer Experience for yardage requirements on textiles with repeats.
For COL requirements please contact Leland Customer Experience.

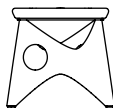

Rapson Thirty-Nine	MODEL	COM/COL	A	B	C	D	E	F	G	H	I	J	K	L
20" Bench	RP39-BN-20	\$1435	1467	1484	1498	1515	1531	1545	1561	1576	1593	1607	1624	1639

W 19.5 D 19.25 H 18.5

COM Yardage: 1.5 yards
Contact Leland Customer Experience for yardage requirements on textiles with repeats.
For COL requirements please contact Leland Customer Experience.

To specify:
Please refer to pages 3-4 for complete specifying information.
Specify all products by their product code.

Pricing Effective: January 2024

5695 Eagle Drive, SE
Grand Rapids,
Michigan 49512
616-975-9260
lelandfurniture.com

Rapson Thirty-Nine Guest

January 2024 Price List



Rapson Thirty-Nine Guest

Table of Contents	RP39-G2
Specification Information	RP39-G3
Specification Example	RP39-G4
Guest Chair	RP39-G5

Chair Model

DESCRIPTION	CODE
Rapson Thirty-Nine Guest Chair	RP39-G

Frame Finish Options

DESCRIPTION	CODE
Natural Walnut	08M
Natural Ash	07M

Fully Upholstered or Onlay Selection

Please refer to Leland Textile Program which features textiles and leathers from the following partners:

- Camira
- Carnegie
- CF Stinson
- Green Hides
- Maharam
- Unika Vaev

The complete grade list can be found at www.lelandfurniture.com/ecatalog or you can specify COM/COL. Due to the design of this product, it is recommended that all non pre-approved textile be tested for compatibility.

Optional Contrasted Upper Back Upholstery

Please refer to Leland Textile Program which features textiles and leathers from the following partners:

- Camira
- Carnegie
- CF Stinson
- Green Hides
- Maharam
- Unika Vaev

The complete grade list can be found at www.lelandfurniture.com/ecatalog or you can specify COM/COL. Due to the design of this product, it is recommended that all non pre-approved textile be tested for compatibility.

Glide Option

DESCRIPTION	CODE
Nylon (standard)	S
Felt	F

Specifications required to create the product code

- Model
- Frame Finish Selection
- Upholstery Selection
- Optional Upper Back Upholstery
- Glide Option

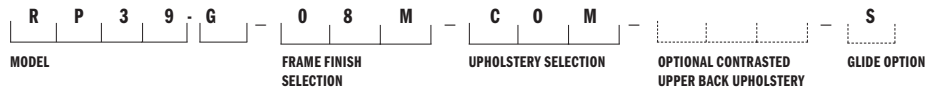

MODEL

Rapson Thirty-Nine Guest (RP39-G)

FRAME FINISH

Natural Walnut (08M)

UPHOLSTERY SELECTION

Enter upholstery grade or COM

GLIDE OPTION

Nylon (S)



RAPSON THIRTY-NINE GUEST
 Design: Ralph Rapson

RP39-G5

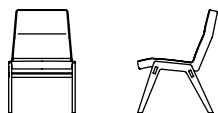

Rapson Thirty-Nine

	MODEL	COM/COL	A	B	C	D	E	F	G	H	I	J	K	L
Guest Chair	RP39-G	\$2728	2822	2870	2917	2965	3011	3059	3106	3152	3200	3247	3293	3341

W 22 D 27 H 35 SH 18.5

COM Yardage: 1 seat: 2.75 yards
 Contact Leland Customer Experience for yardage requirements on textiles with repeats.
 Optional Glides: Add \$8.00 net per chair for a set of four (4).

To specify:
 Please refer to pages 3-4 for complete specifying information.
 Specify all products by their product code.

Pricing Effective: January 2024

**5695 Eagle Drive, SE
Grand Rapids,
Michigan 49512
616-975-9260
lelandfurniture.com**

Rapson Thirty-Nine Lounge

January 2024 Price List



Rapson Thirty-Nine Lounge

Table of Contents	RP39-L2
Specification Information	RP39-L3
Specification Example	RP39-L4
Rapson Thirty-Nine Lounge	RP39-L5

Chair Model

DESCRIPTION	CODE
Rapson Thirty-Nine Lounge Chair	RP39-L

Frame Finish Options

DESCRIPTION	CODE
Natural Walnut	08M
Natural Ash	07M

Fully Upholstered or Onlay Selection

Please refer to Leland Textile Program which features textiles and leathers from the following partners:

- Camira
- Carnegie
- CF Stinson
- Green Hides
- Maharam
- Unika Vaev

The complete grade list can be found at www.lelandfurniture.com/ecatalog or you can specify COM/COL. Due to the design of this product, it is recommended that all non pre-approved textile be tested for compatibility.

Glide Option

DESCRIPTION	CODE
Nylon (standard)	S
Felt	F

Specifications required to create the product code

- Model
- Frame Finish Selection
- Upholstery Selection
- Glide Option

R **P** **3** **9** **-** **L** - **0** **8** **M** - **C** **O** **M** - **S**
MODEL FRAME FINISH UPHOLSTERY SELECTION GLIDE OPTION

MODEL

Rapson Thirty-Nine Lounge (RP39-L)

FRAME FINISH

Natural Walnut (08M)

UPHOLSTERY SELECTION

Enter upholstery grade or COM

GLIDE OPTION

Nylon (S)



RAPSON THIRTY-NINE LOUNGE
 Design: Ralph Rapson

RP39-L5

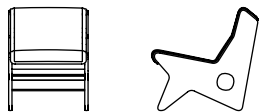

Rapson Thirty-Nine

	MODEL	COM/COL	A	B	C	D	E	F	G	H	I	J	K	L
Lounge Chair	RP39-L	\$3232	3343	3398	3453	3509	3563	3618	3673	3728	3784	3838	3893	3950

W 24 D 32.25 H 31 SH 18.25

COM Yardage: 1 seat: 1.75 yards
 Contact Leland Customer Experience for yardage requirements on textiles with repeats.
 Optional Glides: Add \$8.00 net per chair for a set of four (4).

To specify:
 Please refer to pages 3-4 for complete specifying information.
 Specify all products by their product code.

Pricing Effective: January 2024

**5695 Eagle Drive, SE
Grand Rapids,
Michigan 49512
616-975-9260
lelandfurniture.com**

Slam

January 2024 Price List



Slam

Table of Contents	SL2
Specification Information	SL3
Specification Example	SL4
Sled Base	SL5
Stacking Four-Leg Base	SL7
Stacking Arm Chair, Four-Leg Base	SL9
Wood Leg Chair	SL11
Stacking Four-Leg Mobile Base	SL13
Side Chair, Aluminum Base	SL15
Arm Chair, Aluminum Base	SL17
Task Base	SL19
Sled Counter Chair	SL21
Four-Leg Counter Chair	SL23
Sled Bar Chair	SL25
Four-Leg Bar Chair	SL27
Stacking/Transport Dolly	SL29
Slam Lounge	SL30

Chair Model

DESCRIPTION	CODE
SLAM sled base	SLS
SLAM stacking 4-leg base	SL4
SLAM stacking arm chair, 4-leg base	SL4A
SLAM stacking 4-leg mobile base	SLM
SLAM side chair, 4-leg aluminum base	SLA
SLAM arm chair, 4-leg aluminum base	SLAA
SLAM task base	SLTB
SLAM side chair, beech wood leg	SLW
SLAM side chair, oak wood leg	SLWO
SLAM sled, counter chair	SLCS
SLAM 4-leg, counter chair	SLC4
SLAM sled, bar chair	SLBS
SLAM 4-leg, bar chair	SLB4
SLAM lounge	SLL

Shell Selection

DESCRIPTION	CODE
Polypropylene	PO
Polypropylene with Upholstered Seat Onlay	PU
Fully Upholstered	FU
3D Beech Veneer	3DB
3D Beech Veneer with Upholstered Seat Onlay	3BU
3D Oak Veneer	3DO
3D Oak Veneer with Upholstered Seat Onlay	3OU

Shell Finish/Color

POLYPROPYLENE SHELL:

DESCRIPTION	CODE	DESCRIPTION	CODE
White	WT	Oxford	OX
Black	BK	Forest	FO
Fawn	FW	Pine	PN
Fog	FG	Pistachio	PS
Blue Sky	BS	Dolphin	DL

CUSTOM POLYPROPYLENE COLORS

Custom color match is available upon request. Please contact hello@lelandfurniture.com for further information

BEECH 3D VENEER SHELL AND/OR WOOD LEG:

DESCRIPTION	CODE	DESCRIPTION	CODE
Natural Beech	09	Graphite	25M
Neutral	15	Oxford II	49M
Medium	13	Dolphin II	50M
Classic Mahogany	21M	Blue Sky	100M
White Wash II	30M	Forest	101M
Espresso	23M	Pistachio	110M
Transparent Black	29M		

OAK 3D VENEER SHELL AND/OR WOOD LEG:

DESCRIPTION	CODE
Natural White Oak	12
Pine	109M
Fog	111M

Frame Finish

DESCRIPTION	CODE	DESCRIPTION	CODE
Black	B	White	W
Warm Grey	WG	Cool Grey	CG
Matte Mercury	MMR	Matte Burnish	MBN
Matte Mineral	MMN	Matte Foundry	MFN
Matte Fawn	MFW	Matte Blue Sky	MBS
Matte Fog	MFG	Matte Pine	MPN
Matte Forest	MFO	Sterling	ST
Matte Pistachio	MPS	Polished Aluminum	P
Chrome	C	*Aluminum models only	

Textured Frame Finishes

DESCRIPTION	CODE	DESCRIPTION	CODE
White Textured	WT	Black Textured	BT
Dolphin Textured	DLT	Oxford Textured	OXT

Glide or Caster Type

STANDARD GLIDES:

DESCRIPTION	CODE
Poly (Sled base)	S
Nylon (4-Leg, Aluminum base)	S
Rubber (Slam Wood Leg)	S

OPTIONAL GLIDES:

DESCRIPTION	CODE
Felt	FC
Floor Saver™ (for VCT type floors) (4-Leg base only)	FS
Metal (4-Leg base only)	M
Rubber (4-Leg base or Aluminum Base only)	R

*Please note that optional glides for four leg models raise the chair height .5 inch.

CASTER TYPE:

(for 4-leg mobile and task base)

DESCRIPTION	CODE
Hard Floor Caster	HF
Soft Floor Caster	SF

Fully Upholstered or Onlay Selection

Please refer to Leland Textile Program which features textiles and leathers from the following partners:

- Camira
- Green Hides
- Carnegie
- Maharam
- CF Stinson
- Unika Vaev

The complete grade list can be found at www.lelandfurniture.com/ecatalog or you can specify COM/COL. Due to the design of this product, it is recommended that all non pre-approved textile be tested for compatibility.

Stacking note

SLAM side chair 4 leg base, stacking arm chair, and 4 leg mobile base are the only models available for stacking.

Specifications required to create the product code

- Model
- Shell Selection
- Shell Finish
- Upholstered Onlay Selection (when applicable)
- Frame Finish
- Glide or Caster Type

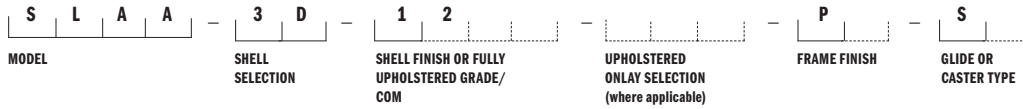

MODEL

Slam arm chair, aluminum base (SLAA)

SHELL SELECTION

3D Veneer (3D)

SHELL FINISH

Natural White Oak (12)

UPHOLSTERED ONLAY SELECTION

When applicable, enter upholstery grade, COM



FRAME FINISH

Polished Aluminum (P)

GLIDE OR CASTER TYPE

Standard Nylon (S)



SLAM SLED BASE CHAIR
 Design: Lievore Altherr Molina, licensed by Sellex

SL5



Slam Sled Base Chair	MODEL	FRAME FINISH	LIST PRICE
Polypropylene shell	SLS-PO	Powder Coat	\$480
W 22.5 D 20.75 H 31.75 SH 18		Chrome	\$548



Slam Sled Base Chair	MODEL	LIST PRICE/GRADE	COM/COL	A	B	C	D	E	F	G	H	I	J	K	L
Polypropylene shell, upholstered seat onlay	SLS-PU	Powder Coat	\$631	701	738	774	809	846	883	918	955	991	1026	1063	1100
		Chrome	\$699	771	806	842	879	914	952	988	1023	1060	1096	1131	1169
W 22.5 D 20.75 H 31.75 SH 18.25		COM Yardage: 1 or 2 seats: .75 yard Contact Leland Customer Experience for yardage requirements on textiles with repeats. For COL requirements please contact Leland Customer Experience.													



Slam Sled Base Chair	MODEL	LIST PRICE/GRADE	COM/COL	A	B	C	D	E	F	G	H	I	J	K	L
Fully upholstered	SLS-FU	Powder Coat	\$709	835	898	960	1023	1086	1149	1212	1275	1337	1400	1463	1526
		Chrome	\$777	903	966	1028	1091	1154	1217	1280	1343	1405	1468	1531	1594
W 22.5 D 20.75 H 31.75 SH 18.25		COM Yardage: 1 seat: 1.5 yards Contact Leland Customer Experience for yardage requirements on textiles with repeats. For COL requirements please contact Leland Customer Experience.													

To specify:
 Please refer to pages 3-4 for complete specifying information.
 Specify all products by their product code.

Pricing Effective: January 2024

SLAM SLED BASE CHAIR

Design: Lievore Altherr Molina, licensed by Sellex

SL6



Slam Sled Base Chair	MODEL	FRAME FINISH	LIST PRICE
3D Beech veneer shell	SLS-3DB	Powder Coat	\$1117
W 22.5 D 20.75 H 31.75 SH 18		Chrome	\$1269



Slam Sled Base Chair	MODEL	LIST PRICE/ GRADE	COM/COL	A	B	C	D	E	F	G	H	I	J	K	L
3D Beech veneer shell, upholstered seat onlay	SLS-3BU	Powder Coat	\$1269	1341	1377	1414	1450	1486	1522	1558	1594	1630	1666	1704	1739
		Chrome	\$1338	1409	1447	1483	1519	1555	1591	1627	1663	1699	1735	1772	1808
W 22.5 D 20.75 H 31.75 SH 18.25		COM Yardage: 1 or 2 seats: .75 yard Contact Leland Customer Experience for yardage requirements on textiles with repeats. Optional Glides: Add \$8.00 net per chair for a set of four (4).													



Slam Sled Base Chair	MODEL	FRAME FINISH	LIST PRICE
3D Oak veneer shell	SLS-3D0	Powder Coat	\$1293
W 22.5 D 20.75 H 31.75 SH 18		Chrome	\$1364



Slam Sled Base Chair	MODEL	LIST PRICE/ GRADE	COM/COL	A	B	C	D	E	F	G	H	I	J	K	L
3D Oak veneer shell, upholstered seat onlay	SLS-30U	Powder Coat	\$1447	1517	1554	1589	1626	1662	1697	1734	1770	1807	1843	1879	1915
		Chrome	\$1514	1586	1622	1659	1694	1730	1767	1802	1838	1876	1911	1948	1984
W 22.5 D 20.75 H 31.75 SH 18.25		COM Yardage: 1 or 2 seats: .75 yard Contact Leland Customer Experience for yardage requirements on textiles with repeats. Optional Glides: Add \$8.00 net per chair for a set of four (4).													

To specify:
 Please refer to pages 3-4 for complete specifying information.
 Specify all products by their product code.

Pricing Effective: January 2024

SLAM 4-LEG BASE CHAIR
 Design: Lievore Altherr Molina, licensed by Sellex

SL7



Slam Stacking

4-Leg Base Chair

	MODEL	FRAME FINISH	LIST PRICE
Polypropylene shell	SL4-PO	Powder Coat	\$483
W 20.75 D 19.75 H 31 SH 18		Chrome	\$551

Optional Glides: Add \$8.00 net per chair for a set of four (4). Optional Glides raise chair height .5 inch.



Slam Stacking

4-Leg Base Chair

	MODEL	LIST PRICE/GRADE	COM/COL	A	B	C	D	E	F	G	H	I	J	K	L
Polypropylene shell, upholstered seat onlay	SL4-PU	Powder Coat	\$657	726	761	796	832	867	902	938	972	1007	1043	1077	1112
		Chrome	\$726	795	830	865	901	937	971	1006	1042	1076	1111	1147	1182

W 20.75 D 19.75 H 31 SH 18.25

Optional Glides: Add \$8.00 net per chair for a set of four (4). Optional Glides raise chair height .5 inch.

COM Yardage: 1 or 2 seats: .75 yard

Contact Leland Customer Experience for yardage requirements on textiles with repeats.

For COL requirements please contact Leland Customer Experience.



Slam Stacking

4-Leg Base Chair

	MODEL	LIST PRICE/GRADE	COM/COL	A	B	C	D	E	F	G	H	I	J	K	L
Fully upholstered	SL4-FU	Powder Coat	\$732	854	915	976	1037	1098	1159	1220	1281	1342	1403	1464	1525
		Chrome	\$800	922	983	1044	1105	1166	1227	1288	1349	1410	1471	1532	1593

W 20.75 D 19.75 H 31 SH 18.25

Optional Glides: Add \$8.00 net per chair for a set of four (4). Optional Glides raise chair height .5 inch.

COM Yardage: 1 seat: 1.5 yards

Contact Leland Customer Experience for yardage requirements on textiles with repeats.

For COL requirements please contact Leland Customer Experience.

To specify:

Please refer to pages 3-4 for complete specifying information.

Specify all products by their product code.

Pricing Effective: January 2024

SLAM 4-LEG BASE CHAIR
 Design: Lievore Altherr Molina, licensed by Sellex

SL8



**Slam Stacking
 4-Leg Base Chair**

	MODEL	FRAME FINISH	LIST PRICE
3D Beech veneer shell W 20.75 D 19.75 H 31 SH 18	SL4-3DB	Powder Coat	\$1103
		Chrome	\$1172

Optional Glides: Add \$8.00 net per chair for a set of four (4). Optional Glides raise chair height .5 inch.



**Slam Stacking
 4-Leg Base Chair**

	MODEL	LIST PRICE/ GRADE	COM/COL												
			A	B	C	D	E	F	G	H	I	J	K	L	
3D Beech veneer shell, upholstered seat onlay W 20.75 D 19.75 H 31 SH 18.25	SL4-3BU	Powder Coat	\$1275	1345	1379	1416	1451	1487	1521	1556	1592	1626	1661	1698	1732
		Chrome	\$1346	1416	1451	1487	1521	1556	1592	1626	1661	1698	1732	1767	1803

Optional Glides: Add \$8.00 net per chair for a set of four (4). Optional Glides raise chair height .5 inch.

COM Yardage: 1 or 2 seats: .75 yard

Contact Leland Customer Experience for yardage requirements on textiles with repeats.

For COL requirements please contact Leland Customer Experience.



**Slam Stacking
 4-Leg Base Chair**

	MODEL	FRAME FINISH	LIST PRICE
3D Oak veneer shell W 20.75 D 19.75 H 31 SH 18	SL4-3D0	Powder Coat	\$1275
		Chrome	\$1342

Optional Glides: Add \$8.00 net per chair for a set of four (4). Optional Glides raise chair height .5 inch.



**Slam Stacking
 4-Leg Base Chair**

	MODEL	LIST PRICE/ GRADE	COM/COL												
			A	B	C	D	E	F	G	H	I	J	K	L	
3D Oak veneer shell, upholstered seat onlay W 20.75 D 19.75 H 31 SH 18.25	SL4-30U	Powder Coat	\$1448	1517	1552	1586	1622	1657	1691	1727	1762	1797	1833	1868	1903
		Chrome	\$1518	1586	1622	1657	1691	1727	1762	1797	1833	1868	1903	1938	1973

Optional Glides: Add \$8.00 net per chair for a set of four (4). Optional Glides raise chair height .5 inch.

COM Yardage: 1 or 2 seats: .75 yard

Contact Leland Customer Experience for yardage requirements on textiles with repeats.

For COL requirements please contact Leland Customer Experience.

To specify:

Please refer to pages 3-4 for complete specifying information. Specify all products by their product code.

Pricing Effective: January 2024

SLAM STACKING ARM CHAIR, 4-LEG BASE
 Design: Lievore Altherr Molina, licensed by Sellex

SL9



Slam Stacking Arm Chair

4-Leg Base

	MODEL	FRAME FINISH	LIST PRICE
Polypropylene shell	SL4A-PO	Powder Coat	\$652
W 25 D 20.75 H 31.75 SH 18 AH 25.5		Chrome with powder coat arm cap	\$723



Slam Stacking Arm Chair

4-Leg Base

	MODEL	LIST PRICE/GRADE	COM/COL	A	B	C	D	E	F	G	H	I	J	K	L
Polypropylene shell upholstered seat onlay	SL4A-PU	Powder Coat	\$804	874	911	947	983	1020	1056	1092	1128	1164	1200	1236	1273
		Chrome with powder coat arm cap	\$874	946	981	1018	1055	1091	1127	1163	1199	1235	1272	1308	1345
W 25 D 20.75 H 31.75 SH 18.25 AH 25.5		COM Yardage: 1 or 2 seats: .75 yard Contact Leland Customer Experience for yardage requirements on textiles with repeats.													



Slam Stacking Arm Chair

4-Leg Base

	MODEL	LIST PRICE/GRADE	COM/COL	A	B	C	D	E	F	G	H	I	J	K	L
Fully upholstered	SL4A-FU	Powder Coat	\$881	1007	1070	1132	1195	1258	1321	1384	1447	1509	1572	1635	1698
W 25 D 20.75 H 31.75 SH 18.25 AH 25.5		Chrome with powder coat arm cap	\$951	1077	1140	1203	1265	1328	1391	1454	1517	1579	1642	1705	1768
		COM Yardage: 1 Seat: 1.5 yards Contact Leland Customer Experience for yardage requirements on textiles with repeats.													

To specify:

Please refer to pages 3-4 for complete specifying information.
 Specify all products by their product code.

Pricing Effective: January 2024

SLAM STACKING ARM CHAIR, 4-LEG BASE
 Design: Lievore Altherr Molina, licensed by Sellex

SL10



Slam Stacking Arm Chair

4-Leg Base

	MODEL	FRAME FINISH	LIST PRICE
3D Beech veneer shell	SL4A-3DB	Powder Coat	\$1291
W 25 D 20.75 H 31.75 SH 18 AH 25.5		Chrome with powder coat arm cap	\$1362



Slam Stacking Arm Chair

4-Leg Base

	MODEL	LIST PRICE/GRADE	COM/COL	A	B	C	D	E	F	G	H	I	J	K	L
3D Beech veneer shell, upholstered seat onlay	SL4A-3BU	Powder Coat	\$1440	1513	1548	1586	1622	1659	1694	1730	1767	1802	1838	1876	1911
W 25 D 20.75 H 31.75 SH 18.25 AH 25.5		Chrome with powder coat arm cap	\$1514	1586	1622	1659	1694	1730	1767	1802	1838	1876	1911	1947	1984

Optional Glides: Add \$8.00 net per chair for a set of four (4). Optional Glides raise chair height .5 inch.
 COM Yardage: 1 or 2 seats: .75 yard
 Contact Leland Customer Experience for yardage requirements on textiles with repeats.



Slam Stacking Arm Chair

4-Leg Base

	MODEL	FRAME FINISH	LIST PRICE
3D Oak veneer shell	SL4A-3DO	Powder Coat	\$1468
W 25 D 20.75 H 31.75 SH 18 AH 25.5		Chrome with powder coat arm cap	\$1537



Slam Stacking Arm Chair

4-Leg Base

	MODEL	LIST PRICE/GRADE	COM/COL	A	B	C	D	E	F	G	H	I	J	K	L
3D Oak veneer shell, upholstered seat onlay	SL4A-3OU	Powder Coat	\$1619	1690	1726	1761	1798	1834	1869	1906	1942	1978	2015	2051	2087
W 25 D 20.75 H 31.75 SH 18.25 AH 25.5		Chrome with powder coat arm cap	\$1691	1761	1798	1834	1869	1906	1942	1978	2015	2051	2087	2123	2159

Optional Glides: Add \$8.00 net per chair for a set of four (4). Optional Glides raise chair height .5 inch.
 COM Yardage: 1 or 2 seats: .75 yard
 Contact Leland Customer Experience for yardage requirements on textiles with repeats.

To specify:

Please refer to pages 3-4 for complete specifying information. Specify all products by their product code.

Pricing Effective: January 2024

SLAM SIDE CHAIR, BEECH WOOD LEG
 Design: Lievore Altherr Molina, licensed by Sellex

SL11



Slam Side Chair, Beech Wood Leg	MODEL	LIST PRICE
Polypropylene shell, Beech Leg	SLW-PO	\$787
W 22.5 D 21.5 H 31 SH 18		

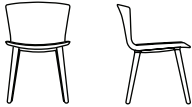

Slam Side Chair, Beech Wood Leg	MODEL	COM/COL	A	B	C	D	E	F	G	H	I	J	K	L
Polypropylene shell, Beech Leg upholstered seat onlay	SLW-PU	\$911	980	1015	1050	1085	1121	1156	1192	1226	1261	1297	1331	1366
W 22.5 D 21.5 H 31 SH 18.25														
COM Yardage: 1 or 2 seats: .75 yard Contact Leland Customer Experience for yardage requirements on textiles with repeats. For COL requirements please contact Leland Customer Experience.														



Slam Side Chair, Beech Wood Leg	MODEL	COM/COL	A	B	C	D	E	F	G	H	I	J	K	L
Fully upholstered, Beech Leg	SLW-FU	\$1016	1142	1205	1267	1330	1393	1456	1519	1582	1644	1707	1770	1833
W 22.5 D 21.5 H 31 SH 18.25														
COM Yardage: 1 seat: 1.5 yards Contact Leland Customer Experience for yardage requirements on textiles with repeats. For COL requirements please contact Leland Customer Experience.														

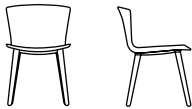

Slam Side Chair, Beech Wood Leg	MODEL	LIST PRICE
3D Beech veneer shell, Beech Leg	SLW-3DB	\$1466
W 22.5 D 21.5 H 31 SH 18		



Slam Side Chair, Beech Wood Leg	MODEL	COM/COL	A	B	C	D	E	F	G	H	I	J	K	L
3D Beech veneer shell, Beech Leg upholstered seat onlay	SLW-3BU	\$1659	1729	1766	1801	1837	1875	1910	1946	1983	2018	2055	2091	2126
W 22.5 D 21.5 H 31 SH 18.25														
COM Yardage: 1 or 2 seats: .75 yard Contact Leland Customer Experience for yardage requirements on textiles with repeats. For COL requirements please contact Leland Customer Experience.														

To specify:
 Please refer to pages 3-4 for complete specifying information.
 Specify all products by their product code.

Pricing Effective: January 2024

SLAM SIDE CHAIR, OAK WOOD LEG
 Design: Lievore Altherr Molina, licensed by Sellex

SL12



Slam Side Chair, Oak Wood Leg	MODEL	LIST PRICE
Polypropylene shell, Oak Leg W 22.5 D 21.5 H 31 SH 18	SLWO-PO	\$884

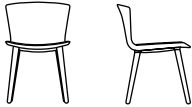

Slam Side Chair, Oak Wood Leg	MODEL	COM/COL	A	B	C	D	E	F	G	H	I	J	K	L
Polypropylene shell, Oak Leg upholstered seat onlay W 22.5 D 21.5 H 31 SH 18.25	SLWO-PU	\$1036	1107	1143	1179	1215	1252	1288	1325	1360	1396	1433	1468	1504

COM Yardage: 1 or 2 seats: .75 yard
 Contact Leland Customer Experience for yardage requirements on textiles with repeats.
 For COL requirements please contact Leland Customer Experience.



Slam Side Chair, Oak Wood Leg	MODEL	COM/COL	A	B	C	D	E	F	G	H	I	J	K	L
Fully upholstered, Oak Leg W 22.5 D 21.5 H 31 SH 18.25	SLWO-FU	\$1113	1239	1301	1364	1427	1490	1553	1616	1678	1741	1804	1867	1930

COM Yardage: 1 seat: 1.5 yards
 Contact Leland Customer Experience for yardage requirements on textiles with repeats.
 For COL requirements please contact Leland Customer Experience.

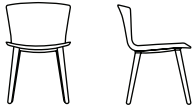

Slam Side Chair, Oak Wood Leg	MODEL	LIST PRICE
3D Oak veneer shell, Oak Leg W 22.5 D 21.5 H 31 SH 18	SLWO-3DO	\$1798



Slam Side Chair, Oak Wood Leg	MODEL	COM/COL	A	B	C	D	E	F	G	H	I	J	K	L
3D Oak veneer shell, Oak Leg upholstered seat onlay W 22.5 D 21.5 H 31 SH 18.25	SLWO-3OU	\$2019	2100	2142	2182	2224	2268	2308	2349	2392	2432	2475	2517	2557

COM Yardage: 1 or 2 seats: .75 yard
 Contact Leland Customer Experience for yardage requirements on textiles with repeats.
 For COL requirements please contact Leland Customer Experience.

To specify:
 Please refer to pages 3-4 for complete specifying information.
 Specify all products by their product code.

SLAM STACKING 4-LEG MOBILE BASE CHAIR
 Design: Lievore Altherr Molina, licensed by Sellex

SL13



Slam Stacking

4-Leg Mobile Base Chair

	MODEL	FRAME FINISH	LIST PRICE
Polypropylene shell w/ casters	SLM-PO	Powder Coat	\$786
W 20.75 D 19.75 H 31.75 SH 18.25		Chrome	\$855



Slam Stacking

4-Leg Mobile Base Chair

	MODEL	LIST PRICE/ GRADE	COM/COL	A	B	C	D	E	F	G	H	I	J	K	L
Polypropylene shell, upholstered seat onlay, w/ casters	SLM-PU	Powder Coat	\$969	1039	1076	1111	1148	1185	1220	1257	1293	1328	1365	1401	1436
		Chrome	\$1035	1106	1142	1177	1214	1250	1288	1323	1359	1396	1431	1467	1504
W 20.75 D 19.75 H 31.75 SH 18.5		COM Yardage: 1 or 2 seats: .75 yard Contact Leland Customer Experience for yardage requirements on textiles with repeats. For COL requirements please contact Leland Customer Experience.													



Slam Stacking

4-Leg Mobile Base Chair

	MODEL	LIST PRICE/ GRADE	COM/COL	A	B	C	D	E	F	G	H	I	J	K	L
Fully upholstered w/ casters	SLM-FU	Powder Coat	\$1043	1169	1231	1294	1357	1420	1483	1545	1608	1671	1734	1797	1860
		Chrome	\$1112	1238	1300	1363	1426	1489	1552	1615	1677	1740	1803	1866	1929
W 20.75 D 19.75 H 31.75 SH 18.5		COM Yardage: 1 seat: 1.5 yards Contact Leland Customer Experience for yardage requirements on textiles with repeats. For COL requirements please contact Leland Customer Experience.													

To specify:

Please refer to pages 3-4 for complete specifying information.
 Specify all products by their product code.

Pricing Effective: January 2024

SLAM STACKING 4-LEG MOBILE BASE CHAIR
 Design: Lievore Altherr Molina, licensed by Sellex

SL14



Slam Stacking

4-Leg Mobile Base Chair

	MODEL	FRAME FINISH	LIST PRICE
3D Beech veneer shell w/ casters	SLM-3DB	Powder Coat	\$1425
W 20.75 D 19.75 H 31.75 SH 18.25		Chrome	\$1495



Slam Stacking

4-Leg Mobile Base Chair

	MODEL	LIST PRICE/ GRADE	COM/COL	A	B	C	D	E	F	G	H	I	J	K	L
3D Beech veneer shell, upholstered seat onlay, w/ casters	SLM-3BU	Powder Coat	\$1605	1676	1712	1750	1785	1823	1859	1894	1931	1967	2002	2040	2076
		Chrome	\$1674	1745	1782	1818	1854	1891	1927	1963	1999	2035	2071	2108	2145
W 20.75 D 19.75 H 31.75 SH 18.5		COM Yardage: 1 or 2 seats: .75 yard Contact Leland Customer Experience for yardage requirements on textiles with repeats. For COL requirements please contact Leland Customer Experience.													



Slam Stacking

4-Leg Mobile Base Chair

	MODEL	FRAME FINISH	LIST PRICE
3D Oak veneer shell w/ casters	SLM-3DO	Powder Coat	\$1602
W 20.75 D 19.75 H 31.75 SH 18.25		Chrome	\$1672



Slam Stacking

4-Leg Mobile Base Chair

	MODEL	LIST PRICE/ GRADE	COM/COL	A	B	C	D	E	F	G	H	I	J	K	L
3D Beech veneer shell, upholstered seat onlay, w/ casters	SLM-3OU	Powder Coat	\$1782	1853	1890	1926	1962	1998	2034	2070	2107	2143	2179	2215	2252
		Chrome	\$1851	1924	1959	1996	2032	2068	2104	2140	2177	2213	2249	2285	2321
W 20.75 D 19.75 H 31.75 SH 18.5		CCOM Yardage: 1 or 2 seats: .75 yard Contact Leland Customer Experience for yardage requirements on textiles with repeats. For COL requirements please contact Leland Customer Experience.													

To specify:

Please refer to pages 3-4 for complete specifying information. Specify all products by their product code.

SLAM STACKING MOBILE ARM CHAIR
 Design: Lievore Altherr Molina, licensed by Sellex

SL15



**Slam Stacking
 Mobile Arm Chair**

	MODEL	FRAME FINISH	LIST PRICE
Polypropylene Shell w/ casters	SLMA-PO	Powder Coat	\$941

W 20.75 D 19.75 H 31 .75
 SH 18.5



**Slam Stacking
 Mobile Arm Chair**

	MODEL	LIST PRICE/ GRADE	COM/COL	A	B	C	D	E	F	G	H	I	J	K	L
Polypropylene shell, upholstered seat onlay, w/ casters	SLMA-PU	Powder Coat	\$1123	1193	1230	1265	1302	1339	1375	1412	1448	1483	1520	1556	1591

W 20.75 D 19.75 H 31 .75
 SH 18.5

COM Yardage: 1 or 2 seats: .75 yard
 Contact Leland Customer Experience for yardage requirements on textiles with repeats.
 For COL requirements please contact Leland Customer Experience.



**Slam Stacking
 Mobile Arm Chair**

	MODEL	LIST PRICE/ GRADE	COM/COL	A	B	C	D	E	F	G	H	I	J	K	L
Fully upholstered w/ casters	SLMA-FU	Powder Coat	\$1197	1323	1386	1449	1512	1574	1637	1700	1763	1826	1888	1951	2014

W 20.75 D 19.75 H 31 .75
 SH 18.5

COM Yardage: 1 seat: 1.5 yards
 Contact Leland Customer Experience for yardage requirements on textiles with repeats.
 For COL requirements please contact Leland Customer Experience.

To specify:
 Please refer to pages 3-4 for complete specifying information.
 Specify all products by their product code.

Pricing Effective: January 2024

SLAM STACKING MOBILE ARM CHAIR
 Design: Lievore Altherr Molina, licensed by Sellex

SL16



Slam Stacking

Mobile Arm Chair

	MODEL	FRAME FINISH	LIST PRICE
3D Beech veneer shell w/ casters	SLMA-3DB	Powder Coat	\$1579

W 20.75 D 19.75 H 31.75
 SH 18.25



Slam Stacking

Mobile Arm Chair

	MODEL	LIST PRICE/ GRADE	COM/COL	A	B	C	D	E	F	G	H	I	J	K	L
3D Beech veneer shell, upholstered seat onlay, w/ casters	SLMA-3BU	Powder Coat	\$1760	1831	1867	1905	1940	1977	2013	2048	2085	2121	2156	2194	2230

W 20.75 D 19.75 H 31.75
 SH 18.5

COM Yardage: 1 or 2 seats: .75 yard
 Contact Leland Customer Experience for yardage requirements on textiles with repeats.
 For COL requirements please contact Leland Customer Experience.



Slam Stacking

Mobile Arm Chair

	MODEL	FRAME FINISH	LIST PRICE
3D Oak veneer shell w/ casters	SLMA-3DO	Powder Coat	\$1757

W 20.75 D 19.75 H 31.75
 SH 18.25



Slam Stacking

Mobile Arm Chair

	MODEL	LIST PRICE/ GRADE	COM/COL	A	B	C	D	E	F	G	H	I	J	K	L
3D Beech veneer shell, upholstered seat onlay, w/ casters	SLMA-3OU	Powder Coat	\$1937	2008	2044	2080	2116	2152	2188	2224	2261	2297	2333	2369	2407

W 20.75 D 19.75 H 31.75
 SH 18.5

CCOM Yardage: 1 or 2 seats: .75 yard
 Contact Leland Customer Experience for yardage requirements on textiles with repeats.
 For COL requirements please contact Leland Customer Experience.

To specify:
 Please refer to pages 3-4 for
 complete specifying information.
 Specify all products by their
 product code.

SLAM SIDE CHAIR, ALUMINUM BASE
 Design: Lievore Altherr Molina, licensed by Sellex

SL17



Slam Side Chair

Aluminum Base

	MODEL	FRAME FINISH	LIST PRICE
Polypropylene shell	SLA-PO	Powder Coat	\$809
W 20.75 D 20.75 H 31.75 SH 18		Polished Aluminum	\$1424



Slam Side Chair

Aluminum Base

	MODEL	LIST PRICE/GRADE	COM/COL	A	B	C	D	E	F	G	H	I	J	K	L
Polypropylene shell upholstered seat onlay	SLA-PU	Powder Coat	\$961	1034	1070	1107	1143	1178	1215	1251	1286	1323	1359	1397	1432
		Polished Aluminum	\$1576	1647	1684	1722	1757	1793	1830	1865	1902	1938	1973	2011	2047
W 20.75 D 20.75 H 31.75 SH 18.25			COM Yardage: 1 or 2 seats: .75 yard Contact Leland Customer Experience for yardage requirements on textiles with repeats.												



Slam Side Chair

Aluminum Base

	MODEL	LIST PRICE/GRADE	COM/COL	A	B	C	D	E	F	G	H	I	J	K	L
Fully upholstered	SLA-FU	Powder Coat	\$1038	1163	1226	1289	1352	1415	1478	1540	1603	1666	1729	1792	1854
W 20.75 D 20.75 H 31.75 SH 18.25		Polished Aluminum	\$1653	1778	1841	1904	1967	2030	2092	2155	2218	2281	2344	2407	2469
			COM Yardage: 1 seat: 1.5 yards Contact Leland Customer Experience for yardage requirements on textiles with repeats.												

To specify:

Please refer to pages 3-4 for complete specifying information. Specify all products by their product code.

Pricing Effective: January 2024

SLAM SIDE CHAIR, ALUMINUM BASE
 Design: Lievore Altherr Molina, licensed by Sellex

SL18



Slam Side Chair

Aluminum Base

	MODEL	FRAME FINISH	LIST PRICE
3D Beech veneer shell, aluminum base	SLA-3DB	Powder Coat	\$1451
		Polished Aluminum	\$2063
W 20.75 D 20.75 H 31.75 SH 18			



Slam Side Chair

Aluminum Base

	MODEL	LIST PRICE/GRADE	COM/COL	A	B	C	D	E	F	G	H	I	J	K	L
3D Beech veneer shell, upholstered seat onlay, aluminum base	SLA-3BU	Powder Coat	\$1601	1672	1708	1744	1780	1816	1852	1888	1926	1962	1998	2034	2071
		Polished Aluminum	\$2214	2287	2322	2358	2395	2430	2466	2503	2538	2577	2613	2648	2685
W 20.75 D 20.75 H 31.75 SH 18.25				Optional Glides: Add \$8.00 net per chair for a set of four (4). Optional Glides raise chair height .5 inch. COM Yardage: 1 or 2 seats: .75 yard Contact Leland Customer Experience for yardage requirements on textiles with repeats.											



Slam Side Chair

Aluminum Base

	MODEL	FRAME FINISH	LIST PRICE
3D Oak veneer shell, aluminum base	SLA-3DO	Powder Coat	\$1627
		Polished Aluminum	\$2240
W 20.75 D 20.75 H 31.75 SH 18			



Slam Side Chair

Aluminum Base

	MODEL	LIST PRICE/GRADE	COM/COL	A	B	C	D	E	F	G	H	I	J	K	L
3D Oak veneer shell, upholstered seat onlay, aluminum base	SLA-3OU	Powder Coat	\$1776	1847	1883	1920	1955	1991	2030	2065	2102	2138	2173	2210	2246
		Polished Aluminum	\$2391	2462	2497	2534	2570	2607	2643	2680	2717	2752	2788	2825	2860
W 20.75 D 20.75 H 31.75 SH 18.25				Optional Glides: Add \$8.00 net per chair for a set of four (4). Optional Glides raise chair height .5 inch. COM Yardage: 1 or 2 seats: .75 yard Contact Leland Customer Experience for yardage requirements on textiles with repeats.											

To specify:

Please refer to pages 3-4 for complete specifying information. Specify all products by their product code.

Pricing Effective: January 2024

SLAM ARM CHAIR, ALUMINUM BASE
 Design: Lievore Altherr Molina, licensed by Sellex

SL19



Slam Arm Chair

Aluminum Base

	MODEL	FRAME FINISH	LIST PRICE
Polypropylene shell	SLAA-PO	Powder Coat	\$906
W 25 D 20.75 H 31.75 SH 18 AH 25.5		Polished Aluminum	\$1573



Slam Arm Chair

Aluminum Base

	MODEL	LIST PRICE/GRADE	COM/COL	A	B	C	D	E	F	G	H	I	J	K	L
Polypropylene shell upholstered seat onlay	SLAA-PU	Powder Coat	\$1057	1128	1164	1201	1236	1274	1311	1346	1383	1419	1454	1491	1527
		Polished Aluminum	\$1723	1793	1830	1865	1902	1938	1973	2011	2047	2082	2119	2155	2190
W 25 D 20.75 H 31.75 SH 18.25 AH 25.5			COM Yardage: 1 or 2 seats: .75 yard Contact Leland Customer Experience for yardage requirements on textiles with repeats.												



Slam Arm Chair

Aluminum Base

	MODEL	LIST PRICE/GRADE	COM/COL	A	B	C	D	E	F	G	H	I	J	K	L
Fully upholstered	SLAA-FU	Powder Coat	\$1135	1260	1323	1386	1449	1512	1574	1637	1700	1763	1826	1888	1951
W 25 D 20.75 H 31.75 SH 18.25 AH 25.5		Polished Aluminum	\$1802	1928	1990	2053	2116	2179	2242	2305	2367	2430	2493	2556	2619
			COM Yardage: 1.5 yards Contact Leland Customer Experience for yardage requirements on textiles with repeats.												

To specify:

Please refer to pages 3-4 for complete specifying information. Specify all products by their product code.

Pricing Effective: January 2024

SLAM ARM CHAIR, ALUMINUM BASE
 Design: Lievore Altherr Molina, licensed by Sellex

SL20



Slam Arm Chair

Aluminum Base	MODEL	FRAME FINISH	LIST PRICE
3D Beech veneer shell	SLAA-3DB	Powder Coat	\$1543
W 25 D 20.75 H 31.75 SH 18 AH 25.5		Polished Aluminum	\$2210



Slam Arm Chair

Aluminum Base	MODEL	LIST PRICE/GRADE	COM/COL	A	B	C	D	E	F	G	H	I	J	K	L
3D Beech veneer shell, upholsteredseat onlay, aluminum base	SLAA-3BU	Powder Coat	\$1695	1767	1802	1838	1876	1911	1948	1984	2019	2056	2092	2127	2166
		Polished Aluminum	\$2361	2431	2468	2504	2540	2578	2614	2649	2686	2722	2757	2794	2830
W 25 D 20.75 H 31.75 SH 18.25 AH 25.5		Optional Glides: Add \$8.00 net per chair for a set of four (4). Optional Glides raise chair height .5 inch. COM Yardage: 1 or 2 seats: .75 yard Contact Leland Customer Experience for yardage requirements on textiles with repeats.													



Slam Arm Chair

Aluminum Base	MODEL	FRAME FINISH	LIST PRICE
3D Oak veneer shell, aluminum base	SLAA-3DO	Powder Coat	\$1722
W 25 D 20.75 H 31.75 SH 18 AH 25.5		Polished Aluminum	\$2384



Slam Arm Chair

Aluminum Base	MODEL	LIST PRICE/GRADE	COM/COL	A	B	C	D	E	F	G	H	I	J	K	L
3D Oak veneer shell, upholsteredseat onlay, aluminum base	SLAA-3OU	Powder Coat	\$1872	1943	1980	2015	2051	2088	2123	2159	2196	2231	2270	2306	2341
		Polished Aluminum	\$2536	2608	2645	2681	2718	2753	2789	2826	2861	2898	2935	2970	3007
W 25 D 20.75 H 31.75 SH 18.25 AH 25.5		Optional Glides: Add \$8.00 net per chair for a set of four (4). Optional Glides raise chair height .5 inch. COM Yardage: 1 or 2 seats: .75 yard Contact Leland Customer Experience for yardage requirements on textiles with repeats.													

To specify:
 Please refer to pages 3-4 for complete specifying information.
 Specify all products by their product code.

SLAM TASK BASE CHAIR
 Design: Lievore Altherr Molina, licensed by Sellex

SL21

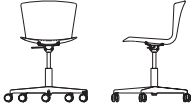

Slam Task Base Chair	MODEL	FRAME FINISH	LIST PRICE
Polypropylene shell	SLTB-PO	Powder Coat	\$912

W 20.75 D 20.75
 H 31.75-35.75 SH 18.5-22.5

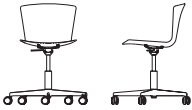

Slam Task Base Chair	MODEL	LIST PRICE/GRADE	COM/COL	A	B	C	D	E	F	G	H	I	J	K	L
Polypropylene shell, upholstered seat onlay	SLTB-PU	Powder Coat	\$1062	1108	1129	1152	1175	1197	1219	1243	1264	1286	1311	1332	1355

W 20.75 D 20.75
 H 31.75-35.75 SH 18.5-22.5

COM Yardage: 1 or 2 seats: .75 yard
 Contact Leland Customer Experience for yardage requirements on textiles with repeats.

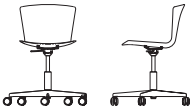

Slam Task Base Chair	MODEL	LIST PRICE/GRADE	COM/COL	A	B	C	D	E	F	G	H	I	J	K	L
Fully upholstered	SLTB-FU	Powder Coat	\$1141	1266	1329	1392	1455	1518	1581	1643	1706	1769	1832	1895	1957

W 20.75 D 20.75
 H 31.75-35.75 SH 18.5-22.5

COM Yardage: 1 seat: 1.5 yards
 Contact Leland Customer Experience for yardage requirements on textiles with repeats.

To specify:
 Please refer to pages 3-4 for complete specifying information.
 Specify all products by their product code.

SLAM TASK BASE CHAIR
 Design: Lievore Altherr Molina, licensed by Sellex

SL22

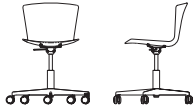

Slam Task Base Chair	MODEL	FRAME FINISH	LIST PRICE
3D Beech veneer shell	SLTB-3DB	Powder Coat	\$1551

W 20.75 D 20.75
 H 31.75-35.75 SH 18.5-22.5

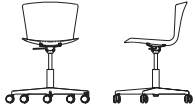

Slam Task Base Chair	MODEL	LIST PRICE/GRADE	COM/COL	A	B	C	D	E	F	G	H	I	J	K	L
3D Beech veneer shell, upholstered seat onlay	SLTB-3BU	Powder Coat	\$1704	1748	1770	1793	1815	1837	1861	1882	1905	1928	1950	1972	1996

W 20.75 D 20.75
 H 31.75-35.75 SH 18.5-22.5

COM Yardage: 1 or 2 seats: .75 yard
 Contact Leland Customer Experience for yardage requirements on textiles with repeats.

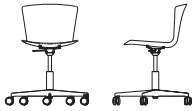

Slam Task Base Chair	MODEL	FRAME FINISH	LIST PRICE
3D Oak veneer shell	SLTB-3DO	Powder Coat	\$1726

W 20.75 D 20.75
 H 31.75-35.75 SH 18.5-22.5



Slam Task Base Chair	MODEL	LIST PRICE/GRADE	COM/COL	A	B	C	D	E	F	G	H	I	J	K	L
3D Oak veneer shell, upholstered seat onlay	SLTB-3OU	Powder Coat	\$1879	1924	1946	1969	1990	2014	2036	2058	2081	2104	2125	2149	2171

W 20.75 D 20.75
 H 31.75-35.75 SH 18.5-22.5

COM Yardage: 1 or 2 seats: .75 yard
 Contact Leland Customer Experience for yardage requirements on textiles with repeats.

To specify:
 Please refer to pages 3-4 for complete specifying information.
 Specify all products by their product code.

Pricing Effective: January 2024

SLAM SLED COUNTER CHAIR
 Design: Lievore Altherr Molina, licensed by Sellex

SL23



Slam Sled

Counter Chair

	MODEL	FRAME FINISH	LIST PRICE
Polypropylene shell	SLCS-PO	Powder Coat	\$729
W 22 D 20.75 H 39 SH 25		Chrome	\$809

Optional Glides: Add \$8.00 net per chair for a set of four (4).



Slam Sled

Counter Chair

	MODEL	LIST PRICE/GRADE	COM/COL	A	B	C	D	E	F	G	H	I	J	K	L
Polypropylene shell, upholstered seat onlay,	SLCS-PU	Powder Coat	\$882	953	989	1024	1061	1097	1132	1170	1206	1243	1279	1315	1351
		Chrome	\$961	1034	1070	1107	1143	1178	1215	1251	1286	1323	1359	1397	1432

W 22 D 20.75
 H 39 SH 25.25

COM Yardage: 1 or 2 seats: .75 yard
 Contact Leland Customer Experience for yardage requirements on textiles with repeats.
 Optional Glides: Add \$8.00 net per chair for a set of four (4).



Slam Sled

Counter Chair

	MODEL	LIST PRICE/GRADE	COM/COL	A	B	C	D	E	F	G	H	I	J	K	L
Fully upholstered	SLCS-FU	Powder Coat	\$957	1083	1146	1209	1272	1334	1397	1460	1523	1586	1648	1711	1774
		Chrome	\$1038	1163	1226	1289	1352	1415	1478	1540	1603	1666	1729	1792	1854

W 22 D 20.75
 H 39 SH 25.25

COM Yardage: 1.5 yards
 Contact Leland Customer Experience for yardage requirements on textiles with repeats.
 Optional Glides: Add \$8.00 net per chair for a set of four (4).

To specify:
 Please refer to pages 3-4 for complete specifying information.
 Specify all products by their product code.

Pricing Effective: January 2024

SLAM SLED COUNTER CHAIR
 Design: Lievore Altherr Molina, licensed by Sellex

SL24



Slam Sled

Counter Chair	MODEL	FRAME FINISH	LIST PRICE
3D Beech veneer shell	SLCS-3DB	Powder Coat	\$1368
W 22 D 20.75 H 39 SH 25		Chrome	\$1451

Optional Glides: Add \$8.00 net per chair for a set of four (4).



Slam Sled

Counter Chair	MODEL	LIST PRICE/GRADE	COM/COL	A	B	C	D	E	F	G	H	I	J	K	L
3D Beech veneer shell, upholstered seat onlay	SLCS-3BU	Powder Coat	\$1517	1588	1624	1661	1696	1733	1769	1805	1842	1878	1913	1950	1986
		Chrome	\$1601	1672	1708	1744	1780	1816	1852	1888	1926	1962	1998	2034	2071

W 22 D 20.75
 H 39 SH 25.25

COM Yardage: 1 or 2 seats: .75 yard
 Contact Leland Customer Experience for yardage requirements on textiles with repeats.
 Optional Glides: Add \$8.00 net per chair for a set of four (4).



Slam Sled

Counter Chair	MODEL	FRAME FINISH	LIST PRICE
3D Oak veneer shell	SLCS-3DO	Powder Coat	\$1543
W 22 D 20.75 H 39 SH 25		Chrome	\$1627

Optional Glides: Add \$8.00 net per chair for a set of four (4).



Slam Sled

Counter Chair	MODEL	LIST PRICE/GRADE	COM/COL	A	B	C	D	E	F	G	H	I	J	K	L
3D Oak veneer shell, upholstered seat onlay	SLCS-3OU	Powder Coat	\$1693	1765	1800	1836	1873	1909	1945	1982	2017	2053	2090	2125	2162
		Chrome	\$1776	1847	1883	1920	1955	1991	2030	2065	2102	2138	2173	2210	2246

W 22 D 20.75
 H 39 SH 25.25

COM Yardage: 1 or 2 seats: .75 yard
 Contact Leland Customer Experience for yardage requirements on textiles with repeats.
 Optional Glides: Add \$8.00 net per chair for a set of four (4).

To specify:
 Please refer to pages 3-4 for complete specifying information.
 Specify all products by their product code.

SLAM 4-LEG COUNTER CHAIR
 Design: Lievore Altherr Molina, licensed by Sellex

SL25



Slam 4-Leg Counter Chair

	MODEL	FRAME FINISH	LIST PRICE
Polypropylene shell	SLC4-PO	Powder Coat	\$952
W 22 D 19.75 H 37 SH 25		Chrome	\$1030

Optional Glides: Add \$8.00 net per chair for a set of four (4). Optional Glides raise chair height .5 inch.



Slam 4-Leg Counter Chair

	MODEL	LIST PRICE/GRADE	COM/COL	A	B	C	D	E	F	G	H	I	J	K	L
Polypropylene shell, upholstered seat onlay	SLC4-PU	Powder Coat	\$1102	1174	1210	1247	1282	1318	1355	1390	1427	1464	1499	1536	1572
		Chrome	\$1183	1253	1290	1325	1362	1399	1434	1470	1507	1542	1579	1616	1652

W 22 D 19.75
 H 37.25 SH 25.25

Optional Glides: Add \$8.00 net per chair for a set of four (4). Optional Glides raise chair height .5 inch.
 COM Yardage: 1 or 2 seats: .75 yard
 Contact Leland Customer Experience for yardage requirements on textiles with repeats.
 For COL requirements please contact Leland Customer Experience.



Slam 4-Leg Counter Chair

	MODEL	LIST PRICE/GRADE	COM/COL	A	B	C	D	E	F	G	H	I	J	K	L
Fully upholstered	SLC4-FU	Powder Coat	\$1181	1307	1369	1432	1495	1558	1621	1684	1746	1809	1872	1935	1998
		Chrome	\$1259	1385	1448	1510	1573	1636	1699	1762	1825	1887	1950	2013	2076

W 22 D 19.75
 H 37.25 SH 25.25

Optional Glides: Add \$8.00 net per chair for a set of four (4). Optional Glides raise chair height .5 inch.
 COM Yardage: 1.5 yards
 Contact Leland Customer Experience for yardage requirements on textiles with repeats.
 For COL requirements please contact Leland Customer Experience.

To specify:
 Please refer to pages 3-4 for complete specifying information.
 Specify all products by their product code.

SLAM 4-LEG COUNTER CHAIR
 Design: Lievore Altherr Molina, licensed by Sellex

SL26



Slam 4-Leg Counter Chair

	MODEL	FRAME FINISH	LIST PRICE
3D Beech veneer shell	SLC4-3DB	Powder Coat	\$1591
W 22 D 19.75 H 37 SH 25		Chrome	\$1669

Optional Glides: Add \$8.00 net per chair for a set of four (4). Optional Glides raise chair height .5 inch.



Slam 4-Leg Counter Chair

	MODEL	LIST PRICE/GRADE	COM/COL	A	B	C	D	E	F	G	H	I	J	K	L
3D Beech veneer shell, upholstered seat onlay	SLC4-3BU	Powder Coat	\$1740	1812	1847	1883	1920	1955	1991	2030	2065	2102	2138	2173	2210
		Chrome	\$1819	1892	1928	1965	2000	2036	2073	2108	2144	2182	2218	2254	2290

W 22 D 19.75
 H 37.25 SH 25.25

Optional Glides: Add \$8.00 net per chair for a set of four (4). Optional Glides raise chair height .5 inch.
 COM Yardage: 1 or 2 seats: .75 yard
 Contact Leland Customer Experience for yardage requirements on textiles with repeats.
 For COL requirements please contact Leland Customer Experience.



Slam 4-Leg Counter Chair

	MODEL	FRAME FINISH	LIST PRICE
3D Oak veneer shell	SLC4-3DO	Powder Coat	\$1767
W 22 D 19.75 H 37 SH 25		Chrome	\$1845

Optional Glides: Add \$8.00 net per chair for a set of four (4). Optional Glides raise chair height .5 inch.



Slam 4-Leg Counter Chair

	MODEL	LIST PRICE/GRADE	COM/COL	A	B	C	D	E	F	G	H	I	J	K	L
3D Oak veneer shell, upholstered seat onlay	SLC4-3OU	Powder Coat	\$1917	1987	2024	2059	2097	2134	2169	2205	2242	2277	2313	2350	2385
		Chrome	\$1998	2069	2105	2141	2178	2213	2249	2287	2322	2358	2395	2430	2466

W 22 D 19.75
 H 37.25 SH 25.25

Optional Glides: Add \$8.00 net per chair for a set of four (4). Optional Glides raise chair height .5 inch.
 COM Yardage: 1 or 2 seats: .75 yard
 Contact Leland Customer Experience for yardage requirements on textiles with repeats.
 For COL requirements please contact Leland Customer Experience.

To specify:
 Please refer to pages 3-4 for complete specifying information.
 Specify all products by their product code.

SLAM SLED BAR CHAIR
 Design: Lievore Altherr Molina, licensed by Sellex

SL27



Slam Sled Bar Chair	MODEL	FRAME FINISH	LIST PRICE
Polypropylene shell W 22 D 20.75 H 43 SH 30	SLBS-PO	Powder Coat	\$820
		Chrome	\$891

Optional Glides: Add \$8.00 net per chair for a set of four (4).



Slam Sled Bar Chair	MODEL	LIST PRICE/GRADE	COM/COL	A	B	C	D	E	F	G	H	I	J	K	L
Polypropylene shell, upholsteredseat onlay W 22 D 20.75 H 43 SH 30.25	SLBS-PU	Powder Coat	\$912	985	1020	1056	1093	1128	1164	1201	1236	1274	1311	1346	1383
		Chrome	\$982	1054	1090	1126	1162	1198	1234	1270	1307	1344	1380	1416	1452

COM Yardage: 1 or 2 seats: .75 yard
 Contact Leland Customer Experience for yardage requirements on textiles with repeats.
 Optional Glides: Add \$8.00 net per chair for a set of four (4).

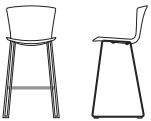

Slam Sled Bar Chair	MODEL	LIST PRICE/GRADE	COM/COL	A	B	C	D	E	F	G	H	I	J	K	L
Fully upholstered W 22 D 20.75 H 43 SH 30.25	SLBS-FU	Powder Coat	\$1049	1175	1238	1300	1363	1426	1489	1552	1615	1677	1740	1803	1866
		Chrome	\$1120	1246	1309	1371	1434	1497	1560	1623	1686	1748	1811	1874	1937

COM Yardage: 1.5 yards
 Contact Leland Customer Experience for yardage requirements on textiles with repeats.
 Optional Glides: Add \$8.00 net per chair for a set of four (4).

To specify:
 Please refer to pages 3-4 for complete specifying information.
 Specify all products by their product code.

Pricing Effective: January 2024

SLAM SLED BAR CHAIR

Design: Lievore Altherr Molina, licensed by Sellex

SL28



Slam Sled Bar Chair	MODEL	FRAME FINISH	LIST PRICE
3D Beech veneer shell W 22 D 20.75 H 43 SH 30	SLBS-3DB	Powder Coat	\$1459
		Chrome	\$1532

Optional Glides: Add \$8.00 net per chair for a set of four (4).



Slam Sled Bar Chair	MODEL	LIST PRICE/GRADE	COM/COL	A	B	C	D	E	F	G	H	I	J	K	L
3D Beech veneer shell, upholstered seat onlay W 22 D 20.75 H 43 SH 30.25	SLBS-3BU	Powder Coat	\$1610	1681	1718	1755	1791	1827	1863	1899	1935	1971	2007	2043	2080
		Chrome	\$1799	1870	1906	1943	1980	2015	2051	2088	2123	2159	2196	2231	2270

COM Yardage: 1 or 2 seats: .75 yard
Contact Leland Customer Experience for yardage requirements on textiles with repeats.
Optional Glides: Add \$8.00 net per chair for a set of four (4).



Slam Sled Bar Chair	MODEL	FRAME FINISH	LIST PRICE
3D Oak veneer shell W 22 D 20.75 H 43 SH 30	SLBS-3DO	Powder Coat	\$1636
		Chrome	\$1708

Optional Glides: Add \$8.00 net per chair for a set of four (4).



Slam Sled Bar Chair	MODEL	LIST PRICE/GRADE	COM/COL	A	B	C	D	E	F	G	H	I	J	K	L
3D Oak veneer shell, upholstered seat onlay W 22 D 20.75 H 43 SH 30.25	SLBS-3OU	Powder Coat	\$1787	1859	1895	1930	1967	2003	2039	2075	2111	2148	2184	2220	2256
		Chrome	\$1623	1694	1730	1767	1802	1838	1876	1911	1948	1984	2019	2056	2092

COM Yardage: 1 or 2 seats: .75 yard
Contact Leland Customer Experience for yardage requirements on textiles with repeats.
Optional Glides: Add \$8.00 net per chair for a set of four (4).

To specify:
Please refer to pages 3-4 for complete specifying information.
Specify all products by their product code.

SLAM 4-LEG BAR CHAIR
 Design: Lievore Altherr Molina, licensed by Sellex

SL29



Slam 4-Leg Bar Chair	MODEL	FRAME FINISH	LIST PRICE
Polypropylene shell W 22 D 19.75 H 43 SH 30	SLB4-PO	Powder Coat	\$971
		Chrome	\$1052

Optional Glides: Add \$8.00 net per chair for a set of four (4).



Slam 4-Leg Bar Chair	MODEL	LIST PRICE/GRADE	COM/COL	A	B	C	D	E	F	G	H	I	J	K	L
Polypropylene shell, upholsteredseat onlay W 22 D 19.75 H 43.25 SH 30.25	SLB4-PU	Powder Coat	\$1122	1192	1229	1264	1300	1337	1372	1409	1447	1483	1519	1555	1591
		Chrome	\$1201	1272	1308	1345	1382	1418	1453	1490	1526	1561	1598	1635	1670

Optional Glides: Add \$8.00 net per chair for a set of four (4). Optional Glides raise chair height .5 inch.
 COM Yardage: 1 or 2 seats: .75 yard
 Contact Leland Customer Experience for yardage requirements on textiles with repeats.
 For COL requirements please contact Leland Customer Experience.



Slam 4-Leg Bar Chair	MODEL	LIST PRICE/GRADE	COM/COL	A	B	C	D	E	F	G	H	I	J	K	L
Fully upholstered W 22 D 19.75 H 43.25 SH 30.25	SLB4-FU	Powder Coat	\$1199	1325	1388	1451	1514	1576	1639	1702	1765	1828	1891	1953	2016
		Chrome	\$1281	1406	1469	1532	1595	1658	1721	1783	1846	1909	1972	2035	2098

Optional Glides: Add \$8.00 net per chair for a set of four (4). Optional Glides raise chair height .5 inch.
 COM Yardage: 1.5 yards
 Contact Leland Customer Experience for yardage requirements on textiles with repeats.
 For COL requirements please contact Leland Customer Experience.

To specify:
 Please refer to pages 3-4 for complete specifying information.
 Specify all products by their product code.

SLAM SLED BAR CHAIR

Design: Lievore Altherr Molina, licensed by Sellex

SL30



Slam 4-Leg Bar Chair	MODEL	FRAME FINISH	LIST PRICE
3D Beech veneer shell	SLB4-3DB	Powder Coat	\$1606
W 22 D 19.75 H 43 SH 30		Chrome	\$1689

Optional Glides: Add \$8.00 net per chair for a set of four (4). Optional Glides raise chair height .5 inch.



Slam 4-Leg Bar Chair	MODEL	LIST PRICE/GRADE	COM/COL	A	B	C	D	E	F	G	H	I	J	K	L
3D Beech veneer shell, upholstered seat onlay	SLB4-3BU	Powder Coat	\$1761	1833	1868	1905	1941	1978	2014	2050	2086	2122	2158	2194	2230
W 22 D 19.75 H 43.25 SH 30.25		Chrome	\$1841	1911	1948	1984	2019	2056	2092	2127	2166	2202	2237	2274	2310

Optional Glides: Add \$8.00 net per chair for a set of four (4). Optional Glides raise chair height .5 inch.
COM Yardage: 1 or 2 seats: .75 yard
Contact Leland Customer Experience for yardage requirements on textiles with repeats.
For COL requirements please contact Leland Customer Experience.



Slam 4-Leg Bar Chair	MODEL	FRAME FINISH	LIST PRICE
3D Oak veneer shell	SLB4-3DO	Powder Coat	\$1783
W 22 D 19.75 H 43 SH 30		Chrome	\$1864

Optional Glides: Add \$8.00 net per chair for a set of four (4). Optional Glides raise chair height .5 inch.



Slam 4-Leg Bar Chair	MODEL	LIST PRICE/GRADE	COM/COL	A	B	C	D	E	F	G	H	I	J	K	L
3D Oak veneer shell, upholstered seat onlay	SLB4-3OU	Powder Coat	\$1938	2009	2046	2081	2118	2154	2189	2226	2262	2297	2334	2372	2408
W 22 D 19.75 H 43.25 SH 30.25		Chrome	\$2016	2088	2123	2159	2196	2231	2270	2306	2341	2378	2414	2449	2486

Optional Glides: Add \$8.00 net per chair for a set of four (4). Optional Glides raise chair height .5 inch.
COM Yardage: 1 or 2 seats: .75 yard
Contact Leland Customer Experience for yardage requirements on textiles with repeats.
For COL requirements please contact Leland Customer Experience..

To specify:
Please refer to pages 3-4 for complete specifying information.
Specify all products by their product code.

SLAM TRANSPORT/STACKING DOLLY
Design: Lievore Altherr Molina, licensed by Sellex

SL31

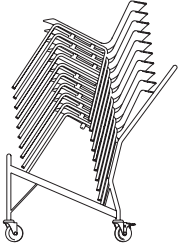

**Slam Transport/
Stacking Dolly**

	MODEL	LIST PRICE
Black powder coat finish	SLD	\$2235
W 25 D 41.25 H 42 (Dimensions of dolly when empty)		
W 26 D 45 H 55 (Dimensions with stack)		

Slam Transport/Stacking Dolly capacity:
4-Leg Base: 10 high on dolly (8 high on floor)
4-Leg Mobile Base: 8 high on dolly (4 high on floor)
**Sled and Aluminum Base does not stack

To specify:
Please refer to pages 3-4 for complete specifying information.
Specify all products by their product code.

Pricing Effective: January 2024

SLAM LOUNGE CHAIR
 Design: Lievore Altherr Molina, licensed by Sellex

SL32



**Slam Lounge
Sled Base**

	MODEL	LIST PRICE/GRADE	COM/COL	A	B	C	D	E	F	G	H	I	J	K	L
Fully upholstered	SLL-S	Powder Coat	\$1227	1326	1381	1437	1492	1545	1600	1657	1711	1766	1821	1877	1931
W 27.5 D 27.5 H 30 SH 17		Chrome	\$1306	1405	1460	1515	1570	1625	1679	1734	1790	1845	1900	1953	2009

Optional Glides: Add \$8.00 net per chair for a set of four (4). Optional Glides raise chair height .5 inch.
 COM Yardage: 1.75 yards per chair
 Contact Leland Customer Experience for yardage requirements on textiles with repeats.
 For COL requirements please contact Leland Customer Experience.



**Slam Lounge
Pyramidal Base**

	MODEL	LIST PRICE/GRADE	COM/COL	A	B	C	D	E	F	G	H	I	J	K	L
Fully upholstered	SLL-P	Powder Coat	\$1780	1880	1935	1990	2046	2100	2154	2210	2265	2320	2375	2429	2484
W 27.5 D 26 H 30 SH 17		Polished Aluminum	\$2457	2556	2609	2666	2721	2775	2830	2887	2941	2995	3049	3106	3161

Optional Glides: Add \$8.00 net per chair for a set of four (4). Optional Glides raise chair height .5 inch.
 COM Yardage: 1.75 yards per chair
 Contact Leland Customer Experience for yardage requirements on textiles with repeats.
 For COL requirements please contact Leland Customer Experience.

To specify:
 Please refer to pages 3-4 for complete specifying information.
 Specify all products by their product code.

**5695 Eagle Drive, SE
Grand Rapids,
Michigan 49512
616-975-9260
lelandfurniture.com**

Slam Beam

January 2024 Price List



Slam Beam

Table of Contents	SB2
Configurative Overview	SB3
Order Diagram	SB4
Visual Reference	SB5
Specification Information	SB8
Specification Example	SB9
Base, Two Position	SB10
Base, Three Position	SB11
Base, Four Position	SB12
Shell Specification Information	SB13
Specification Example	SB14
Shell Selection	SB15
Table Specification Information	SB17
Table Specification Example	SB18
Table	SB19
Floor Mount	SB20

Slam Beam Seating Configuration

Slam Beam can be configured in many ways to meet the needs of your public space. The following pages will provide you a step by step process to correctly configure your benches. **Each purchase order submitted requires the diagram on page SB17 of this price list to be completed for every different bench model.** This is to ensure that the product you receive is exactly what you intended to purchase. If Leland can be of any assistance to you, please don't hesitate to contact our Customer Experience Department at 800-859-7510.

1. Base Selection

Begin configuring Slam Beam by selecting a base. Bases are available in three or four positions, either with arms or armless.

2. Shell Added to Base

The Slam shell is designed to fit one base position. Shells are available in polypropylene or 3D Veneer with or without upholstery. When placing an order, each shell is considered a separate product and will require its own model number.

3. Table Added to Base (Optional)

Slam Beam tables fit one base position. Table surface selections are available as a laminate. When placing an order, each table is considered a separate product and will require its own model number.

Please complete and include with your order. If multiple units are ordered, a diagram must be completed for each unique unit.

1. Slam Beam Base Selection

Select a three position or four position base model number:

The gray boxes below represent the seat/table positions of the model. Specify from left to right as seated. *Note diagram (bottom is front of bench).

TWO (2) POSITION

SB2NA, two position, armless

SB22A, two position, two arm

SB23A, two position, three arm

THREE (3) POSITION

SB3NA, three position, armless

SB32A, three position, two arm

SB34A, three position, four arm

FOUR (4) POSITION

SB4NA, four position, armless

SB42A, four position, two arm

SB45A, four position, five arm

2. SLAM BEAM SHELL AND TABLE SELECTION

Please select either a shell or a table for each position on your base. Then choose the surface materials. Positions should be specified from left to right as seated.

POSITION ONE POSITION TWO

Shell

Polypropylene

Polypropylene

w/ Uph. Seat Onlay

Fully Uph.

Oak 3D Veneer

Oak 3D Veneer w/

Uph. Seat Onlay

Tables

POSITION THREE

Shell

Polypropylene

Polypropylene

w/ Uph. Seat Onlay

Fully Uph.

Oak 3D Veneer

Oak 3D Veneer w/

Uph. Seat Onlay

Tables

POSITION FOUR

Shell

Polypropylene

Polypropylene

w/ Uph. Seat Onlay

Fully Uph.

Oak 3D Veneer

Oak 3D Veneer w/

Uph. Seat Onlay

Tables

POSITION FOUR

Shell

Polypropylene

Polypropylene

w/ Uph. Seat Onlay

Fully Uph.

Oak 3D Veneer

Oak 3D Veneer w/

Uph. Seat Onlay

Tables

TWO POSITION ARMLESS

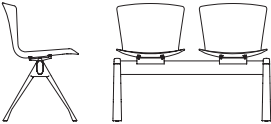

TWO POSITION, TWO ARM

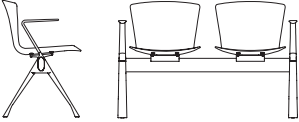

TWO POSITION, THREE ARM

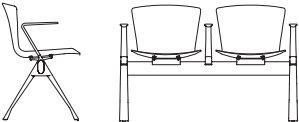

THREE POSITION ARMLESS

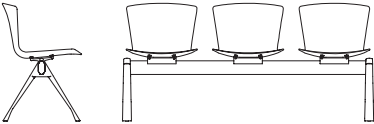

THREE POSITION, TWO ARM

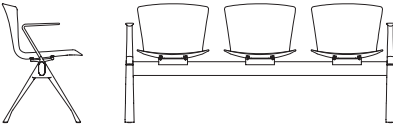

THREE POSITION, FOUR ARM

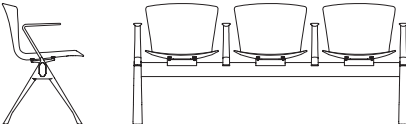

FOUR POSITION ARMLESS

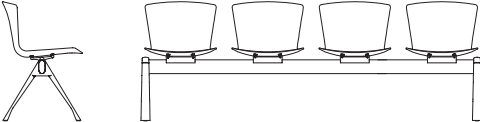

FOUR POSITION, TWO ARM

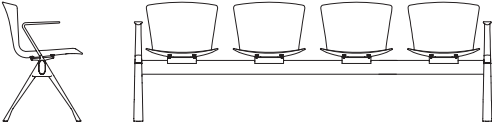

FOUR POSITION, FIVE ARM

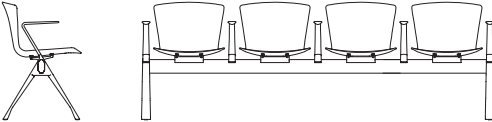

Beam Model

TWO POSITION	CODE
Armless	SB2NA
Two Arm	SB22A
Three Arm	SB23A

THREE POSITION	CODE
Armless	SB3NA
Two Arm	SB32A
Four Arm	SB34A

FOUR POSITION	CODE
Armless	SB4NA
Two Arm	SB42A
Five Arm	SB45A

Beam Finish

DESCRIPTION	CODE
White Textured	WT
Black Textured	BT
Dolphin Textured	DLT
Oxford Textured	OXT
Sterling	ST

Glides

Slam Beam glides are nylon.

Auxiliary Options

DESCRIPTION	CODE
Floor Mount	FM

For a quote on Floor Mount options, please contact Customer Experience.

Freight Note

Due to the size and nature of Slam Beam, the Freight Program does not apply to this product. Please contact Customer Experience for a quote.

Specifications required to create the product code

- Model
- Beam Finish
- Floor Mount (when applicable)



MODEL

Three position,
Armless (SB3NA)

BEAM FINISH

White Textured Powder coat (WT)

FLOOR MOUNT

When applicable, enter Slam Beam
Floor Mount Code (FM)



SLAM BEAM BASE, TWO POSITION
Design: Lievore Altherr Molina, licensed by Sellex

SB10

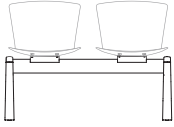

Two Position, Armless	MODEL	LIST PRICE
W 39.25 D 21 H 31	SB2NA Powdercoat	\$2470

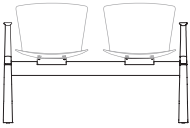

Two Position, Two Arm	MODEL	LIST PRICE
W 43.5 D 21 H 31	SB22A Powdercoat	\$2638

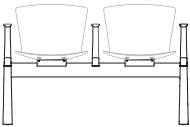

Two Position, Three Arm	MODEL	LIST PRICE
W 43.5 D 21 H 31	SB23A Powdercoat	\$2807

To specify:
Refer to pages SB6-SB7

SLAM BEAM BASE, THREE POSITION
Design: Lievore Altherr Molina, licensed by Sellex

SB11

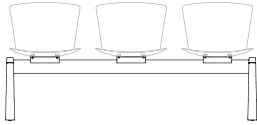

Three Position, Armless	MODEL	LIST PRICE
W 66 D 21 H 31	SB3NA Powdercoat	\$2623

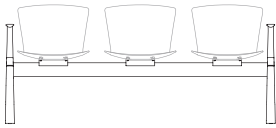

Three Position, Two Arm	MODEL	LIST PRICE
W 70.25 D 21 H 31	SB32A Powdercoat	\$2792

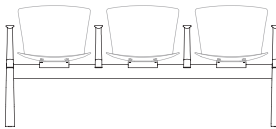

Three Position, Three Arm	MODEL	LIST PRICE
W 70.25 D 21 H 31	SB34A Powdercoat	\$2960

To specify:
Refer to pages SB6-SB7

Pricing Effective: January 2024

SLAM BEAM BASE, FOUR POSITION
 Design: Lievore Altherr Molina, licensed by Sellex

SB12

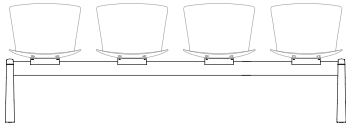

Four Position, Armless	MODEL	LIST PRICE
W 88.5 D 21 H 31	SB4NA Powdercoat	\$3015

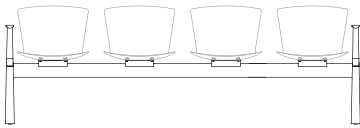

Four Position, Two Arm	MODEL	LIST PRICE
W 93 D 21 H 31	SB42A Powdercoat	\$3184

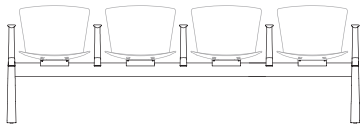

Four Position, Five Arm	MODEL	LIST PRICE
W 93 D 21 H 31	SB45A Powdercoat	\$3438

To specify:
 Refer to pages SB6-SB7

Shell Selection

DESCRIPTION	CODE
Polypropylene	PO
Polypropylene with Upholstered Seat Onlay	PU
Fully Upholstered	FU
Beech 3D Veneer	3DB
Beech 3D Veneer with Upholstered Seat Onlay	3BU
Oak 3D Veneer	3DO
Oak 3D Veneer with Upholstered Seat Onlay	3OU

Shell Finish

POLYPROPYLENE SHELL:

DESCRIPTION	CODE	DESCRIPTION	CODE
White	W	Dolphin	DL
Black	B	Oxford	OX
Fawn	FW	Blue Sky	BS
Fog	FG	Forest	FO
Pine	PN	Pistachio	PS

BEECH 3D VENEER SHELL:

DESCRIPTION	CODE	DESCRIPTION	CODE
Natural Beech	09M	Neutral	15M
Medium	13M	Classic Mahogany	21M
White Wash II	30M	Espresso	23M
Transparent Black	29M	Graphite	25M
Oxford II	49M	Dolphin II	50M
Blue Sky	100M	Forest	101M
Pistachio	110M		

OAK 3D VENEER SHELL:

DESCRIPTION	CODE
Natural White Oak	12M
Pine	109M
Fog	111M

Shell Upholstery

FULLY UPHOLSTERED SHELL

Please refer to Leland Textile Program which features textiles and leathers from the following partners:

- Camira
- Green Hides
- Carnegie
- Maharam
- CF Stinson
- Unika Vaev

The complete grade list can be found at www.lelandfurniture.com/ecatalog or you can specify COM/COL. Due to the design of this product, it is recommended that all non pre-approved textile be tested for compatibility.

Upholstered Onlay selection

Please refer to Leland Textile Program which features textiles and leathers from the following partners:

- Camira
- Green Hides
- Carnegie
- Maharam
- CF Stinson
- Unika Vaev

The complete grade list can be found at lelandinternational.com/ecatalog or you can specify COM/COL. Due to the design of this product, it is recommended that all non pre-approved textile be tested for compatibility.

Specifications required to create the product code

- Shell Selection
- Shell Finish
- Upholstered Onlay Selection (When Applicable)

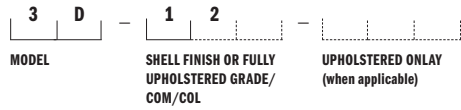

SHELL SELECTION

3D Veneer Shell (3D)

SHELL FINISH

Natural White Oak (12)

UPHOLSTERED ONLAY SELECTION

When applicable, enter upholstery grade, COM or COL

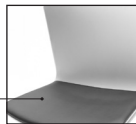

SLAM BEAM SHELL SELECTION
 Design: Lievore Altherr Molina, licensed by Sellex

SB15



Polypropylene	MODEL	LIST PRICE
	PO	\$201



Polypropylene W/ Upholstered Seat Only	MODEL	COM/COL	A	B	C	D	E	F	G	H	I	J	K	L
	PU	\$332	405	440	477	513	548	586	622	657	695	731	766	803

COM Yardage: 1 or 2 seats: .75 yard
 Contact Leland Customer Experience for yardage requirements on textiles with repeats.
 For COL requirements please contact Leland Customer Experience.



Fully Upholstered	MODEL	COM/COL	A	B	C	D	E	F	G	H	I	J	K	L
	FU	\$472	546	585	623	661	699	736	775	814	850	889	926	965

COM Yardage: 1 or 2 seats: .75 yard
 Contact Leland Customer Experience for yardage requirements on textiles with repeats.
 For COL requirements please contact Leland Customer Experience.

To specify:
 Refer to pages SB11-SB12

SLAM BEAM SHELL SELECTION
 Design: Lievore Altherr Molina, licensed by Sellex

SB16



3D Beech Veneer	MODEL	LIST PRICE
	3DB	\$673



3D Beech Veneer W/ Upholstered Seat Only	MODEL	COM/COL	A	B	C	D	E	F	G	H	I	J	K	L
	3BU	\$807	879	914	952	988	1023	1060	1096	1131	1169	1205	1240	1278

COM Yardage: 1 or 2 seats: .75 yard
 Contact Leland Customer Experience for yardage requirements on textiles with repeats.
 For COL requirements please contact Leland Customer Experience.



3D Oak Veneer	MODEL	LIST PRICE
	3DO	\$849



3D Oak Veneer W/ Upholstered Seat Only	MODEL	COM/COL	A	B	C	D	E	F	G	H	I	J	K	L
	30U	\$982	1054	1090	1126	1162	1198	1234	1270	1307	1344	1380	1416	1452

COM Yardage: 1 or 2 seats: .75 yard
 Contact Leland Customer Experience for yardage requirements on textiles with repeats.
 For COL requirements please contact Leland Customer Experience.

To specify:
 Refer to pages SB11-SB12

Table Model

DESCRIPTION	CODE
Slam table	SBT

Top Finish or Color

LAMINATE TOP:

DESCRIPTION	CODE
Black (Pionite® Suede Black)	LBK
White (WilsonArt® Designer White) LWH Custom	CST

Edge Finish

DESCRIPTION	CODE
Opaque Black	B
Opaque White	W
Natural	11

Specifications required to create the product code

- Table Model
- Top Finish
- Edge Finish



TABLE MODEL

Slam Beam Table (SBT)

TOP FINISH

White Laminate (W)

EDGE FINISH

Opaque White (W)

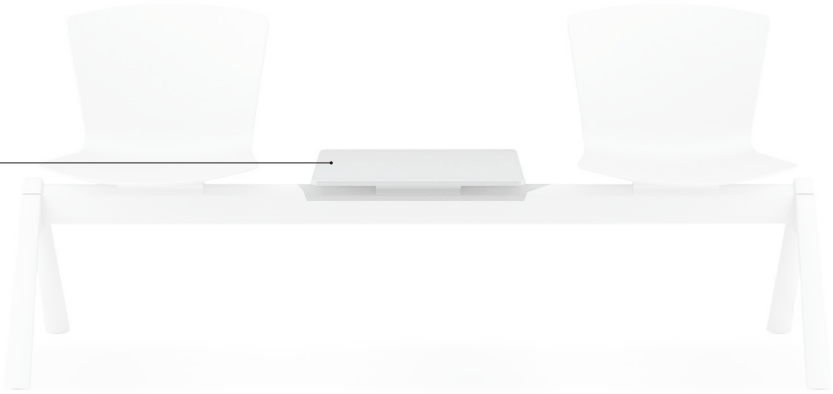

Slam Beam Table	MODEL	FRAME FINISH	LIST PRICE
one base position	SBT	Laminate	\$327

W 22 D 22
TH 17.75 (MOUNTED TO BASE)

Please note that Opaque White and Opaque Black Edge Finishes will have an additional \$20 NET charge.



To specify:
Refer to pages SB14-SB15

Slam Beam Floor Mount	MODEL	LIST PRICE
	SBFM	\$213

Floor mount must be specified at the time of order.
Due to the variety of floor surfaces on which Slam Beam may be installed, floor mount fasteners are not supplied by Leland.
Responsibility of fastener choice is the customers.

To specify:
Refer to pages SB14-SB15

**5695 Eagle Drive, SE
Grand Rapids,
Michigan 49512
616-975-9260
lelandfurniture.com**

Valeri Seating

January 2024 Price List



Valeri

Table of Contents	VS2
Specification Information	VS3
Specification Example	VS4
Guest Chair, Lounge Chair, Settee	VS5

Chair Model

DESCRIPTION	CODE
Valeri guest chair	VG
Valeri lounge chair	VL
Valeri settee	VS

Frame Finish

DESCRIPTION	CODE
Brushed stainless steel	SS

Upholstery Selection

Please refer to Leland Textile Program which features textiles and leathers from the following partners:

- Camira
- Carnegie
- CF Stinson
- Green Hides
- Maharam
- Unika Vaev

The complete grade list can be found at lelandinternational.com/ecatalog or you can specify COM/COL. Due to the design of this product, it is recommended that all non pre-approved textile be tested for compatibility.

Glides

Valeri glides are steel swivel with nylon bottom.

Freight Note

Due to the size and nature of Valeri Seating, the Freight Program does not apply to this product. Please contact Customer Experience for a quote.

Specifications required to create the product code

- Model
- Frame Finish
- Upholstery Selection



MODEL

Valeri Lounge Chair (VL)

FRAME FINISH

Brushed Stainless Steel (SS)

UPHOLSTERY SELECTION

Enter upholstery grade, COM or COL. Grade J (J)





Valeri Guest Chair

W 21.5 D 23 H 29
SH 18 AH 24.5

MODEL	LIST PRICE/ GRADE	COM/COL	A	B	C	D	E	F	G	H	I	J	K	L
VG		\$1663	1778	1838	1897	1955	2015	2074	2134	2192	2250	2310	2369	2427

COM Yardage: 1 or 2 chairs: 1.75 yards
Contact Leland Customer Experience for yardage requirements on textiles with repeats.
For COL requirements please contact Leland Customer Experience.

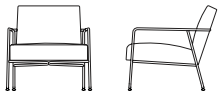

Valeri Lounge Chair

W 27.5 D 29.5 H 27
SH 15 AH 21

MODEL	LIST PRICE/ GRADE	COM/COL	A	B	C	D	E	F	G	H	I	J	K	L
VL		\$2359	2526	2611	2695	2777	2861	2946	3030	3113	3198	3281	3367	3449

COM Yardage: 1 chair: 2.5 yards; 2 chairs: 3 yards; 3 or 4 chairs: 6 yards; 5 chairs: 6.5 yards
Contact Leland Customer Experience for yardage requirements on textiles with repeats.
For COL requirements please contact Leland Customer Experience.

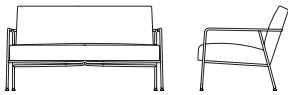

Valeri Settee

W 50 D 29.5 H 27
SH 15 AH 21

MODEL	LIST PRICE/ GRADE	COM/COL	A	B	C	D	E	F	G	H	I	J	K	L
VS		\$3690	4025	4193	4360	4527	4695	4864	5032	5199	5367	5536	5704	5869

COM Yardage: 1 settee: 3 yards
Due to upholstery requirements, Valeri Settee textile can only be upholstered railroaded.
Please consider when specifying upholstery with a pattern or repeat.
Contact Leland Customer Experience for yardage requirements on textiles with repeats.
For COL requirements please contact Leland Customer Experience.

To specify:
Please refer to pages 3-4 for complete specifying information.
Specify all products by their product code.

5695 Eagle Drive, SE
Grand Rapids,
Michigan 49512
616-975-9260
lelandfurniture.com

Mass

January 2024 Price List



Mass

Table of Contents	MA2
Specification Information	MA3
Specification Example	MA4
Stacking Side Chair	MA5
Stacking Side Chair, Upholstered Seat	MA6
Stacking Arm Chair	MA7
Stacking Arm Chair, Upholstered Seat	MA8
Stacking Counter Chair	MA9
Stacking Counter Chair, Upholstered Seat	MA10
Stacking Bar Chair	MA11
Stacking Bar Chair, Upholstered Seat	MA12
Transport/Stacking Dolly	MA13
Ganging Device	MA13

Chair Model

DESCRIPTION	CODE
Mass stacking side chair	MASS
Mass stacking side chair, upholstered seat	MASSU
Mass stacking arm chair	MASA
Mass stacking arm chair, upholstered seat	MASAU
Mass stacking counter chair	MASC
Mass stacking counter chair, upholstered seat	MASCU
Mass stacking bar chair	MASB
Mass stacking bar chair, upholstered seat	MASBU
Mass transport/stacking dolly	MASD

Seat/Back Color

POLYPROPYLENE SHELL:

DESCRIPTION	CODE
White	WT
Black	BK
Dolphin	DL
Pistachio	PS

CUSTOM POLYPROPYLENE COLORS

Custom color match is available upon request. Please contact hello@lelandfurniture.com for further information

Onlay Selection

Please refer to Leland Textile Program which features textiles and leathers from the following partners:

- [Pre-approved Textiles](#)

The complete grade list can be found at www.lelandfurniture.com/resources or you can specify COM/COL. Due to the design of this product, it is recommended that all non pre-approved textile be tested for compatibility.

Frame Finish

DESCRIPTION	CODE
Chrome	C
Matte Pistachio	MPS
Sterling	ST
Dolphin Textured	DLT
White Textured	WT
Black Textured	BT

Glide Type

STANDARD:

DESCRIPTION	CODE
Nylon	S

OPTIONAL:

DESCRIPTION	CODE
Felt	F

Stacking Note

Mass side chair, arm chair and bar chair models stack as follows (includes upholstered):

SIDE CHAIR:

Floor: 15 High
Dolly: 40 High

ARM CHAIR:

Floor: 12 High
Dolly: 40 High

BAR & COUNTER CHAIR:

Floor: 8 High

Chair Weight

SIDE CHAIR: 12 lbs

ARM CHAIR: 14 lbs

Specifications required to create the product code

- Model
- Shell Finish
- Upholstered Onlay Selection (when applicable)
- Frame Finish
- Glide or Caster Type

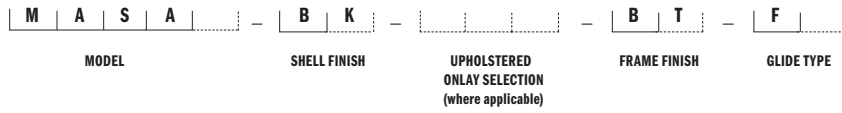

MODEL

Mass stacking arm chair (MASA)

SHELL FINISH

Black (BK)

UPHOLSTERED ONLAY SELECTION

When applicable, enter upholstery grade, COM

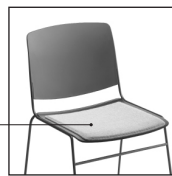

FRAME FINISH

Black Textured (BT)

GLIDE TYPE

Optional Felt (F)



MASS STACKING SIDE CHAIR
 Design: ITEMdesignworks, licensed by Sellex

MA5



PRICING FOR QUANTITIES 1-99

Mass Stacking Side Chair	MODEL	FRAME FINISH	LIST PRICE
Polypropylene shell	MASS	Powder Coat	\$375
W 20.5 D 20.5 H 32.25 SH 18		Chrome	\$440

Optional Glides: Add \$8.00 net per chair for a set of four (4).



PRICING FOR QUANTITIES 100-299

Mass Stacking Side Chair	MODEL	FRAME FINISH	LIST PRICE
Polypropylene shell	MASS	Powder Coat	\$359
W 20.5 D 20.5 H 32.25 SH 18		Chrome	\$416

Optional Glides: Add \$8.00 net per chair for a set of four (4).



PRICING FOR QUANTITIES 300+

Mass Stacking Side Chair	MODEL	FRAME FINISH	LIST PRICE
Polypropylene shell	MASS	Powder Coat	\$336
W 20.5 D 20.5 H 32.25 SH 18		Chrome	\$393

Optional Glides: Add \$8.00 net per chair for a set of four (4).

To specify:
 Please refer to pages 3-4 for complete specifying information.
 Specify all products by their product code.

Pricing Effective: January 2024

MASS STACKING SIDE CHAIR, UPHOLSTERED SEAT
 Design: ITEMdesignworks, licensed by Sellex

MA6



PRICING FOR QUANTITIES 1-99

Mass Stacking Side Chair

	MODEL	LIST PRICE/GRADE	COM/COL	A	B	C	D	E	F	G	H	I	J	K	L
Polypropylene shell, upholstered seat onlay	MASSU	Powder Coat	\$518	554	589	626	662	697	733	769	804	840	875	911	947
		Chrome	\$582	618	654	690	726	761	798	834	869	905	940	976	1012

W 20.5 D 20.5 H 32.25 SH 18

COM Yardage: 1-3 seats: .5 yard
 Contact Leland Customer Experience for yardage requirements on textiles with repeats.
 For COL requirements please contact Leland Customer Experience.
 Optional Glides: Add \$8.00 net per chair for a set of four (4).



PRICING FOR QUANTITIES 100-299

Mass Stacking Side Chair

	MODEL	LIST PRICE/GRADE	COM/COL	A	B	C	D	E	F	G	H	I	J	K	L
Polypropylene shell, upholstered seat onlay	MASSU	Powder Coat	\$488	524	560	596	631	667	702	738	774	809	845	882	917
		Chrome	\$548	585	621	656	692	729	764	800	836	871	907	943	978

W 20.5 D 20.5 H 32.25 SH 18

COM Yardage: 1-3 seats: .5 yard
 Contact Leland Customer Experience for yardage requirements on textiles with repeats.
 For COL requirements please contact Leland Customer Experience.
 Optional Glides: Add \$8.00 net per chair for a set of four (4).



PRICING FOR QUANTITIES 300+

Mass Stacking Side Chair

	MODEL	LIST PRICE/GRADE	COM/COL	A	B	C	D	E	F	G	H	I	J	K	L
Polypropylene shell, upholstered seat onlay	MASSU	Powder Coat	\$461	497	533	568	604	640	675	712	748	783	819	855	890
		Chrome	\$519	555	590	627	663	698	734	770	805	841	877	912	948

W 20.5 D 20.5 H 32.25 SH 18

COM Yardage: 1-3 seats: .5 yard
 Contact Leland Customer Experience for yardage requirements on textiles with repeats.
 For COL requirements please contact Leland Customer Experience.
 Optional Glides: Add \$8.00 net per chair for a set of four (4).

To specify:
 Please refer to pages 3-4 for complete specifying information.
 Specify all products by their product code.

Pricing Effective: January 2024

MASS STACKING ARM CHAIR
 Design: ITEMdesignworks, licensed by Sellex

MA7



PRICING FOR QUANTITIES 1-99

Mass Stacking Arm Chair	MODEL	FRAME FINISH	LIST PRICE
Polypropylene shell	MASA	Powder Coat	\$520
W 20.5 D 20.5 H 32.25 SH 18		Chrome	\$583

Optional Glides: Add \$8.00 net per chair for a set of four (4).



PRICING FOR QUANTITIES 100-299

Mass Stacking Arm Chair	MODEL	FRAME FINISH	LIST PRICE
Polypropylene shell	MASA	Powder Coat	\$488
W 20.5 D 20.5 H 32.25 SH 18		Chrome	\$554

Optional Glides: Add \$8.00 net per chair for a set of four (4).



PRICING FOR QUANTITIES 300+

Mass Stacking Arm Chair	MODEL	FRAME FINISH	LIST PRICE
Polypropylene shell	MASA	Powder Coat	\$462
W 20.5 D 20.5 H 32.25 SH 18		Chrome	\$519

Optional Glides: Add \$8.00 net per chair for a set of four (4).

To specify:
 Please refer to pages 3-4 for complete specifying information.
 Specify all products by their product code.

Pricing Effective: January 2024

MASS STACKING ARM CHAIR, UPHOLSTERED SEAT
 Design: ITEMdesignworks, licensed by Sellex

MA8



PRICING FOR QUANTITIES 1-99

Mass Stacking Arm Chair

	MODEL	LIST PRICE/GRADE	COM/COL	A	B	C	D	E	F	G	H	I	J	K	L
Polypropylene shell, upholstered seat onlay	MASAU	Powder Coat	\$606	643	678	714	750	785	821	857	892	929	965	1000	1037
		Chrome	\$673	709	745	781	817	852	888	924	959	995	1032	1067	1103

W 20.5 D 20.5 H 32.25 SH 18

COM Yardage: 1-3 seats: .5 yard
 Contact Leland Customer Experience for yardage requirements on textiles with repeats.
 For COL requirements please contact Leland Customer Experience.
 Optional Glides: Add \$8.00 net per chair for a set of four (4).



PRICING FOR QUANTITIES 100-299

Mass Stacking Arm Chair

	MODEL	LIST PRICE/GRADE	COM/COL	A	B	C	D	E	F	G	H	I	J	K	L
Polypropylene shell, upholstered seat onlay	MASAU	Powder Coat	\$572	609	645	680	716	752	787	823	860	895	931	967	1003
		Chrome	\$636	672	708	743	780	816	851	887	923	958	994	1030	1066

W 20.5 D 20.5 H 32.25 SH 18

COM Yardage: 1-3 seats: .5 yard
 Contact Leland Customer Experience for yardage requirements on textiles with repeats.
 For COL requirements please contact Leland Customer Experience.
 Optional Glides: Add \$8.00 net per chair for a set of four (4).



PRICING FOR QUANTITIES 300+

Mass Stacking Arm Chair

	MODEL	LIST PRICE/GRADE	COM/COL	A	B	C	D	E	F	G	H	I	J	K	L
Polypropylene shell, upholstered seat onlay	MASAU	Powder Coat	\$541	577	612	648	684	719	755	792	827	863	900	935	971
		Chrome	\$600	635	671	707	742	778	815	850	886	922	957	993	1029

W 20.5 D 20.5 H 32.25 SH 18

COM Yardage: 1-3 seats: .5 yard
 Contact Leland Customer Experience for yardage requirements on textiles with repeats.
 For COL requirements please contact Leland Customer Experience.
 Optional Glides: Add \$8.00 net per chair for a set of four (4).

To specify:
 Please refer to pages 3-4 for complete specifying information.
 Specify all products by their product code.

Pricing Effective: January 2024

MASS STACKING COUNTER CHAIR
 Design: ITEMdesignworks, licensed by Sellex

MA9



PRICING FOR QUANTITIES 1-99

Mass Stacking Counter Chair	MODEL	FRAME FINISH	LIST PRICE
Polypropylene shell	MASC	Powder Coat	\$671
W 21.75 D 20.5 H 40.75 SH 25		Chrome	\$736

Optional Glides: Add \$8.00 net per chair for a set of four (4).



PRICING FOR QUANTITIES 100-299

Mass Stacking Counter Chair	MODEL	FRAME FINISH	LIST PRICE
Polypropylene shell	MASC	Powder Coat	\$634
W 21.75 D 20.5 H 40.75 SH 25		Chrome	\$696

Optional Glides: Add \$8.00 net per chair for a set of four (4).



PRICING FOR QUANTITIES 300+

Mass Stacking Counter Chair	MODEL	FRAME FINISH	LIST PRICE
Polypropylene shell	MASC	Powder Coat	\$598
W 21.75 D 20.5 H 40.75 SH 25		Chrome	\$635

Optional Glides: Add \$8.00 net per chair for a set of four (4).

To specify:
 Please refer to pages 3-4 for complete specifying information.
 Specify all products by their product code.

Pricing Effective: January 2024

MASS STACKING COUNTER CHAIR, UPHOLSTERED SEAT
 Design: ITEMdesignworks, licensed by Sellex

MA10



PRICING FOR QUANTITIES 1-99

Mass Stacking Counter Chair

MODEL	LIST PRICE/GRADE	COM/COL	A	B	C	D	E	F	G	H	I	J	K	L
Polypropylene shell, upholstered seat onlay	Powder Coat	\$805	841	875	910	945	979	1014	1048	1083	1118	1152	1187	1221
	Chrome	\$871	906	940	975	1010	1044	1079	1113	1148	1183	1217	1252	1288

W 21.75 D 20.5 H 40.75 SH 25

COM Yardage: 1-3 seats: .5 yard
 Contact Leland Customer Experience for yardage requirements on textiles with repeats.
 For COL requirements please contact Leland Customer Experience.
 Optional Glides: Add \$8.00 net per chair for a set of four (4).



PRICING FOR QUANTITIES 100-299

Mass Stacking Counter Chair

MODEL	LIST PRICE/GRADE	COM/COL	A	B	C	D	E	F	G	H	I	J	K	L
Polypropylene shell, upholstered seat onlay	Powder Coat	\$760	795	829	864	900	934	969	1003	1038	1073	1107	1142	1177
	Chrome	\$823	858	892	927	961	997	1032	1066	1102	1137	1171	1206	1240

W 21.75 D 20.5 H 40.75 SH 25

COM Yardage: 1-3 seats: .5 yard
 Contact Leland Customer Experience for yardage requirements on textiles with repeats.
 For COL requirements please contact Leland Customer Experience.
 Optional Glides: Add \$8.00 net per chair for a set of four (4).



PRICING FOR QUANTITIES 300+

Mass Stacking Counter Chair

MODEL	LIST PRICE/GRADE	COM/COL	A	B	C	D	E	F	G	H	I	J	K	L
Polypropylene shell, upholstered seat onlay	Powder Coat	\$716	751	785	820	855	889	924	958	993	1028	1063	1098	1132
	Chrome	\$774	808	843	878	913	948	982	1017	1052	1087	1122	1156	1191

W 21.75 D 20.5 H 40.75 SH 25

COM Yardage: 1-3 seats: .5 yard
 Contact Leland Customer Experience for yardage requirements on textiles with repeats.
 For COL requirements please contact Leland Customer Experience.
 Optional Glides: Add \$8.00 net per chair for a set of four (4).

To specify:
 Please refer to pages 3-4 for complete specifying information.
 Specify all products by their product code.

Pricing Effective: January 2024

MASS STACKING BAR CHAIR
 Design: ITEMdesignworks, licensed by Sellex

MA11



PRICING FOR QUANTITIES 1-99

Mass Stacking Bar Chair	MODEL	FRAME FINISH	LIST PRICE
Polypropylene shell	MASB	Powder Coat	\$692
W 21.75 D 20.5 H 40.75 SH 29		Chrome	\$759

Optional Glides: Add \$8.00 net per chair for a set of four (4).



PRICING FOR QUANTITIES 100-299

Mass Stacking Bar Chair	MODEL	FRAME FINISH	LIST PRICE
Polypropylene shell	MASB	Powder Coat	\$654
W 21.75 D 20.5 H 40.75 SH 29		Chrome	\$717

Optional Glides: Add \$8.00 net per chair for a set of four (4).



PRICING FOR QUANTITIES 300+

Mass Stacking Bar Chair	MODEL	FRAME FINISH	LIST PRICE
Polypropylene shell	MASB	Powder Coat	\$615
W 21.75 D 20.5 H 40.75 SH 29		Chrome	\$655

Optional Glides: Add \$8.00 net per chair for a set of four (4).

To specify:
 Please refer to pages 3-4 for complete specifying information.
 Specify all products by their product code.

Pricing Effective: January 2024

MASS STACKING BAR CHAIR, UPHOLSTERED SEAT
 Design: ITEMdesignworks, licensed by Sellex

MA12



PRICING FOR QUANTITIES 1-99

Mass Stacking Bar Chair

Polypropylene shell,
upholstered seat onlay

W 21.75 D 20.5 H 40.75 SH 29

MODEL	LIST PRICE/GRADE	COM/COL	A	B	C	D	E	F	G	H	I	J	K	L
MASBU	Powder Coat	\$831	867	903	938	974	1010	1045	1081	1117	1152	1188	1225	1260
	Chrome	\$897	934	970	1005	1041	1077	1112	1148	1184	1219	1255	1291	1327

COM Yardage: 1-3 seats: .5 yard
 Contact Leland Customer Experience for yardage requirements on textiles with repeats.
 For COL requirements please contact Leland Customer Experience.
 Optional Glides: Add \$8.00 net per chair for a set of four (4).



PRICING FOR QUANTITIES 100-299

Mass Stacking Bar Chair

Polypropylene shell,
upholstered seat onlay

W 21.75 D 20.5 H 40.75 SH 29

MODEL	LIST PRICE/GRADE	COM/COL	A	B	C	D	E	F	G	H	I	J	K	L
MASBU	Powder Coat	\$783	819	855	890	926	961	998	1034	1070	1106	1142	1177	1213
	Chrome	\$849	885	921	956	992	1028	1063	1100	1135	1171	1208	1243	1279

COM Yardage: 1-3 seats: .5 yard
 Contact Leland Customer Experience for yardage requirements on textiles with repeats.
 For COL requirements please contact Leland Customer Experience.
 Optional Glides: Add \$8.00 net per chair for a set of four (4).



PRICING FOR QUANTITIES 300+

Mass Stacking Bar Chair

Polypropylene shell,
upholstered seat onlay

W 21.75 D 20.5 H 40.75 SH 29

MODEL	LIST PRICE/GRADE	COM/COL	A	B	C	D	E	F	G	H	I	J	K	L
MASBU	Powder Coat	\$738	774	809	845	882	917	953	989	1024	1060	1096	1131	1167
	Chrome	\$799	835	870	906	942	977	1013	1048	1084	1120	1156	1192	1228

COM Yardage: 1-3 seats: .5 yard
 Contact Leland Customer Experience for yardage requirements on textiles with repeats.
 For COL requirements please contact Leland Customer Experience.
 Optional Glides: Add \$8.00 net per chair for a set of four (4).

To specify:
 Please refer to pages 3-4 for complete specifying information.
 Specify all products by their product code.

Pricing Effective: January 2024

MASS TRANSPORT/STACKING DOLLY
 Design: ITEMdesignworks, licensed by Sellex

MA13

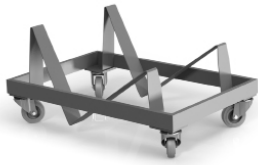

Mass Transport/Stacking Dolly	MODEL	FRAME FINISH	LIST PRICE
Black powder coat finish	MASD		\$1107
W 34.5 D 23 H 17 (Dimensions of dolly when empty)		Mass Transport/Stacking Dolly capacity: 40 high (15 high on floor) Weight with 40 high on dolly: 565 lbs For use with Side and Arm Chair models (including upholstered)	
W 41.25 D 23 H 65.25 (Dimensions with 40 poly chair stack)		**Bar and Counter models do not stack on dolly	

MASS AUXILIARY OPTIONS
 Design: ITEMdesignworks, licensed by Sellex



Ganging Device	MODEL	LIST PRICE
two per set	GD	\$55

Available for all models **Only comes in black

To specify:
 Please refer to pages 3-4 for complete specifying information.
 Specify all products by their product code.

Pricing Effective: January 2024

5695 Eagle Drive, SE
Grand Rapids,
Michigan 49512
616-975-9260
lelandfurniture.com

Geode

June 2024 Price List



Geode

Table of Contents	GD2
Specification Information	GD3
Specification Example	GD4
Geode Lounge	GD5

Chair Model

DESCRIPTION	CODE
Geode Lounge	GDL

Upholstery Selection

Please refer to Leland Textile Program which features textiles and leathers from the following partners:

- [Pre-approved Textiles](#)

The complete grade list can be found at Leland’s website or you can specify COM/COL. Due to the design of this product, it is recommended that all non pre-approved textile be tested for compatibility.

Due to upholstery requirements, the Geode can only be upholstered railroaded. Please consider when specifying textiles with a pattern

Auxiliary

DESCRIPTION	CODE
Pepper Power Right Hand Side	PWRR
Pepper Power Left Hand Side	PWRL
Salt USB Right Hand Side	USBR
Salt USB Left Hand Side	USBL

AUXILIARY COLOR OPTIONS:

Black	B
Storm	ST
White	W

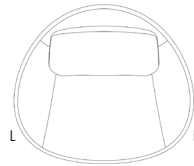

Product Weight

DESCRIPTION	LBS
Geode Lounge	90

Specifications required to create the product code

- Model
- Upholstery Selection
- Auxiliary



MODEL

Geode (GDL)

UPHOLSTERY SELECTION

Enter upholstery grade or COM



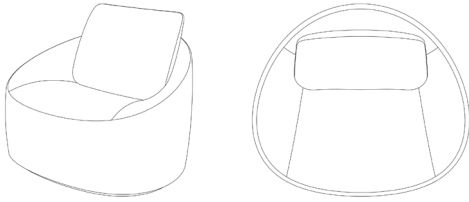

Geode Lounge			MODEL	LIST PRICE/ GRADE	COM/COL	A	B	C	D	E	F	G	H	I	J	K	L
W 38.39	D 34.06	H 30	GDL		\$2930	3170	3291	3412	3533	3654	3775	3896	4017	4138	4259	4380	4501

SH 18

COM Yardage: 4 Yards

Contact Leland Customer Experience for yardage requirements on textiles with repeats.
For COL requirements please contact Leland Customer Experience.

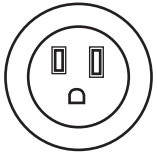

Pepper-Power Receptacle	MODEL		LIST PRICE
Black (B), Storm (ST), White (W)	PWRR	Pepper Power Right Hand Side	\$243
Dia 2"	PWRL	Pepper Power Left Hand Side	\$243



Salt-Dual USB Charger	MODEL		LIST PRICE
Black (B), Storm (ST), White (W)	USBR	Salt USB Right Hand Side	\$355
Dia 2"	USBL	Salt USB Left Hand Side	\$355

To specify:
Please refer to pages 3-4 for complete specifying information.
Specify all products by their product code.

**5695 Eagle Drive, SE
Grand Rapids,
Michigan 49512
616-975-9260
lelandfurniture.com**

Bimini

January 2024 Price List



Bimini

Table of Contents	BI-2
Specification Information	BI-3
Specification Example	BI-4
Bimini Order Diagram	BI-5
Bimini High Panel	BI-6
Bimini Low Panel	BI-7
Bimini Accessory	BI-8
Bimini Auxiliary	BI-9

Bimini Model

DESCRIPTION	CODE
Bimini High Panel Desk Height	BIHD
Bimini High Panel Counter Height	BIHC
Bimini High Panel Free Standing	BIHF
Bimini Low Panel Desk Height	BILD
Bimini Low Panel Counter Height	BILC
Bimini Low Panel Free Standing	BILF

Panel Finish

DESCRIPTION	CODE
Abalone	PET01
Shamrock	PET06
Burnt Clay	PET07
Merlot	PET08
Royal	PET09
Turmeric	PET11
Laurel	PET12
Charcoal	PET13

Top Type

DESCRIPTION	CODE
Oak	O
Walnut	W
Laminate	L

Top Finish Options

OAK FINISH OPTIONS

DESCRIPTION	CODE
Natural White Oak	12M
Morel	66M

WALNUT FINISH OPTIONS

DESCRIPTION	CODE
Natural Walnut	08M

LAMINATE FINISH OPTIONS

DESCRIPTION	CODE
Platinum Wilsonart® (D315-60)	LGP
Black Pionite® (SE101)	LBK
White Wilsonart® (D354-60)	LWH

Rail Finish

DESCRIPTION	CODE
Black Textured	BT

Table Accessory Position 1-5 Option

DESCRIPTION	CODE
Salt USB	USB
Pepper Power	PWR
Pippa Light	PPL
Monitor Mount & Grommet (Left side)	GML
Monitor Mount & Grommet (Right side) (White or Black)	GMR

Auxiliary Options

DESCRIPTION	CODE
Coat Hook	CHK
Bag Hook	BHK
Customizable Signage	CSG
Linking Set 2 Panels	2LS
Linking Set 3 Panels	3LS

Table Edge Type

DESCRIPTION	CODE
1" flat plywood	W2



Specifications required to create the product code

- Model
- Panel Finish
- Top Type
- Top Finish
- Rail Finish
- Table Accessory Option
- Auxiliary Option

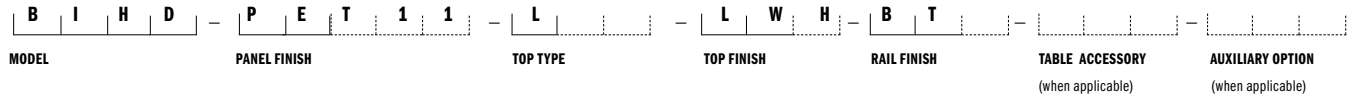

MODEL

Bimini High Panel Desk Height (BIHD)

PANEL FINISH

Royal (PET11)

TOP TYPE

Laminate (L)

TOP FINISH

Designer White D354-60 (LWH)
(when applicable)

RAIL FINISH

Black Textured (BT)



1. Accessorize your Bimini

Please complete and include with your order. If multiple units are ordered, a diagram must be completed for each unique unit.

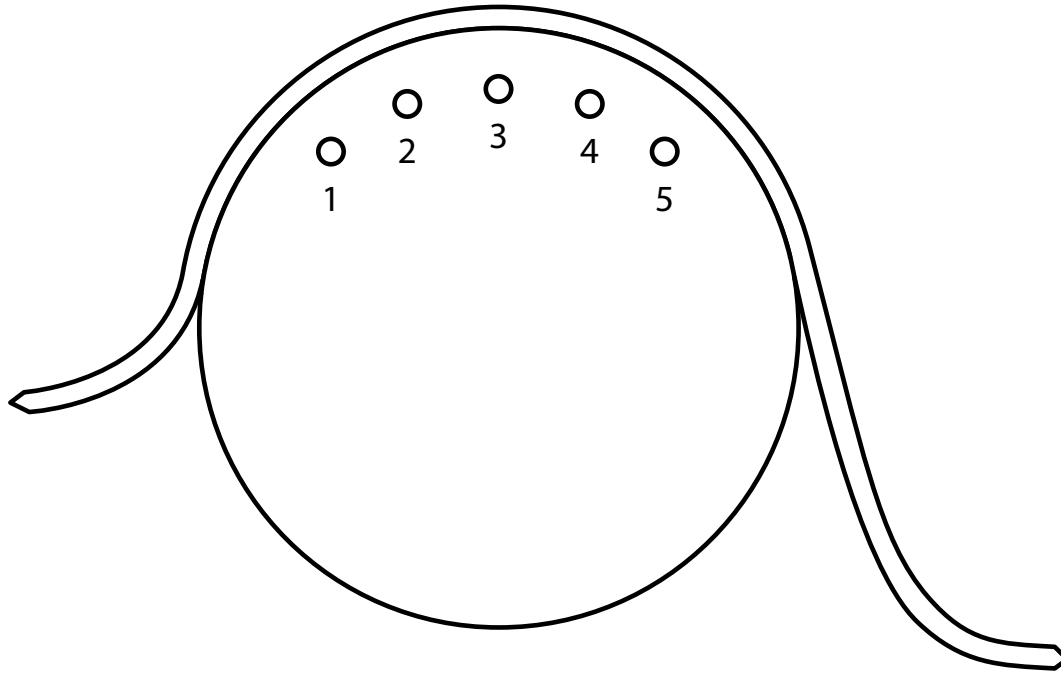

2. Check the box that fits your need

Salt (any position on table), Pepper (any position on table), Pippa (any position if no Monitor Mount). Monitor (any position on table with grommet in position next to mount) Monitors (less than 24") and Pippa (mount in 1 or 2 and Pippa in 5/Pippa in 1 and mount in 4 or 5), Monitors (24"-32") and Pippa (mount in 1 and Pippa in 5/Pippa in 1 and mount in 5).

POSITION ONE	POSITION TWO	POSITION THREE	POSITION FOUR	POSITION FIVE
<input type="checkbox"/> No Accessory Accessory <input type="checkbox"/> Salt USB <input type="checkbox"/> Pepper Power <input type="checkbox"/> Pippa Light <input type="checkbox"/> Monitor Mount & Grommet (Right Side)	<input type="checkbox"/> No Accessory Accessory <input type="checkbox"/> Salt USB <input type="checkbox"/> Pepper Power <input type="checkbox"/> Pippa Light <input type="checkbox"/> Monitor Mount & Grommet (Right Side) <input type="checkbox"/> Monitor Mount & Grommet (Left Side)	<input type="checkbox"/> No Accessory Accessory <input type="checkbox"/> Salt USB <input type="checkbox"/> Pepper Power <input type="checkbox"/> Pippa Light <input type="checkbox"/> Monitor Mount & Grommet (Right Side) <input type="checkbox"/> Monitor Mount & Grommet (Left Side)	<input type="checkbox"/> No Accessory Accessory <input type="checkbox"/> Salt USB <input type="checkbox"/> Pepper Power <input type="checkbox"/> Pippa Light <input type="checkbox"/> Monitor Mount & Grommet (Right Side) <input type="checkbox"/> Monitor Mount & Grommet (Left Side)	<input type="checkbox"/> No Accessory Accessory <input type="checkbox"/> Salt USB <input type="checkbox"/> Pepper Power <input type="checkbox"/> Pippa Light <input type="checkbox"/> Monitor Mount & Grommet (Left Side)

BIMINI, HIGH PANEL
 Design: Altherr Désile Park

BI-6

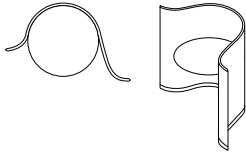

Bimini

High Panel, Desk Height

	MODEL	BASE	LAMINATE TOP	WALNUT TOP	OAK TOP
56" Panel, 29" Height Table	BIHD	Powder Coat	\$5790	\$5975	\$5975

W69, D43.5, H56, TH29

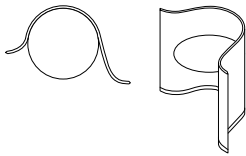

Bimini

High Panel, Counter Height

	MODEL	BASE	LAMINATE TOP	WALNUT TOP	OAK TOP
56" Panel, 36" Height Table	BIHC	Powder Coat	\$5990	\$6175	\$6175

W69, D43.5, H56, TH36

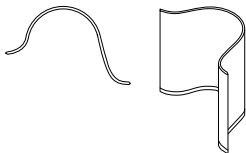

Bimini

High Panel Free Standing

	MODEL	BASE	LIST PRICE
56" Panel	BIHF	Powder Coat	\$4975

W69, D43.5, H56

To specify:
 Please refer to pages 3-4 for complete specifying information.
 Specify all products by their product code.

Pricing Effective: January 2024

BIMINI, LOW PANEL
 Design: Altherr Désile Park

BI-7

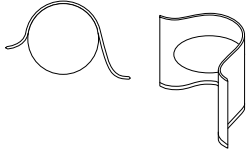

Bimini

Low Panel, Desk Height

	MODEL	BASE	LAMINATE TOP	WALNUT TOP	OAK TOP
48" Panel, 29" Height Table	BILD	Powder Coat	\$5640	\$5825	\$5825

W69, D43.5, H48, TH29

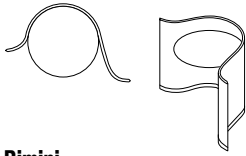

Bimini

Low Panel, Counter Height

	MODEL	BASE	LAMINATE TOP	WALNUT TOP	OAK TOP
48" Panel, 36" Height Table	BILC	Powder Coat	\$5840	\$6025	\$6025

W69, D43.5, H48, TH36

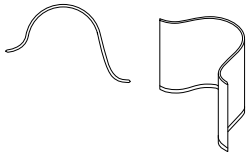

Bimini

Low Panel Free Standing

	MODEL	BASE	LIST PRICE
48" Panel	BILF	Powder Coat	\$4775

W69, D43.5, H48

To specify:
 Please refer to pages 3-4 for complete specifying information.
 Specify all products by their product code.

Pricing Effective: January 2024

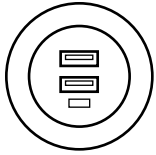

Salt-Dual USB charger	MODEL		LIST PRICE
White, Black	USB	Starter Unit (Includes one Salt and four port power box)	\$655
Dia 2" H 0.125"		Add on Unit (includes one salt only)	\$255

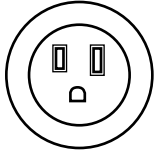

Pepper-Power Receptacle	MODEL		LIST PRICE
White, Black	PWR	Starter Unit (Includes one Pepper and four port power box)	\$543
Dia 2" H 0.125"		Add on Unit (includes one pepper only)	\$143

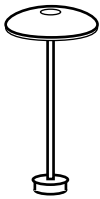

Pippa Light	MODEL		LIST PRICE
White, Black	PPL	Starter Unit (Includes one Pippa light and four port power box)	\$875
Dia 6.29" H 16.125"		Add on Unit (includes one Pippa light only)	\$475

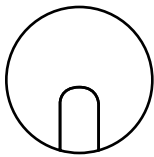
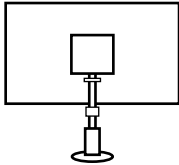

Monitor Mount & Grommet	MODEL		LIST PRICE
White, Black	MMT	Starter Unit (Includes one Monitor Mount with Grommet and four port power box)	\$855
		Add on Unit (includes one Monitor Mount with Grommet only)	\$455

*One Starter Unit required per Bimini
 *Power box has 12' cord length

To specify:
 Please complete diagram on page 5
 Specify all products by their
 product code.



Customizable Signage	MODEL	LIST PRICE
Alphanumeric Character	CSG	\$459
Dia 6" Decal 4"		

Bag Hook	MODEL	LIST PRICE
Under Table Top	BHK	\$168



Coat Hook	MODEL	LIST PRICE
Oak Or Walnut	CHK	\$245
Dia 3.15"		
Coat Hook Located on inside of Panel, 4" from top and 10" from Right hand side		

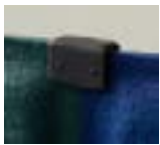

Link Set	MODEL	LIST PRICE
Link 2 Bimini	2LS	\$235



120 Link Set	MODEL	LIST PRICE
Link 3 Bimini	3LS	\$265

To specify:
 Please refer to pages 3-4 for complete specifying information.
 Specify all products by their product code.

**5695 Eagle Drive, SE
Grand Rapids,
Michigan 49512
616-975-9260
lelandfurniture.com**

freshcoast collection

2024 Price List

Pricing Effective January 2024



freshcoast price list

+ terms and conditions: table of contents 1

+ terms and conditions, ordering information 2-6

+ freight program 7

+ chair and table size combination guide..... 8

+ shell art index..... 9-10

+ children’s beach stones BSC

+ beach stone collection BS

+ crystal table CYT

+ crystal table low CYLT

+ crystal stool CYS

+ eve chair EV

+ handy stool HA

+ little marquette chair MQ

+ little marquette table MT

+ manitou chair..... MTC

+ manitou table MCT

+ quince chair QC

+ quince table QCT

+ zoon chair ZNC

+ zoon stool ZNS

+ zoon table ZNT

ordering information

All orders must be submitted in writing by e-mail to:
hello@lelandinternational.com

Specify each item by its product code and the corresponding model description, finish, upholstery and options offered in the price list. If the customer's current product order must match a previous order, freshcoast must be notified. A sample product from the original order must be submitted at the expense of the customer to assure uniformity of finish and construction. Orders with missing or incorrect information such as model, finish, color, pricing, etc. will be scheduled upon receipt of correct and complete information.

freshcoast products are specified for and installed in a variety of end user applications. It is the responsibility of the purchasing party to understand the end user's intent and purchase products appropriate for that application. freshcoast takes no responsibility for incorrect specifications. Acceptance and fulfillment of any purchase order does not imply that the product is suitable for a certain application. freshcoast will only warranty products that have been installed in applications for which they were designed.

If multiple delivery schedules are required, the customer must submit separate purchase orders for each delivery date.

acknowledgment

Orders are only accepted by issuance of our formal acknowledgment. It is the purchaser's responsibility to check acknowledgments and invoices for accuracy. If there is any discrepancy, the customer must notify freshcoast within 72 hours. Failure to notify freshcoast within this time period will constitute acceptance of the order as acknowledged, and our acknowledgment is final and binding.

All acknowledgments will contain an estimated ship date. If for some reason the furniture must not ship earlier than the estimated ship date, please specify a "Do not ship before date" in your purchase order. We are not responsible for delays in scheduling or failure to make scheduled ship date due to strikes, lockouts or other labor complications, war, riots, Acts of God, fires, accidents, restraints affecting shipment or credit, reduced supply or excessive cost of fuel or raw material, delays from suppliers, compliance with government regulations or other unforeseen contingencies.

wood finishes

Wood finishes can be light sensitive; therefore, care should be taken to avoid placing chairs in areas exposed to intense natural light. Due to variations common to all wood species, the color and grain characteristics of the finish samples may not exactly match that of the finished product. Custom finishes must meet factory approval and are subject to a \$100.00 minimum net mixing charge. Please allow up to three weeks to prepare the custom wood finish match sample. Orders will not be scheduled or acknowledged until finish material approval is received in writing. Due to limitations of the raw materials and the natural background color of wood, not all colors can be successfully reproduced. The suitability of a color for custom finish matching cannot always be determined beforehand. This is especially true in the case of custom colors submitted on non-wood products. If we are unable to produce a commercial match to your custom color you will be notified at the earliest possible date and no charge will be levied.

laminates

The following are considered to be standard and are usually in stock.

freshcoast tables may be ordered with any laminate recommended for application on horizontal surfaces. For table pricing and lead times using laminates not listed, please contact freshcoast.

FORMICA®

<http://www.formica.com/trade/laminate/swatches/>
or call 800.367.6422

Select solid colors, wood grains or patterns
Select number/name
Select standard finishes
Laminates with -58 (matte finish) are standard

WILSONART®

<http://www.wilsonartcontract.com/pattern-availability/>
or call 800.433.3222

Select laminate finish,
Select freshcoast standard finish -38 (fine velvet texture) or -60 (matte)

PIONITE®

http://www.pionite.com/pionite/pages_pionite/pionite_colors.html
or call 800.746.6483

Select colors
Order standard finish N (suede)

customer's own material (com)

freshcoast reserves the right of preliminary approval of all COM, prior to order acceptance. Even after such preliminary approval, freshcoast reserves the right to reject COM if, upon physical inspection of the COM, it proves unacceptable for use on freshcoast products. When this occurs, the customer will be notified in writing with an explanation of the problem. A written release from the customer will be required for the order to be processed.

freshcoast cannot assume responsibility for durability, appearance or other qualities of customer's own material on the finished product and does not give any warranty with respect to COM. At freshcoast's discretion, additional yardage, labor charges, or handling surcharges may be required as a condition of COM acceptance. COM delivered to freshcoast without proper identification may be refused, and freshcoast shall have no responsibility for loss or any other claims. Excess fabric will not be returned unless specifically requested in writing.

Please contact freshcoast for yardage requirements on all COM fabrics which are patterned or narrower than 54 inches wide. Orders using COM will be rescheduled if the COM has not been received two (2) weeks prior to the original ship date. Every effort will be made to avoid a delay and to complete your order within the standard lead time.

All shipments of COM to freshcoast must be sent prepaid.
COM should be sent to:

freshcoast
5695 Eagle Drive SE
Grand Rapids, Michigan 49512

COM packages must include the following information:

- + Name of customer
- + Purchase order number to which the material is to be applied and freshcoast Sales Order, if known.

Purchase orders specifying COM must include the following:

- + Indicate which side of the fabric is to be exposed (manufacturer's implied face will be used if no side is indicated by the customer).
- + If fabric is a stripe or pattern, specify vertical or horizontal upholstered application. (fabric will be applied off the bolt if no direction is indicated by the customer).
- + COM suppliers' name, fabric number and quantities of pieces to which the material is to be applied.

california technical bulletin 133

TB 133 is a full scale fire performance test of complete articles of seating furniture. Some freshcoast products in combination with a variety of upholstery fabrics have been tested and are in compliance with TB 133. Test documentation is available upon request. If you wish to specify freshcoast products that have not been tested for compliance with TB 133 please consult freshcoast for TB 133 testing cost information.

In order for freshcoast products to comply with TB 133 the foam must be protected with a fire-blocker or a special fire retardant foam must be used. For those products that must comply with TB 133 there will be a net charge for fire blocker laminating or fire retardant foam. Please contact freshcoast for a CAL 133 quotation on all seating.

Since TB 133 tests furniture and not components there are no TB 133 approved fabrics. Fabrics comprised solely or in any combination of the following fibers are more likely to be suitable components for chairs that must comply with TB 133:

Acrylic	Nylon
Vinyl	Animal Hairs
Polyester	Virgin Wool
Cordura	Rayon
Viscose	Cotton
SEF Modacrylic	Modacrylic
Leather	Silk
Worsted Wool	Wool
Spun Nylon	Mohair Trevira

prices

All prices are list prices F.O.B. our factory in Grand Rapids, Michigan 49512. Our pricing includes packing and corrugated cartoning for common carrier shipments. List prices do not include freight, storage, taxes or additional packaging for certain carriers and are subject to change without notice.

We reserve the right to change quotation prices prior to acceptance by the buyer. Quotation prices must be accepted within 30 days or re-submitted for dating and approval. Pricing on orders specifying shipment 90 days or more after the formal date of acknowledgment will be based on pricing prevailing at time of shipment.

resale rights

freshcoast reserves the right to reject any order placed by any customer for any reason, irrespective of whether orders have been previously accepted from such customer, without incurring liability to such customer. No customer shall have a continuing right to buy products from the company except pursuant to a formal dealer agreement or other written agreement covering future supply executed by the company and the reseller. Distribution of the price list or catalog does not itself constitute an offer to sell.

credit and payment terms

An open account may be established for new customers. One bank and three trade references will be required and must be e-mailed to the freshcoast accounting department. Credit will be established upon review and approval of your application.

Allow up to four weeks delay for credit approval. To avoid this delay orders on new accounts must be accompanied by a 50% deposit.

If credit is approved by the time the order is ready for shipment, the balance must be paid within terms. Accounts that are inactive for a twelve month period will automatically be closed and are subject to the above conditions for new accounts. freshcoast may change or cancel credit at its discretion and may request advance payment at any time.

Upon establishment of an open account, terms are "Net 15 Days" after date of invoice with a credit limit established on a per customer basis. 1½ % per month service charge will be added to all past due accounts. Orders will not be processed for past due accounts until the amount due, including any service charge, is paid in full. All custom orders will require a down payment of 50% and will not be scheduled for production until the full down payment is received.

freshcoast reserves the right to revoke the terms of any customer at any time for any reason.

changes and cancellations

Orders are not subject to change or cancellation without factory approval. freshcoast will make every reasonable effort to stop production scheduling, shipment, etc., upon receipt of written notification of changes, cancellations or deferrals stipulated as follows. Approved cancellations, changes, and delivery date extensions may be subject to charges.

order changes

Order changes received prior to production will be charged \$100 net to cover administrative costs. Orders received after production has started, involving only an increase in quantity, will not be assessed a charge. Orders for special finishes are not subject to change after work has been started. Orders for upholstered chairs may not be changed after upholstery cover has been cut. The customer will receive the goods as ordered and be liable for amount due.

cancellations

Cancellations received prior to production will be assessed a \$100 net cancellation charge. Cancellations received after production has been started will be assessed the total accumulated cost of the project plus a \$100 net cancellation charge.

deferred shipments

If the order is complete in the production cycle, charges will be assessed from the completion date in accordance with policy for "Storage by the Manufacturer."

storage by the manufacturer

If the customer cannot accept delivery when merchandise is ready, per acknowledged ship date according to the terms of our acknowledgment, we reserve the right to transfer goods to storage at the customer's expense, and the order will be invoiced at the time of storage. Payment of this invoice will be due on the original terms given to the customer. Storage charges and freight charges for delivery will be invoiced separately upon release of the merchandise from storage and will be due upon receipt of the invoice. Orders put into storage require payment in full and all incurred storage charges must be paid prior to the order being shipped.

shipping

We will ship in accordance with the customer's written instructions. If customer omits specific shipping instructions, we will ship in the manner that we consider to be the best way. All shipments are sent F.O.B. Grand Rapids, Michigan 49512. freshcoast's liability ends when received by the carrier at freshcoast's dock. Title of the goods and risk of loss transfers to the buyer at that time. Freight shall be paid by the buyer unless otherwise acknowledged in writing by freshcoast. We make every effort to ship orders complete and on schedule. We reserve the right to make partial shipments as merchandise is ready. Failure to deliver all the merchandise at one time does not relieve the customer of the obligation to accept and pay for merchandise received.

damage claims

All freshcoast products are thoroughly inspected prior to shipment from our factory and packed to comply with carrier requirements. Customers must carefully inspect all items upon arrival and note any damage on the delivery receipt. Phrasing such as "Subject to Inspection" does not constitute a note of damage and will not be accepted as grounds for honoring a freight claim. A written claim must be filed within 15 days of receipt with the carrier if any obvious or subsequent concealed damage is discovered and still does not guarantee the honoring of any freight claim. Caution: When a clear receipt is obtained by a carrier, freshcoast, nor the carrier, are no longer responsible for damages or shortages. Processing claims for damage and shortages are the responsibility of the buyer unless otherwise specified in writing by freshcoast. At no time can claims be deducted from our invoices.

storage by owner

Due to the inherent nature of wood products, we cannot guarantee any product stored or set in place in an environment where temperature and humidity are not controlled. Temperatures must be maintained within a range of 50°-80° F (10°-27° C); the relative humidity must be maintained between 25% and 40%. These conditions are also recommended for human health standards.

product discrepancy

Errors in products including color, size, other variations, or missing components must be reported to freshcoast within thirty (30) days of delivery. Failure by the purchaser to report any product inaccuracies within thirty (30) days of delivery shall constitute acceptance of the product.

miscellaneous

All costs for furniture installation, removal from service and reinstallation due to damage claims, partial shipments, shipping errors or warranty claims is the responsibility of the customer. freshcoast will not be liable for costs associated with any of the above conditions.

All sizes and weights are considered to be approximate. freshcoast reserves the right to make changes in design and construction or discontinue products without notice. Due to conditions beyond our control all wood products, fabrics and vinyls are subject to variations in color, texture and grain.

Price list specifications supersede all other specifications whether verbal or written, and may not be altered without the written consent of an officer of freshcoast. All clerical errors on any agreement, publication, correspondence, price list, or product literature pieces are subject to correction at any time.

maintenance

Since chairs and tables are installed and used under a variety of conditions, users must make inspections no less than every six months to look for damage or signs of structural fatigue incurred in daily handling, use and abuse. Examinations must include welds, machine screw assemblies and the shell to base fasteners. If problems are discovered that could compromise the structural safety of a chair, it should be immediately removed from service and freshcoast should be notified. Coats and other articles should not be hung on the back of chairs. This practice may cause chairs to be unstable. Chairs are not designed to be placed seat down on table surfaces. Chairs stored in this manner are unstable. The shock of chairs falling from table tops may compromise the structural integrity of the shell/base attachment.

warranty

All merchandise is manufactured in accordance with our high industrial and design standards and is warranted to be free from defects of material and workmanship for a period of (5) five years from the date of delivery or placement in storage. This warranty covers goods under normal use and is in service under conditions for which the merchandise is designed. freshcoast considers normal use to be (5) five days per week (8) eight hours per day. Extended use (multiple shifts, 24 hour facilities, etc) will reduce this warranty to (2) two years. We offer no warranty on chair upholstery materials, plastic laminate table surfaces and operating components other than those expressed by the manufacturer of those components.

Our obligation during this warranty period is limited to repair or replacement at our option. This warranty becomes null and void on any goods repaired or altered by any person not so authorized by freshcoast or any merchandise which has been subject to misuse, improper storage, including placing chairs seat down on tables, negligence, or accident. We make no other warranties either expressed or implied as to any matter whatsoever, including without limitation, the condition of the merchandise, its merchantability, or its fitness for any particular user or purpose.

All claims will be processed by the Customer Care Department. All returns must be authorized in writing. Merchandise authorized for return and subsequent repair or replacement merchandise shall be removed from service. All shipping, packaging, and installation charges shall be at the expense of the customer. Since furniture is installed and used under a variety of conditions, users are required to make inspections every six months to look for damage or signs of structural fatigue incurred in daily handling, use, or abuse. Inspections must include, but are not limited to, the tightening of bolts and fasteners, and the lubrication of mechanisms.

Failure to properly maintain freshcoast products will void this warranty.

freshcoast will not be liable for loss of time, inconvenience, commercial loss, or incidental or consequential damages that may result from a warranty claim.

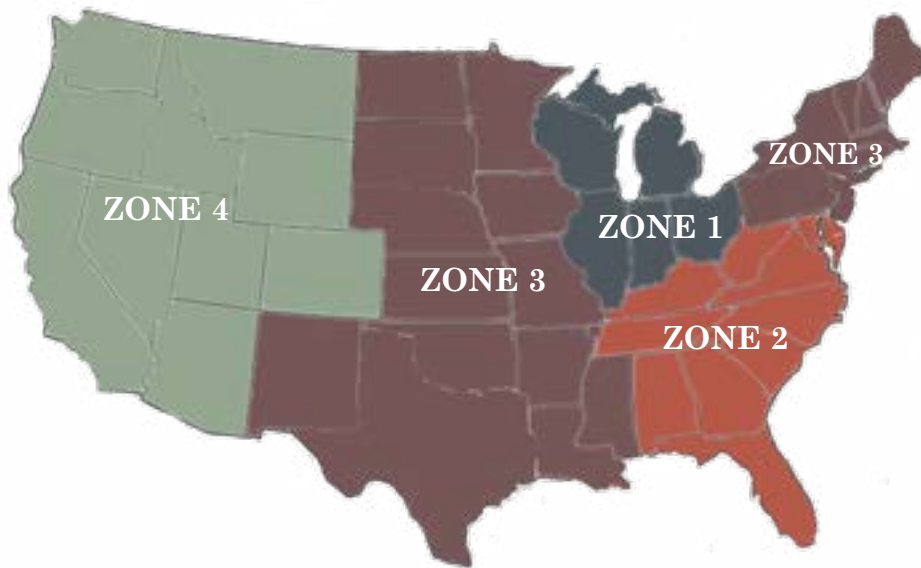

Zone 1 (4%)	Zone 2 (5%)	Zone 3 (6%)	Zone 3 (6%) CONT.	Zone 4 (7%)
Indiana	Alabama	Arkansas	New Hampshire	Arizona
Illinois	Delaware	Connecticut	New Jersey	California
Michigan	Florida	Iowa	New Mexico	Colorado
Ohio	Georgia	Kansas	New York	Idaho
Wisconsin	Kentucky	Louisiana	North Dakota	Montana
	Maryland	Maine	Oklahoma	Nevada
	North Carolina	Massachusetts	Pennsylvania	Oregon
	South Carolina	Minnesota	Rhode Island	Utah
	Tennessee	Mississippi	South Dakota	Washington
	Virginia	Missouri	Texas	Wyoming
	Washington DC	Nebraska	Vermont	
	West Virginia			

Overview

Leland Furniture's Freight Program is offered to all customers for convenient and competitive freight prices in the continental United States.

How It Works

1. Determine the LIST value of your order.
2. Determine the zone to which the freight will be shipping (Zones 1-4)
3. Calculate your freight charges by multiplying the list price and applicable zone charges (e.g.: \$10,000 LIST order shipping to Arizona is $\$10,000 \times 0.07 = \700 NET freight).
4. Verify that your calculated charges meet or exceed minimums.
5. Note on your PO "Freight determined by Leland Freight Program".

Zone Percentages and Minimums

Zone 1	4%	Minimum \$350
Zone 2	5%	Minimum \$350
Zone 3	6%	Minimum \$350
Zone 4	7%	Minimum \$350

Remember

Freight percentages are based on LIST price of order.

Leland Furniture Freight Program is based on dockside delivery only. Residential Delivery, Inside Delivery, etc. will incur additional charges; please contact Leland Customer Service for current prices.

Freight is FOB Grand Rapids, MI 49512; the receiving company is responsible for noting any damage at the time of delivery on the Delivery Receipt. Leland Furniture assumes no responsibility for freight damage, either noted on delivery receipt or concealed.

As fuel prices fluctuate, Leland Furniture reserves the right to add necessary fuel surcharges.

Leland Furniture reserves the right to change or discontinue the Freight Program at any time.

recommended chair height and table combination

Size pairings are based on the seat height of the chair.
Table heights are paired with seating as ergonomically appropriate.
These suggestions are based on international averages for child size by age and are considered to be approximate only.

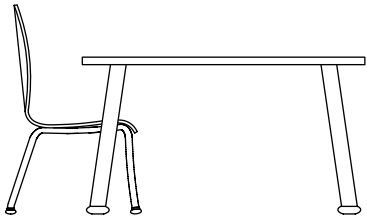

ages 4-9
12" seat height
20" table height

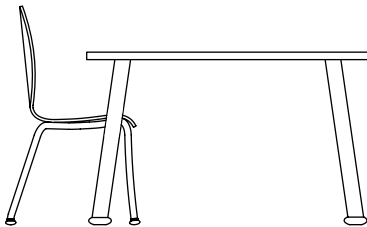

ages 7-12
14" seat height
22" table height

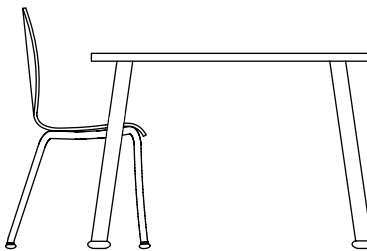

ages 10-15
16" seat height
25" table height

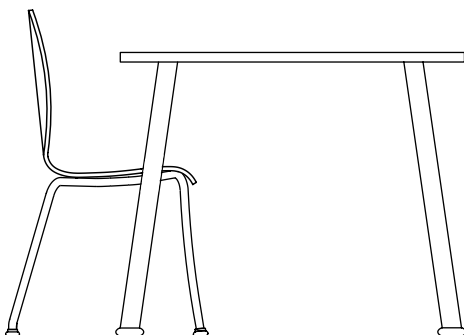

adult
18" seat height
29" table height

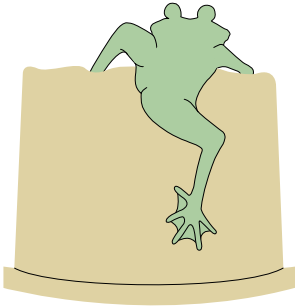

eve creatures

A CNC laser is used to cut a chair shell forming a three dimensional image on the chair back. Often, one side of the chair will show the creatures front side characteristics (such as eyes and nose) and the opposite side will show the creatures backside characteristics (such as a tail). Laser engraving and laser cutting is typically combined to create the different characteristics of the eve creature. See page EV3 for a complete list of eve creatures.

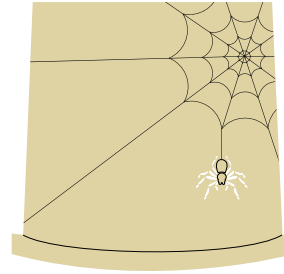

laser engraving

A CNC laser is used to make an engraving that penetrates the surface of the chair shell. The shell may be engraved on either or both sides.

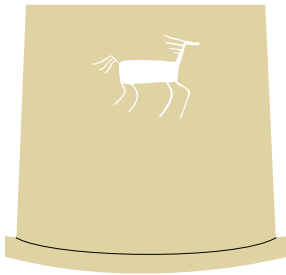

laser cutout

A CNC laser is used to cut through the back of the shell, forming an opening. This space creates an image that is visible from both sides of the chair shell.

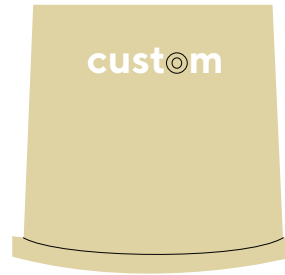

custom

You dream it, we can do it.

freshcoast shell art collections

Please refer to the freshcoast children’s brochure for details on scale and placement of shell art. If no shell art is desired, use code F999.

swamp things

grade 1

description
code



snake
(F001)



lizard
(F002)



tree frog
(F003)



turtle
(F004)

safari

grade 1

description
code



rhinoceros
(F005)



elephant
(F006)



lioness
(F007)



ostrich
(F008)



giraffe
(F009)

petroglyphs

grade 1

description
code



ram
(F010)



antelope
(F011)



deer
(F012)



caribou
(F013)



horse
(F014)

birds

grade 2

description
code



hummingbird
(F015)



owl
(F016)



woodpecker
(F017)



dove
(F018)

celestial

grade 1&2

description
code



moon
(F019)



sun
(F020)
grade 1



star
(F021)



saturn
(F022)



shooting star
(F023)
grade 2



moon among stars
(F024)

Original artwork is property of freshcoast Inc. All rights reserved. No part of this artwork may be reproduced or transmitted in any form or by any electronic means, including photocopying, or by any information or retrieval system, without written permission from the President or Director of freshcoast, Inc.

freshcoast shell art collections, continued

Please refer to the freshcoast children’s brochure for details on scale and placement of shell art. If no shell art is desired, use code F999.

sea life
grade 1&2

description
code

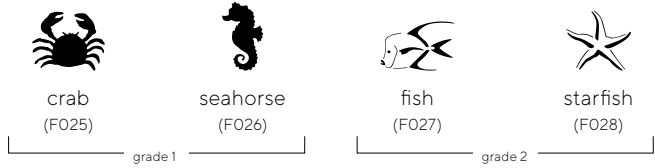

animal tracks
grade 2

description
code



shapes
grade 1

description
code

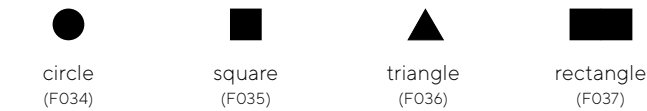

dinosaurs
grade 1

description
code



insects
grade 1&2

description
code

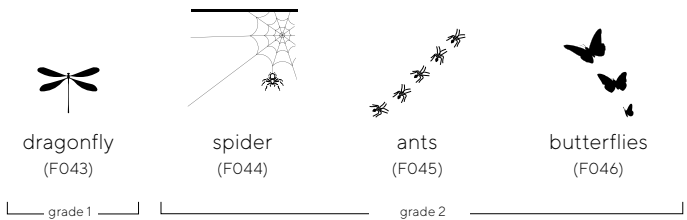

freshcoast collection
**CHILDREN'S
BEACH STONES**

2024 Price List

Pricing Effective: January 2024



freshcoast
by LELAND

children's beach stones price list

+ beach stones: table of contents..... BSC2

+ beach stones specification information BSC3

+ beach stones specification example..... BSC4

+ beach stones BSC5-BSC6

model

DESCRIPTION	CODE
Beach Stone A	BSA
Beach Stone B	BSB
Beach Stone B with wood back	BSBW
Beach Stone C	BSC
Beach Stone C with wood back	BSCW
Beach Stone D	BSD

Wood back is only offered on B and C benches.

back finish (wood back only)

DESCRIPTION	CODE	DESCRIPTION	CODE
natural	11M	arctic ii	16M
medium	13M	ink ii	18M
neutral	15M	limelight	33M
white wash II	30M	caribbean II	48M
transparent black	29M	soda red	46M
graphite	25M	tangerine	40M
		dolphin II	50M

shell art (wood back only)

Due to thickness of the wood back, only shell art listed below is available. When viewed from the front, all shell art will be placed on the upper left area of back.

DESCRIPTION	CODE	DESCRIPTION	CODE
moon	F019	circle	F034
sun	F020	square	F035
star	F021	triangle	F036

upholstery selection

Please refer to freshcoast Textile Program which features textiles and leathers from the following partners:

- Camira
- Carnegie
- CF Stinson
- Green Hides
- Maharam
- Unika Vaev

The complete grade list can be found at www.fc.studio/textile-partners or you can specify COM/COL. Due to the design of this product, it is recommended that all non pre-approved textile be tested for compatibility.

Contact freshcoast for yardage requirements on textiles with repeats.

base finish

Black textured powder coat

SPECIFICATIONS REQUIRED TO CREATE THE PRODUCT CODE

- + **Model**
- + **Wood Back Finish (when applicable)**
- + **Wood Back Shell Art (when applicable)**
- + **Upholstery Selection**

B S B W - **1 1** - **F 0 3 4** - **C O M**
MODEL BACK FINISH (WHEN APPLICABLE) SHELL ART (WHEN APPLICABLE) UPHOLSTERY SELECTION

model

Beach Stone B with wood back (BSBW)

back finish

Natural (11)

shell art

Shapes, Circle (F034)

upholstery selection

Upholstered (COM)



children's seating

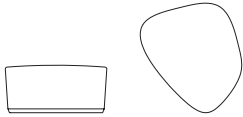

beach stone A	model	com/col	a	b	c	d	e	f	g	h	i	j	k	l
fully upholstered	BSA	\$1016	1128	1183	1239	1295	1352	1407	1463	1520	1574	1631	1687	1743
W26.75 D28.75 H12.5		COM yardage: 2 yds. Contact freshcoast customer care for COL requirements, textile testing requirements and yardage requirements for textiles with repeats.												

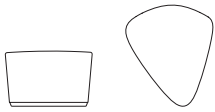

beach stone B	model	com/col	a	b	c	d	e	f	g	h	i	j	k	l
fully upholstered	BSB	\$1064	1162	1209	1257	1305	1353	1401	1448	1497	1545	1592	1641	1688
W23 D26.5 H14.5		COM yardage: 1.5 yds. Contact freshcoast customer care for COL requirements, textile testing requirements and yardage requirements for textiles with repeats.												

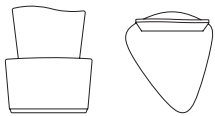

beach stone B	model	list price/grade	com/col	a	b	c	d	e	f	g	h	i	j	k	l
fully upholstered, wood back	BSBW	plain back	\$1332	1428	1477	1524	1572	1621	1668	1717	1766	1813	1861	1908	1957
		shell art	\$1388	1483	1532	1579	1627	1675	1722	1771	1820	1867	1916	1963	2011
W23 D26.5 H28.25 SH14.5		COM yardage: 1.5 yds. Contact freshcoast customer car for COL requirements, textile testing requirements and yardage requirements for textiles with repeats.													

to specify: please refer to pages 3-4 for complete specifying information. Specify all products by their product code.

pricing effective: January 2024

children's seating



beach stone C	model	com/col	a	b	c	d	e	f	g	h	i	j	k	l
fully upholstered	BSC	\$1089	1186	1234	1281	1330	1378	1425	1475	1522	1570	1617	1666	1714
W25.5 D22.25 H16.5		COM yardage: 2 yds. Contact freshcoast customer care for COL requirements, textile testing requirements and yardage requirements for textiles with repeats.												

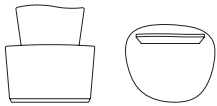

beach stone C	model		com/col	a	b	c	d	e	f	g	h	i	j	k	l
fully upholstered, wood back	BSCW	plain back	\$1359	1456	1503	1551	1599	1648	1695	1743	1791	1839	1887	1936	1984
W25.5 D22.25 H27.75 SH16.5		shell art	\$1411	1506	1556	1604	1651	1699	1748	1795	1844	1893	1940	1987	2034
			COM yardage: 2 yds. Contact freshcoast customer care for COL requirements, textile testing requirements and yardage requirements for textiles with repeats.												



beach stone D	model	list price/grade	com/col	a	b	c	d	e	f	g	h	i	j	k	l
fully upholstered	BSD		\$1125	1318	1414	1510	1606	1701	1798	1894	1990	2087	2182	2278	2375
W39 D24.75 H24.5			COM yardage: 3 yds. Contact freshcoast customer care for COL requirements, textile testing requirements and yardage requirements for textiles with repeats.												

to specify: please refer to pages 3-4 for complete specifying information. Specify all products by their product code.

pricing effective: January 2024

freshcoast collection
BEACH STONES

2024 Price List

Pricing Effective: January 2024



beach stones price list

+ beach stones: table of contents..... BS2
+ beach stones specification information BS3
+ beach stones specification example..... BS4
+ beach stones seating BS5
+ beach stone tables..... BS7

beach stones specification information

model

DESCRIPTION	CODE
Beach Stone E	BSE
Beach Stone E with casters	BSEM
Beach Stone F	BSF
Beach Stone F with casters	BSFM
Beach Stone G	BSG
Beach Stone G with casters	BSGM
Beach Stone H	BSH
Beach Stone I	BSI
Beach Stone J	BSJ
Beach Stone K	BSK
Beach Stone L	BSL

product weights

DESCRIPTION	LBS
Beach Stone E - BSE	50
Beach Stone F - BSF	50
Beach Stone G - BSG	50
Beach Stone H - BSH	50
Beach Stone I - BSI	50
Beach Stone J - BSJ	50
Beach Stone K - BSK	50
Beach Stone L - BSL	50

upholstery selection

Please refer to freshcoast Textile Program which features textiles and leathers from the following partners:

- Camira
- Carnegie
- CF Stinson
- Green Hides
- Maharam
- Unika Vaev

The complete grade list can be found at www.fc.studio/textile-partners or you can specify COM/COL. Due to the design of this product, it is recommended that all non pre-approved textile be tested for compatibility. Contact freshcoast for yardage requirements on textiles with repeats.

base finish

Black textured powder coat

table top finish

LAMINATE

DESCRIPTION	CODE
Black Laminate	LBK
White Laminate	LWH

SOLID SURFACE

DESCRIPTION	CODE
Black Corian®	CB
White Corian®	CW
Grey Corian®	CG

GLASS

DESCRIPTION	CODE
Black Back painted Glass	BG
White Back painted Glass	WG

caster options

Available only on Beach Stone Models E, F, and G.

DESCRIPTION	CODE
Hard Floor	HF
Soft Floor	SF

SPECIFICATIONS REQUIRED TO CREATE THE PRODUCT CODE

- + Model
- + Upholstery Selection
- + Table Top Finish (when applicable)

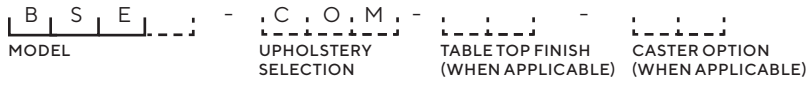

model

Beach Stone E (BSE)

upholstery selection

Upholstered (COM)

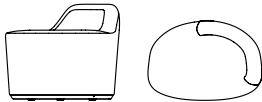

TABLE TOP FINISH
When applicable

seating



beach stone E	model	com/col	a	b	c	d	e	f	g	h	i	j	k	l
fully upholstered	BSE	\$1615	1806	1903	2000	2095	2192	2287	2383	2480	2575	2671	2768	2864
W32 D24 H25 SH18		COM yardage: 2.5 yds. Contact freshcoast customer care for COL requirements, textile testing requirements and yardage requirements for textiles with repeats.												



beach stone E with casters	model	com/col	a	b	c	d	e	f	g	h	i	j	k	l
fully upholstered, locking caster base	BSEM-HF	\$1685	1876	1972	2069	2165	2261	2357	2452	2549	2644	2740	2838	2933
hard or soft floor casters	BSEM-SF	\$1699	1890	1987	2084	2179	2276	2371	2467	2564	2659	2755	2852	2948
W32 D24 H25.25 SH18.25		COM yardage: 2.5 yds. Contact freshcoast customer care for COL requirements, textile testing requirements and yardage requirements for textiles with repeats.												

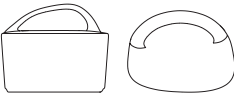

beach stone F	model	com/col	a	b	c	d	e	f	g	h	i	j	k	l
fully upholstered	BSF	\$1589	1780	1876	1973	2069	2165	2261	2357	2452	2549	2644	2741	2838
W32 D24 H26 SH18		COM yardage: 2.5 yds. Contact freshcoast customer care for COL requirements, textile testing requirements and yardage requirements for textiles with repeats.												

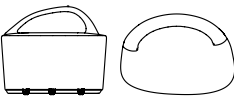

beach stone F with casters	model	com/col	a	b	c	d	e	f	g	h	i	j	k	l
fully upholstered, locking caster base	BSFM-HF	\$1658	1850	1945	2043	2138	2234	2330	2426	2522	2618	2714	2810	2907
hard or soft floor casters	BSFM-SF	\$1673	1864	1960	2057	2153	2249	2345	2441	2536	2633	2728	2825	2922
W32 D24 H26.25 SH18.25		COM yardage: 2.5 yds. Contact freshcoast customer care for COL requirements, textile testing requirements and yardage requirements for textiles with repeats.												

to specify: please refer to pages 3-4 for complete specifying information. Specify all products by their product code.

seating



beach stone G	model	com/col	a	b	c	d	e	f	g	h	i	j	k	l
fully upholstered W32 D24 H31 SH18	BSG	\$1608	1801	1897	1993	2089	2184	2280	2377	2472	2569	2665	2761	2856
		COM yardage: 2.5 yds. Contact freshcoast customer care for COL requirements, textile testing requirements and yardage requirements for textiles with repeats.												

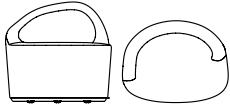

beach stone G with casters	model	com/col	a	b	c	d	e	f	g	h	i	j	k	l
fully upholstered, locking caster base	BSGM-HF	\$1677	1871	1966	2063	2158	2254	2349	2446	2541	2638	2735	2830	2926
hard or soft floor casters W32 D24 H31.25 SH18.25	BSGM-SF	\$1692	1885	1981	2077	2173	2268	2364	2461	2556	2653	2749	2845	2940
		COM yardage: 2.5 yds. Contact freshcoast customer care for COL requirements, textile testing requirements and yardage requirements for textiles with repeats.												



beach stone H	model	com/col	a	b	c	d	e	f	g	h	i	j	k	l
fully upholstered W48 D18 H18	BSH	\$1071	1263	1359	1456	1551	1648	1743	1839	1936	2031	2127	2224	2320
		COM yardage: 2.5 yds. Contact freshcoast customer care for COL requirements, textile testing requirements and yardage requirements for textiles with repeats.												



beach stone I	model	com/col	a	b	c	d	e	f	g	h	i	j	k	l
fully upholstered W33 D22 H18	BSI	\$965	1094	1157	1221	1285	1349	1413	1477	1540	1605	1668	1733	1797
		COM yardage: 1.75 yds. Contact freshcoast customer care for COL requirements, textile testing requirements and yardage requirements for textiles with repeats.												

to specify: please refer to pages 3-4 for complete specifying information. Specify all products by their product code.

tables

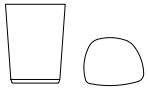

beach stone J	model	top finish	com/col	a	b	c	d	e	f	g	h	i	j	k	l
upholstered w/ table	BSJ	Laminate	\$1128	1191	1224	1255	1287	1319	1352	1383	1416	1447	1479	1511	1544
		Corian	\$1691	1788	1836	1882	1930	1979	2028	2075	2124	2172	2218	2266	2315

W17 D13 H22

COM yardage: 1 yd.

Contact freshcoast customer care for COL requirements, textile testing requirements and yardage requirements for textiles with repeats.

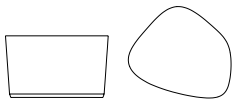

beach stone K	model	top finish	com/col	a	b	c	d	e	f	g	h	i	j	k	l
upholstered w/ table	BSK	Laminate	\$1128	1255	1319	1383	1447	1511	1574	1640	1703	1768	1832	1896	1960
		Corian	\$1691	1882	1979	2075	2172	2266	2363	2460	2554	2652	2747	2844	2938

W30 D27 H18

COM yardage: 2 yds.

Contact freshcoast customer care for COL requirements, textile testing requirements and yardage requirements for textiles with repeats.

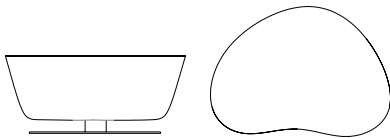

beach stone L	model	top finish	com/col	a	b	c	d	e	f	g	h	i	j	k	l
upholstered w/ table	BSL	Laminate	\$3526	3719	3814	3911	4006	4102	4197	4294	4391	4486	4583	4678	4774
		Corian	\$5290	5578	5721	5866	6009	6153	6296	6441	6586	6730	6874	7018	7161

W47 D34 H20

COM yardage: 3 yds.

Contact freshcoast customer care for COL requirements, textile testing requirements and yardage requirements for textiles with repeats.



beach stone L	model	com/col	a	b	c	d	e	f	g	h	i	j	k	l
upholstered w/ backpainted glass	BSL	\$3848	4040	4135	4231	4328	4423	4520	4616	4712	4807	4904	5000	5095

W47 D34 H20

COM yardage: 3 yds.

Contact freshcoast customer care for COL requirements, textile testing requirements and yardage requirements for textiles with repeats.

to specify: please refer to pages 3-4 for complete specifying information. Specify all products by their product code.



freshcoast collection

**CRYSTAL
CHILDREN'S TABLE**

2024 Price List

Pricing Effective: January 2024



freshcoast
by LELAND

crystal children's table price list

- + crystal table: table of contents CYT2
- + crystal table specification information CYT3
- + crystal table specification example CYT4
- + crystal 20 inch height table CYT5
- + crystal 22 inch height table CYT6
- + crystal 25 inch height table CYT7

model

DESCRIPTION	CODE
Crystal children's table	CYT

table height

DESCRIPTION	CODE
20 inch table height	20H
22 inch table height	22H
25 inch table height	25H

base finish

Select from freshcoast Colors I & II.

top size

ROUND CODE	CODE	SQUARE	CODE	RECTANGLE	CODE
36 dia	36D	36x36	3636	30x60	3060
42 dia	42D	42x42	4242		
48 dia	48D	48x48	4848		

top surface finish or color

WOOD TOP:

DESCRIPTION	CODE	DESCRIPTION	CODE
natural	11M	arctic ii	16M
medium	13M	ink ii	18M
neutral	15M	limelight	33M
white wash II	30M	caribbean II	48M
transparent black	29M	soda red	46M
graphite	25M	tangerine	40M
		dolphin II	50M

top surface finish or color, cont.

LAMINATE TOP:

DESCRIPTION	CODE
Identify manufacturer, laminate code, & color	L

Please refer to the freshcoast Terms and Conditions for a listing of standard laminates. For table pricing in laminates not listed, please contact freshcoast for a quotation.

edge type

SOFT VINYL EDGE:

DESCRIPTION	CODE
13/16" flat PVC	V2



WOOD EDGE:

DESCRIPTION	CODE
1" flat plywood	W2



edge finish or color

SOFT VINYL EDGE:

DESCRIPTION	CODE
black	B
white	W
grey	G

WOOD EDGE:

Select from freshcoast Colors I & II.

Wood top with wood edge must be specified in the same finish. Laminate top with wood edge may be specified in any freshcoast finish.

SPECIFICATIONS REQUIRED TO CREATE THE PRODUCT CODE

- + Model
- + Table Height
- + Base Finish
- + Top Size
- + Top Surface Finish or Color
- + Edge Type
- + Edge Finish or Color

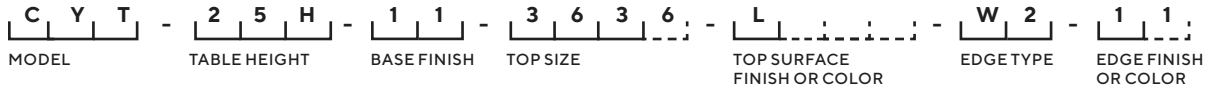

MODEL

Crystal children's table (CYT)

TABLE HEIGHT

25 inch table height (25H)

BASE FINISH

Natural (11)

TOP SIZE

36 X 36 (3636)

TOP SURFACE FINISH OR COLOR

Laminate (L)

EDGE TYPE

1 inch flat plywood (W2)



EDGE FINISH OR COLOR

Natural (11)

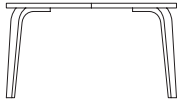

20 inch height





crystal table	model	top size/code	list price/edge codes	V2	W2
curved plywood base	CYT-20H	wood top			
H20		36 dia – 36D		\$1412	1763
 round	 square	42 dia – 42D		\$1451	1812
	 rectangle	48 dia – 48D		\$1489	1860
36 DIA	36 x 36	36 x 36 – 3636		\$1420	1776
42 DIA	42 x 42	42 x 42 – 4242		\$1456	1823
48 DIA	48 x 48	48 x 48 – 4848		\$1495	1871
		30 x 60 – 3060		\$1454	1817
		laminatE top			
		36 dia – 36D		\$1377	1719
		42 dia – 42D		\$1413	1767
		48 dia – 48D		\$1452	1813
		36 x 36 – 3636		\$1383	1729
		42 x 42 – 4242		\$1421	1777
		48 x 48 – 4848		\$1456	1824
		30 x 60 – 3060		\$1420	1774

to specify: please refer to pages 3–4 for complete specifying information. Specify all products by their product code.

pricing effective: January 2024

22 inch height







crystal table	model	top size/code	list price/edge codes	V2	W2
curved plywood base	CYT-22H	wood top			
H22		36 dia – 36D	\$1446	1810	
 round	 square	42 dia – 42D	\$1486	1858	
	 rectangle	48 dia – 48D	\$1524	1906	
36 DIA	36 x 36	36 x 36 – 3636	\$1454	1823	
42 DIA	42 x 42	42 x 42 – 4242	\$1493	1871	
48 DIA	48 x 48	48 x 48 – 4848	\$1531	1917	
		30 x 60 – 3060	\$1490	1867	
		laminatE top			
		36 dia – 36D	\$1413	1767	
		42 dia – 42D	\$1452	1813	
		48 dia – 48D	\$1489	1859	
		36 x 36 – 3636	\$1421	1777	
		42 x 42 – 4242	\$1456	1824	
		48 x 48 – 4848	\$1495	1871	
		30 x 60 – 3060	\$1455	1821	

to specify: please refer to pages 3-4 for complete specifying information. Specify all products by their product code.

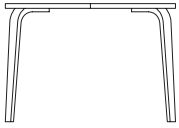
pricing effective: January 2024

25 inch height



crystal table	model	top size/code	list price/edge codes	V2	W2
curved plywood base	CYT-25H	wood top			
H25		36 dia – 36D		\$1489	1860
 round		42 dia – 42D		\$1526	1906
 square		48 dia – 48D		\$1566	1955
 rectangle		36 x 36 – 3636		\$1495	1871
36 DIA		42 x 42 – 4242		\$1532	1917
42 DIA		48 x 48 – 4848		\$1571	1965
48 DIA		30 x 60 – 3060		\$1529	1915
		laminatE top			
		36 dia – 36D		\$1452	1813
	42 dia – 42D		\$1489	1859	
	48 dia – 48D		\$1524	1905	
	36 x 36 – 3636		\$1456	1824	
	42 x 42 – 4242		\$1495	1871	
	48 x 48 – 4848		\$1531	1916	
	30 x 60 – 3060		\$1493	1867	

to specify: please refer to pages 3–4 for complete specifying information. Specify all products by their product code.

pricing effective: January 2024

freshcoast collection

**CRYSTAL
CHILDREN'S LOW TABLE**

2024 Price List

Pricing Effective January 2024



freshcoast
by LELAND

crystal children's low table price list

- + crystal low table: table of contents..... CYLT2
- + crystal low table specification information..... CYLT3
- + crystal low table specification example CYLT4
- + crystal 12 inch height low table..... CYLT5
- + crystal 14 inch height low table..... CYLT6
- + crystal 16 inch height low table..... CYLT7
- + crystal 18 inch height low table..... CYLT8

model

DESCRIPTION	CODE
Crystal low table	CYLT

low table height

DESCRIPTION	CODE
12 inch low table height	12H
14 inch low table height	14H
16 inch low table height	16H
18 inch low table height	18H

base finish

Select from freshcoast Colors I & II.

top size

ROUND	CODE
26 dia	26D
36 dia	36D
42 dia	42D

top surface finish or color

WOOD TOP:			
DESCRIPTION	CODE	DESCRIPTION	CODE
natural	11M	arctic ii	16M
medium	13M	ink ii	18M
neutral	15M	limelight	33M
white wash II	30M	caribbean II	48M
transparent black	29M	soda red	46M
graphite	25M	tangerine	40M
		dolphin II	50M

top surface finish or color, cont.

LAMINATE TOP:

DESCRIPTION	CODE
Identify manufacturer, laminate code, & color	L

Please refer to the freshcoast Terms and Conditions for a listing of standard laminates. For low table pricing in laminates not listed, please contact freshcoast for a quotation.

MARKER BOARD TOP:

DESCRIPTION	CODE
White surface for non-permanent dry erase markers.	M

Marker board top with W2 edge has Natural 11 edge finish.

edge type

SOFT VINYL EDGE:		WOOD EDGE:	
DESCRIPTION	CODE	DESCRIPTION	CODE
13/16" flat PVC	V2	1" flat plywood	W2



edge finish or color

SOFT VINYL EDGE:

DESCRIPTION	CODE
black	B
white	W
grey	G

WOOD EDGE:

Select from freshcoast Colors

Wood top with wood edge must be specified in the same finish. Laminate top with wood edge may be specified in any freshcoast finish. Markerboard tops with wood edge have Natural 11 edge finish.

SPECIFICATIONS REQUIRED TO CREATE THE PRODUCT CODE

- + Model
- + Low Table Height
- + Base Finish
- + Top Size
- + Top Surface Finish or Color
- + Edge Type
- + Edge Finish or Color



MODEL

Crystal low table (CYLT)

LOW TABLE HEIGHT

16 inch low table height (16H)

BASE FINISH

Natural (11)

TOP SIZE

36 dia (36D)

TOP SURFACE FINISH OR COLOR

Markerboard (M)

EDGE TYPE

1 inch flat plywood (W2)

EDGE FINISH OR COLOR

Natural (11)



12 inch height

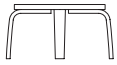

crystal low table

model

top size/code

list price/edge codes

V2

W2

curved plywood base

CYLT-12H

wood top

H 12

26 dia – 26D

\$705

882



round

36 dia – 36D

\$801

1001

26 DIA

42 dia – 42D

\$871

1089

36 DIA

laminatE top

42 DIA

26 dia – 26D

\$681

853

36 dia – 36D

\$776

972

42 dia – 42D

\$847

1060

marker board top

26 dia – 26D

\$1036

1294

36 dia – 36D

\$1367

1710

42 dia – 42D

\$1700

2127

to specify: please refer to pages 3–4 for complete specifying information. Specify all products by their product code.

pricing effective: January 2024

CYLT5

14 inch height

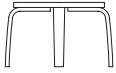

crystal low table	model	top size/code	list price/edge codes	V2	W2
curved plywood base H14  round 26 DIA 36 DIA 42 DIA	CYLT-14H	wood top			
		26 dia – 26D	\$782	978	
		36 dia – 36D	\$878	1096	
		42 dia – 42D	\$948	1185	
		lamine top			
		26 dia – 26D	\$758	948	
		36 dia – 36D	\$853	1067	
		42 dia – 42D	\$924	1154	
		marker board top			
		26 dia – 26D	\$1112	1389	
		36 dia – 36D	\$1444	1803	
		42 dia – 42D	\$1778	2220	

to specify: please refer to pages 3–4 for complete specifying information. Specify all products by their product code.

pricing effective: January 2024

CYLT6

16 inch seat height

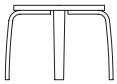

crystal low table

model

top size/code

list price/edge codes

V2

W2

curved plywood base

CYLT-16H

wood top

H16

26 dia – 26D

\$839

1047



round

36 dia – 36D

\$934

1167

26 DIA

42 dia – 42D

\$1005

1256

36 DIA

lamine top

42 DIA

26 dia – 26D

\$815

1019

36 dia – 36D

\$910

1137

42 dia – 42D

\$982

1226

marker board top

26 dia – 26D

\$1169

1458

36 dia – 36D

\$1501

1876

42 dia – 42D

\$1835

2294

to specify: please refer to pages 3–4 for complete specifying information. Specify all products by their product code.

pricing effective: January 2024

CYLT7

18 inch seat height

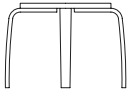

crystal low table

model

top size/code

list price/edge codes

V2

W2

curved plywood base

CYLT-18H

wood top

H18

26 dia – 26D

\$839

1096



36 dia – 36D

\$934

1215

round

42 dia – 42D

\$1043

1305

26 DIA

lamine top

36 DIA

26 dia – 26D

\$853

1067

42 DIA

36 dia – 36D

\$948

1185

42 dia – 42D

\$1020

1274

marker board top

26 dia – 26D

\$1209

1509

36 dia – 36D

\$1539

1925

42 dia – 42D

\$1873

2341

to specify: please refer to pages 3–4 for complete specifying information. Specify all products by their product code.

pricing effective: January 2024

CYLT8

freshcoast collection

**CRYSTAL
CHILDREN'S STOOL**

2024 Price List
Pricing Effective: January 2024



freshcoast
by LELAND

crystal children's stool price list

- + crystal stool: table of contents CYS2
- + crystal stool specification information..... CYS3
- + crystal stool specification example CYS4
- + crystal 12 inch stool CYS5
- + crystal 14 inch stool CYS6
- + crystal 16 inch stool CYS7
- + crystal 18 inch stool CYS8

model

DESCRIPTION	CODE
Crystal stool	CYS

seat height

DESCRIPTION	CODE
12 inch seat height	SH12
14 inch seat height	SH14
16 inch seat height	SH16
18 inch seat height	SH18

base finish

Select from freshcoast Colors I & II.

seat size

ROUND	CODE
18 dia	18D
26 dia	26D
36 dia	36D

seat surface finish or color

WOOD SEAT:			
DESCRIPTION	CODE	DESCRIPTION	CODE
natural	11M	arctic ii	16M
medium	13M	ink ii	18M
neutral	15M	limelight	33M
white wash II	30M	caribbean II	48M
transparent black	29M	soda red	46M
graphite	25M	tangerine	40M
		dolphin II	50M

top surface finish or color, cont.

UPHOLSTERED SEAT:

DESCRIPTION	CODE
Customer's Own Material	COM

Upholstery is Customer's Own Material (COM). Due to the design of this product, it is required that all non pre-approved textiles be tested for compatibility. Untested textiles will not be accepted. Contact freshcoast for yardage requirements on textiles with repeats.

Please refer to freshcoast Textile Program which features textiles and leathers from the following partners:

- Camira
- Carnegie
- CF Stinson
- Green Hides
- Maharam
- Unika Vaev

The complete grade list can be found at www.fc.studio/textile-partners or you can specify COM/COL. Due to the design of this product, it is recommended that all non pre-approved textile be tested for compatibility.

edge type

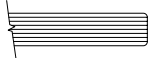
SOFT VINYL EDGE:		WOOD EDGE:	
DESCRIPTION	CODE	DESCRIPTION	CODE
13/16" flat PVC	V2	1" flat plywood	W2
			

*upholstered seat does not require an edge selection

edge finish or color

SOFT VINYL EDGE:

DESCRIPTION	CODE
black	B
white	W
grey	G

WOOD EDGE:

Select from freshcoast Colors I & II.

Wood top with wood edge must be specified in the same finish.

SPECIFICATIONS REQUIRED TO CREATE THE PRODUCT CODE

- + **Model**
- + **Seat Height**
- + **Base Finish**
- + **Seat Size**
- + **Top Surface Finish / Color / Upholstery**
- + **Edge Type (when applicable)**
- + **Edge Finish or Color (when applicable)**

C Y S - **S H 1 6** - **1 1** - **3 6 D** - **6 5** - **W 2** - **6 5**
MODEL SEAT HEIGHT BASE FINISH SEAT SIZE TOP SURFACE FINISH COLOR/UPHOLSTERY EDGE TYPE (WHEN APPLICABLE) EDGE FINISH OR COLOR (WHEN APPLICABLE)

MODEL

Crystal stool (CYS)

SEAT HEIGHT

16 inch seat height (SH16)

BASE FINISH

Natural (11)

SEAT SIZE

36 dia (36D)

TOP SURFACE FINISH / COLOR / UPHOLSTERY

Lime (65)

EDGE TYPE

1 inch flat plywood (W2)

EDGE FINISH OR COLOR

Lime (65)

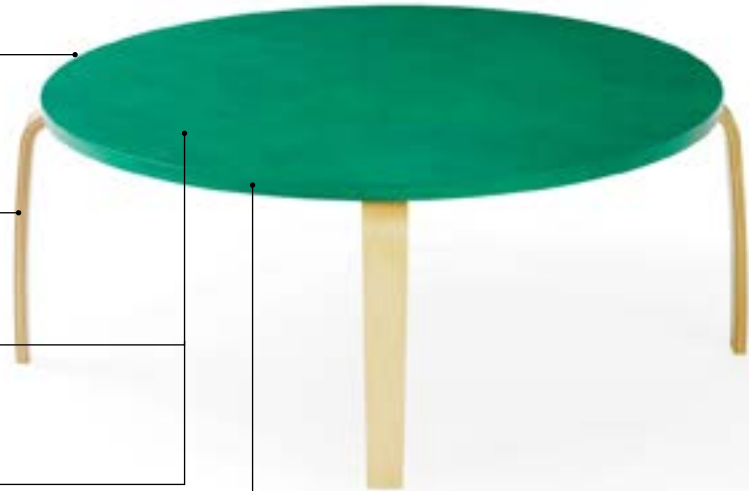

12 inch seat height

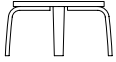

crystal stool	model	list price/grade	list price/edge codes	V2	W2
12" stool, curved plywood base, wood seat	CYS-SH12	18 dia – 18D		\$661	827
		26 dia – 26D		\$750	937
		36 dia – 36D		\$860	1077

H12



round

18 DIA

26 DIA

36 DIA

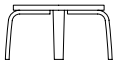

crystal stool	model	list price/grade	com/col	a	b	c	d	e	f	g	h	i	j	k	l
12" stool, curved plywood base, upholstered seat	CYS-SH12	18 dia – 18D	\$874	917	939	959	981	1003	1024	1045	1067	1088	1110	1131	1152
		26 dia – 26D	\$983	1041	1069	1098	1126	1155	1184	1212	1241	1269	1298	1326	1355
		36 dia – 36D	\$1124	1210	1253	1295	1338	1382	1424	1467	1509	1553	1595	1638	1681

H12



round

18 DIA

26 DIA

36 DIA

COM yardage: 18 dia: ¾ yd, 26 dia: 1 yd, 36 dia 1½ yds

Contact freshcoast customer care for COL requirements, textile testing requirements and yardage requirements for textiles with repeats.

to specify: please refer to pages 3-4 for complete specifying information. Specify all products by their product code.

pricing effective: January 2024

14 inch seat height

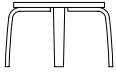

crystal stool	model	list price/grade	list price/edge codes	V2	W2
14" stool, curved plywood base, wood seat	CYS-SH14	18 dia – 18D		\$732	915
		26 dia – 26D		\$822	1025
		36 dia – 36D		\$932	1166

H14



round

18 DIA

26 DIA

36 DIA

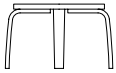

crystal stool	model	list price/grade	com/col	a	b	c	d	e	f	g	h	i	j	k	l
14" stool, curved plywood base, upholstered seat	CYS-SH14	18 dia – 18D	\$966	1008	1029	1051	1073	1093	1115	1137	1158	1180	1199	1221	1243
		26 dia – 26D	\$1076	1132	1161	1190	1218	1247	1276	1303	1332	1361	1389	1419	1447
		36 dia – 36D	\$1215	1300	1343	1386	1429	1471	1515	1557	1600	1642	1686	1729	1771

H14



round

18 DIA

26 DIA

36 DIA

COM yardage: 18 dia: ¾ yd, 26 dia: 1 yd, 36 dia 1½ yds

Contact freshcoast customer care for COL requirements, textile testing requirements and yardage requirements for textiles with repeats.

to specify: please refer to pages 3–4 for complete specifying information. Specify all products by their product code.

pricing effective: January 2024

16 inch seat height

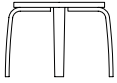

crystal stool	model	list price/grade	list price/edge codes	V2	W2
16" stool, curved plywood base, wood seat	CYS-SH16	18 dia – 18D		\$785	980
		26 dia – 26D		\$874	1093
		36 dia – 36D		\$983	1231

H16



round

18 DIA

26 DIA

36 DIA

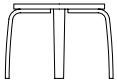

crystal stool	model	list price/grade	com/col	a	b	c	d	e	f	g	h	i	j	k	l
16" stool, curved plywood base, upholstered seat	CYS-SH16	18 dia – 18D	\$1029	1073	1093	1115	1137	1158	1180	1199	1221	1243	1264	1286	1307
		26 dia – 26D	\$1143	1198	1228	1256	1284	1314	1342	1370	1399	1427	1456	1485	1514
		36 dia – 36D	\$1280	1365	1409	1451	1494	1537	1579	1623	1665	1708	1751	1794	1837

H16



round

18 DIA

26 DIA

36 DIA

COM yardage: 18 dia: ¾ yd, 26 dia: 1 yd, 36 dia 1½ yds

Contact freshcoast customer care for COL requirements, textile testing requirements and yardage requirements for textiles with repeats.

to specify: please refer to pages 3–4 for complete specifying information. Specify all products by their product code.

pricing effective: January 2024

18 inch seat height

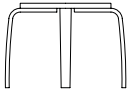

crystal stool	model	list price/grade	list price/edge codes	V2	W2
18" stool, curved plywood base, wood seat	CYS-SH18	18 dia – 18D		\$812	1015
		26 dia – 26D		\$901	1125
		36 dia – 36D		\$1014	1266

H18



round

18 DIA

26 DIA

36 DIA

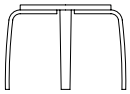

crystal stool	model	list price/grade	com/col	a	b	c	d	e	f	g	h	i	j	k	l
18" stool, curved plywood base, upholstered seat	CYS-SH18	18 dia – 18D	\$1063	1107	1127	1149	1171	1192	1214	1234	1256	1278	1299	1320	1342
		26 dia – 26D	\$1175	1232	1260	1290	1318	1347	1376	1403	1432	1461	1490	1518	1545
		36 dia – 36D	\$1314	1399	1442	1485	1528	1570	1613	1657	1699	1742	1783	1827	1869

H18



round

18 DIA

26 DIA

36 DIA

COM yardage: 18 dia: ¾ yd, 26 dia: 1 yd, 36 dia 1½ yds

Contact freshcoast customer care for COL requirements, textile testing requirements and yardage requirements for textiles with repeats.

to specify: please refer to pages 3–4 for complete specifying information. Specify all products by their product code.

pricing effective: January 2024

freshcoast collection

EVE
CHILDREN'S CHAIR

2024 Price List

Pricing Effective: January 2024



freshcoast
by LELAND

eve children's chair price list

+ eve chair: table of contentsEV2

+ eve chair specification informationEV3

+ eve chair specification example EV5

+ eve 12 inch seat height chair EV6

+ eve 14 inch seat height chairEV7

+ eve 16 inch seat height chair EV8

+ eve 15 inch seat height sled base chair EV9

+ eve task base chair EV10

model

DESCRIPTION	CODE
Eve children's chair	EV
Eve children's chair, upholstered seat pad	EVU

shell style - wetland creatures

DESCRIPTION	CODE	DESCRIPTION	CODE
-------------	------	-------------	------



beaver medium (13) P001



heron aegean (78) P002

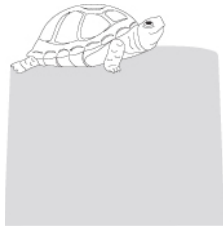

turtle lime (65) P003



frog sea grass (79) P004



duck citrus (73) P005

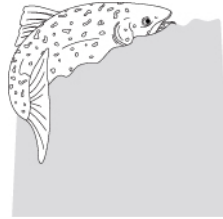

trout cactus (82) P006

shell style - woodland creatures

DESCRIPTION	CODE	DESCRIPTION	CODE
-------------	------	-------------	------

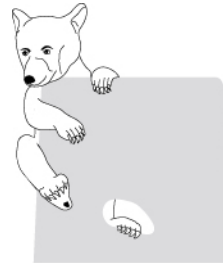

bear medium cherry (17) P007

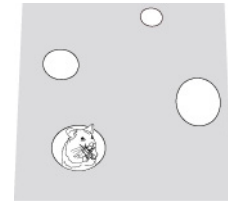

mouse aegean (78) P008



fox scarlet (83) P009



raccoon transparent nocturne (81) P010

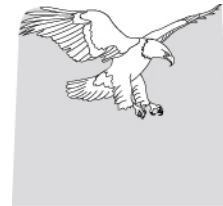

eagle copper (22) P011

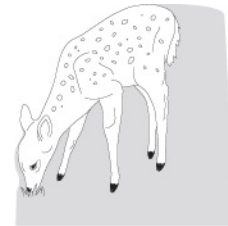

deer terra (84) P012

SPECIFICATIONS CONTINUE ON NEXT PAGE

seat height

DESCRIPTION	CODE
12 inch seat height	SH12
14 inch seat height	SH14
15 inch seat height (wire sled base only)	SH15
16 inch seat height	SH16
13-16 inch seat height (task base only)	HATB

base type

DESCRIPTION	CODE
solid wood	W
4-leg steel	4
wire sled	S
task	T

Black five star task base on hard casters is height adjustable with tilt.

base finish

WOOD

Wood shell and wood base (excluding creature) is finished in Natural (11). Each creature's primary finish color is indicated in parenthesis on the previous page. Please note that freshcoast may use additional color to emphasize details and enhance the appearance of the creature.

4-LEG STEEL & WIRE SLED

DESCRIPTION	CODE	DESCRIPTION	CODE
sterling	ST	limelight textured	LLT
black textured	BT	soda red textured	SRT
white textured	WT	tangerine textured	TNT
dolphin textured	DLT	arctic textured	ART
ink textured	INT	caribbean textured	CBT

TASK

DESCRIPTION	CODE
black	B

upholstered seat pad

Upholstery is Customer's Own Material (COM) requiring ½ yd. per chair.

Due to the design of this product, it is required that all non pre-approved textiles be tested for compatibility. Untested textiles will not be accepted. Contact freshcoast for yardage requirements on textiles with repeats.

Please refer to freshcoast Textile Program which features textiles and leathers from the following partners:

- Camira
- Carnegie
- CF Stinson
- Green Hides
- Maharam
- Unika Vaev

The complete grade list can be found at www.fc.studio/textile-partners or you can specify COM/COL. Due to the design of this product, it is recommended that all non pre-approved textile be tested for compatibility.

SPECIFICATIONS REQUIRED TO CREATE THE PRODUCT CODE

- + **Model**
- + **Shell Style**
- + **Seat Height**
- + **Base Type**
- + **Base Finish**
- + **upholstered seat pad (when applicable)**

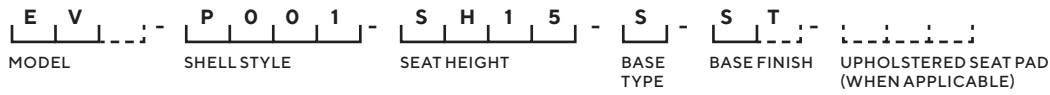

MODEL

Eve children's chair (EV)

SHELL STYLE

Wetland, Beaver (P001)

SEAT HEIGHT

15 inch seat height (SH15)

BASE TYPE

Wire Sled (S)

BASE FINISH

Sterling (ST)



UPHOLSTERED SEAT PAD SELECTION

When applicable

12 inch seat height



eve	model	list
12" seat height, solid wood base	EV-W	\$830

W15.5 D16.5 H23-27*

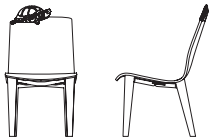

eve	model	com/col	a	b	c	d	e	f	g	h	i	j	k	l
12" seat height, solid wood base, upholstered seat pad	EVU-W	\$931	959	974	989	1004	1018	1034	1047	1062	1077	1091	1107	1121

W15.5 D16.5 H23-27*

COM yardage: ½ yd.
Contact freshcoast customer care for COL requirements, textile testing requirements and yardage requirements for textiles with repeats.



eve	model	list
12" seat height, four leg steel base	EV-4	\$646

W16.5 D18.75 H23-27*



eve	model	com/col	a	b	c	d	e	f	g	h	i	j	k	l
12" seat height, four leg steel base, upholstered seat pad	EVU-4	\$758	786	801	815	829	844	858	872	886	901	915	930	944

W16.5 D18.75 H23-27*

COM yardage: ½ yd.
Contact freshcoast customer care for COL requirements, textile testing requirements and yardage requirements for textiles with repeats.

*overall chair height varies based upon the selected eve creature

to specify: please refer to pages 3-4 for complete specifying information. Specify all products by their product code.

pricing effective: January 2024

14 inch seat height



eve	model	list
14" seat height, solid wood base	EV-W	\$881

W15.75 D16.75 H25-29*

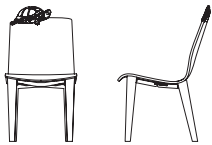

eve	model	com/col	a	b	c	d	e	f	g	h	i	j	k	l
14" seat height, solid wood base, upholstered seat pad	EVU-W	\$979	1008	1021	1037	1051	1064	1079	1093	1108	1122	1137	1150	1164

W15.75 D16.75 H25-29*

COM yardage: ½ yd.
Contact freshcoast customer care for COL requirements, textile testing requirements and yardage requirements for textiles with repeats.



eve	model	list
14" seat height, four leg steel base	EV-4	\$670

W16.75 D19 H25-29*



eve	model	com/col	a	b	c	d	e	f	g	h	i	j	k	l
14" seat height, four leg steel base, upholstered seat pad	EVU-4	\$782	812	826	840	853	869	883	897	911	925	940	954	969

W16.75 D19 H25-29*

COM yardage: ½ yd.
Contact freshcoast customer care for COL requirements, textile testing requirements and yardage requirements for textiles with repeats.

*overall chair height varies based upon the selected eve creature

to specify: please refer to pages 3-4 for complete specifying information. Specify all products by their product code.

pricing effective: January 2024

16 inch seat height



eve	model	list
16" seat height, solid wood base	EV-W	\$913

W16 D17 H27-31*

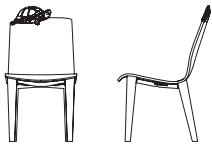

eve	model	com/col	a	b	c	d	e	f	g	h	i	j	k	l
16" seat height, solid wood base, upholstered seat pad	EVU-W	\$1015	1043	1057	1073	1086	1101	1115	1128	1144	1158	1172	1186	1199

COM yardage: ½ yd.
Contact freshcoast customer care for COL requirements, textile testing requirements and yardage requirements for textiles with repeats.

W16 D17 H27-31*



eve	model	list
16" seat height, four leg steel base	EV-4	\$706

W17 D19.25 H27-31*

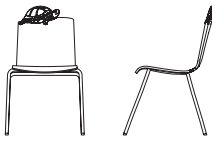

eve	model	com/col	a	b	c	d	e	f	g	h	i	j	k	l
16" seat height, four leg steel base, upholstered seat pad	EVU-4	\$816	845	860	873	887	902	916	931	945	958	973	988	1002

COM yardage: ½ yd.
Contact freshcoast customer care for COL requirements, textile testing requirements and yardage requirements for textiles with repeats.

W17 D19.25 H27-31*

*overall chair height varies based upon the selected eve creature

to specify: please refer to pages 3-4 for complete specifying information. Specify all products by their product code.

pricing effective: January 2024

15 inch seat height - sled base



eve	model	list price/grade	list
15" seat height, wire sled base W16 D18.25 H24-25*	EV-S	black	\$762
		sterling	\$794

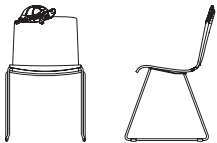

curve	model	list price/grade	com/col	a	b	c	d	e	f	g	h	i	j	k	l
15" seat height, wire sled base, upholstered seat pad W16 D18.25 H24-25*	EVU-S	black	\$873	902	916	931	945	958	973	988	1002	1016	1030	1044	1059
		sterling	\$906	934	948	964	977	991	1005	1019	1034	1048	1062	1077	1090

COM yardage: 1/2 yd.
 Contact freshcoast customer care for COL requirements, textile testing requirements and yardage requirements for textiles with repeats.

*overall chair height varies based upon the selected eve creature

to specify: please refer to pages 3-4 for complete specifying information. Specify all products by their product code.

pricing effective: January 2024

13"-16" adjustable task base chair

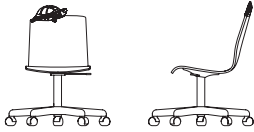

eve	model	list
13"-16" adjustable seat height, task base	EV-T	\$736
W22 D22 H23-31*		

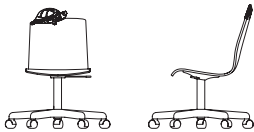

eve	model	com/col	a	b	c	d	e	f	g	h	i	j	k	l
13"-16" adjustable seat height, upholstered seat pad, task base	EVU-T	\$847	875	889	905	918	933	947	960	976	990	1004	1018	1033
W22 D22 H23-31*		COM yardage: ½ yd. Contact freshcoast customer care for COL requirements, textile testing requirements and yardage requirements for textiles with repeats.												

*overall chair height varies based upon the selected eve creature

to specify: please refer to pages 3-4 for complete specifying information. Specify all products by their product code.

pricing effective: January 2024

freshcoast collection
HANDY STOOL

2024 Price List

Pricing Effective: January 2024



handy children's stool price list

+ handy: table of contents HA2
+ handy specifications HA3
+ handy example..... HA4
+ handy stool HA5

model

DESCRIPTION	CODE
Handy Polypropylene	HFC-P

polypropylene shell

DESCRIPTION	CODE
White	WT
Black	BK
Dolphin	DL
Yellow	YL
Orange	OR
Soda Red	SR
Ink	IN
Green	GN

CUSTOM POLYPROPYLENE COLORS

Custom color match is available upon request. Please contact hello@lelandinternational.com for further information

seat height

DESCRIPTION	CODE
12 inch seat height	SH12
14 inch seat height	SH14
16 inch seat height	SH16
17.5 inch seat height	SH17

glide options

DESCRIPTION	CODE
Poly (Standard)	S

stacking note

For Handy, ALL models stack as follows:

Floor: 10 High



	17.5"H	16"	14"	12"
stack of 10:	44"H	42.5"	40.5"	38.5"
stack of 5:	29.5"H	28"	26"	24"

SPECIFICATIONS REQUIRED TO CREATE THE PRODUCT CODE

- + **Model**
- + **Shell Finish**
- + **Seat Height**

H F C - **P** - **S H 1 7** - **W T**
MODEL SEAT HEIGHT COLOR

MODEL

Handy Stool (HFC-P)

SEAT HEIGHT

17.5 inch seat height

POLYPROPYLENE SHELL FINISH

White (WT)





handy stool	model	list
polypropylene shell	HFC-P-SH17	\$199

W15.75 D14.25 H17.5

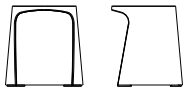

handy stool	model	list
polypropylene shell	HFC-P-SH16	\$199

W15.5 D14.25 H16



handy stool	model	list
polypropylene shell	HFC-P-SH14	\$199

W15.25 D14 H14



handy stool	model	list
polypropylene shell	HFC-P-SH12	\$199

W14.75 D13.75 H12

to specify: please refer to pages 3-4 for complete specifying information. Specify all products by their product code.

pricing effective: January 2024

freshcoast collection
**LITTLE MARQUETTE
CHAIR**

2024 Price List

Pricing Effective: January 2024



little marquette chair pricelist

- + little marquette chair: table of contents MQ2
- + little marquette chair specifications MQ3
- + little marquette chair example MQ4
- + little marquette chair MQ5

model	code
DESCRIPTION Little Marquette chair	MLQ

shell style	code
DESCRIPTION arc	A







DESCRIPTION crescent	C
--------------------------------	---



shell style
DESCRIPTION freshcoast Standard Wood Finishes custom (specify 01)

frame finish			
DESCRIPTION	CODE	DESCRIPTION	CODE
sterling	ST	limelight textured	LLT
black textured	BT	soda red textured	SRT
white textured	WT	tangerine textured	TNT
dolphin textured	DLT	arctic textured	ART
ink textured	INT	caribbean textured	CBT

glide options	code
DESCRIPTION Poly (Standard)	S
Felt	FC

optional back cut-out		
SWAMP THINGS SERIES		code
	lizard	1S
	frog *cutout is off center	2S
	turtle *cutout is off center	3S
	snake	4S

optional back cut-out cont.	
GEOMETRIC SERIES	
	code

▲ ■ ● ▲ ■ shapes 1G

● circle 2G

■ square 3G

▲ triangle 4G

PETROGLYPH SERIES	
	code

 deer 1P

 antelope 2P

 lamb 3P

 horse 4P

CELESTIAL SERIES	
	code

 saturn 1C

 shooting star 2C

 starry night 3C

 moon 4C

specifications required to create the product code

- Model
- Shell Style
- Back Cut-Out
- Shell Finish
- Frame Finish
- Glide Type

M Q L - C - 1 S - 6 4 - S T - 1 ;
MODEL SHELL FINISH BACK CUT-OUT SHELL FINISH FRAME FINISH GLIDE TYPE

MODEL

Little Marquette Chair (MQL)

SHELL STYLE

Crescent (C)

BACK CUT-OUT

Lizard (1S)

SHELL FINISH

freshcoast finish,
sunflower (64)

FRAME FINISH

Sterling (ST)

GLIDE TYPE

Standard (S)





little marquette chair	model	list price
arc shell w16 d19 h28 sh15	MQL-A	
	powder coat frame	\$253
	chrome frame	\$290
	Optional Glides: Add \$8.00 net per chair for a set of four (4).	



little marquette chair	model	list price
crescent shell w16 d19 h28 sh15	MQL-C	
	powder coat frame	\$253
	chrome frame	\$290
	Optional Glides: Add \$8.00 net per chair for a set of four (4).	

to specify: please refer to pages 3–4 for complete specifying information.
Specify all products by their product code.

freshcoast collection
**LITTLE MARQUETTE
TABLE**

2024 Price List

Pricing Effective: January 2024



little marquette table pricelist

- + little marquette table: table of contents MT2
- + little marquette table specifications MT3
- + little marquette table example MT4
- + little marquette table MT5

model **code**

DESCRIPTION
Little Marquette chair MQL

leg finish

DESCRIPTION	CODE	DESCRIPTION	CODE
sterling	ST	limelight textured	LLT
black textured	BT	soda red textured	SRT
white textured	WT	tangerine textured	TNT
dolphin textured	DLT	arctic textured	ART
ink textured	INT	caribbean textured	CBT

top size and shape

DESCRIPTION



round	code	square	code	rectangle	code
36 dia	36 D	36 x 36	3636	30 x 60	3060
42 dia	42D	42 x 42	4242		

top finish or color

DESCRIPTION

wood tops

freshcoast Wood Finishes ([view here](#))
custom (specify 01)

DESCRIPTION

laminate tops

Identify manufacturer, laminate code, & color L

Please refer to the freshcoast Terms and Conditions Guide for a listing of standard laminates. For table pricing in laminates not listed, please contact freshcoast's Customer Experience Department for a quotation.

edge type **code**

DESCRIPTION

vinyl edges

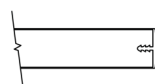

1 3/16" flat PVC V2

wood edges

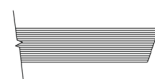

1" beveled plywood W6



1" flat plywood W2

edge finish or color

code

DESCRIPTION

vinyl edges

white	W
black	B
grey	G

DESCRIPTION

wood edges

freshcoast Wood Finishes ([view here](#))
custom (specify 01)

Please note that Marquette Tables are NOT AVAILABLE in the following finishes:
Natural Walnut Matte I08MI. Natural Beech I09I. Natural White Oak Matte I12MI

DESCRIPTION

self edges

For laminate tops, edge must be specified in the same laminate as top surface.

specifications required to create the product code

- Model
- Leg Finish
- Top Size
- Top Finish or Color
- Edge Type
- Edge Finish or Color

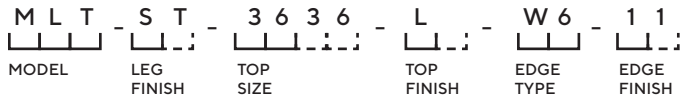

MODEL

Little Marquette Table (MLT)

LEG FINISH

Sterling Powdercoat (ST)

TOP SIZE

Square, 36 x 36 " (3636)

TOP FINISH

Laminate (L)

EDGE TYPE



1" beveled plywood

EDGE FINISH

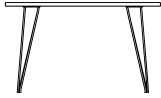

Natural (11)



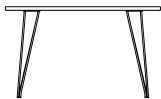

little marquette table	model	top size/code	list price/edge codes	V2	W6	W2
black base h 25  round  square  rectangle 36 dia 36x36 30x60 42 dia 42x42 48 dia 48x48	MLT-B	wood top				
		36 dia - 36D		\$1674	2196	2196
		42 dia - 42D		\$1752	2351	2351
		48 dia - 48D		\$2156	2379	2379
		36x36 - 3636		\$1688	2210	2210
		42x42 - 4242		\$1776	2369	2369
		48x48 - 4848		\$2188	2412	2412
		30x60 - 3060		\$1861	2277	2277
		laminated top				
		36 dia - 36D		\$1479	1859	1859
		42 dia - 42D		\$1776	2051	2051
		48 dia - 48D		\$1799	2086	2086
		36x36 - 3636		\$1497	1876	1876
		42x42 - 4242		\$1795	2076	2076
		48x48 - 4848		\$1836	2124	2124
		30x60 - 3060		\$1663	1892	1892



little marquette table	model	top size/code	list price/edge codes	V6	W6	W2
sterling base h 25  round  square  rectangle 36 dia 36x36 30x60 42 dia 42x42 48 dia 48x48	MLT-ST	wood top				
		36 dia - 36D		\$1848	2369	2369
		42 dia - 42D		\$1928	2526	2526
		48 dia - 48D		\$2331	2557	2557
		36x36 - 3636		\$1860	2386	2386
		42x42 - 4242		\$1948	2543	2543
		48x48 - 4848		\$2365	2592	2592
		30x60 - 3060		\$2037	2451	2451
		laminated top				
		36 dia - 36D		\$1665	2095	2095
		42 dia - 42D		\$1924	2299	2299
		48 dia - 48D		\$1937	2334	2334
		36x36 - 3636		\$1684	2111	2111
		42x42 - 4242		\$1961	2320	2320
		48x48 - 4848		\$1976	2369	2369
		30x60 - 3060		\$1917	2132	2132

to specify: please refer to pages 3-4 for complete specifying information. Specify all products by their product code.

freshcoast collection

**MANITOU
CHILDREN'S CHAIR**

2024 Price List

Pricing Effective: January 2024



freshcoast
by LELAND

manitou children's chair price list







- + manitou chair: table of contents MTC2
- + manitou chair specification information..... MTC3
- + manitou chair specification example MTC4
- + manitou chair shell art options MTC5-MTC6
- + manitou chair, 12 inch seat height..... MTC7
- + manitou chair, 14 inch seat height..... MTC8
- + manitou chair, 16 inch seat height..... MTC9
- + manitou chair, task base MTC10

model



DESCRIPTION	CODE
manitou children's chair, wood face	MTC
manitou children's chair, wood face, upholstered seat pad	MTCU
manitou children's chair, fully upholstered	MTFU

shell style

WOOD SHELL

DESCRIPTION	CODE	DESCRIPTION	CODE
Arch 	AH	Bump 	BP
Dip 	DP	Slant SL 	
Tilt 	TT	Wave 	WV

FULLY UPHOLSTERED SHELL

DESCRIPTION	CODE	DESCRIPTION	CODE
Bump 	BP	Dip 	DP

shell finish or color

TRANSPARENT FINISHES (SEMI-GLOSS SHEEN)

DESCRIPTION	CODE
natural	11M
medium	13M
neutral	15M
white wash II	30M
transparent black	29M
graphite	25M

SEMI-TRANSPARENT FINISHES (MATTE-SHEEN)

DESCRIPTION	CODE
arctic ii	16M
ink ii	18M
limelight	33M
caribbean II	48M
soda red	46M
tangerine	40M
dolphin II	50M

shell art

Select shell art code from the shell art index [here](#) (pages 5 & 6).
Shell art is not available on fully upholstered models.

seat height

4-LEG STEEL BASE

DESCRIPTION	CODE
12 inch seat height	SH12
14 inch seat height	SH14
16 inch seat height	SH16

TASK BASE

DESCRIPTION	CODE
13-16 inch seat height (task base only)	HATB

Black five star task base on hard casters is height adjustable with tilt.

base finish

4-LEG STEEL

DESCRIPTION	CODE	DESCRIPTION	CODE
sterling	ST	limelight textured	LLT
black textured	BT	soda red textured	SRT
white textured	WT	tangerine textured	TNT
dolphin textured	DLT	arctic textured	ART
ink textured	INT	caribbean textured	CBT

TASK

DESCRIPTION	CODE
black	B

upholstery

All upholstery is Customer's Own Material (COM).

Due to the design of this product, it is required that all non pre-approved textiles be tested for compatibility. Untested textiles will not be accepted. Contact freshcoast for yardage requirements on textiles with repeats.

Please refer to freshcoast Textile Program which features textiles and leathers from the following partners:

- Camira
- Carnegie
- CF Stinson
- Green Hides
- Maharam
- Unika Vaev

The complete grade list can be found at www.fc.studio.com/textile-partners or you can specify COM/COL. Due to the design of this product, it is recommended that all non pre-approved textile be tested for compatibility.

SPECIFICATIONS REQUIRED TO CREATE THE PRODUCT CODE

- + **Model**
- + **Shell Style**
- + **Shell Finish or Color**
- + **Shell Art (when applicable)**
- + **Seat Height**
- + **Base Finish**
- + **Upholstered Seat Pad (when applicable)**

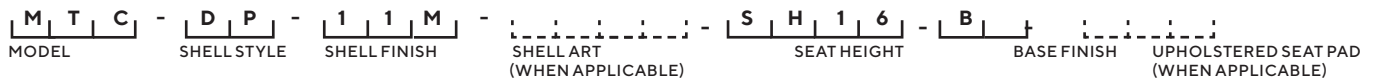

MODEL

Manitou children's chair (MTC)

SHELL STYLE

Dip (DP)

SHELL FINISH OR COLOR

Natural 11M

SHELL ART

Plain Back

SEAT HEIGHT

16 inch seat height (SH16)

BASE FINISH

Black Textured (BT)



UPHOLSTERED SEAT PAD SELECTION

When applicable

freshcoast shell art collections

Please refer to the freshcoast children’s brochure for details on scale and placement of shell art. If no shell art is desired, use code F999.

swamp things

grade 1

description
code



snake
(F001)



lizard
(F002)



tree frog
(F003)

*cutout is off
center



turtle
(F004)

*cutout is off
center

safari

grade 1

description
code



rhinoceros
(F005)



elephant
(F006)



lioness
(F007)



ostrich
(F008)



giraffe
(F009)

petroglyphs

grade 1

description
code



ram
(F010)



antelope
(F011)



deer
(F012)



caribou
(F013)



horse
(F014)

birds

grade 2

description
code



hummingbird
(F015)



owl
(F016)



woodpecker
(F017)



dove
(F018)

celestial

grade 1&2

description
code



moon
(F019)



sun
(F020)
grade 1



star
(F021)



saturn
(F022)



shooting star
(F023)
grade 2



moon among stars
(F024)

Original artwork is property of freshcoast Inc. All rights reserved. No part of this artwork may be reproduced or transmitted in any form or by any electronic means, including photocopying, or by any information or retrieval system, without written permission from the President or Director of freshcoast, Inc.

freshcoast shell art collections, continued

Please refer to the freshcoast children's brochure for details on scale and placement of shell art. If no shell art is desired, use code F999.

sea life
grade 1&2

description
code

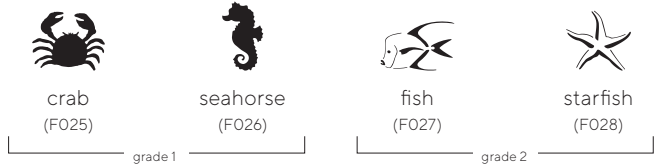

animal tracks
grade 2

description
code



shapes
grade 1

description
code



dinosaurs
grade 1

description
code



insects
grade 1&2

description
code

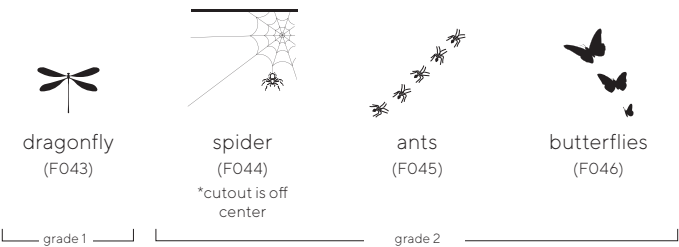

Original artwork is property of freshcoast Inc. All rights reserved. No part of this artwork may be reproduced or transmitted in any form or by any electronic means, including photocopying, or by any information or retrieval system, without written permission from the President or Director of freshcoast, Inc.

12 inch seat height

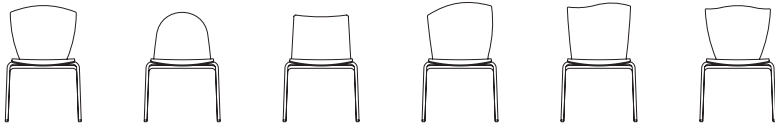

manitou four leg base	model	list price/grade	list
12" seat height, wood back W16.5 D17.5-19* H24.5-27*	MTC-SH12	plain back	\$462
		grade 1 cutout	\$510
		grade 2 cutout	\$594



manitou four leg base	model	list price/grade	com/col	a	b	c	d	e	f	g	h	i	j	k	l
12" seat height, upholstered seat pad W16.5 D17.5-19* H24.5-27*	MTCU-SH12	plain back	\$605	633	647	662	676	691	705	718	733	748	762	776	791
		grade 1 cutout	\$650	679	694	708	721	737	751	765	779	794	808	822	837
		grade 2 cutout	\$736	764	778	793	806	821	836	849	864	878	892	907	921

COM yardage: ½ yd.
Contact freshcoast customer care for COL requirements, textile testing requirements and yardage requirements for textiles with repeats.

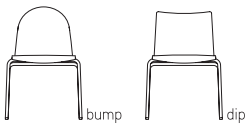

manitou four leg base	model	com/col	a	b	c	d	e	f	g	h	i	j	k	l
12" seat height, upholstered seat pad BUMP W16.75 D19 H23.5 DIP W16.75 D19 H22	MTFU-SH12	\$614	701	743	786	829	872	915	957	1001	1043	1086	1128	1172
		COM yardage: 1½ yd. Contact freshcoast customer care for COL requirements, textile testing requirements and yardage requirements for textiles with repeats.												

* dimension varies based upon the individual shell style

to specify: please refer to pages 3-4 for complete specifying information. Specify all products by their product code.

pricing effective: January 2024

14 inch seat height

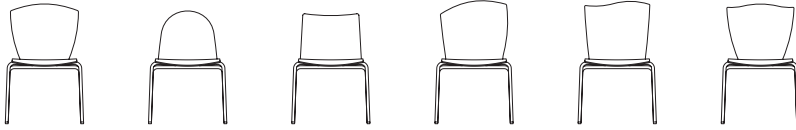

manitou four leg base	model	list price/grade	list
14" seat height, wood back W16.75 D18.5-20* H26.5-29*	MTC-SH14	plain back	\$466
		grade 1 cutout	\$513
		grade 2 cutout	\$598

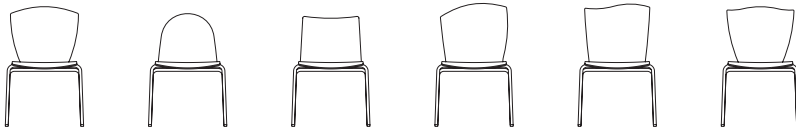

manitou four leg base	model	list price/grade	com/col	a	b	c	d	e	f	g	h	i	j	k	l
14" seat height, upholstered seat pad W16.75 D18.5-20* H26.5-29*	MTCU-SH14	plain back	\$607	635	649	665	678	693	707	720	736	750	764	778	793
		grade 1 cutout	\$656	684	698	713	728	741	755	770	784	799	813	827	841
		grade 2 cutout	\$741	770	784	799	813	827	841	856	870	884	899	912	927

COM yardage: ½ yd.

Contact freshcoast customer care for COL requirements, textile testing requirements and yardage requirements for textiles with repeats.

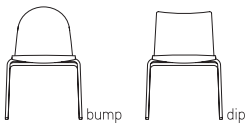

manitou four leg base	model	com/col	a	b	c	d	e	f	g	h	i	j	k	l
14" seat height, fully upholstered BUMP W16.75 D19 H25.5 DIP W16.75 D19 H24	MTFU-SH14	\$620	705	748	791	834	875	918	960	1004	1047	1089	1132	1175
		COM yardage: 1½ yd. Contact freshcoast customer care for COL requirements, textile testing requirements and yardage requirements for textiles with repeats.												

* dimension varies based upon the individual shell style

to specify: please refer to pages 3-4 for complete specifying information. Specify all products by their product code.

pricing effective: January 2024

16 inch seat height

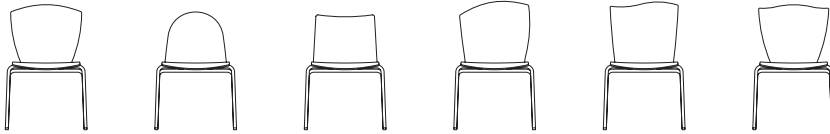

manitou four leg base	model	list price/grade	list
16" seat height, wood back W17 D19-20.5* H27.5-30*	MTC-SH16	plain back	\$468
		grade 1 cutout	\$517
		grade 2 cutout	\$601

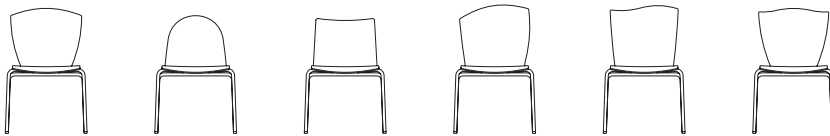

manitou four leg base	model	list price/grade	com/col	a	b	c	d	e	f	g	h	i	j	k	l
16" seat height, upholstered seat pad W17 D19-20.5* H27.5-30*	MTCU-SH16	plain back	\$609	637	652	667	680	695	709	724	738	752	766	780	795
		grade 1 cutout	\$658	686	701	715	730	743	758	773	786	801	815	829	844
		grade 2 cutout	\$743	773	786	801	815	829	844	858	872	886	901	915	930

COM yardage: ½ yd.
Contact freshcoast customer care for COL requirements, textile testing requirements and yardage requirements for textiles with repeats.

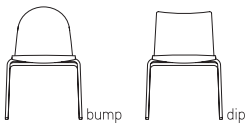

manitou four leg base	model	com/col	a	b	c	d	e	f	g	h	i	j	k	l
16" seat height, fully upholstered BUMP W16.75 D19 H27.5 DIP W16.75 D19 H26	MTFU-SH16	\$624	709	752	795	838	881	923	967	1009	1052	1095	1138	1181
		COM yardage: 1½ yd. Contact freshcoast customer care for COL requirements, textile testing requirements and yardage requirements for textiles with repeats.												

* dimension varies based upon the individual shell style

to specify: please refer to pages 3-4 for complete specifying information. Specify all products by their product code.

pricing effective: January 2024

13"-16" adjustable task base chair

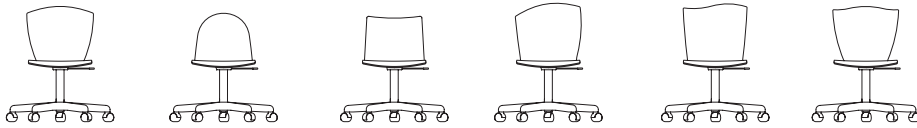

manitou task base	model	list price/grade	list
13-16" adjustable seat height, wood back, task base	MTC-HATB	plain back	\$503
		grade 1 cutout	\$553
		grade 2 cutout	\$588

W22 D22 H*

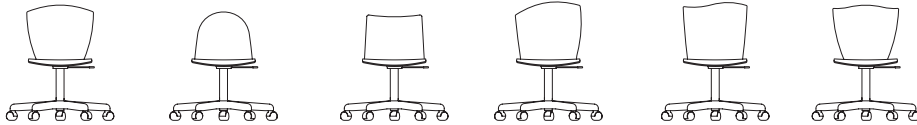

manitou task base	model	list price/grade	com/col	a	b	c	d	e	f	g	h	i	j	k	l
13-16" adjustable seat height, wood back, upholstered seat pad, task base	MTCU-HATB	plain back	\$646	674	690	704	717	732	745	761	775	788	803	817	832
		grade 1 cutout	\$695	724	738	752	766	780	795	809	823	838	851	866	881
		grade 2 cutout	\$731	759	774	787	802	816	830	845	860	873	887	902	916

W16.5 D17.5-19* H*

COM yardage: 1/2 yd.

Contact freshcoast customer car for COL requirements, textile testing requirements and yardage requirements for textiles with repeats.

*varies due to adjustable seat

to specify: please refer to pages 3-4 for complete specifying information. Specify all products by their product code.

pricing effective: January 2024

MTC10

freshcoast collection

**MANITOU
CHILDREN'S TABLE**

2024 Price List

Pricing Effective: January 2024



freshcoast
by LELAND

manitou children's table price list

- + manitou table: table of contents MCT2
- + manitou table specification information MCT3
- + manitou table specification example MCT4
- + manitou table black base MCT5
- + manitou table sterling base MCT6

model

DESCRIPTION	CODE
Manitou children's table	MCT

base finish

DESCRIPTION	CODE	DESCRIPTION	CODE
sterling	ST	limelight textured	LLT
black textured	BT	soda red textured	SRT
white textured	WT	tangerine textured	TNT
dolphin textured	DLT	arctic textured	ART
ink textured	INT	caribbean textured	CBT

top size

ROUND CODE	CODE	SQUARE	CODE	RECTANGLE	CODE
36 dia	36D	36x36	3636	30x60	3060
42 dia	42D	42x42	4242		
48 dia	48D	48x48	4848		

top surface finish or color

WOOD TOP:

TRANSPARENT FINISHES (SEMI-GLOSS SHEEN)

DESCRIPTION	CODE
natural	11M
medium	13M
neutral	15M
white wash II	30M
transparent black	29M
graphite	25M

SEMI-TRANSPARENT FINISHES (MATTE-SHEEN)

DESCRIPTION	CODE
arctic II	16M
ink II	18M
limelight	33M
caribbean II	48M
soda red	46M
tangerine	40M
dolphin II	50M

top surface finish or color, cont.

LAMINATE TOP:

DESCRIPTION	CODE
Identify manufacturer, laminate code, & color	L

Please refer to the freshcoast Terms and Conditions for a listing of standard laminates. For table pricing in laminates not listed, please contact freshcoast for a quotation.

edge type

SOFT VINYL EDGE:

DESCRIPTION	CODE
13/16" flat PVC	V2



WOOD EDGE:

DESCRIPTION	CODE
1" flat plywood	W2



edge finish or color

SOFT VINYL EDGE:

DESCRIPTION	CODE
black	B
white	W
grey	G

WOOD EDGE:

Select from freshcoast Colors

Wood top with wood edge must be specified in the same finish.

Laminate top with wood edge may be specified in any freshcoast finish.

SPECIFICATIONS REQUIRED TO CREATE THE PRODUCT CODE

- + Model
- + Base Finish
- + Top Size
- + Top Surface Finish or Color
- + Edge Type
- + Edge Finish or Color

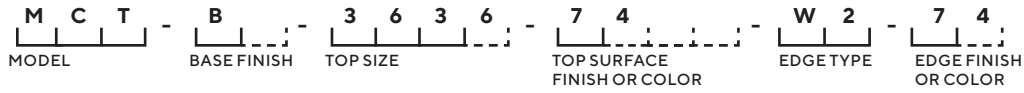

MODEL

Manitou children's table (MCT)

BASE FINISH

Black (B)

TOP SIZE

36 X 36 (3636)

TOP SURFACE FINISH OR COLOR

Concord (74)

EDGE TYPE

1 inch flat plywood (W2)

EDGE FINISH OR COLOR

Concord (74)

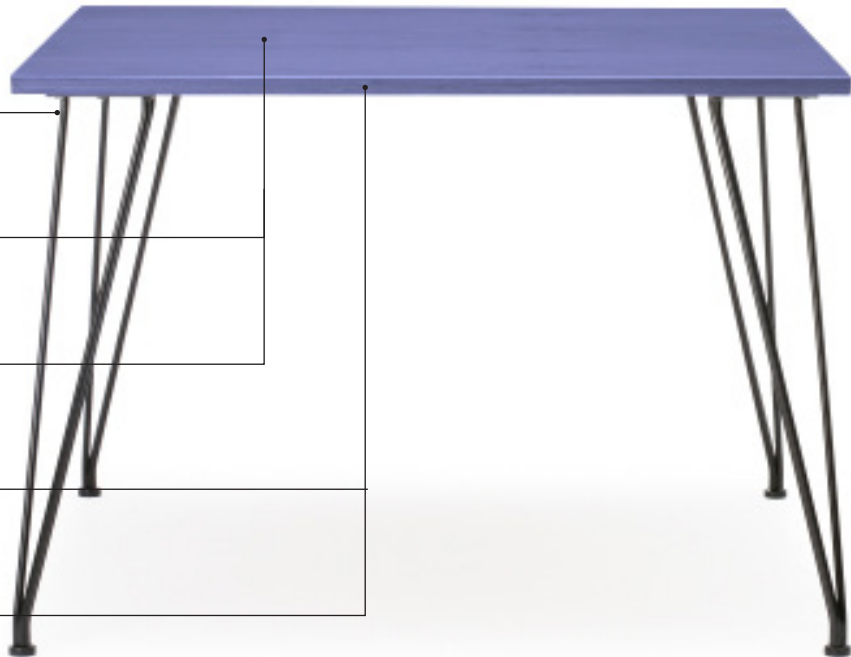

black powder coat base

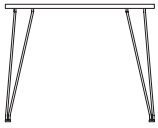

manitou table

4-leg steel black base
H25



model MCT-B

top size/code

list price/edge codes

V2

W2

		
round	square	rectangle
36 DIA	36 x 36	30 x 60
42 DIA	42 x 42	
48 DIA	48 x 48	

wood top

36 dia – 36D	\$1510	1986
42 dia – 42D	\$1580	2127
48 dia – 48D	\$1949	2150
36 x 36 – 3636	\$1521	1997
42 x 42 – 4242	\$1601	2144
48 x 48 – 4848	\$1980	2182
30 x 60 – 3060	\$1683	2057



lamine top

	V2	W2
36 dia – 36D	\$1332	1676
42 dia – 42D	\$1601	1851
48 dia – 48D	\$1624	1884
36 x 36 – 3636	\$1349	1694
42 x 42 – 4242	\$1619	1874
48 x 48 – 4848	\$1656	1919
30 x 60 – 3060	\$1499	1708

to specify: please refer to pages 3–4 for complete specifying information. Specify all products by their product code.

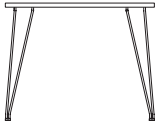
pricing effective: January 2024



manitou table	model	top size/code	list price/edge codes	V2	W2
4-leg steel sterling base H25	MCT-S	wood top			
 round	 square	36 dia – 36D		\$1667	2144
36 DIA	36 x 36	42 dia – 42D		\$1740	2284
42 DIA	42 x 42	48 dia – 48D		\$2109	2318
48 DIA	48 x 48	36 x 36 – 3636		\$1682	2157
		42 x 42 – 4242		\$1758	2302
		48 x 48 – 4848		\$2139	2347
		30 x 60 – 3060		\$1841	2218
		laminare top		V2	W2
		36 dia – 36D		\$1503	1894
		42 dia – 42D		\$1734	2078
		48 dia – 48D		\$1748	2111
		36 x 36 – 3636		\$1517	1907
		42 x 42 – 4242		\$1772	2100
		48 x 48 – 4848		\$1782	2144
		30 x 60 – 3060		\$1732	1926

to specify: please refer to pages 3-4 for complete specifying information. Specify all products by their product code.

pricing effective: January 2024

MCT6

freshcoast collection

**QUINCE
CHILDREN'S CHAIR**

2024 Price List

Pricing Effective: January 2024



freshcoast
by LELAND

quince children's chair price list

- + quince chair: table of contents QC2
- + quince chair specification information QC3
- + quince chair specification example..... QC4
- + quince chair shell art..... QC5-QC6
- + quince 12 inch & 14 inch seat height..... QC7
- + quince 16 inch seat height & task base chair QC8

model

DESCRIPTION	CODE
Quince children's chair, wood face	QC
Quince children's chair, wood face, upholstered seat pad	QCU

shell style

WOOD SHELL

DESCRIPTION	CODE	DESCRIPTION	CODE
Horizon	H	Bump	BP

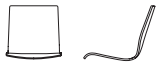

shell finish

DESCRIPTION	CODE	DESCRIPTION	CODE
natural	11M	arctic II	16M
medium	13M	ink II	18M
neutral	15M	limelight	33M
white wash II	30M	caribbean II	48M
transparent black	29M	soda red	46M
graphite	25M	tangerine	40M
		dolphin II	50M

shell art

Select shell art code from the shell art index **here** (pages 5 & 6).

seat height

DESCRIPTION	CODE
12 inch seat height, wood base	SH12
14 inch seat height, wood base	SH14
16 inch seat height, wood base	SH16
13-16 inch seat height (task base)	HATB

Black five star task base on hard casters is height adjustable with tilt.

base finish

WOOD

select from shell finish colors

TASK

DESCRIPTION	CODE
black	B

upholstered seat pad

Upholstery is Customer's Own Material (COM) requiring ½ yd. per chair.

Due to the design of this product, it is required that all non pre-approved textiles be tested for compatibility. Untested textiles will not be accepted. Contact freshcoast for yardage requirements on textiles with repeats.

Please refer to freshcoast Textile Program which features textiles and leathers from the following partners:

- Camira
- Carnegie
- CF Stinson
- Green Hides
- Maharam
- Unika Vaev

The complete grade list can be found at www.fc.studio/textile-partners or you can specify COM/COL. Due to the design of this product, it is recommended that all non pre-approved textile be tested for compatibility.

SPECIFICATIONS REQUIRED TO CREATE THE PRODUCT CODE

- + Model
- + Shell Style
- + Shell Finish
- + Shell Art
- + Seat Height
- + Base Finish
- + Upholstered Seat Pad (when applicable)

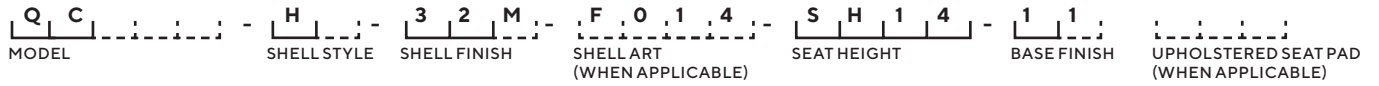

MODEL

Quince children's chair (QC)

SHELL STYLE

Horizon (H)

SHELL FINISH

Ink (32M)

SHELL ART

Petroglyph, Horse (F014)

SEAT HEIGHT

14 inch seat height (SH14)

BASE FINISH

Natural (11)



UPHOLSTERED SEAT PAD SELECTION

When applicable

freshcoast shell art collections

Please refer to the freshcoast children’s brochure for details on scale and placement of shell art. If no shell art is desired, use code F999.

swamp things
grade 1

description
code



snake
(F001)



lizard
(F002)



tree frog
(F003)
*cutout is off
center



turtle
(F004)
*cutout is off
center

safari
grade 1

description
code



rhinoceros
(F005)



elephant
(F006)



lioness
(F007)



ostrich
(F008)



giraffe
(F009)

petroglyphs
grade 1

description
code



ram
(F010)



antelope
(F011)



deer
(F012)



caribou
(F013)



horse
(F014)

birds
grade 2

description
code



hummingbird
(F015)



owl
(F016)



woodpecker
(F017)



dove
(F018)

celestial
grade 1&2

description
code



moon
(F019)



sun
(F020)
grade 1



star
(F021)



saturn
(F022)



shooting star
(F023)
grade 2



moon among stars
(F024)

Original artwork is property of freshcoast Inc. All rights reserved. No part of this artwork may be reproduced or transmitted in any form or by any electronic means, including photocopying, or by any information or retrieval system, without written permission from the President or Director of freshcoast, Inc.

freshcoast shell art collections, continued

Please refer to the freshcoast children's brochure for details on scale and placement of shell art. If no shell art is desired, use code F999.

sea life
grade 1&2

description
code

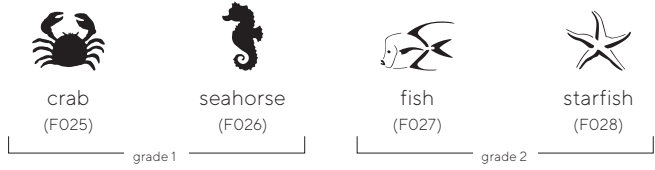

animal tracks
grade 2

description
code



shapes
grade 1

description
code

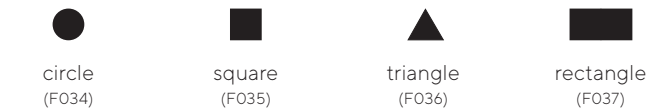

dinosaurs
grade 1

description
code



insects
grade 1&2

description
code

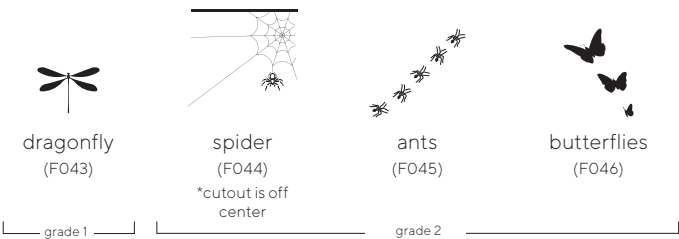

Original artwork is property of freshcoast Inc. All rights reserved. No part of this artwork may be reproduced or transmitted in any form or by any electronic means, including photocopying, or by any information or retrieval system, without written permission from the President or Director of freshcoast, Inc.

12 inch & 14 inch seat height



quince	model	list price/grade	list
12" children's chair, wood shell W15.5 D16.5 H23 SH12	QC-SH12	plain back	\$588
		grade 1 cutout	\$636
		grade 2 cutout	\$676

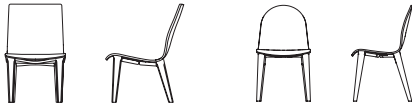

quince	model	list price/grade	com/col	a	b	c	d	e	f	g	h	i	j	k	l
12" children's chair, wood shell upholstered seat pad W15.5 D16.5 H23 SH12	QCU-SH12	plain back	\$736	766	780	795	811	826	840	854	870	885	900	915	930
		grade 1 cutout	\$785	815	830	845	861	875	890	905	919	936	950	965	979
		grade 2 cutout	\$824	853	869	884	899	914	929	943	959	974	988	1004	1018

COM yardage: ½ yd.
Contact freshcoast customer care for COL requirements, textile testing requirements and yardage requirements for textiles with repeats.



quince	model	list price/grade	list
14" children's chair, wood shell W16.75 D16.75 H25 SH14	QC-SH14	plain back	\$626
		grade 1 cutout	\$676
		grade 2 cutout	\$715



quince	model	list price/grade	com/col	a	b	c	d	e	f	g	h	i	j	k	l
14" children's chair, wood shell upholstered seat pad W16.75 D16.75 H25 SH14	QCU-SH14	plain back	\$777	806	822	837	851	866	881	897	911	926	941	955	972
		grade 1 cutout	\$824	853	869	884	899	914	929	943	959	974	988	1004	1018
		grade 2 cutout	\$865	895	910	925	940	954	970	985	1000	1015	1029	1044	1060

COM yardage: ½ yd.
Contact freshcoast customer care for COL requirements, textile testing requirements and yardage requirements for textiles with repeats.

to specify: please refer to pages 3-4 for complete specifying information. Specify all products by their product code.

pricing effective: January 2024

16 inch seat height & 13"-16" adjustable task base chair



quince	model	list price/grade	list
16" children's chair, wood shell W16 D17 H27 SH16	QC-SH16	plain back	\$666
		grade 1 cutout	\$715
		grade 2 cutout	\$754



quince	model	list price/grade	com/col	a	b	c	d	e	f	g	h	i	j	k	l
16" children's chair, wood shell upholstered seat pad W16 D17 H27 SH16	QCU-SH16	plain back	\$814	843	860	874	888	904	918	934	949	964	978	993	1009
		grade 1 cutout	\$865	895	910	925	940	954	970	985	1000	1015	1029	1044	1060
		grade 2 cutout	\$903	932	948	963	977	992	1007	1022	1038	1052	1067	1081	1097

COM yardage: ½ yd.
Contact freshcoast customer care for COL requirements, textile testing requirements and yardage requirements for textiles with repeats.

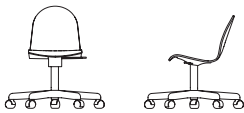

quince	model	list price/grade	list
13"-16" adjustable seat height, wood shell, task base W16.25 D16.25 H24	QC-HATB	plain back	\$700
		grade 1 cutout	\$750
		grade 2 cutout	\$789

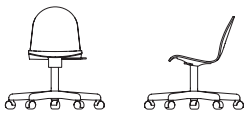

bow	model	list price/grade	com/col	a	b	c	d	e	f	g	h	i	j	k	l
13"-16" adjustable seat height, wood shell, upholstered seat pad, task base W16.25 D16.25 H24	QCU-HATB	plain back	\$849	879	894	909	924	939	953	968	984	999	1013	1028	1043
		grade 1 cutout	\$898	927	942	956	973	987	1002	1017	1032	1047	1062	1077	1091
		grade 2 cutout	\$938	967	982	998	1012	1027	1042	1056	1073	1087	1102	1117	1131

COM yardage: ½ yd.
Contact freshcoast customer care for COL requirements, textile testing requirements and yardage requirements for textiles with repeats.

to specify: please refer to pages 3-4 for complete specifying information. Specify all products by their product code.

freshcoast collection

**QUINCE
CHILDREN'S TABLE**

2024 Price List

Pricing Effective: January 2024



freshcoast
by LELAND

quince children's table price list

- + quince table: table of contents..... QCT2
- + quince table specification information QCT3
- + quince table specification example..... QCT4
- + quince 20"H table QCT5
- + quince 22"H table..... QCT6
- + quince 25"H table..... QCT7

model

DESCRIPTION	CODE
Quince children's table	QCT

table height

DESCRIPTION	CODE
20 inch table height	20H
22 inch table height	22H
25 inch table height	25H

top size

ROUND CODE	CODE	SQUARE	CODE	RECTANGLE	CODE
36 dia	36D	36x36	3636	30x60	3060
42 dia	42D	42x42	4242		
48 dia	48D	48x48	4848		

top surface finish or color

WOOD TOP:

DESCRIPTION	CODE	DESCRIPTION	CODE
natural	11M	arctic ii	16M
medium	13M	ink ii	18M
neutral	15M	limelight	33M
white wash II	30M	caribbean II	48M
transparent black	29M	soda red	46M
graphite	25M	tangerine	40M
		dolphin II	50M

LAMINATE TOP:

DESCRIPTION	CODE
Identify manufacturer, laminate code, & color	L

Please refer to the freshcoast Terms and Conditions for a listing of standard laminates. For table pricing in laminates not listed, please contact freshcoast for a quotation.

edge type

SOFT VINYL EDGE:		WOOD EDGE:	
DESCRIPTION	CODE	DESCRIPTION	CODE
13/16" flat PVC	V2	1" flat plywood	W2

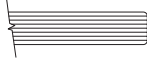
edge finish or color

SOFT VINYL EDGE:	
DESCRIPTION	CODE
black	B
white	W
grey	G

WOOD EDGE:

Select from top surface colors
 Wood top with wood edge must be specified in the same finish.
 Laminate top with wood edge may be specified in any freshcoast finish

base finish

Select from top surface colors

SPECIFICATIONS REQUIRED TO CREATE THE PRODUCT CODE

- + **Model**
- + **Table Height**
- + **Base Finish**
- + **Top Size**
- + **Top Surface Finish or Color**
- + **Edge Type**
- + **Edge Finish or Color**



MODEL

Quince children's table (QCT)

TABLE HEIGHT

25 inch table height (25H)

BASE FINISH

Natural (11)

TOP SIZE

36 dia (36D)

TOP SURFACE FINISH OR COLOR

Laminate (L)

EDGE TYPE

1 inch flat plywood (W2)



EDGE FINISH OR COLOR

Natural (11)



20 inch height



quince table	model	top size/code	list price/edge codes	V2	W2
wood base H20	QCT-20H	wood top			
 round		36 dia – 36D		\$1247	1558
 square		42 dia – 42D		\$1312	1642
 rectangle		48 dia – 48D		\$1331	1663
36 DIA	36 x 36	36 x 36 – 3636		\$1252	1567
42 DIA	42 x 42	42 x 42 – 4242		\$1317	1649
48 DIA	48 x 48	48 x 48 – 4848		\$1338	1671
		30 x 60 – 3060		\$1289	1609
		laminate top			
		36 dia – 36D		\$1122	1400
		42 dia – 42D		\$1180	1477
		48 dia – 48D		\$1197	1497
		36 x 36 – 3636		\$1127	1409
		42 x 42 – 4242		\$1186	1483
		48 x 48 – 4848		\$1208	1508
		30 x 60 – 3060		\$1162	1451



to specify: please refer to pages 3-4 for complete specifying information. Specify all products by their product code.

pricing effective: January 2024

QCT5

22 inch height



quince table		model	top size/code	list price/edge codes	V2	W2
wood base		QCT-22H	wood top			
H22			36 dia – 36D		\$1269	1586
			42 dia – 42D		\$1338	1671
round	square		48 dia – 48D		\$1358	1697
			36 x 36 – 3636		\$1277	1598
36 DIA	36 x 36		42 x 42 – 4242		\$1347	1683
	rectangle		48 x 48 – 4848		\$1364	1707
36 DIA	30 x 60		30 x 60 – 3060		\$1314	1644
42 DIA			laminate top			
48 DIA			36 dia – 36D		\$1142	1430
			42 dia – 42D		\$1208	1508
			48 dia – 48D		\$1223	1526
			36 x 36 – 3636		\$1150	1437
			42 x 42 – 4242		\$1212	1515
		48 x 48 – 4848		\$1227	1536	
		30 x 60 – 3060		\$1182	1479	



to specify: please refer to pages 3-4 for complete specifying information. Specify all products by their product code.

pricing effective: January 2024

QCT6

25 inch height



quince table		model	top size/code	list price/edge codes	V2	W2
wood base		QCT-25H	wood top			
H25			36 dia – 36D		\$1296	1619
			42 dia – 42D		\$1364	1707
round	square		48 dia – 48D		\$1384	1732
			36 x 36 – 3636		\$1304	1630
36 DIA	36 x 36		42 x 42 – 4242		\$1372	1714
	30 x 60		48 x 48 – 4848		\$1391	1740
42 DIA	42 x 42		30 x 60 – 3060		\$1339	1673
48 DIA	48 x 48		laminate top			
			36 dia – 36D		\$1166	1456
			42 dia – 42D		\$1227	1536
			48 dia – 48D		\$1247	1559
			36 x 36 – 3636		\$1173	1466
			42 x 42 – 4242		\$1236	1543
		48 x 48 – 4848		\$1254	1567	
		30 x 60 – 3060		\$1209	1509	

to specify: please refer to pages 3-4 for complete specifying information. Specify all products by their product code.

pricing effective: January 2024

freshcoast collection

**ZOON
CHILDREN'S CHAIR**

2024 Price List

Pricing Effective: January 2024



freshcoast
by LELAND

zoon children's chair price list

- + zoon chair: table of contents ZNC2
- + zoon chair specification information..... ZNC3
- + zoon chair specification example ZNC4
- + zoon chair art..... ZNC5-ZNC6
- + zoon 12 inch & 14 inch seat height chair..... ZNC7
- + zoon 16 inch seat height & task base chair..... ZNC8

model

DESCRIPTION	CODE
Zoon children's chair, wood face	ZNC
Zoon children's chair, upholstered seat pad	ZNCU

shell style

DESCRIPTION	CODE	DESCRIPTION	CODE
Round	R	Square	S
			

shell finish

DESCRIPTION	CODE	DESCRIPTION	CODE
natural	11M	arctic ii	16M
medium	13M	ink ii	18M
neutral	15M	limelight	33M
white wash II	30M	caribbean II	48M
transparent black	29M	soda red	46M
graphite	25M	tangerine	40M
		dolphin II	50M

shell art

Select shell art code from the shell art index [here](#) (pages 5 & 6).
insects, spider (F044) is not available on round shells.

seat height

DESCRIPTION	CODE
12 inch seat height, steel four leg	SH12
14 inch seat height, steel four leg	SH14
16 inch seat height, steel four leg	SH16
13-16 inch seat height (task base only)	HATB

Black five star task base on hard casters is height adjustable with tilt.

base finish

STEEL FOUR LEG

DESCRIPTION	CODE	DESCRIPTION	CODE
sterling	ST	limelight textured	LLT
black textured	BT	soda red textured	SRT
white textured	WT	tangerine textured	TNT
dolphin textured	DLT	arctic textured	ART
ink textured	INT	caribbean textured	CBT

TASK

DESCRIPTION	CODE
black	B

glide color

DESCRIPTION	CODE
red	R
yellow	Y
blue	BL
grey	G
black	B

upholstered seat pad

Upholstery is Customer's Own Material (COM) requiring ½ yd. per chair.

Due to the design of this product, it is required that all non pre-approved textiles be tested for compatibility. Untested textiles will not be accepted. Contact freshcoast for yardage requirements on textiles with repeats.

Please refer to freshcoast Textile Program which features textiles and leathers from the following partners:

- Camira
- Carnegie
- CF Stinson
- Green Hides
- Maharam
- Unika Vaev

The complete grade list can be found at www.fc.studio/textile-partners or you can specify COM/COL. Due to the design of this product, it is recommended that all non pre-approved textile be tested for compatibility.

SPECIFICATIONS REQUIRED TO CREATE THE PRODUCT CODE

- + Model
- + Shell Style
- + Shell Finish
- + Shell Art (when applicable)
- + Seat Height
- + Base Finish
- + Glide Color (when applicable)
- + Upholstered Seat Pad (when applicable)



MODEL

Zoon children's chair (ZNC)

SHELL STYLE

Square (S)

SHELL FINISH

Natural (11)

SHELL ART

Celestial, Saturn (F022)

SEAT HEIGHT

14 inch seat height (SH14)

BASE FINISH

White (W)

GLIDE COLOR

Yellow (Y)



UPHOLSTERED SEAT PAD SELECTION
When applicable

freshcoast shell art collections

Please refer to the freshcoast children’s brochure for details on scale and placement of shell art. If no shell art is desired, use code F999.

swamp things
grade 1

description
code



snake
(F001)



lizard
(F002)



tree frog
(F003)
*cutout is off
center



turtle
(F004)
*cutout is off
center

safari
grade 1

description
code



rhinoceros
(F005)



elephant
(F006)



lioness
(F007)



ostrich
(F008)



giraffe
(F009)

petroglyphs
grade 1

description
code



ram
(F010)



antelope
(F011)



deer
(F012)



caribou
(F013)



horse
(F014)

birds
grade 2

description
code



hummingbird
(F015)



owl
(F016)



woodpecker
(F017)



dove
(F018)

celestial
grade 1&2

description
code



moon
(F019)



sun
(F020)
grade 1



star
(F021)



saturn
(F022)



shooting star
(F023)
grade 2



moon among stars
(F024)

Original artwork is property of freshcoast Inc. All rights reserved. No part of this artwork may be reproduced or transmitted in any form or by any electronic means, including photocopying, or by any information or retrieval system, without written permission from the President or Director of freshcoast, Inc.

freshcoast shell art collections, continued

Please refer to the freshcoast children's brochure for details on scale and placement of shell art. If no shell art is desired, use code F999.

sea life
grade 1&2

description
code

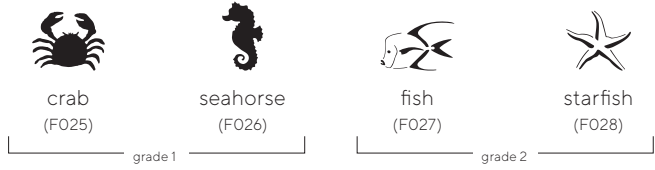

animal tracks
grade 2

description
code



shapes
grade 1

description
code

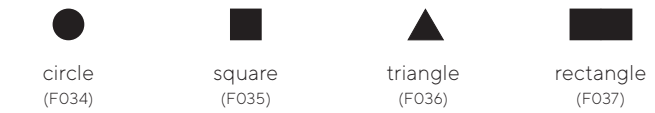

dinosaurs
grade 1

description
code



insects
grade 1&2

description
code

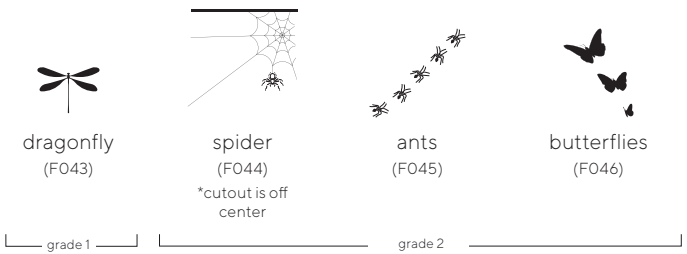

Original artwork is property of freshcoast Inc. All rights reserved. No part of this artwork may be reproduced or transmitted in any form or by any electronic means, including photocopying, or by any information or retrieval system, without written permission from the President or Director of freshcoast, Inc.

12 inch & 14 inch seat height

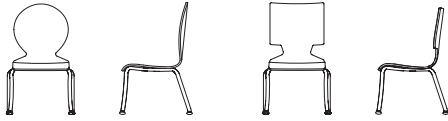

zoon	model	list price/grade	list
12" children's chair, wood shell ROUND W17.25 D16.25 H26.25 SH12 SQUARE W17.25 D16.25 H24.75 SH12	ZNC	plain back	\$386
		grade 1 cutout	\$434
		grade 2 cutout	\$471



zoon	model	list price/grade	com/col	a	b	c	d	e	f	g	h	i	j	k	l
12" children's chair, wood shell upholstered seat pad ROUND W17.25 D16.25 H26.25 SH12 SQUARE W17.25 D16.25 H24.75 SH12	ZNCU	plain back	\$498	526	540	555	569	583	598	611	626	641	655	669	683
		grade 1 cutout	\$543	572	587	601	614	630	644	658	672	686	701	715	730
		grade 2 cutout	\$582	610	625	639	654	668	682	696	710	726	739	753	767
COM yardage: 1/2 yd. Contact freshcoast customer care for COL requirements, textile testing requirements and yardage requirements for textiles with repeats.															



zoon	model	list price/grade	list
14" children's chair, wood shell ROUND W17.5 D16.5 H28.25 SH14 SQUARE W17.5 D16.5 H26.75 SH14	ZNC	plain back	\$415
		grade 1 cutout	\$462
		grade 2 cutout	\$500



zoon	model	list price/grade	com/col	a	b	c	d	e	f	g	h	i	j	k	l
14" children's chair, wood shell upholstered seat pad ROUND W17.5 D16.5 H28.25 SH14 SQUARE W17.5 D16.5 H26.75 SH14	ZNCU	plain back	\$527	556	570	585	599	612	627	642	656	670	684	698	713
		grade 1 cutout	\$575	603	618	632	646	661	674	690	704	717	732	745	761
		grade 2 cutout	\$612	642	656	670	684	698	713	728	741	755	770	784	799
COM yardage: 1/2 yd. Contact freshcoast customer care for COL requirements, textile testing requirements and yardage requirements for textiles with repeats.															

to specify: please refer to pages 3-4 for complete specifying information. Specify all products by their product code.

16 inch seat height & 13"-16" adjustable task base chair

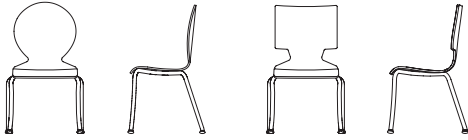

zoon	model	list price/grade	list
16" children's chair, wood shell ROUND W17.75 D16.75 H30.25 SH16 SQUARE W17.75 D16.75 H28.75 SH16	ZNC	plain back	\$455
		grade 1 cutout	\$502
		grade 2 cutout	\$539

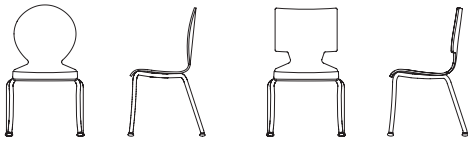

zoon	model	list price/grade	com/col	a	b	c	d	e	f	g	h	i	j	k	l
16" children's chair, wood shell upholstered seat pad ROUND W17.75 D16.75 H30.25 SH16 SQUARE W17.75 D16.75 H28.75 SH16	ZNCU	plain back	\$566	596	609	624	637	652	667	680	695	709	724	738	752
		grade 1 cutout	\$614	644	658	672	686	701	715	730	743	758	773	786	801
		grade 2 cutout	\$650	679	694	708	721	737	751	765	779	794	808	822	837

COM yardage: 1/2 yd.

Contact freshcoast customer care for COL requirements, textile testing requirements and yardage requirements for textiles with repeats.

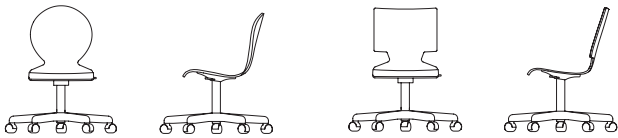

zoon	model	list price/grade	list
13"-16" adjustable seat height, wood shell, task base ROUND W22 D22 H27.25-30.25 SQUARE W22 D22 H25.75-28.75	ZNC	plain back	\$528
		grade 1 cutout	\$576
		grade 2 cutout	\$613

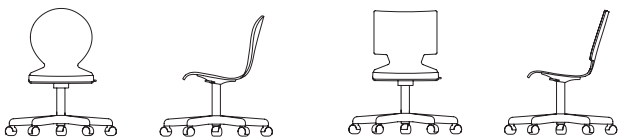

zoon	model	list price/grade	com/col	a	b	c	d	e	f	g	h	i	j	k	l
13"-16" adjustable seat height, wood shell, upholstered seat pad, task base ROUND W22 D22 H27.25-30.25 SQUARE W22 D22 H25.75-28.75	ZNCU	plain back	\$639	668	682	696	710	726	739	753	767	781	797	810	824
		grade 1 cutout	\$689	716	731	744	759	774	787	802	816	830	845	860	873
		grade 2 cutout	\$724	752	766	780	795	809	823	838	851	866	881	895	909

COM yardage: 1/2 yd.

Contact freshcoast customer care for COL requirements, textile testing requirements and yardage requirements for textiles with repeats.

to specify: please refer to pages 3-4 for complete specifying information. Specify all products by their product code.

freshcoast collection
ZOON
CHILDREN'S STOOL

2024 Price List

Pricing Effective: January 2024

fc freshcoast
by LELAND

zoon children's stool price list

- + zoon stool: table of contents ZNS2
- + zoon stool specification information ZNS3
- + zoon stool specification example ZNS4
- + zoon 12 inch & 14 inch seat height stool..... ZNS5
- + zoon 16 inch seat height stool ZNS6

model

DESCRIPTION	CODE
Zoon stool	ZNS

seat height

DESCRIPTION	CODE
12 inch seat height, steel four leg	SH12
14 inch seat height, steel four leg	SH14
16 inch seat height, steel four leg	SH16

base finish

DESCRIPTION	CODE	DESCRIPTION	CODE
sterling	ST	limelight textured	LLT
black textured	BT	soda red textured	SRT
white textured	WT	tangerine textured	TNT
dolphin textured	DLT	arctic textured	ART
ink textured	INT	caribbean textured	CBT

seat finish or color

WOOD SEAT:

DESCRIPTION	CODE	DESCRIPTION	CODE
natural	11M	arctic II	16M
medium	13M	ink II	18M
neutral	15M	limelight	33M
white wash II	30M	caribbean II	48M
transparent black	29M	soda red	46M
graphite	25M	tangerine	40M
		dolphin II	50M

LAMINATE SEAT:

DESCRIPTION	CODE
Identify manufacturer, laminate code, & color	L

Please refer to the freshcoast Terms and Conditions for a listing of standard laminates. For table pricing in laminates not listed, please contact freshcoast for a quotation.

seat finish or color cont.

UPHOLSTERED SEAT:

DESCRIPTION	CODE
Customer's Own Material	COM

Upholstery is Customer's Own Material (COM) requiring ½ yd. per chair.

Due to the design of this product, it is required that all non pre-approved textiles be tested for compatibility. Untested textiles will not be accepted. Contact freshcoast for yardage requirements on textiles with repeats.

Please refer to freshcoast Textile Program which features textiles and leathers from the following partners:

- Brentano
- Camira
- Carnegie
- CF Stinson
- Green Hides
- Maharam
- Unika Vaev

The complete grade list can be found at www.fc.studio/textile-partners or you can specify COM/COL. Due to the design of this product, it is recommended that all non pre-approved textile be tested for compatibility.

edge type

WOOD EDGE:

DESCRIPTION	CODE
1" flat plywood	W2



*upholstered seat does not require an edge selection

edge finish or color

Select from freshcoast Colors I & II.

Wood seat with wood edge must be specified in the same finish.

Laminate seat with wood edge may be specified in any freshcoast finish

glide color

DESCRIPTION	CODE
red	R
yellow	Y
blue	BL
grey	G
black	B

SPECIFICATIONS REQUIRED TO CREATE THE PRODUCT CODE

- + **Model**
- + **Seat Height**
- + **Base Finish**
- + **Seat Finish / Color / Upholstery**
- + **Edge Type (when applicable)**
- + **Edge Finish or Color (when applicable)**
- + **Glide Color**



MODEL

Zoon stool (ZNS)

SEAT HEIGHT

16 inch seat height (SH16)

BASE FINISH

White (W)

SEAT FINISH / COLOR / UPHOLSTERY

Upholstered (COM)

EDGE TYPE

When applicable

EDGE FINISH OR COLOR

When applicable

GLIDE COLOR

Red (R)



12 inch & 14 inch seat height

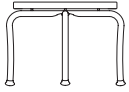

zoon stool	model	list price/grade	list price/edge codes	W2
12 inch seat height, steel four leg base	ZNS-SH12	wood seat		\$304
		laminate seat		\$311

W17.5 D17.5 H12

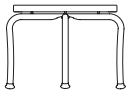

zoon stool	model	list price/grade	com/col	a	b	c	d	e	f	g	h	i	j	k	l
12 inch seat height, steel four leg base, upholstered seat	ZNS-SH12	upholstered seat	\$416	444	458	473	488	501	515	529	543	559	572	587	601
		COM yardage: ½ yd. Contact freshcoast customer care for COL requirements, textile testing requirements and yardage requirements for textiles with repeats.													

W17.5 D17.5 H12

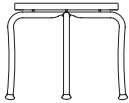

zoon stool	model	list price/grade	list price/edge codes	W2
12 inch seat height, steel four leg base	ZNS-SH14	wood seat		\$315
		laminate seat		\$320

W17.8 D17.8 H14

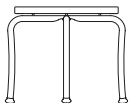

zoon stool	model	list price/grade	com/col	a	b	c	d	e	f	g	h	i	j	k	l
12 inch seat height, steel four leg base, upholstered seat	ZNS-SH14	upholstered seat	\$427	455	469	483	498	512	526	540	555	569	583	598	611
		COM yardage: ½ yd. Contact freshcoast customer care for COL requirements, textile testing requirements and yardage requirements for textiles with repeats.													

W17.8 D17.8 H14

to specify: please refer to pages 3-4 for complete specifying information. Specify all products by their product code.

16 inch seat height

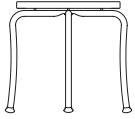

zoon stool	model	list price/grade	list price/edge codes	W2
16 inch seat height, steel four leg base	ZNS-SH16	wood seat		\$324
		laminated seat		\$326

W18.35 D18.35 H16



zoon stool	model	list price/grade	com/col	a	b	c	d	e	f	g	h	i	j	k	l
16 inch seat height, steel four leg base, upholstered seat	ZNS-SH16	upholstered seat	\$435	464	478	493	506	522	536	549	564	578	593	607	622

W18.35 D18.35 H16

COM yardage: 1/2 yd.

Contact freshcoast customer care for COL requirements, textile testing requirements and yardage requirements for textiles with repeats.

to specify: please refer to pages 3-4 for complete specifying information. Specify all products by their product code.

pricing effective: January 2024

freshcoast collection
**ZOON
CHILDREN'S TABLE**

2024 Price List

Pricing Effective: January 2024



freshcoast
by LELAND

zoon children's table price list

- + zoon table: table of contents ZNT2
- + zoon table specification information ZNT3
- + zoon table specification example ZNT4
- + zoon tables ZNT5

model

DESCRIPTION	CODE
Zoon children's table	ZNT

table height

DESCRIPTION	CODE
20 inch table height	20H
22 inch table height	22H
25 inch table height	25H

base finish

DESCRIPTION	CODE	DESCRIPTION	CODE
sterling	ST	limelight textured	LLT
black textured	BT	soda red textured	SRT
white textured	WT	tangerine textured	TNT
dolphin textured	DLT	arctic textured	ART
ink textured	INT	caribbean textured	CBT

top size

ROUND CODE	CODE	SQUARE	CODE	RECTANGLE	CODE
36 dia	36D	36x36	3636	30x60	3060
42 dia	42D	42x42	4242		
48 dia	48D	48x48	4848		

top surface finish or color

WOOD TOP:

DESCRIPTION	CODE	DESCRIPTION	CODE
natural	11M	arctic II	16M
medium	13M	ink II	18M
neutral	15M	limelight	33M
white wash II	30M	caribbean II	48M
transparent black	29M	soda red	46M
graphite	25M	tangerine	40M
		dolphin II	50M

top surface finish or color, cont.

LAMINATE TOP:

DESCRIPTION	CODE
Identify manufacturer, laminate code, & color	L

Please refer to the freshcoast Terms and Conditions for a listing of standard laminates. For table pricing in laminates not listed, please contact freshcoast for a quotation.

edge type

SOFT VINYL EDGE:

DESCRIPTION	CODE
13/16" flat PVC	V2



WOOD EDGE:

DESCRIPTION	CODE
1" flat plywood	W2



edge finish or color

SOFT VINYL EDGE:

DESCRIPTION	CODE
black	B
white	W
grey	G
red	R
blue	BL
yellow	Y

WOOD EDGE:

Select from freshcoast Colors I & II.
 Wood top with wood edge must be specified in the same finish.
 Laminate top with wood edge may be specified in any freshcoast finish

glide color

DESCRIPTION	CODE
red	R
yellow	Y
blue	BL
cool grey	CG
black	B

SPECIFICATIONS REQUIRED TO CREATE THE PRODUCT CODE

- + Model
- + Table Height
- + Base Finish
- + Top Size
- + Top Surface Finish or Color
- + Edge Type
- + Edge Finish or Color
- + Glide Color

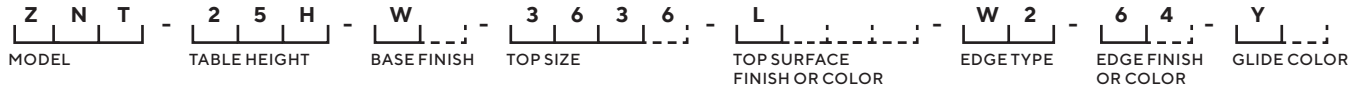

MODEL

Zoon children's table (ZNT)

TABLE HEIGHT

25 inch table height (25H)

BASE FINISH

White (W)

TOP SIZE

36 dia (36D)

TOP SURFACE FINISH OR COLOR

Laminate (L)

EDGE TYPE

1 inch flat plywood (W2)

EDGE FINISH OR COLOR

Sunflower (64)



GLIDE COLOR

Yellow (Y)



20 inch height





zoon table		model	top size/code	list price/edge codes	V2	W2
steel base		ZNT-20H	wood top			
H20			36 dia – 36D		\$1406	1758
			42 dia – 42D		\$1474	1841
round	square		48 dia – 48D		\$1493	1867
			36 x 36 – 3636		\$1416	1767
36 DIA	36 x 36		42 x 42 – 4242		\$1481	1850
	30 x 60		48 x 48 – 4848		\$1499	1875
42 DIA	42 x 42		30 x 60 – 3060		\$1451	1812
48 DIA	48 x 48		laminata top			
			36 dia – 36D		\$1196	1495
		42 dia – 42D		\$1254	1567	
		48 dia – 48D		\$1268	1585	
		36 x 36 – 3636		\$1202	1502	
		42 x 42 – 4242		\$1259	1572	
		48 x 48 – 4848		\$1274	1593	
		30 x 60 – 3060		\$1231	1540	

to specify: please refer to pages 3-4 for complete specifying information. Specify all products by their product code.

pricing effective: January 2024

22 inch height







zoon table		model	top size/code	list price/edge codes	V2	W2
steel base		ZNT-22H	wood top			
H22			36 dia – 36D		\$1443	1801
			42 dia – 42D		\$1511	1886
round	square	rectangle	48 dia – 48D		\$1529	1915
36 DIA	36 x 36	30 x 60	36 x 36 – 3636		\$1451	1812
42 DIA	42 x 42		42 x 42 – 4242		\$1518	1898
48 DIA	48 x 48		48 x 48 – 4848		\$1537	1922
			30 x 60 – 3060		\$1488	1858
			laminite top			
			36 dia – 36D		\$1226	1531
			42 dia – 42D		\$1285	1605
			48 dia – 48D		\$1301	1625
			36 x 36 – 3636		\$1231	1540
			42 x 42 – 4242		\$1291	1612
			48 x 48 – 4848		\$1307	1633
			30 x 60 – 3060		\$1263	1579

to specify: please refer to pages 3-4 for complete specifying information. Specify all products by their product code.

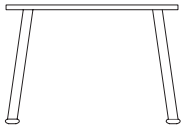
pricing effective: January 2024

25 inch height



zoon table		model	top size/code	list price/edge codes	V2	W2
steel base		ZNT-25H	wood top			
H25			36 dia – 36D		\$1479	1847
			42 dia – 42D		\$1547	1936
round	square		48 dia – 48D		\$1569	1962
			36 x 36 – 3636		\$1485	1858
36 DIA	30 x 60		42 x 42 – 4242		\$1558	1943
42 DIA			48 x 48 – 4848		\$1574	1970
48 DIA			30 x 60 – 3060		\$1523	1904
			laminite top			
			36 dia – 36D		\$1256	1570
		42 dia – 42D		\$1315	1647	
		48 dia – 48D		\$1332	1665	
		36 x 36 – 3636		\$1263	1579	
		42 x 42 – 4242		\$1321	1652	
		48 x 48 – 4848		\$1339	1672	
		30 x 60 – 3060		\$1294	1619	

to specify: please refer to pages 3-4 for complete specifying information. Specify all products by their product code.

pricing effective: January 2024